

Acoustic Simulation's Verification of WFI ATHENA Filterwheel Assembly

Adam PILCH⁽¹⁾, Tadeusz KAMISIŃSKI⁽¹⁾, Mirosław RATAJ⁽²⁾, Szymon POLAK⁽²⁾

⁽¹⁾ *AGH University of Science and Technology*

al. Adama Mickiewicza 30, 30-059 Kraków, Poland; e-mail: {apilch, kamisins}@agh.edu.pl

⁽²⁾ *CBK Space Research Centre*

Bartycka 18A, 00-716 Warszawa, Poland; e-mail: {rataj, spolak}@cbk.waw.pl

(received March 4, 2017; accepted March 28, 2017)

Ariane 5 rocket produces very high sound pressure levels during launch, what can influence structures located in the fairing. To reduce risk of damage, launch in vacuum conditions is preferred for noise sensitive instruments. In Wide Field Imager (WFI) project, the main part of the filterwheel assembly is an extremely thin (~ 240 nm) filter of large area (170×170 mm), very sensitive to noise and vibrations.

The aim of this study was to verify numerical calculations results in anechoic measurements. The authors also checked the influence of WFI geometry and sound absorbing material position on sound pressure level (SPL) affecting the filter mounted inside the assembly. Finite element method (FEM) simulations were conducted in order to obtain noise levels in filter position during Ariane 5 rocket launch. The results will be used in designing of WFI filterwheel assembly and endurance of the filter during launch verification.

Keywords: filterwheel mechanism; FEM acoustic analysis; ATHENA mission; WFI.

1. Introduction

The ATHENA mission is L2 Class mission of ESA's Cosmic Vision programme. Space telescope ATHENA is an X-ray telescope, which maps hot gas structures, determines their physical properties, and search for supermassive black holes.

Wide Field Imager (WFI) – one of the key instruments of ATHENA – will provide imaging in the X-ray energy range of 0.2–15 keV over a field of view with the size of 40 arc min squared in combination with spectral and time-resolved photon counting.

The WFI detector, based on arrays of DEPFET active pixel sensors, apart from sensing X-Rays, is also sensitive to photons in the UV and VIS range. To manage this problem, an appropriate blocking filter is needed for the large field of view detector. Due to the large area/dimension (170×170 mm) and minor thickness (~ 240 nm), the filter of WFI is very vulnerable to acoustic and vibration loads, which are generated during rocket launch. Therefore, the estimation of acoustic load is crucial for designing the WFI Filter Wheel structure.

The main goal of the work is to obtain credible sound pressure levels affecting the filter. The results

will give the input parameters for the filter acoustic simulation, and help to decide if the launch of the module in atmospheric conditions is possible. As it was shown in previous papers (BARBERA *et al.*, 2015; RATAJ *et al.*, 2016), the filterwheel assembly can modify the sound pressure level in the filter position. It is especially dangerous for low frequencies, where the signal can be locally amplified by the assembly resonances, what results in large SPLs.

Ariane 5 launching is very well documented. A lot of work has been done to minimize the impact of the noise produced during the launch on devices under the fairing (GELY *et al.*, 2000; DEFOSSE, HAMDI, 2000; CHEMOUL *et al.*, 2001). Noise level generated by the venting system on the ground does not exceed 94 dB. During the flight, acoustic pressure fluctuations are generated by the working engine and unsteady aerodynamic phenomena characteristic for atmospheric flight. The noise is generated mainly during lift-off and transonic phase (Ariane 5 manual, 2011).

Ariane 5 rocket generates noise at total level of 139.5 dB, measured as an average value in the payload fairing. Spacecraft qualification and acceptance levels are increased by 3 dB. Frequency characteristics of real noise and qualification level are given in Table 1.

Table 1. Sound pressure levels under the fairing in qualification and flight condition for Ariane 5 (Ariane 5 manual, 2011).

Octave band center frequency [Hz]	Qualification level [dB]	Protoflight level [dB]	Flight limit level [dB]
	Ref.: 0 dB = $2 \cdot 10^{-5}$ Pa		
31.5	131	131	128
63	134	134	131
125	139	139	136
250	136	136	133
500	132	132	129
1000	126	126	123
2000	119	119	116
Overall level	142.5	142.5	139.5
Test duration	2 min	1 min	

We can observe the maximum value for the octave band 125 Hz, while for frequencies above 1000 Hz levels are much lower. This is a result of the sound source characteristics as well as acoustic treatment applied in the payload fairing. Surfaces are covered with acoustic panels absorbing high frequencies mainly. For further sound attenuation, especially for lower frequency bands, acoustic resonators are recommended.

2. Methods

2.1. Anechoic condition measurements

In order to obtain precise input parameters for a numerical model, acoustic measurements were performed on a simplified model of the analyzed object.

Model's ribs were replaced with thicker upper and lower plates of the module. The shape of the baffle was also simplified. Parts of the simplified module were connected by bolts, instead of welding, what implied the use of additional elements. Proper thickness of upper plate of the module, i.e. the most important part of the module from structural sound transmission point of view, provides rigidity similar to the rigidity of the ribbed element in the original version. The comparison of the simplified and original model is presented in the Fig. 1. At the present stage of the project, there are two possible geometry options of FWA, called V1 and V3. In option V1, filterwheel is located near the lower part of the FWA, while in option V3 at the top plate of the module. In that option, the airborne sound propagation is limited because the filterwheel blocks the space under the baffle.

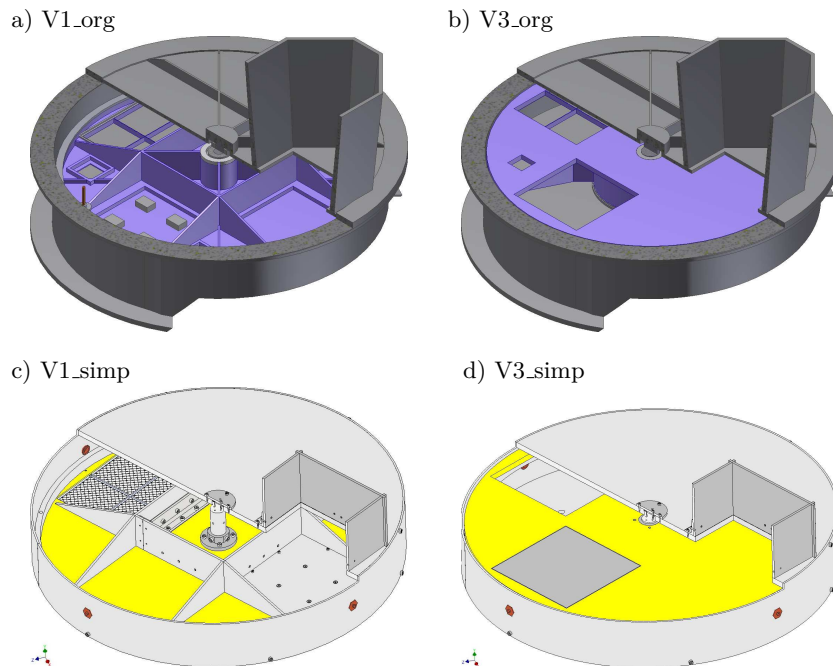

Fig. 1. Comparison of the analyzed geometrical options V1 (a, c) and V3 (b, d) in original (a, b) and simplified (c, d) version.

Table 2. Material parameters adopted in numerical simulation.

Material name	Density	Viscosity/loss factor	Young's modulus	Poisson's ratio	Sound speed
Air	1.2 kg/m ³	1.81 · 10 ⁻⁵ Pa · s	–	–	343 m/s
Aluminum	2700 kg/m ³	0.02	70 · 10 ⁹ Pa	0.33	

The measurements were conducted in an anechoic chamber (SZELAĞ *et al.*, 2014), what allowed to imitate numerical simulation conditions. Signal was generated at 1 m distance from upper surface of FWA, while reference sound pressure level was registered 0.5 m closer. SPL was measured in a position of the filter, using 1/4 inch microphone.

The measurements were repeated for several geometrical variants. For each of them, two kinds of analysis were performed. At first, impulse responses were acquired, in order to extract eigenfrequency of the FWA. Secondly, filtered wide band noise was generated. The shape of the noise frequency characteristics was similar to the one measured in the payload fairing during a launch of Ariane 5 (Table 1). It was assumed that acoustic phenomena were linear at the analyzed levels. In the measurement stand it was impossible to generate noise as loud as during the launch of the rocket. Signal was reduced by 53 dB, with the same frequency characteristics. It was also assumed that protected filter would not influence the sound pressure level inside the analyzed object. Both assumptions were verified in the measurements. Apart from providing calibration data to numerical simulation and validating assumptions mentioned above, measurements were performed to check the effectiveness of the sound absorbing material used inside the FWA. That allows to select a better geometrical option (V1 or V3) and favourable position of the filter during the launch (180° or 90° from the baffle). Finally, the influence of the gap size between filterwheel and top cover of the FWA on the SPL in the filter position was analyzed.

2.2. Numerical simulations

Numerical simulations were performed using Finite Element Method (FEM) applied in Comsol Multiphysics. Material parameters are presented in Table 2. Simulations were made both for the module in a simplified (measured) version and for the original one (Fig. 1).

Aluminum model was immersed in a cylinder shaped air, of a diameter equal to FWA and height equivalent to measurements conditions, i.e. with the sound source at distance of 0.5 m from the top plate of FWA. In Fig. 2 the surface generating sound wave as well as the volume absorbing waves (Perfectly Matched Layer – PML) are marked. It was assumed that acoustic waves affected mainly the top plate of FWA. The bottom plate of the module was fixed. In reality, the

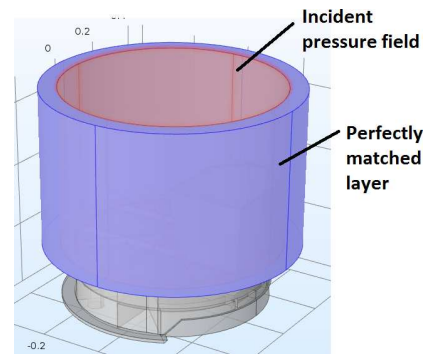

Fig. 2. Model prepared for acoustic simulation. Surface generating incident pressure field and Perfectly Matched Layer were marked.

sound field inside the fairing payload is almost uniform, so the sound affects the whole structure, not only the top plate (compare PIRK *et al.*, 2002). That type of analysis will be made after final validation of numerical model, as anechoic conditions are much easier to be simulated.

Harmonic analysis was made for 73 1/12 octave bands extending from 22 to 1414 Hz. Amplitude of each harmonic signal was consistent with Ariane 5 noise. Results were averaged and presented in 1/1 octave bands.

Finite element mesh was made of 2nd order elements with the maximum dimension lower than 1/6 of the length of the shortest wavelength. In eigenfrequency analysis, 50 lowest values were calculated and their compatibility with measured values was examined.

3. Results

3.1. Anechoic measurements

3.1.1. Influence of filterwheel option (V1, V3) and filter position (90°, 180°)

All measurements results were scaled to the levels generated by rocket Ariane 5 by adding 53 dB. Analysis of the geometries revealed that option V3 (Fig. 3) provides lower sound pressure levels in the position of the filter. For V1 there is an amplification of the sound in the range 125 Hz, where rocket noise is the highest. What is more, poor attenuation of the sound for higher frequencies was observed. Differences between V1 and V3 are greater than 10 dB between 250 and 1000 Hz. Only for octave bands 31.5 and 63 Hz, noise inside V1 option is lower.

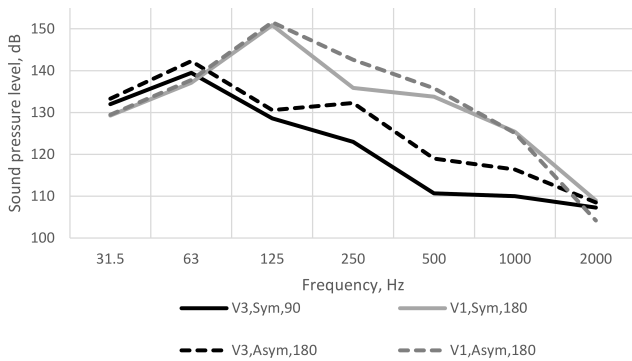

Fig. 3. Comparison of sound pressure level in the filter position for different geometrical options (V1 and V3) and for different filterwheel mass distribution (symmetrical and asymmetrical). The values are scaled to Ariane 5 levels.

Basing on the preliminary acoustic simulations, it was assumed that it was better to put filter further away from the baffle, i.e. in position 180° according to baffle, instead of 90° . Longer distance from the baffle should provide better attenuation of airborne sound influencing the filter area. On the other hand, 180° position of the filter forced asymmetrical mass layout of the filterwheel, what is unfavourable, especially during high amplitude vibrations of the whole system. In the V3 option for filterwheel with symmetrically distributed mass, filter could be mounted at 90° position only. As it could be seen in Fig. 3, in both cases (V1 and V3), lower sound pressure levels were obtained for symmetrical mass distribution. For option V1 the microphone was in the same position (180° in relation to the baffle), so differences result from the mass distribution only. For the asymmetrical version, the filterwheel can be slightly tilted, or even its outer edge can touch the bottom plate of FWA, what results in SPL increase especially for 250 Hz frequency band. For V3 option, measurements were made for two different positions of microphone – 90 and 180° , what could also differentiate the results. Differences were bigger for the whole frequency range than in option V1. Again, symmetrical version resulted in lower SPL values.

3.1.2. Influence of the gap between the filterwheel and the top plate of the FWA

In V3 option, the most important factor affecting the airborne sound in the filter area is the size of the gap between the filterwheel and the top plate of FWA. By changing the position of the washers from above to below the pivot of the filterwheel, the gap size was reduced. Figure 4 presents three curves representing different gap sizes: 3, 2 and 1 mm. The lowest value gives the lowest sound pressure level almost in the whole frequency range. Total SPL of 1 mm gap option was 2.5 dB lower than for 3 mm. However, if the gap is small enough, mechanical contact between the filterwheel and the top plate is more possible, what can

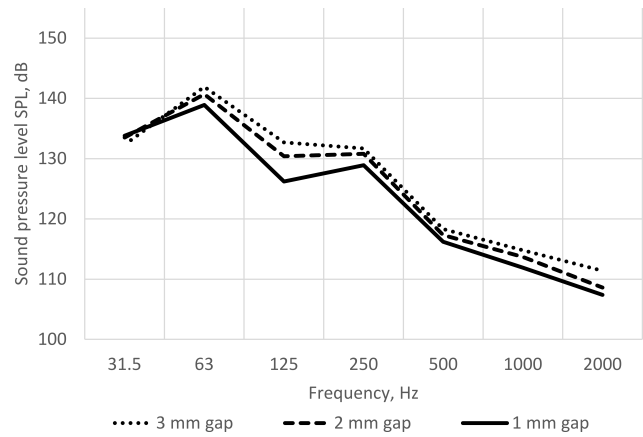

Fig. 4. The influence of the gap size between filterwheel and top plate of FWA. Given values are scaled to Ariane 5 levels.

lead to significantly higher values of structure borne sound in the filter position.

3.1.3. Verification of linearity of the system and lack of filter influence assumption

In order to verify the assumption of linearity of acoustic phenomena inside the FWA, generated signal was decreased by 10 dB (Fig. 5). The maximum deviation of linearity was observed for 2000 Hz – 1.6 dB. For lower frequencies, sound pressure level was 10 dB lower, with maximum error of 0.8 dB for 125 Hz, what can also be a result of the measurement error.

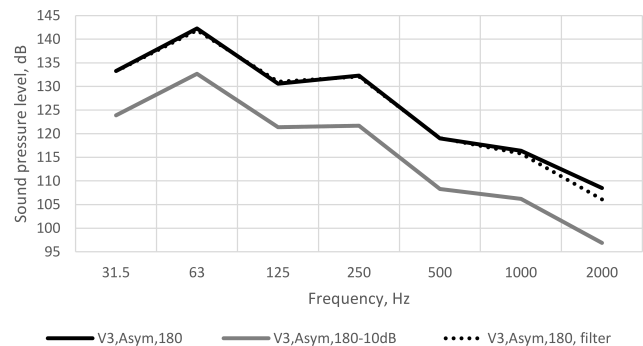

Fig. 5. Verification of linearity of the system and no filter influence assumption. The values are scaled to Ariane 5 levels.

Because of high price of the filter and problems with numerical modelling very thin structures, acoustic simulations as well as measurements were performed without the filter. In order to check its possible influence on the sound field measured nearby, comparative measurements were made for V3 option. The filter was imitated by 0.025 mm thick foil. As it can be observed in Fig. 5, values obtained with and without the foil are almost the same, i.e. between 31.5 and 1000 Hz. The biggest difference in this range is about 0.6 dB. For 2000 Hz, the difference is higher – 2.4 dB, but that

range is not analyzed using the finite element method, as long as it is not dangerous for the filter.

3.1.4. The influence of sound absorbing material

Sound absorbing material used in option V3 does not affect significantly acoustic energy in the filter position (Fig. 6). In both analyzed positions of the absorber – below the baffle and near the filter, it was effective only for 250 Hz frequency band (3 dB) and for high frequency range (1000 Hz), where the SPL reduction was about 6 dB. Lack of sound reduction for lower frequencies was due to a low sound absorption coefficient of used material in that frequency range. Sound resonators should be taken into consideration to reduce the most dangerous frequencies (between 63 and 125 Hz).

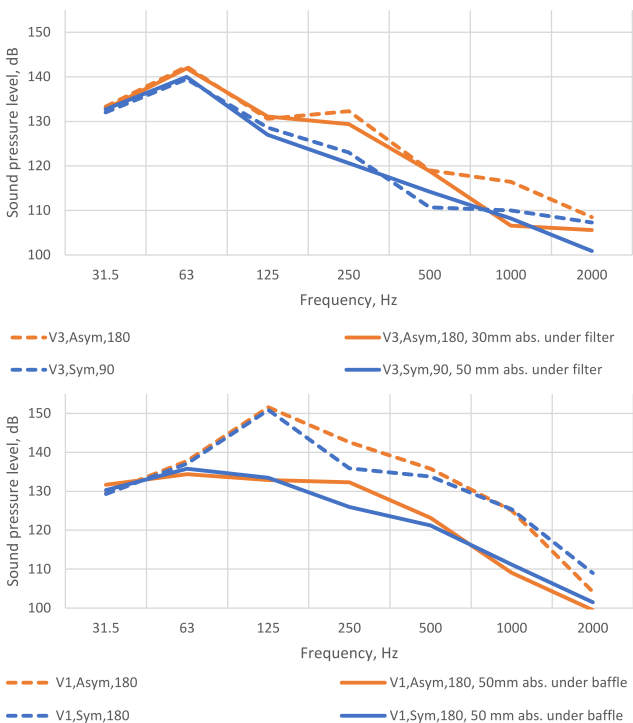

Fig. 6. Influence of sound absorption material on SPL in filter position. On the top, V3 option is presented, on the bottom, V1 option. Given values are scaled to Ariane 5 levels.

For V1 option, sound absorption material was much more effective. Measured values were even 18 dB lower for FWA with absorber (125 Hz), but results are still higher than for V3 option. This is a result of a dominance of airborne sound for V1 option.

3.2. Comparison between numerical simulation and measurements

3.2.1. Eigenfrequencies of the filterwheel assembly (FWA)

Eigenfrequencies were determined by finding the local maxima in frequency characteristics of sound pres-

sure level in the position of the filter. For both geometry options (V1 and V3), the most important values were indicated. In numerical simulation SPL in the filter position was calculated for each of 50 eigenfrequencies and the ones with maximum values were selected.

Table 3 shows eigenfrequencies for V1 and V3 options. Differences between measurements and simulations are significant only for low frequency range. In the case of V3 only the second measured eigenfrequency is much lower than simulated. For middle and high frequency ranges we can observe local maxima of SPL in filter position for similar frequencies both from the measurements and simulations.

Table 3. Comparison of eigenfrequencies measured and calculated in numerical simulation.

V1-sim [Hz]	V1-meas [Hz]	V3-sim [Hz]	V3-meas [Hz]
93	109	48	42
279	275	88	62
293	323	284	276
466	470	439	446
815	824	456	464
954	954	704	690
		864	848
		934	937
		992	1010

3.2.2. FWA under Ariane 5 noise

In comparison of SPL levels in the filter position under Ariane 5 noise, the best consistency for measurements and numerical simulations were obtained for option V1, with mass distributed symmetrically in the filterwheel (Fig. 7). Only for the lowest analyzed octave band (31.5 Hz) some discrepancies could be observed, where measurements gave 15 dB higher values than simulations. It can be caused by the properties of the anechoic chamber where the measurements were made. The cut-off frequency in the chamber is about 80 Hz.

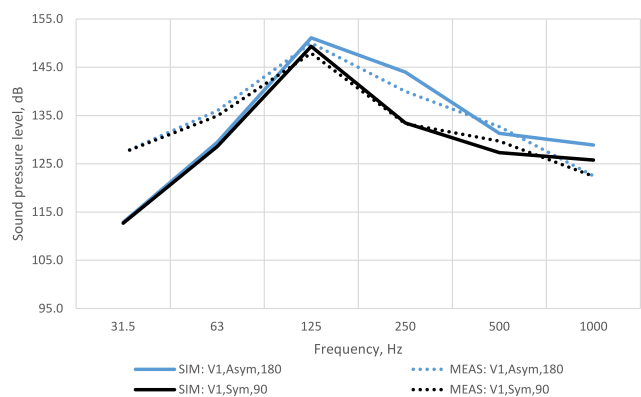

Fig. 7. Comparison of SPL measured (MEAS) and simulated numerically (SIM) in filter position for V1 option. The values are scaled to Ariane 5 levels.

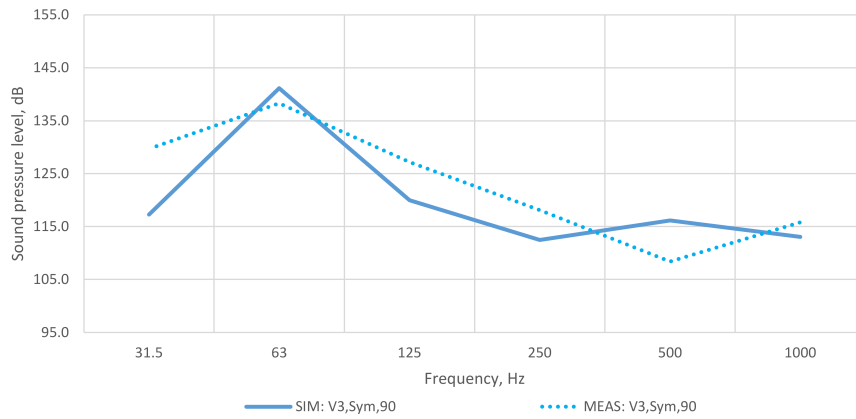

Fig. 8. Comparison of SPL measured (MEAS) and simulated numerically (SIM) in filter position for V3 geometry. Given values are scaled to Ariane 5 levels.

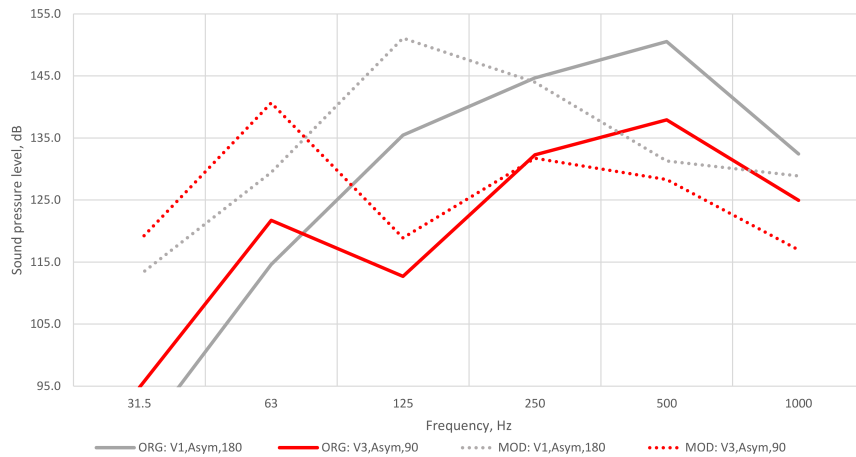

Fig. 9. Sound pressure level comparison simulated numerically in the filter position for V1 and V3 geometry option for original and simplified versions of the model.

The way of fixing the model could also be a source of errors.

More significant differences were observed for V3 option (Fig. 8). Values observed in the filter position were very sensitive for the gap size between filterwheel and the top plate of FWA. Coarse estimation of that value was only possible because of the asymmetrical mass distribution on the filterwheel.

3.3. Compatibility of the FWA simplified model with the original version

Filterwheel assembly was a simplified version of the original project (Fig. 1), introduced in order to reduce costs of model preparation for measurements. Only numerical simulations were made for both simplified and original versions.

As it could be seen in Fig. 9, main resonances of V3 option were similar. For original (ORG) as well as for simplified (MOD) version, there are two local maxima for 63 and 250–500 Hz frequency bands. Properly imitated is also local minimum for 125 Hz, very favourable for dominating rocket noise in this frequency range.

On the other hand, whole frequency characteristic was tilted – in simplified version low frequencies are dominating, while in original one – middle/high frequency range.

In V1 option, global maximum of original version at 500 Hz was moved to 125 Hz frequency range, with almost the same value of sound pressure level (150 dB). Total SPL for both V3 and V1 in a simplified version are respectively 2.3 and 0.3 dB higher than in the original version.

4. Conclusions

Anechoic condition measurements and FEM simulation were performed in order to obtain sound pressure level values affecting the UV filter in the filterwheel assembly during the launch of Ariane 5 rocket. Measurements were made for several options indicating the influence of the following factors on SPL in the filter position:

- size of the gap between the filterwheel and the top plate of FWA (option V3),

- sound absorbing material (option V1),
- mass distribution on the filterwheel.

It was also shown, that the filter itself does not affect SPL values measured in its position. Acoustic phenomena are linear for analyzed ranges of amplitudes, so it is possible to scale measured values to the ones generated during the rocket launch.

FEM simulation resulted in values comparable with the ones obtained in measurements for V1 option. For option V3, possible reasons of discrepancies were pointed. The most important factor was a gap between filterwheel and the top plate of FWA, which was measured with big uncertainty, especially for the filterwheel with asymmetrically distributed mass. Obtained compatibility of measured and calculated values allows to advance the work on FWA using mainly FEM calculation. Numerical comparison of FWA in simplified and original versions revealed almost the same values of total SPL for both geometrical options (V1 and V3), and good agreement of resonance frequencies for option V3. It can be assumed that especially for option V3, factors affecting SPL in the filter position for simplified version of the module are similar to the ones in the original version.

Acknowledgments

This work was supported by grants nr 2015/17/B/ST9/03422 and 2015/18/M/ST9/00541 from National Science Centre. This research was partially supported by PLGrid Infrastructure (Prometheus AGH).

References

1. Arianespace (2011), *Ariane 5 User's Manual*, Arianespace SA.
2. BARBERA M., BRANDUARDI-RAYMONT G., COLLURA A., COMASTRI A., EDER J., KAMISIŃSKI T., LO CICERO U., *et al.* (2015), *The optical blocking filter for the ATHENA wide field imager: Ongoing activities towards the conceptual design*, Proceedings of SPIE – The International Society for Optical Engineering, doi: 10.1117/12.2189326.
3. CHEMAUL B., LOUAAS E., ROUX P., SCHMITT D., POURCHER M. (2001), *ARIANE 5 flight environments*, Acta Astronaut. **48**, 275–285, doi: 10.1016/S0094-5765(01)00026-1.
4. DEFOSSE H., HAMDI M.A. (2000), *Vibro-acoustic study of Ariane V launcher during lift-off*, [In:] INTER-NOISE and NOISE-CON Congress and Conference Proceedings, **2000**, 4, 3574–3582.
5. GELY D., ELIAS G., BRESSON C., FOULON H., RADULOVIC S., ROUX P. (2000), *Reduction of supersonic jet noise – Application to the Ariane 5 launch vehicle*, [In:] 6th Aeroacoustics Conference and Exhibit, 2000–2026, doi: 10.2514/6.2000-2026.
6. PIRK R., DESMET W., PLUYMERS B., SAS P., GOES L.C. (2002), *Vibro-acoustic analysis of the Brazilian vehicle satellite launcher (VLS) fairing*, [In:] Proceedings of the ISMA'2002 – International Conference on Noise and Vibration Engineering, **2**, 2075–2085.
7. RATAJ M., POLAK S., PALGAN T., KAMISIŃSKI T., PILCH A., EDER J. *et al.* (2016), *The filter and calibration wheel for the ATHENA wide field imager*, Proceedings SPIE – Space Telescopes and Instrumentation 2016: Ultraviolet to Gamma Ray, den Herder J-W.A., Takahashi T., Bautz M. [Eds.], **9905**, doi: 10.1117/12.2235411.
8. SZELAŁA A., KAMISIŃSKI T., LEWIŃSKA M., RUBACHA J., PILCH A. (2014), *The Characteristic of Sound Reflections from Curved Reflective Panels*, Archives of Acoustics, **39**, 4, 549–558, doi: 10.2478/aoa-2014-0059.