

## CORRELATIONS OF MECHANICAL PROPERTIES AND MICROSTRUCTURE AT SPECIFIC ZONES OF WELDED JOINT OF HIGH-STRENGTH LOW-ALLOY STEELS

This paper presents experimental testing of the mechanical characteristics and properties of samples made of high-strength low-alloy steel with two different multi pass V groove butt welded joint. Two sample groups are tested: the root pass is made by manual metal arc welding process for the former and metal inert gas welding process for the latter. Other passes of those multi passes welded joints are made by metal active gas welding process. Further, the research included analyses of the experimentally obtained mechanical properties and load response of the samples in correlations to microhardness distribution and microstructural state at specific zones of the welded joints. Since both the chemical composition and microstructural state of high-strength low-alloy steel originate from special production processes their nature must be fully understood. Accordingly, the nature of the steels should directly impact not only the selection and definition of welding but the design process of mechanical constructions, too. From the practical aspect, mechanical characteristics and properties as well as load response of welded joints are crucial. But, sensitivity of those steels to inadequate welding technology and improper parameters or filler metal is high. On the other side, design codes and recommendations are not yet fully developed and precise.

Results obtained in this research implicate that even small changes of welding technology causes the change of characteristics itself. Consequently, the steels development must be accompanied with the improvement of the welding processes and design modifications.

*Keywords:* high-strength low-alloy steel, welded joint, mechanical properties, microstructure

### 1. Introduction

Market demands for higher safety, reliability and construction performances along with reduced prices and higher corrosion and wear resistance dictate high-strength low-alloy steels development and application. Such demands are contradictive and their mutual interactions are complex. Construction design optimization with the usage of the standard materials provides only for partial solutions that are highly limited. Adequate solution to complex set of demands is the application of advanced materials that are lighter with enhanced mechanical properties instead of conventional steels. Current high-strength low-alloy steels are materials that provide for mass reduction, improve energy efficiency and reduce fuel consumption without any compromise on safety and minimal compromise on affordability. Beneficial combination of strength and ductility of those steels is obtained by their microstructure.

High-strength low-alloy steels microstructure results from very large number of factors different by nature and origin with complex interactions. Numerous researches focus on specific microstructure of those steels. Precipitation behaviour strengthening mechanisms during two cooling procedures were systematically analyzed on the basis of the microstructural evo-

lution during research presented in reference [1]. Mechanisms of fracture are analyzed upon combination of fractographs and deflection-load dependences altogether in order to determine optimal cooling rate and best temperature for coiling of those steels.

Alloys design and their thermo-mechanical processing identification is based on fully understanding of microalloying elements effects on high-strength low-alloy steels microstructure. J. Fernández and associates in reference [2] present analysis of effects of microalloying elements on the austenitic grain growth at low carbon high-strength low-alloy steels in order to develop methodology for calculation of solubility of carbides and nitrides in austenite. Jun Hu with associates in reference [3] presents research of correlation between characteristics of cooling process and mechanical properties of hot-rolled low carbon high-strength micro-alloyed steel for vehicle wheel usage. The results indicate best cooling process and its rate in relation to chemical composition and microstructure of steel.

References overview implicates that microstructural state of commercial, general purpose, high-strength low-alloy steels is very complex and sensitive as a result of the specific steels' processing. Technological process of steelmaking utilise two methods for achieving targeted microstructural state: micro alloying and strict control of the rolling temperature i.e. thermo-

\* UNIVERSITY OF KRAGUJEVAC, FACULTY OF ENGINEERING, SESTRE JANJIC 6, 34000 KRAGUJEVAC, REPUBLIC OF SERBIA

# Corresponding author: lozica@kg.ac.rs

mechanically controlled processing. Real mechanical properties of such steels during exploitation depend on large number of factors that are related to their specific applications as well as joining methods, etc. High-strength low-alloy steels must be approached differently from the steels they replace in mechanical constructions. Design of mechanical constructions made of, fully or partially, high-strength low-alloy steels should fully comply with specific characteristics and properties of those steels.

Currently, design codes for application of high-strength low-alloy steels are not fully developed and precise. Joining methods in mechanical constructions made of high-strength low-alloy steels are most critical during both the development of new construction design and their forming. Optimal method of joining is not still achieved in mechanical engineering. Selection of joining method results from multi criteria analysis based on specific design requirements.

In mechanical industry today, welding is dominant joining method for general purpose mechanical constructions. High-strength low-alloy steels welding are still critical despite of their improved weldability that is reason enough for being in focus of research. Welding of those steels is analysed from large number of aspects that are primarily based on relation between welding process and its parameters and obtained mechanical properties of welded joint. Methods and parameters of welding must be selected very carefully since welding cause specific thermal cycles at zones of joint that induce transformation of microstructural state [4].

Lazić with associates in reference [5] gives the estimation of weldability with the selection of the optimal procedure and technology for high-strength low-alloy steels welding. Presented in reference [5] implicate that those problems can mainly be solved by application of the interlayer-rutile soft austenite electrodes and by strict control of heat input.

Specific phenomena caused by thermal cycles at different welded joints zones of high-strength low-alloy steels are in core of researches as their applications increase, welding technology advances and their weldability improve [6].

Mechanical properties of considered steel is obtained by cumulative combination of fine grain size, solid solution strengthening with additional interstitial hardening, precipitation hardening from carbides, dislocation hardening, and mixed microstructure [7]. Ying-Qiao with associates analyses in reference [8] effect of heat input on microstructure and toughness of coarse grain heat affected zone in high-strength low-alloy steel, influence of Niobium on microstructure, transformation kinetics as well as mechanical properties of welded joints done with different heat inputs.

Niobium in solid solution suppresses transformation of ferrite and helps formation of granular bainite for higher heat inputs that cause reduction of impact toughness. For lower heat inputs, formation of low carbon self-tempered martensite in those steels is associated with the higher impact toughness.

Both chemical composition and welding process parameters have high influence on the microstructure and properties of welded joint especially heat affected zone [9]. The size of

the welded zone increases with: greater heat input, hardness of the weld metal and cooling rate [10]. Every process that can be used for welding of high-strength low-alloyed steels has specific influence on microstructure and properties of welded joint. Higher yield strength and higher weld metal hardness in relation to parent metal are obtained by laser and tungsten inert gas welding process. Mechanical properties of weld joints done by metal active gas are reduced and related to lower hardness of weld metal and heat affected zone. It is observed that positions of crack initiation differ depending on the microstructural state of the welded zone, as well as load characteristics [10].

Some problems are still present despite the improved weldability of high-strength low-alloy steels, developed and improved welding methods. High-strength low-alloy steels have low carbon content i.e. low carbon equivalent and high sensitivity to hydrogen cold cracking. The cold cracks usually occur in weld metal, far less in heat affected zone of welded joints. The latter is caused by number of reasons. In order to avoid the former it is necessary to use highly alloyed matching filler material i.e. higher carbon equivalent. Microstructure of weld metal transforms from austenite to ferrite at a lower temperature compared to the parent metal during thermal cycles induced by welding and cooling. Thereby weld metal that is austenitic and has high solubility for hydrogen forms positive environment for the occurrence of cold cracks. Additionally, high strength of the parent metal causes higher level of residual stresses. Different methods are used to enhance the resistance of high-strength low-alloy steels welding joints to cold cracking: preheating at related temperatures to weld metal compositions and welding techniques that reduce the presence of hydrogen at welding zones, etc.

High-strength low-alloy steels have very low level of sulphur content that make them sensitive to solidification cracking in the root pass of butt joints. High dilution of weld metal with low carbon content is the main reason for solidification cracking. Low carbon content, excessive growth of austenite grain and formation of large grains zones increase the risk of solidification cracking.

The microstructural state of heat affected zone is transformed in relation to thermal cycles, chemical composition of parent and filler metal. High heat input causes the growth of metal grain that degrades strength and toughness. On the other side, low heat input during welding causes fusion zone low penetration. Steel producers recommend the use of filler metal, preheating temperatures, limitations for heat input and interpass temperatures in response to chemical compositions and its complex microstructural state together with high sensitivity to heat input.

Applicable norms, standards and recommendations for design of welding joints at high-strength low-alloy steels are based on heterogeneous backgrounds. Also, limitations are set from different reasons in order to provide welded joint with adequate mechanical properties. Methods for improving resistance of welding joints to forming of defect and inclusions are based, primarily, on relaxing residual stress state, reducing hydrogen content and obtaining preferred thermal cycles during welding

and cooling. Due to complexity of factors and their interactions, applicable standards and recommendations are still not fully developed and precise, especially related to effects of specific welding parameters to microstructural state at different zones of welding joints, distribution of microhardness and mechanical properties. Those relations underline the research presented in this paper. Direct influence of welding processes and its parameters to microstructure at specific zones, that is mechanical properties and response to load of welded joints are still not generally researched. From the practical aspect, mechanical characteristics and properties with load response of welded joints at this steel grade are crucial. Only experimental testing can provide relevant data and information about mechanical behaviour of welded joints at high-strength low-alloyed steels during exploitation due to the complex nature of welded joints.

## 2. Experimental details

### 2.1. Testing methodology and samples

Experimental testing procedure is designed and done to provide relevant data and information for analysis of influence of

applied welding technology and its parameters to microstructural state at different zones of welded joints at high-strength low-alloy steels. Multipass butt welded joints are made on 15 mm thick high-strength low-alloy steel plates S690QL with V-grooving. The dimensions of used V-grooves are presented in Fig. 1.

Selection of related filler materials is done on the bases of present standards and recommendations of its producer [4,5,11]. For MMA/MAG group of samples, root pass was done by manual metal arc welding process with shielded electrode INOX 18/8/6 (classification E 18 8 Mn B 22 according to EN 1600), while other passes were done by metal active gas welding procedure with MIG 75, welding wire electrode (classification Mn3Ni-1CrMo according to EN 12534). Root pass for MIG/MAG group of samples was done by metal inert gas welding process with welding wire MIG 18/8/6 Si (classification G 18 8 Mn or W 18 8 Mn according to EN 12072), while other passes were done by the same welding process and with the same filler material as for MMA/MAG group of samples.

The chemical compositions and basic mechanical properties of filler materials are presented in Tab. 1, while values of welding parameters are presented in Tab. 2.

Welded joints are tested for defects and imperfections in order to verify welding and to obtain relevant testing data.

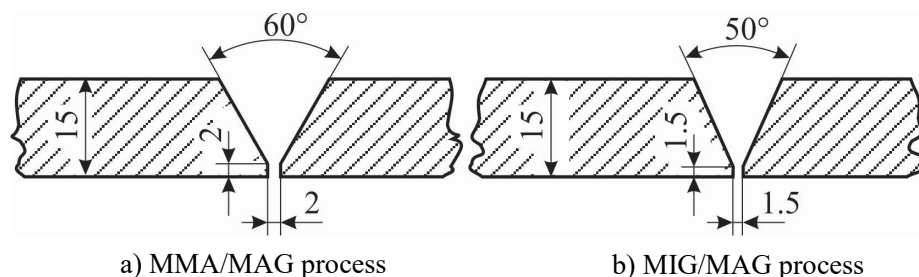

Fig. 1. V-grooves for welding of 15 mm S690QL steel plates

TABLE 1

Chemical compositions and basic mechanical properties of the used filler materials

	Type	Alloying element content [%]						Mechanical properties			
		C	Si	Mn	Cr	Ni	Mo	$R_m$ , MPa	$R_{p0.2}$ , MPa	$A_5$ , %	KV, J
Root passes	INOX B18/8/6	0.12	0.8	1.7	0.19	1.9	—	590 to 690	>350	>40	>80 (+20°C)
	MIG 18/8/6 Si	0.08	0.80	7	18.5	9	—	560 to 660	>380	>35	>40 (+20°C)
Other passes	MIG 75	0.08	0.6	1.7	0.25	1.5	0.3	770 to 940	> 690	> 17	> 47 (-40°C)

TABLE 2

Welding parameters

Parameter	Root pass – MMA/MAG samples	Root pass – MIG/MAG samples	Other passes
Welding current, $I_z$	$I_{z1} \approx 120$ A	$I_{z1} \approx 110$ A	$I_{z2}, I_{z3}, I_{z4} \approx 250$ A
Voltage, $U$	$U_1 \approx 24$ V	$U_1 \approx 24$ V	$U_2, U_3, U_4 \approx 25$ V
Welding speed, $v_z$	$v_{z1} \approx 0.2$ cm/s	$v_{z1} \approx 0.35$ cm/s	$v_{z2}, v_{z3}, v_{z4} \approx 0.35$ cm/s
Input energy, $q_l$	$q_{l1} \approx 12$ kJ/cm	$q_{l1} \approx 13$ kJ/cm	$q_{l2}, q_{l3}, q_{l4} \approx 15$ kJ/cm
Penetration thickness, $\delta$	$\delta_1 \approx 1.8$ mm	$\delta_1 \approx 1.8$ mm	$\delta_2, \delta_3, \delta_4 \approx 1.9$ mm
Filler material feed rate	—	—	8 m/min
Protective gas	—	100% Ar (M11)	Gas mixture M21 – 82% Ar + 18% CO <sub>2</sub>
Protective gas flow	—	14 l/min	14 l/min

### 2.2. Metallurgical testing of welded joints

Metallurgical samples of welded joints zones and samples for tensile testing are prepared according to referent standards and recommendations. Reflective light micrographic method is used for estimation of present microstructural state at specific zones of welded joints. Simultaneously, distributions of microhardness are estimated at three directions, from the sides of root passes, at central zone of cross sections and from the side of weld face. Microhardness are measured by using of diamond pyramided indenter according to present norm SRPS EN ISO 9015-1:2013. Cross sections of the welded joints done by MMA/MAG and MIG/MAG processes prepared for metallurgical testing with positions of microhardness measuring are presented in Fig. 2.

The distributions of microhardness at samples with MMA/MAG and MIG/MAG for direction at side of root pass are presented in Fig. 3.

Obtained distribution of microhardness is in accordance with theoretical considerations in present literature overview related to the area. Higher values at heat affected zones of welded joints done by MIG/MAG processes result from higher input energy, used for those processes. Present microstructural state at coarse grained heat affected zones and transition zone between weld metal and heat affected zones of MMA/MAG welded joint are presented in Fig. 4.

Present microstructure state of coarse grained heat affected zones at considered direction from side of the root pass of MMA/MAG samples presented in Fig. 4a is bainitic without orientation,



Fig. 2. Metallurgical samples of MIG/MAG and MMA/MAG welded joints with directions and positions of microhardness measuring

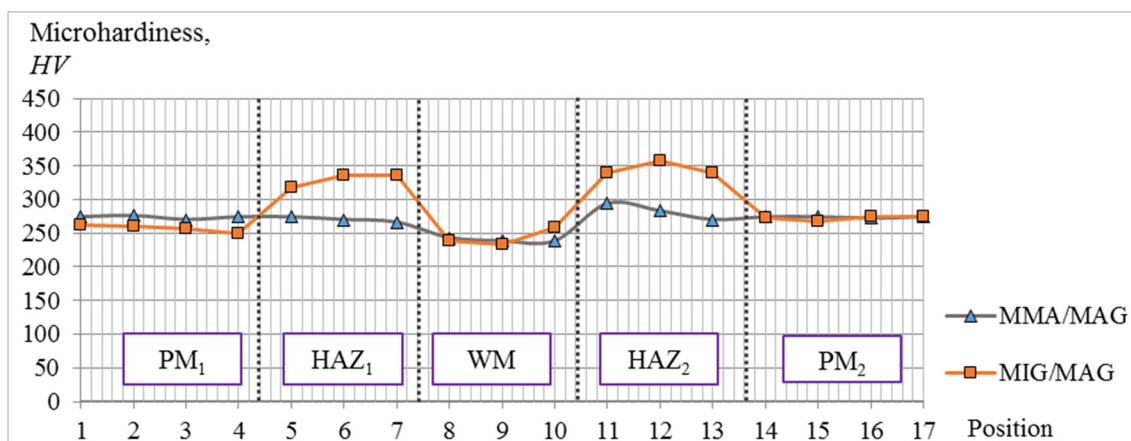
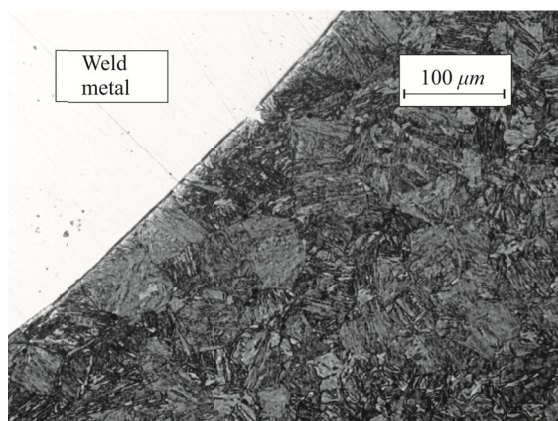
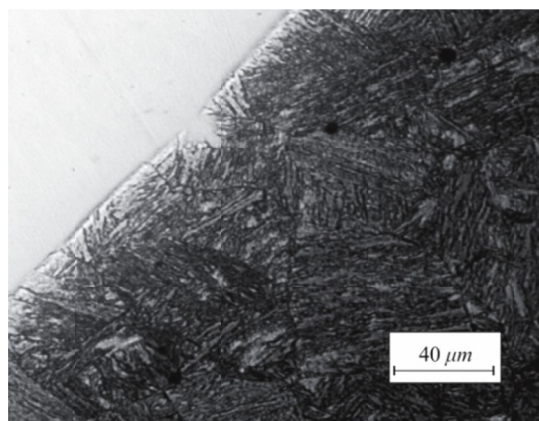

Fig. 3. Distributions of microhardness at direction from side of root pass at MMA/MAG and MIG/MAG samples



a) Coarse grained heat affected zones, magnification 200x



b) Transition zone weld metal/ heat affected zones, magnification 500x

Fig. 4. Microstructure at specific zone of MMA/MAG welded joint

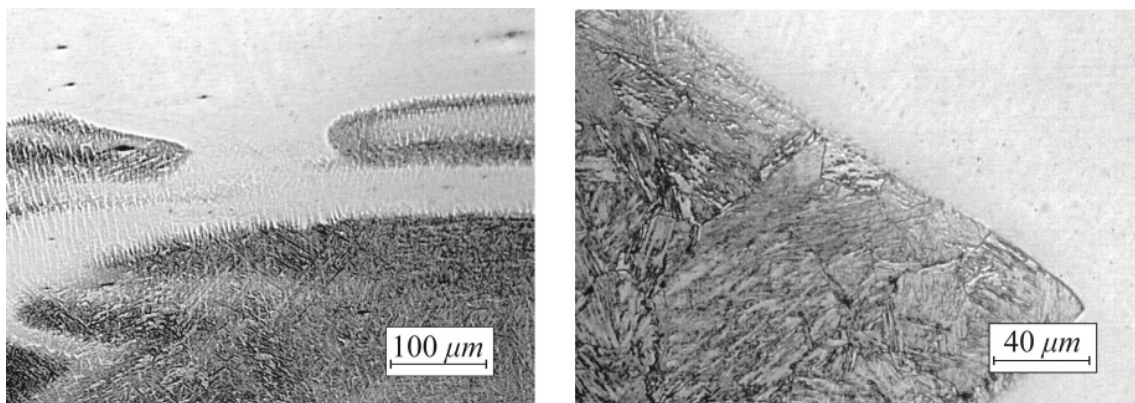

a) Weld metal of root pass, magnification 200x

b) Transition zone heat affected zones /root pass weld metal, magnification 500x

Fig. 5. Microstructure at specific zone of MIG/MAG welded joint

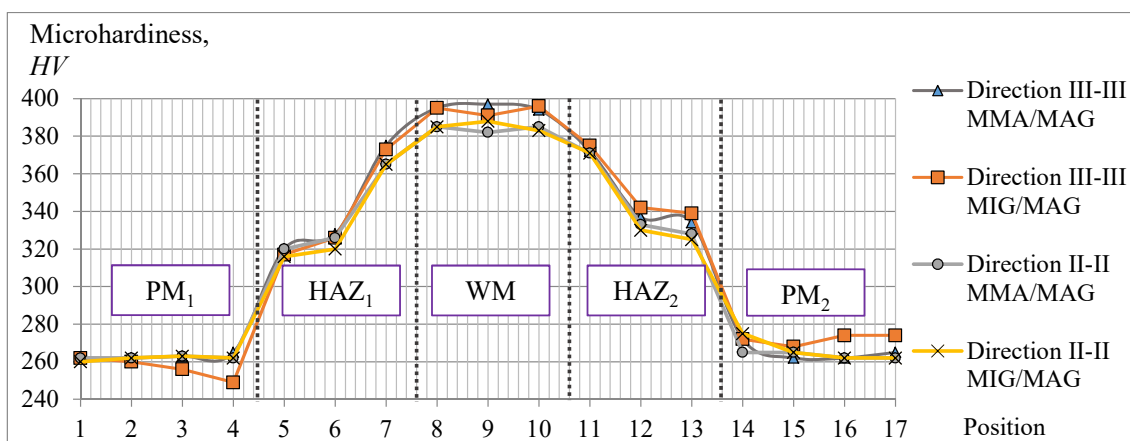

Fig. 6. Distribution of microhardness at MMA/MAG and MIG/MAG welded joints

in accordance with lower values of microhardness in relation to microhardness at other zones of cross section.

Microstructures of weld metal and transition zone between heat affected zones and weld metal at root pass of MIG/MAG are presented in Fig. 5.

Present microstructure state of coarse grained heat affected zones of MIG/MAG welded joint is bainitic without orientation. Weld metal penetration of other passes done by high-alloy filler metal is present. The microstructure is in accordance to values of microhardness. Beneficial microstructure and distribution of microhardness are obtained at samples with MMA/MAG welded joints.

The distributions of microhardness for samples with MMA/MAG and MIG/MAG in direction toward centre and direction facing away from the welded joint are presented in Fig. 6.

The values of microhardness have insignificant mutual variations of higher level than measured at direction from the side of root pass, as it is expected. The microhardness values measured at direction at central zone of cross section showed influence of root passes as expected, slightly higher at welded joint MIG/MAG due to groove dimensions and characteristic of this welding process. The microstructures at weld metal for

both considered welded joints, MMA/MAG and MIG/MAG, are practically the same, presented in Fig. 7.

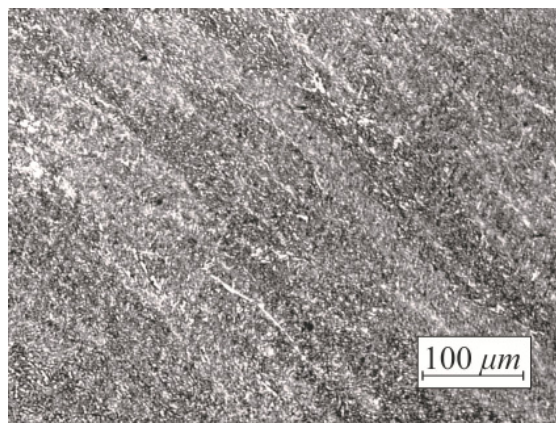

Fig. 7. Microstructure of weld metal at face of welded joint, magnification 200 times

The presented microstructure is coarse grained martensite with presence of bainite. The microstructure of weld metal is slightly finer at MIG/MAG weld joint.

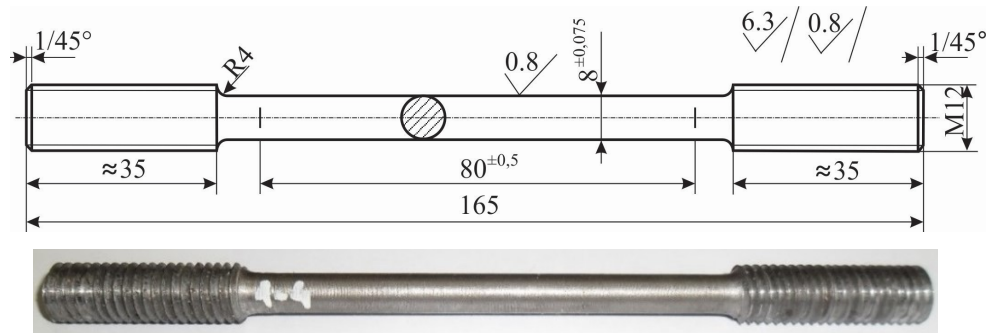

Fig. 8. Tensile testing specimen

### 2.3. Tensile testing of welded joints

Experimental testing is done at room temperature under quasi-static load condition by tensioning to breaking. The testing is done at three different types of samples: one made of considered high-strength low-alloy steel without welded joint, two other with MMA/MAG and MIG/MAG welded joint. The considered welded joints are positioned at central zone of the active part of tensile testing specimens. The dimensions and appearance of samples for tensile testing is presented in Fig. 8.

Values of mechanical characteristics obtained experimentally have insignificant variations and accordingly can be taken as relevant. If testing methodology and sample preparations are adequate then significant variation are caused by welding defects and imperfections. Defects and imperfections are present at welded joints that are done by every technological process and every one of those welding processes has potential risks for occurrence and presence of specific welding defects. Quality of welded joints depend on the number of influential factors, so that the presence of defects and imperfections as a result of those factors is in focus of mechanical construction testing. Welding defects in welded joints are defined and classified in standard EN 26520:1992, while quality of welded joints are defined by EN 25817:1992. Dependence of the force on elongation for tested series of specimens, with and without welded joints under quasi-static loading to breaking are presented in Fig. 9.

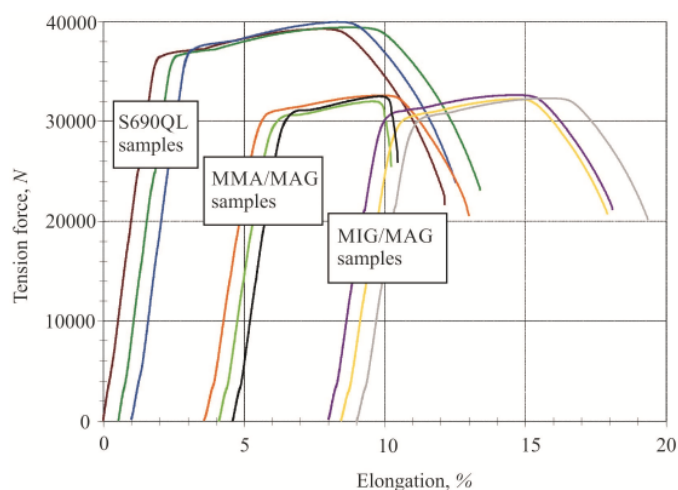

Fig. 9. Force dependence on elongation

Experimentally determined yield and tensile strength at tested specimens made of considered high-strength low-alloy steel S690QL with and without MMA/MAG and MIG/MAG welded joints are presented by histograms in Fig. 10.

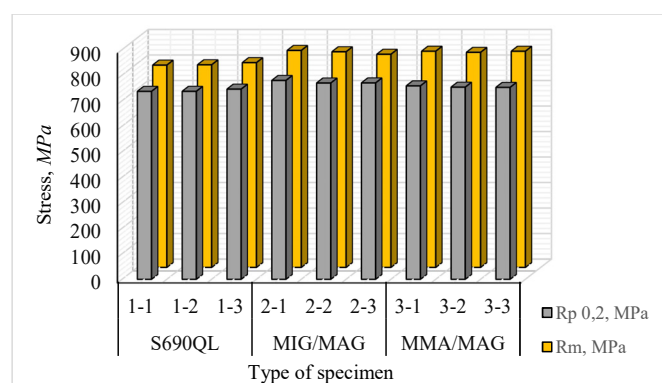

Fig. 10. Basic mechanical properties of specimens

By comparison of values presented in Fig. 10 it can be concluded that mechanical properties of the specimens without welded joint under static load conditions remain within limits determined by testing of specimens without welded joint. Positions of breaking zones out of welded joints at parent metal are indications of adequate welding processes and its parameters. Accordingly it is indicated that stress concentration due to presence of welded joints is insignificant under static load conditions. Mechanical load response of welded joint specimens during testing is in accordance with the acting of the base metal specimens without a welded joint, from the aspect of force dependence on elongation. Specific zones are indicated during analysis of force dependence on elongation at specimens with welded joint, MMA/MAG and MIG/MAG: zone of proportional elongation, zone of plastic deformations that start with yield zone, zone of force increment till reaching of maximal force and breaking force. Experimentally obtained values of elongation to breaking expressed in percentages are presented by histograms in Fig. 11.

On the basis of the elongation values presented in Fig. 11 it can be concluded that elongation of the specimens with both considered types of welded joints, from the aspect of elastic properties, is less than related elongation at specimens made without welded joint. Elongation to breaking of specimens with welded

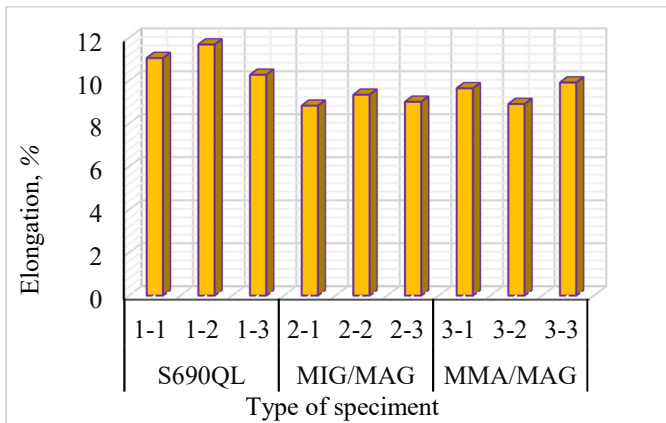

Fig. 11. Elongation to breaking at specimens without and with welded joint

joint MIG/MAG and MMA/MAG are almost the same. This fact is in accordance to relevant literature overview. Specimens with welded joint after testing are presented in Fig. 12.

Position and appearance of breaking surface indicate that breaking happened away from zone of welded joint. The appearance of breaking zone indicates necking with elastic deformations. The appearance of breaking surface indicate two zones of breaking – brittle and plastic zone, i.e. mixed type of breaking.

### 3. Results and discussion

Microhardness measured at specific zones of welded joint do not exceed value that indicates the formation of brittle microstructure proving that the applied welding technology and its parameters are adequate. Microhardness distribution has higher measured values at the MIG/MAG samples heat affected zone than MMA/MAG samples. This fact correlates with lower heat input during MMA/MAG welding. Microstructure of heat affected zones of MMA/MAG welded joint is bainitic without orientation. Such microstructure is finer grained compared to MIG/MAG welded joint. Primarily this applies to both rough thermal cycles during MIG/MAG and specific characteristics of the welding process. The measured values of yield and tensile strength are in accordance with microstructure. Those values are higher for MIG/MAG samples than for MMA/MAG. MMA/MAG samples have higher elongation to fracture due to finer grained microstructure than at MIG/MAG. The differences of mechanical properties among MIG/MAG and MMA/MAG sam-

ples are not significant due to dominant influence of filling welding passes and high strength of related filler material. Almost same microstructures and values of microhardness measured in direction towards centre zone and in direction towards the face of welded joints are expected due to same welding process used for other passes of considered multipass welded joints. Furthermore, both the insignificant degradation of mechanical properties and the same character of mechanical load response at samples made of parent material and at samples with both type of welded joint showed that applied welding technologies are adequate. Analyses of correlations in this research open possibilities for more comprehensive and systematic approach that must enclose precise determination of thermal cycles due to applied welding technology. From the aspect of mechanical properties MIG/MAG welded joint is better, but the fact remains that the identification of proper welding process is complex, multi objective analysis.

### 4. Conclusions

Existing high-strength low-alloy steels are of good welding abilities. But, welding of those steels assume the use of a very strict diapason of welding parameters. This increases the risk that welding parameters will exceed the limits. Due to specific differences of characteristics and properties require modification and adjustment of design codes and recommendations for this steel grade. Additionally, design codes and recommendation of welded joints at those steels are related to parent material rather than to filler metal. The results of the research presented in this paper indicate that selection of filler material, welding technology and its parameters are main influential factor to obtaining appropriate microstructure, mechanical characteristics and properties of welded joints at high-strength low-alloy steels [12,13]. Welding methodologies with lower heat input are more advantageous from the aspect of microstructural degradation. As for multipass welded joints special attention must be paid to the selection of root pass welding technology. Beneficial mechanical properties are obtained from the use of lower strength filler material for the root pass and high strength filler material for other passes.

The application of existing generation of high-strength low-alloy steels is the main consideration of this paper. Prospective properties of the future generations of high-strength low-alloy steels will enhance its application at the mechanical

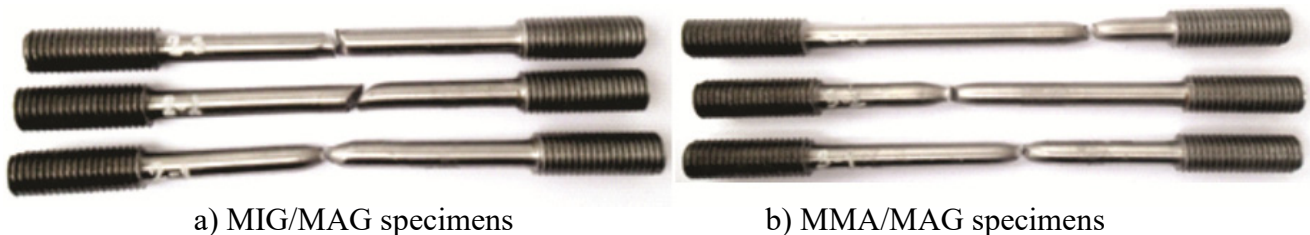

Fig. 12. Specimens with welded joint after testing

constructions. Future perspectives and design optimizations will be still depend on welding. Evolution and upgrading of welding along with design codes and procedures modifications design must follow the evolution of high-strength low-alloy steels [14]. Accordingly the latter approach provides uniquely higher safety and load capacity, low weight, improved environmental compatibility, decreased fuel consumption of general purpose mechanical constructions made of high-strength low-alloy steels.

#### Acknowledgements

This paper presents the research results obtained within the framework of the projects TR-35021 and TR-35033 financially supported by the Ministry of Education, Science and Technological Development of the Republic of Serbia.

#### REFERENCES

- [1] H. Xie, L.X. Du, J. Hua, R.D.K. Misra, *Materials Science&Engineering A* **612**, 123-130 (2014).
- [2] J. Fernández, S. Illescas, J.M. Guilemany, *Materials Letters* **61**, 2389-2392 (2007).
- [3] J. Hua, L.X. Dua, J.J. Wang, Q.Y. Sun, *Materials and Design*. **53**, 332-337 (2014).
- [4] K.Y. Benyounis, A.G. Olabi, *Advances in Engineering Software* **39**, 483-496 (2008).
- [5] V. Lazić, S. Aleksandrović, R. Nikolić, R. Prokić-Cvetković, O. Popović, D. Milosavljević, R. Čukić, *Procedia Engineering* **40**, 310-315 (2012).
- [6] Y. Shi, Z. Han, *Journal of Materials Processing Technology* **207** (1-3), 30-39 (2008).
- [7] S. Shanmugam, N.K. Ramiseti, R.D.K. Misra, J. Hartmann, S.G. Jansto, *Materials Science and Engineering A* **478** (1), 26-37 (2008).
- [8] Y.Q. Zhang, H.Q. Zhang, I.F. Li, W.R. Liu, *Journal of iron and steel research. Int.* **16** (5), 73-80 (2009).
- [9] X.W. Chen, G.Y. Qiao, X.I. Han, X. Wanga, F.R. Xiao, B. Liao, *Materials and Design* **53**, 888-901 (2014).
- [10] H.L. Jeong, S.H. Park, H.S. Kwon, G.S. Kim, C.S. Lee, *Materials and Design* **64**, 559-565 (2014).
- [11] M. Jovanović, V. Lazić, *Instructions for welding of high strength steels: Weldox 700, 2008*, Faculty of Mechanical Engineering, Kragujevac (In Serbian).
- [12] A. Ilić, L. Ivanović, D. Josifović, V. Lazić, *Machine and industrial design in mechanical engineering – KOD 2012*, Proceedings, University of Novi Sad, Faculty of Technical Sciences, Slovak University of Technology in Bratislava, Faculty of Mechanical Engineering, 501-506 (2012) ISBN: 978-86-7892-399-9.
- [13] A. Ilić, L. Ivanović, D. Josifović, V. Lazić, *Innovative Automotive Technology-IAT 2012*, Proceedings, University of Ljubljana, Faculty of Mechanical Engineering, 51-58 (2012) ISSN: 1408-1679.
- [14] S.A. David, T. Debroy, J. Dupont, T. Koseki, H. Smartt, *Trends in Welding Research*, Proceedings of the 7th International Conference, American Welding Society, USA 2007.