

A Digitally Controlled Model of an Active Ultrasonic Transducer Matrix for Projection Imaging of Biological Media

Krzysztof J. OPIELIŃSKI, Tadeusz GUDRA, Piotr PRUCHNICKI

Wrocław University of Technology

Institute of Telecommunications, Teleinformatics and Acoustics

Wybrzeże Wyspiańskiego 27, 50-370 Wrocław, Poland

e-mail: krzysztof.opielinski@pwr.wroc.pl

(received June 26, 2009; accepted January 15, 2010)

The following work presents the idea of constructing a digitally controlled active piezoceramic transducer matrix for ultrasonic projection imaging of biological media in a similar way as in case of roentgenography (RTG). Multielement ultrasonic probes in the form of flat matrices of elementary piezoceramic transducers require attaching a large number of electrodes in order to activate the individual transducers. This paper presents the idea of minimising the number of transducer connections in an active row-column matrix system. This idea was verified by designing a model of a matrix consisting of 16 ultrasonic transducers with electrode attachments optimised by means of electronic switches in rows and columns and miniature transistor switches in the nodes of the matrix allowing to activate selected transducers. The results of measurements and simulations of parameters of the designed matrix show that it is suitable to be used in projection imaging of biological media as a sending probe. In to use the matrix as a universal sending or receiving probe, it was suggested to add further switches that would eliminate the undesired effect of crosstalks in case of switches used for toggling the transducers in the nodes of the matrix.

Keywords: ultrasonic projection; active ultrasonic transducer matrix; multielement ultrasonic probe; electrode attachment optimisation.

1. Introduction

Ultrasonic imaging techniques are important parts of medical diagnostics. In most cases, however, specialists use echographic methods, such as ultrasonography or ultrasonic microscopy (TROTS *et al.*, 2008; PIOTRZKOWSKA *et al.*, 2009; DYNOWSKI *et al.*, 2008). Such measurements produce images that show reflection coefficient changes inside the studied structure. The transmission method, on the

other hand, uses information from ultrasonic pulses propagating through an object in order to produce images showing a projection of the studied structure (GREEN *et al.*, 1974) in the form of a distribution of average values of the measured acoustic parameter for one or more surfaces perpendicular to the direction of incidence of ultrasonic waves (similarly to roentgenography). The transmission method ensures a greater amplitude of ultrasonic receiving pulses in comparison to the echo method. This is a clear advantage. It is additionally possible to image simultaneously a few acoustic parameters, which are digitally determined on the basis of information obtained directly from ultrasonic pulses propagating through a structure (e.g. amplitude, transit time, mid frequency shift). This allows for a simultaneous generation of a few different projection images, each of which represents a different feature of the structure. Such a complex characteristics can be of significant importance in e.g. the process of diagnosing cancerous changes in tissue. The use of specially designed multielement ultrasonic projection probes with a fast electronic elementary transducer switching allows for acquiring images in pseudo-real time (e.g. with minor constant delay for data buffering and processing). A device using this method can be called ultrasonic transmission camera (UTC) (ERMERT *et al.*, 2000). There are a few research centres around the world, which are known to be working on such cameras (BRETTEL *et al.*, 1981; ERMERT *et al.*, 2000; GRANZ, OPPELT, 1987; GREEN *et al.*, 1974; OPIELIŃSKI, GUDRA, 2005).

The device described in the study (ERMERT *et al.*, 2000) utilizes a linear sending probe made of 128 rectangular piezoceramic transducers (of width much greater than their height), a linear receiving probe made of 128 PVDF film transducers (of height much greater than their width) and a lens focusing ultrasonic wave beam in one direction. The probes operate within the frequency range 2–4 MHz. The scanning of the structure of an object submerged in water between the probes is realised by means of phase focusing of the ultrasonic wave beam in the object's plane in the form of 1.25 mm wide horizontal lines, which after transition through the object and the lens are received by appropriate linear transducers of the receiving probe. There is a disadvantage however. Focusing the beam on a particular area of the object results in a fuzzy image and artefacts outside the focus.

The device described in the work (GREEN *et al.*, 1974) utilizes incoherent ultrasonic waves and a univariate linear matrix mounted in a fixed position used as receiver. Scanning of the object's structure in the second dimension was done by means of a complex system of properly rotated prisms. The disadvantage is that it is necessary to use mechanical elements.

The device described in the study (BRETTEL *et al.*, 1981) is based on an idea similar to that used in the study (GREEN *et al.*, 1974). There is the only difference that the image is projected onto a water surface of a camera and then detected by a linear transducer matrix. Moreover, the scanning in the second dimension is realised thanks to a mechanical movement of the matrix rather than to a system

of rotating prisms. Thus, the disadvantage is that it is necessary to use mechanical elements.

The device described in the study (GRANZ, OPPELT, 1987) operates in real time and its construction is similar to the camera presented in the study (BRETTEL *et al.*, 1981). A beam of incoherent ultrasonic waves, which propagates through an object is wide, which reduces the occurrence of spots. The image is obtained using a spherical mirror placed behind the object and in front of a 2D electronically controlled receiving transducer matrix made of a PVDF film and arranged into a 128×128 element configuration. The camera allows for acquiring images in pseudo-real time (with data buffering). It is possible to get 25 frames per second. Significant manufacturing costs and the level difficulty associated with achieving a faultless matrix are the disadvantages of this solution.

The signal amplitude is the projection parameter in case of most of the known UTC models. However, it seems that the signal transition time is a more interesting parameter because its measurement is easy to perform and more precise. In the work (OPIELIŃSKI, GUDRA, 2005), the authors described a computer assisted measurement system developed in order to study biological structures using the ultrasonic projection method. Scanning of objects submerged in water was realised using two ultrasonic probes, which are 5 mm in diameter, operate at 5 MHz frequency and function as a transmitter and receiver of ultrasonic waves. The probes were positioned along an axis opposite to one another and were moved meanderingly with a specified step and in a determined projection plane. The probes' movement was controlled using XYZ shift arms by a computer software via an RS232 bus. The sending probe was powered by a burst type sinusoidal signal. The pulses received by the other probe were sent using a digital oscilloscope and a RS232 bus to a computer and saved on a HDD. Special software was used to visualise three different acoustic parameters in the projection: the average values of the ultrasonic wave propagation, average values of the ultrasonic wave amplitude, average values of the shift of the mid frequency of the ultrasonic wave in a contour form with rainbow colours or greyscale and in a pseudo-3D form. The study (OPIELIŃSKI, GUDRA, 2005) presents projection images of the distribution of the above mentioned acoustic parameters in the structure of a hard boiled chicken egg with removed shell for longisection with resolution of 1.5×1.5 mm. On the basis of the achieved results it was concluded that although the projection imaging is not an exactly quantitative imaging, it is possible to determine the variations in the parameters of the studied structure on the basis of the individual pixel values. The computer assisted ultrasonic projection enabled a correct identification of heterogeneous areas in the structure of the egg. One of the advantages of this method is the possibility to achieve several different images, each of which presents slightly different features of the object's structure by the use of a single measurement set (OPIELIŃSKI, GUDRA, 2005). These images can be properly processed and correlated using special software, which allows the identification of structures that are invisible on separate

images. The image of the projection of the velocity distribution clearly shows continuous changes of heterogeneity, while the image of the projection of the mid frequency shift distribution shows step changes more distinctly. The image of the projection of the amplitude distribution is characterised by high dynamics of the value changes and shows continuous changes as clearly as the step ones. Additionally, projection measurements of the studied structure from various angles allow a tomographic quantitative 3D reconstruction of continuous changes and heterogeneity borders inside that structure.

The purpose of this study is among other things to develop a special equipment for visualization of biological structures by means of ultrasonic projection, which allows simultaneous measurements of several acoustic parameters in pseudo-real time (multiparameter ultrasonic transmission camera) using a pair of electronically controlled multielement matrices of elementary piezoceramic transducers without the necessity to focus the beam (Fig. 1).

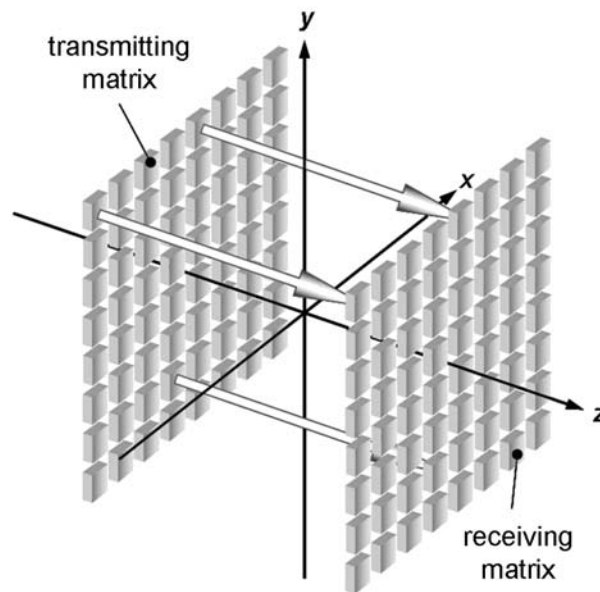

Fig. 1. The idea of ultrasonic projection in orthogonal projection.

As part of earlier work on transducer matrices (OPIELIŃSKI, GUDRA, 2009), models of 512-element sending and receiving ultrasonic probes were designed and produced to be used for visualisation of structure of biological media by means of ultrasonic projection (OPIELIŃSKI, GUDRA, 2005; 2009). The models were standard matrices of 512 elementary piezoceramic transducers in a 32×16 configuration, which are 1.5×1.5 mm in dimension (Fig. 2). Due to a large number of projection probe transducers and the necessity to simplify the technology involved in building further copies of the equipment, this work presents the idea of

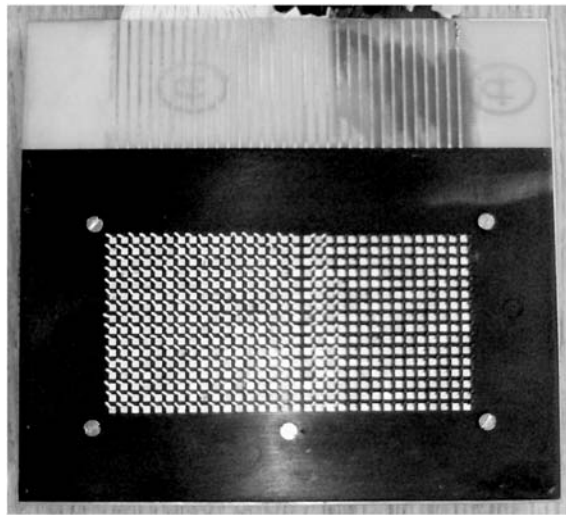

Fig. 2. View of the designed 512-element standard ultrasonic transducer matrix (OPIELIŃSKI, GUDRA, 2009).

minimising the number of connections of individual transducers in a row-column matrix system. This idea was verified by designing and measuring the parameters of a model of an active matrix consisting of 16 elementary ultrasonic transducers, with electrode attachments optimised by means of electronic switches in rows and columns and miniature transistor switches (in the nodes of the matrix) allowing for selective activation of the transducers. Calculation results of an acoustic field generated by the constructed probe were compared with the results of real measurements.

2. Elementary transducers

A model of a 16-element matrix was built using Pz37 Ferroperm piezoceramic plates which are of dimension 1.6×1.6 mm and 0.9 mm thick (Fig. 3).

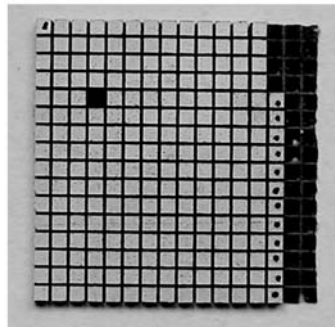

Fig. 3. View of Pz37 Ferroperm piezoceramic plates.

Amplitude-phase characteristics of elementary piezoceramic transducers measured in air using an accurate Wayne Kerr Electronics 65120B impedance analyser within the range of 0.8–2.4 MHz give 4 resonances at frequencies $f_1 \approx 1$ MHz, $f_2 \approx 1.6$ MHz, $f_3 \approx 1.8$ MHz and $f_4 \approx 2$ MHz (Fig. 4).

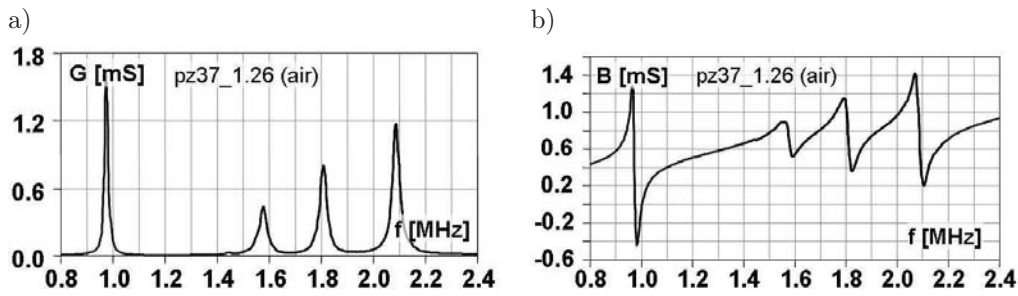

Fig. 4. Examples of the results of measurements of parameters of elementary a piezoceramic plate Pz37 no. 1.26 (size $1.6 \times 1.6 \times 0.9$ mm) performed in air: a) conductance, b) susceptance.

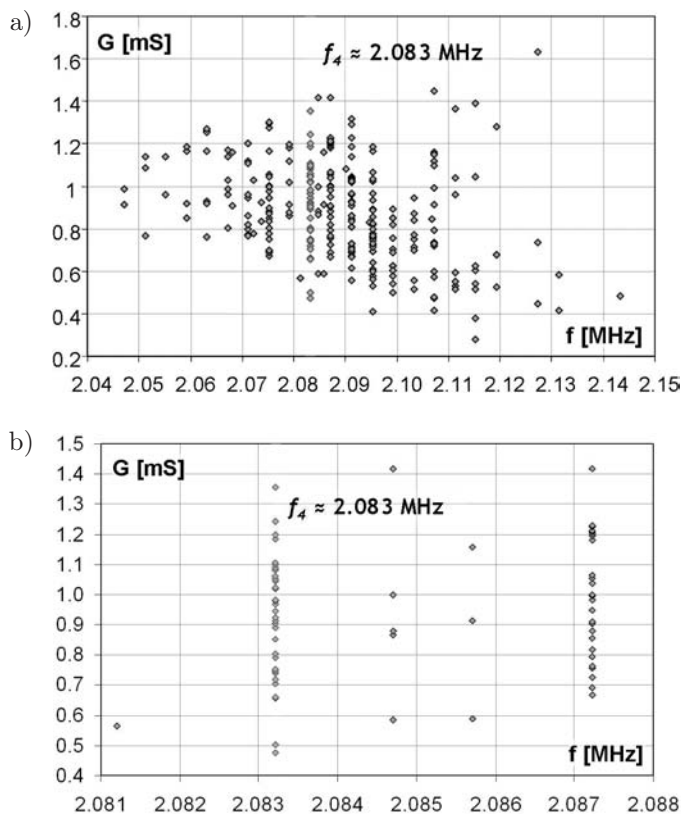

Fig. 5. Dispersion of values of the measured conductance G from the resonant frequency f_r : a) for all 280 elementary transducers, b) for elementary transducers with resonant frequencies in the range of $f_r = 2.081$ – 2.088 MHz.

It can be supposed, on the basis of the calculations performed, that the frequency f_1 corresponds to a resonance resulting from the length and width of the piezoceramic plate and the frequency f_4 corresponds to a resonance resulting from the thickness of the plate. It was assumed that the 16-element probe model would operate at the frequency of about 2 MHz. Amplitude-phase characteristics of 16 transducers selected from a group of 280 on the basis of repeatability of the selected $f_4 = 2.083$ MHz resonance frequency and the $G(f_4)$ conductance value (Fig. 5) show no f_4 value dispersion at the frequency measurement resolution of 4.01 kHz (Fig. 5b) and dispersion of $\Delta G(f_4) \approx 400 \mu\text{S}$ and $\Delta B(f_4) \approx 370 \mu\text{S}$ with a measurement uncertainty of 0.05% (Fig. 6).

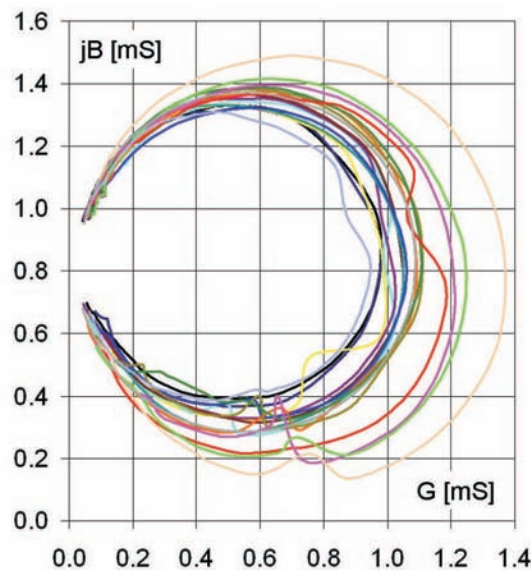

Fig. 6. Amplitude-phase characteristics of 16 selected elementary transducers in the 2.00–2.16 MHz frequency range.

3. The method of activating elements of the matrix

A large number of elementary transducers of the matrix necessitates making a lot of electric connections and significantly impedes the miniaturization. Using a row-column selection of active transducers (passive matrix) can solve the problem to some extent. A 512-element matrix arranged into 16 rows and 32 columns requires in this way only 48 (16+32) cables instead of 512. Using active elements (switches) in the nodes of the matrix additionally (active matrix) can help to eliminate the crosstalk between transducers in a passive matrix (OPIELIŃSKI *et al.*, 2009). In this solution each transducer has its own, individual switch that turns it on (Fig. 7).

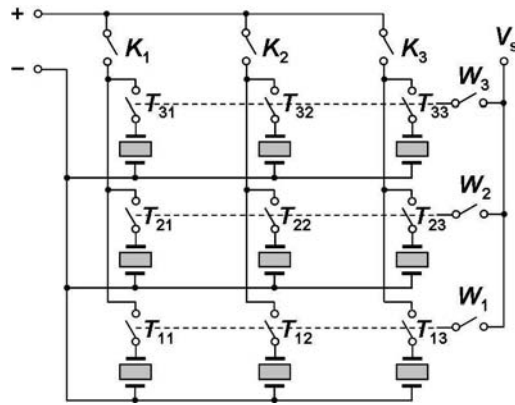

Fig. 7. Diagram of transducer connections in an active matrix.

Switch K_y in the signal path supplies voltage to a specific column, while the closing W_x switches determine which row is activated (MAX335 integrated circuits). BSS138 insulated gate field-effect transistors (MOSFET) with N type channel were used as individual T_{xy} switches. Their small package (SOT-23) is an advantage, as it allows for miniaturization of the connections. A 4094 8-bit serial in the parallel out shift register was used for controlling the active matrix switching.

4. Matrix design

In order to construct a model of an active ultrasonic matrix a suitable PCB (printed circuit board) was designed and produced. It was utilized as an elementary transducer pad in a 4×4 array (Fig. 8). The transducers were mounted using a designed and produced engraving laminate mesh with laser cut openings for piezoelectric plates (openings of 1.6×1.6 mm, distance between the openings – 0.9 mm). The piezoceramic transducers in the mounting mesh were attached

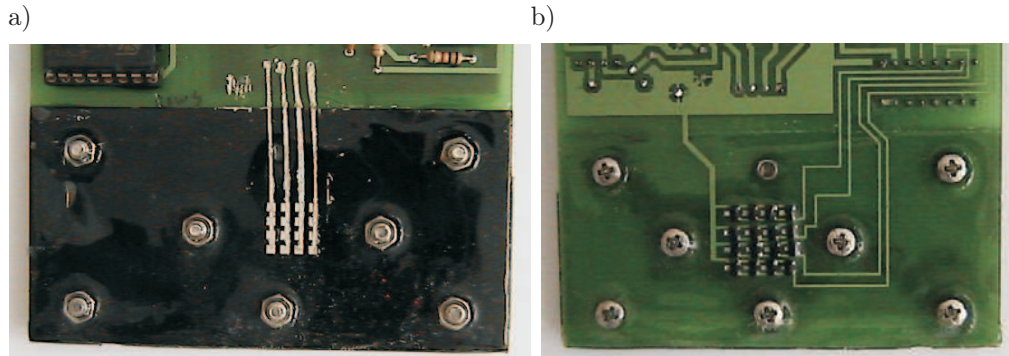

Fig. 8. View of the designed model of a 16-element active ultrasonic matrix: a) front, b) back.

to PCB traces (rows) using a small amount of conductive glue. Additionally, the mounting mesh was screwed to the PCB using bolts (Fig. 8).

The column traces were connected using a silver conductive adhesive with suitable hardener (Fig. 8a). The areas of the probes that were to be submerged in water were sprayed to achieve a transparent acrylic coating characterised by good insulation properties, which additionally functions as a layer matching the impedance of the ultrasonic transducers to the impedance of water. These areas were later given an additional transparent silicon rubber coating.

5. Measurements and calculations

Figure 9 shows $G(f)$ and $B(f)$ relations and Fig. 10 shows amplitude-phase characteristics ($G + jB$) for all elementary transducers of the designed model of an active matrix submerged in water, which were measured on the receiving side using a HP 3589A network analyser after every transducer had been activated with a suitable electronic switch (Fig. 7).

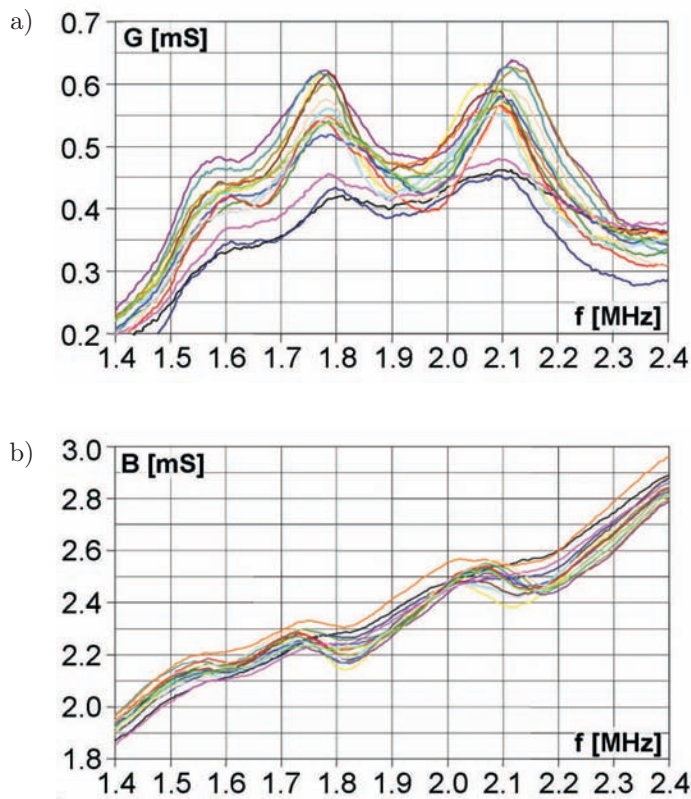

Fig. 9. Conductance $G(f)$ (a) and susceptance $B(f)$ (b) for 16 elementary transducers of the developed model of an active matrix.

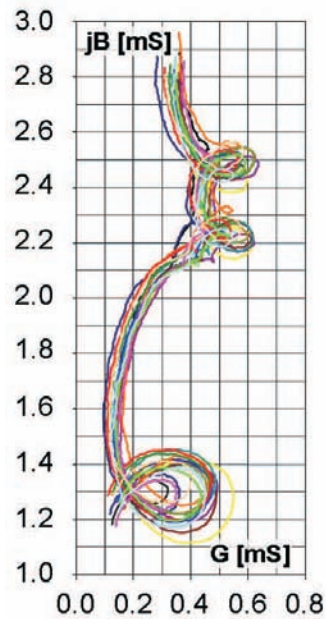

Fig. 10. Amplitude-phase characteristics of 16 elementary piezoceramic transducers of the developed model of an active matrix in the frequency range 0.8–2.4 MHz.

The $B(f)$ characteristics of elementary transducers of an active probe (Figs. 9b, 10) shows their capacitive nature. This suggests that there are crosstalks in the matrix. It can be suspected that the crosstalks are a result of using BSS138 transistors as electronic switches, and are more specifically associated with the capacitance of the transistors which is about 10 pF and is close to the capacitance of elementary transducers (OPIELIŃSKI, GUDRA, 2009). The MAX335 circuits, used as switches for rows and columns of the matrix, separate the signals activating the transducers correctly because they are characterised by a small capacitance of about 2 pF (their size, however, is significant). Calculations and measurements of voltages of the active matrix show that after the electrodes are connected to the proper row and column of the matrix and the right transistor switch is activated for a given transducer (Fig. 7), the transducer will be activated by the supplied voltage U , while the other transducers in this column will be activated by a voltage of about $0.3 \cdot U$ (Fig. 11).

Hydroacoustic measurements of the constructed transducer matrix were performed using a measurement set-up presented in Fig. 12.

The studied matrix was immobilised in a tank with degassed water using a special stand. A HPM05/2 Precision Acoustics hydrophone (diameter: 0.5 mm and sensitivity: 250 nV/Pa) was mounted on XYZ shift arms. In order to enable the control over the electronic switches activating the elements of the matrix by means of an RS232 serial port, the team used a specially designed electronic

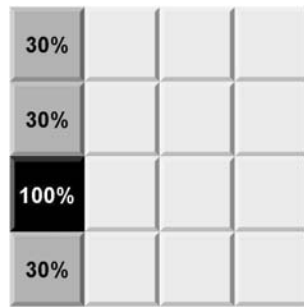

Fig. 11. Image of crosstalk in the model of an active matrix after activation of a transducer in the first column from the left and second row looking from the bottom.

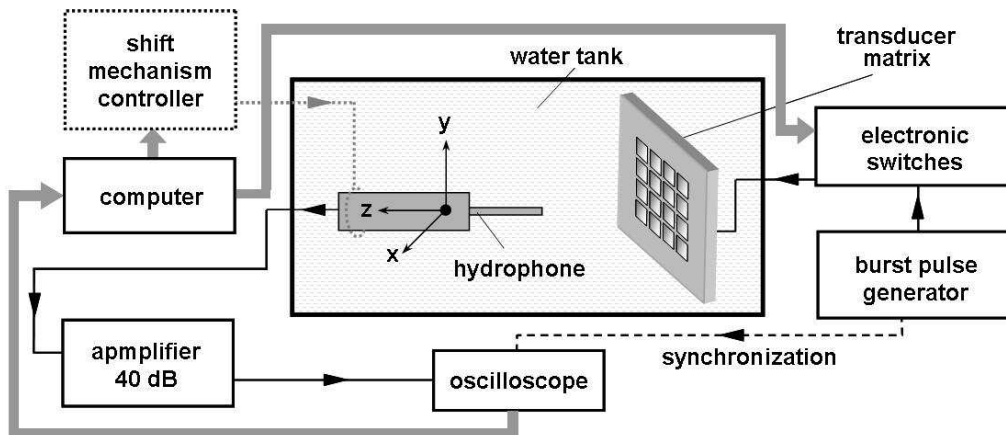

Fig. 12. A block diagram of the set-up for automatic measurement of the 3D acoustic field distribution.

system and computer software allowing to set the parameters of a pulse generator by means of a GPIB interface too. This control was realised using a separate computer. The transducers of the matrix were activated with burst type pulses with a repetition frequency of $f_p = 100$ Hz, filled with a sinusoidal signal of frequency $f = 2.08$ MHz and the length of 10 cycles. The pulse amplitude was 20 Vpp. The acoustic field generated by the elementary transducers was measured in water on a plane that was parallel to the surface of the matrix (perpendicular to the direction of propagation) at the distance of 50 mm from its surface, in the area of 40×40 mm (geometrical area centre in the hydrophone axis). The hydrophone was situated in relation to the surface of the matrix as shown in Fig. 13. Then activating electronically the individual transducers of the matrix (3.0, 3.1, 2.0, 1.1, 0.0, 0.1) the team measured their acoustic field (Fig. 14) moving the hydrophone in the area of 40×40 mm with a 1 mm step. The maximum measured value of the acoustic pressure while activating the individual transducers of the matrix (distance of 50 mm) was about $p_o^+ \approx 10$ kPa.

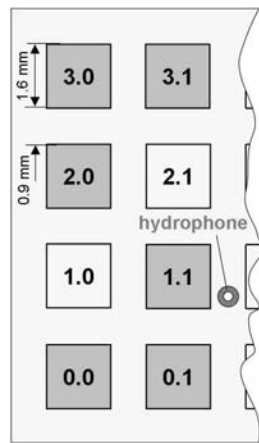

Fig. 13. Marked position of the hydrophone in relation to the surface of the matrix; marked elements of interest of the matrix.

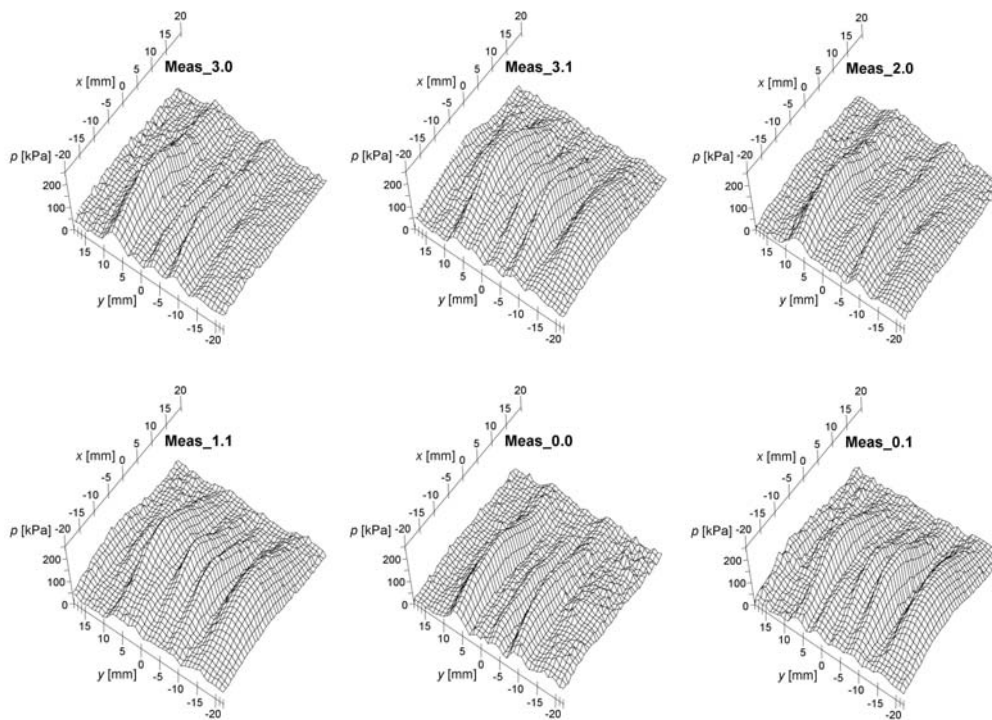

Fig. 14. Measurement results of the acoustic field distribution for elementary transducers of a model of an active matrix at the distance of 50 mm from its surface.

Figure 15 shows the results of the simulation of the acoustic field distribution achieved using a suitable numerical summing of the fields of individual elementary transducers (GUDRA, OPIELIŃSKI, 2006; OPIELIŃSKI, GUDRA, 2006).

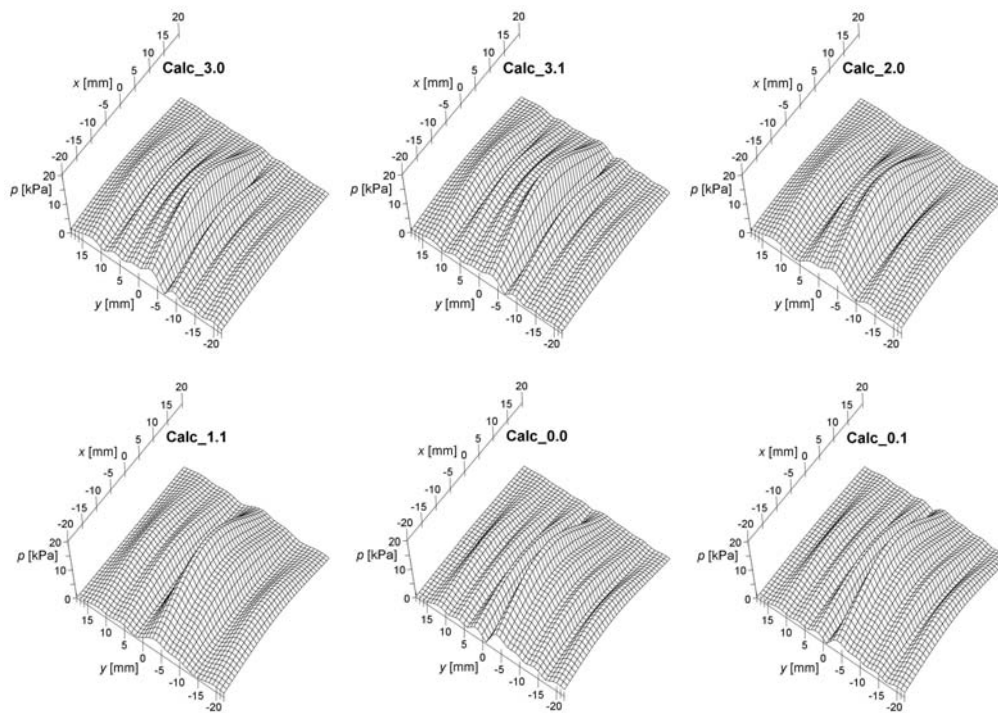

Fig. 15. Calculation results of the acoustic field distribution for elementary transducers of a model of an active matrix at the distance of 50 mm from its surface.

Measurements and calculations of the acoustic field distribution for elementary transducers of the developed model of an active matrix show consistence and confirm the phenomenon of crosstalk in the matrix columns (Figs. 14, 15). After activation of a single transducer of the model of the matrix, the divergence of the generated beam in horizontal plane is high. It is similar as in case of activation of an elementary transducer of a standard matrix (with no crosstalk) (OPIELIŃSKI, GUDRA, 2009). This proves a correct separation of the signals activating the transducers, which is supplied via electronic switches in the form of MAX335 integrated circuits. If an elementary transducer of the matrix in a given column is activated, the transducers in all the other columns remain inactive. Local maxima of the acoustic pressure amplitude in the vertical plane (Figs. 14, 15) prove that there is crosstalk in columns, the source of which can be found in miniature the transistor switches used in the nodes of the matrix. The differences in the location and values of these maximums in measurements and calculations of the acoustic field distribution result from diversified parameters of individual elementary transducers after they have been placed on the matrix. This in turn is a result of various sizes of the transducers, various surfaces and thickness of the bonded layers and a finite precision of locating the transducers in the matrix in all three dimensions.

As a result of crosstalk in columns occurring when activating a single transducer of the matrix, vertical side lobes are present in the acoustic field distribution (Fig. 16).

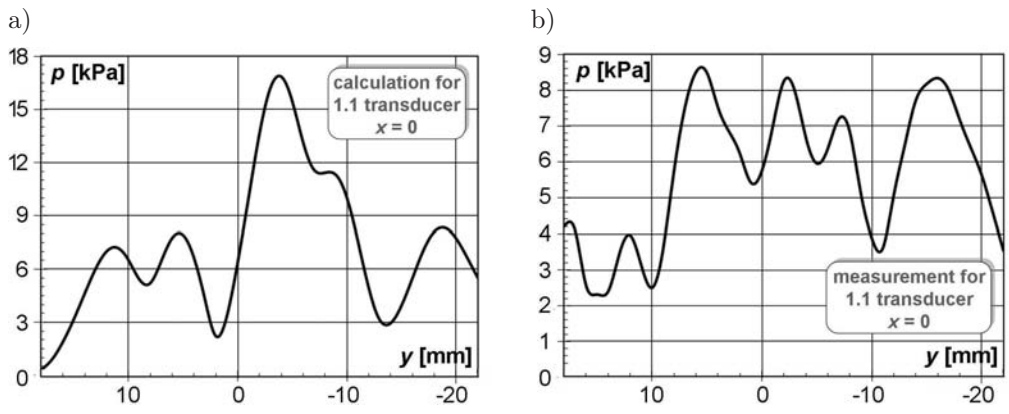

Fig. 16. Values of acoustic field distribution for the developed model of an active matrix with activated transducer 1.1, along the Y axis (vertical) at the distance of 50 mm from the matrix surface for $x = 0$: a) calculated, b) measured and transformed to acoustic pressure values according to hydrophone sensitivity.

Despite the visible horizontal and vertical shifts of the maximum of the acoustic pressure when switching the transducers of the matrix (Figs. 14, 15), the vertical side lobes can be the reason for projection imaging errors when using this type of probe as a detector. In order to eliminate crosstalk in columns of the active matrix, the team developed a system with an additional miniature electronic switch, the purpose of which is to short-circuit inactive transducers in the columns (Fig. 17).

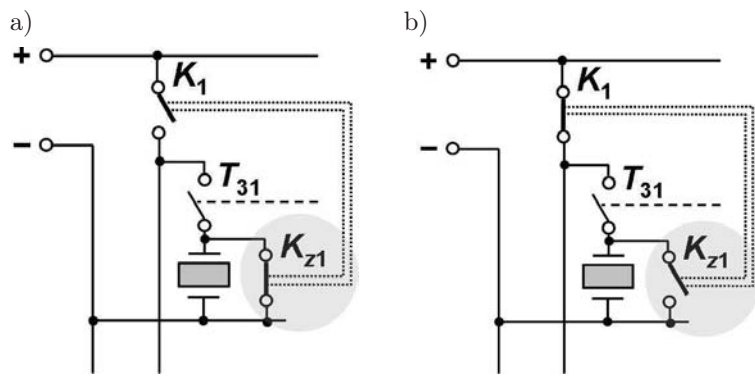

Fig. 17. The method of eliminating crosstalk in a column of the active matrix using additional switches K_{xy} : a) short-circuiting an inactive transducer, b) open-circuiting when activating a transducer.

6. Conclusions

Measurements and simulation of acoustic field distributions of the transducers of the designed model of an active matrix show that the electronic individual switches used allow for passing of the activating signal in the matrix columns – after activation of any element of the matrix all transducers in a given column are also activated (Figs. 14, 15). The measured acoustic field distributions are in accordance with theoretical calculations for linear sources consisting of numerous vibrating elements (OLSON, 1957) (side lobes creating). The switches for activating individual rows and columns separate the distribution of the activating signals in a correct manner – switching a transducer in a row results in a suitable shift of the maximum acoustic pressure amplitude (Figs. 14, 15). A slight asymmetry of the acoustic pressure amplitude maximums (Fig. 14) follows from the unparallel attachment of the elementary transducers. The differences in the values of these maximums are caused predominantly by the diversified effectiveness of the individual elementary transducers, as well as by an error associated with the possible lack of parallelism in the relative position of the hydrophone and the surface of the matrix. The results of measurements of parameters of the designed active matrix show that it can be used in projection imaging of biological media as a receiving probe. The crosstalk in columns can be eliminated using additional miniature switches to short-circuit inactive transducers in the columns. This allows to use the active matrix also as a multielement receiving probe.

Acknowledgment

This research was carried out as part of grant no. N N515 410634 funded by MNiSW (Ministry of Science and Higher Education of Poland) in the years 2008–2011.

This article is an extended version of the paper presented at the 56th Open Seminar on Acoustics – OSA2009, September 15–18 in Goniądz.

References

1. BRETTEL H., ROEDER U., SCHERG C. (1981), *Ultrasonic transmission camera for medical diagnosis*, Biomedizinische Technik, 26, 63.
2. DYNOWSKI K., LITNIEWSKI J., NOWICKI A. (2008), *Scanning Acoustic Microscope for 3D imaging*, Archives of Acoustics, 33, 3, 293–302.
3. ERMERT H., KEITMANN O., OPPELT R., GRANZ B., PESAVENTO A., VESTER M., TILLIG B., SANDER V. (2000), *A New Concept For A Real-Time Ultrasound Transmission Camera*, IEEE Ultrasonics Symposium Proceedings, San Juan, Puerto Rico.

4. GRANZ B., OPPELT R. (1987), *A Two Dimensional PVDF Transducer Matrix as a Receiver in an Ultrasonic Transmission Camera*, Acoustical Imaging, 15, Plenum Press, New York, 213–225.
5. GREEN P.S., SCHAEFER L.F., JONES E.D., SUAREZ J.R. (1974), *A New High Performance Ultrasonic Camera*, Acoustical Holography, 5, Plenum Press, New York, 493–503.
6. GUDRA T., OPIELINSKI K. (2006), *The multi-element probes for ultrasound transmission tomography*, Journal de Physique IV, **137**, 79–86.
7. OLSON H.F. (1957), *Acoustical Engineering*, Canada, D. Van Nostrand Company, 30–55.
8. OPIELIŃSKI K.J., GUDRA T. (2004), *Biological Structure Imaging by Means of Ultrasonic Projection*, Structures – Waves – Human Health 13(2), Polish Acoustical Society Division Kraków, Kraków, Poland, 97–106.
9. OPIELINSKI K.J., GUDRA T. (2005), *Computer recognition of biological objects' internal structure using ultrasonic projection*, Computer recognition systems (Advances in Soft Computing), Berlin, Springer, 645–652.
10. OPIELIŃSKI K.J., GUDRA T. (2006), *Determining the acoustic field distribution of ultrasonic multi-element probes*, Archives of Acoustics, **31**, 4, 391–396.
11. OPIELINSKI K.J., GUDRA T. (2009), *Multielement ultrasonic probes for projection imaging* [in:] Proceedings of the International Congress on Ultrasonics, Santiago de Chile, January 11–17 2009, Physics Procedia (in print).
12. OPIELIŃSKI K.J., GUDRA T., PRUCHNICKI P. (2009), *The method of a medium internal structure imaging and the device for a medium internal structure imaging* [in Polish], patent application no. P389014 to the Patent Office of the Republic of Poland, Wrocław University of Technology.
13. PIOTRZKOWSKA H., LITNIEWSKI J., LEWANDOWSKI M., SZYMAŃSKA E., NOWICKI A. (2009), *Use of Quantitative Ultrasound to Measure Acoustic Properties of Human Skin*, Archives of Acoustics, **34**, 4, 471–480.
14. TROTS I., NOWICKI A., LEWANDOWSKI M. (2008), *Laboratory setup for synthetic aperture ultrasound imaging*, Archives of Acoustics, **33**, 4, 573–580.