

Application of malacological analysis in local and regional palaeoenvironmental reconstructions – a study from the Holocene of Łapsze Niżne (Podhale, southern Poland)

WITOLD PAWEŁ ALEXANDROWICZ¹, MARCIN SZYMANEK² and ELIZA RYBSKA³

¹ *AGH University of Science and Technology, Faculty of Geology, Geophysics and Environment Protection, Chair of General Geology and Geotourism, Al. Mickiewicza 30, 30-059 Cracow.*

E-mail: wpalex@geol.agh.edu.pl

² *University of Warsaw, Faculty of Geology, Al. Żwirki i Wigury 93, 02-089, Warsaw.*

E-mail: m.szymanek@uw.edu.pl

³ *Adam Mickiewicz University, Faculty of Biology, Laboratory for Teaching Biology and Natural Sciences, Umultowska 89, 61-614 Poznań. E-mail: elizary@amu.edu.pl*

ABSTRACT:

Alexandrowicz, W.P., Szymanek, M. and Rybska, E. 2018. Application of malacological analysis in local and regional palaeoenvironmental reconstructions – a study from the Holocene of Łapsze Niżne (Podhale, southern Poland). *Acta Geologica Polonica*, **68** (1), 89–105. Warszawa.

This malacological analysis was conducted at a site with peat and calcareous tufas in Łapsze Niżne, Podhale (southern Poland). The study was carried out in 6 main and several complementary sections, in which 37 mollusc species were recognized represented by almost 11 000 specimens. The study enabled the reconstruction of environmental changes during the accumulation of the Holocene deposits (from the Boreal Phase till present). Conclusions drawn from these reconstructions were compared with results of malacological and palynological studies from other sites in Podhale. As a result, regional environmental reconstructions for the Holocene of the area were made. The specific composition, ecological structure and succession of molluscan assemblages from Łapsze Niżne indicate a significant role for local factors, thus demonstrating the variability of environmental conditions within a geographic region.

Key words: Calcareous tufa; Peat; Molluscs; Environment; Holocene; Podhale; Southern Poland.

INTRODUCTION

Podhale is an intramontane area bounded to the south by the Tatra Massif and to the north by the Beskid Range. The area corresponds mostly to the Podhale Synclinorium, filled with Palaeogene flysch, folded during the Early Miocene. In the northern part of the area runs the belt of Mesozoic limestones of the Pieniny Klippen Belt. Quaternary deposits of the Podhale area are relatively thin. They

are represented by fluvial sediments and slope deposits. Limestone bedrock favours the formation of calcareous tufa occurring in numerous sites in the Podhale area. Calcareous tufa serves as indicators of fault zones in the basement rocks (Mastella 1975; Mastella and Rybak-Ostrowska 2012). It also favours the preservation of mollusc shells in a subfossilized state. Evidence for the presence of malacofauna has been found in numerous sites containing such deposits (Alexandrowicz 1997a, 2010; Alexandrowicz

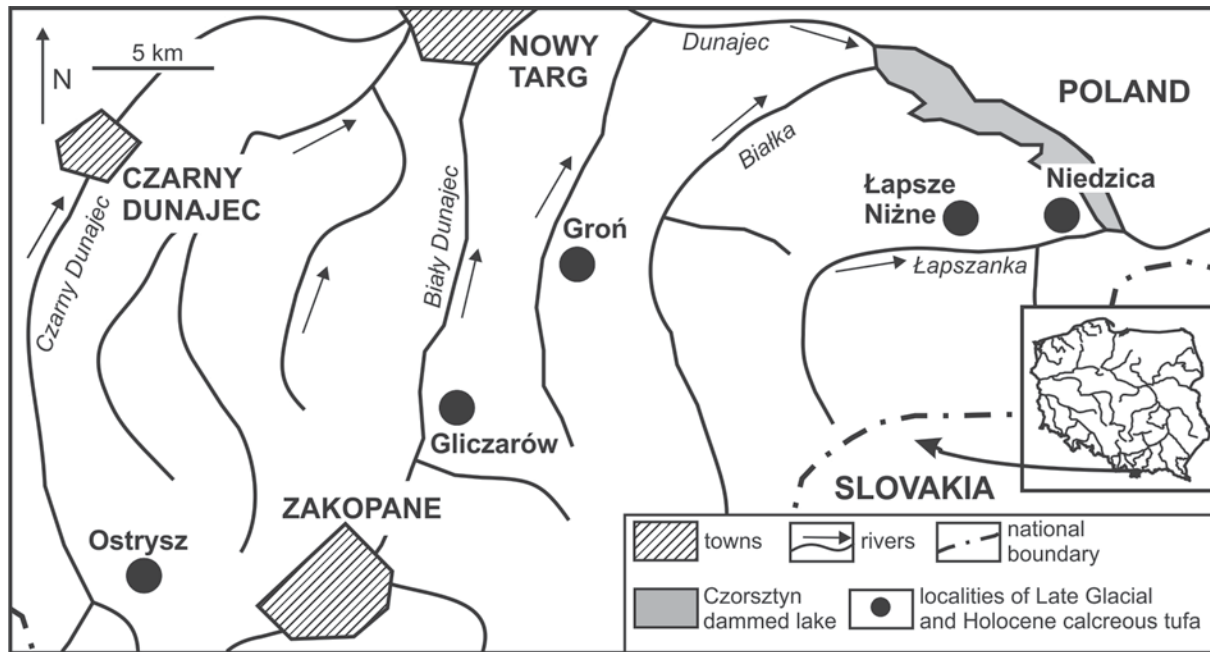

Text-fig. 1. Location of profiles of Late Glacial and Holocene calcreous tufa in Podhale Basin

et al. 2014). Most of the tufa precipitated recently or during the last few hundred years. Only a few sites (Gliczarów, Ostrysz, Groń and Niedzica – Text-fig. 1) contain older deposits representing the Late Glacial (Younger Dryas or even Alleröd) and the Holocene. The rich and diverse fauna occurring at these sites has been applied in palaeogeographic and palaeoenvironmental reconstructions (Alexandrowicz 1997a, 2001, 2003, 2004, 2010, 2013a; Alexandrowicz and Rybska 2013; Alexandrowicz *et al.* 2014). The malacological analyses have indicated similarities between particular sites. The observations point to the presence of regional climatic trends influencing the malacocoenosis development. However, preliminary studies carried out in Łapsze Niżne have pointed to its distinctness in comparison to other sites (Alexandrowicz, 1997a). Significant factors influencing this distinctness include local conditions such as the morphology, exposition of the slopes, humidity, character of the flora and many others influencing the specific character of the microhabitats in this site.

Malacological analyses of Quaternary deposits undertaken in numerous sites across Europe have been focused mainly on regional reconstructions (e.g. Mania 1995; Alexandrowicz and Alexandrowicz 1995 a, b; Prece 1998; Gedda 2001; Alexandrowicz 2004; Juříčková *et al.* 2014a; Limondin-Lozouet and Prece 2014; Horáčková *et al.* 2015). Minor interest

was placed on environmental changes within particular geographical regions. The cognitive aspect of such research is high, because it allows the evaluation of the influence of local factors, in many cases restricted to the sedimentation zone.

The changes in composition and structure of mollusc associations are always determined by two factors. The first concerns the regional environmental changes linked to climatic fluctuations and, more recently, to human activity. The second concerns the microenvironmental factors the effects of which are limited to the immediate surroundings of a location. This kind of analyses can be particularly successful when conducted in areas with a well-known history of environmental changes. The Podhale area is an excellent example of such area, where numerous malacological and palynological sections have been studied. The present work constitutes an example of the use of malacological studies for the reconstruction of the diversification of environments within a geographical region, available also for use in similar analyses in other areas.

The Łapsze Niżne site is located in the valley of the Łapszanka Stream between the towns of Niedzica and Łapsze Niżne (49°24'09"N, 20°15'48"E) (Text-fig. 1). Deposits yielding mollusc shells occur as a flat fan beneath the southern slope of the Barwinkowa Mt. close to a small spring. The fan is about 100 m

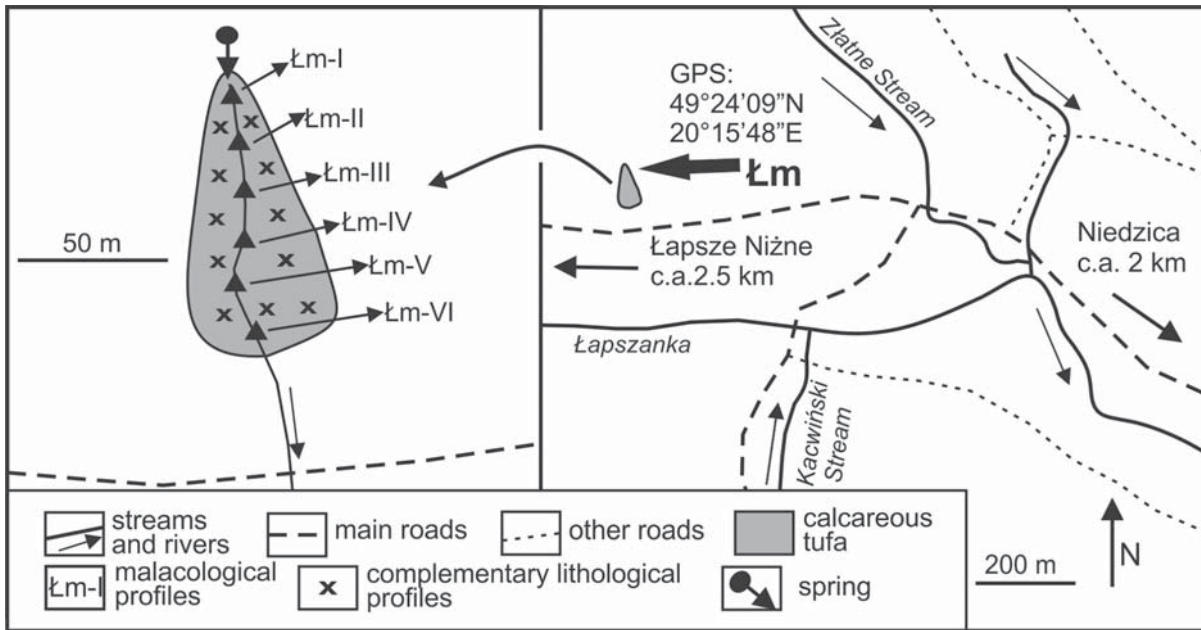

Text-fig. 2. Location of profiles of calcareous tufa and peat in Łapsze Niżne site

long and 50 m wide in its distal part (Text-fig. 2). It is composed of calcareous tufa and peat, underlain by slope deposits (in its proximal part) and by fluvial sediments of the channel and over-bank facies building the higher terrace of Łapszanka (in its distal part). The fan deposits were recognized in several shallow diggings which expose their internal structure (Text-fig. 2). The analyses of the sites allowed for the characterization of each deposit as well as for the correlation of particular profiles. The basal part of the sequence is built of black, well-decomposed peat with a few sharp-edged, small blocks of sandstone as well as clumps of white calcareous tufa whose contribution increases upwards. The thickness of the basal peat layer is relatively uniform and averages 10 cm. These deposits occur only in the central part of the fan (Text-fig. 3). The peat is covered with white, medium- and fine-grained calcareous tufa with plant remains at the base. This bed does not occur in the proximal part of the fan and its thickness reaches a maximum of 45 cm (Text-fig. 3). The tufa is covered by a thin (2–5 cm) layer of fine-grained, grey sand. The transition is sharp and rugged. The upper part of the sequence comprises black and brown peat up to 50 cm thick. This contains a continuous interbedding up to 5 cm thick of fine- and medium-grained sand containing sharp-edged small blocks of sandstone (Text-fig. 3). In the proximal part of the fan, the peat is overlain by a third sandy interbed covered by

silty calcareous tufa up to 20 cm thick (Text-fig. 3). The CaCO_3 content in the calcareous tufas ranges from 80% to 90%. In peat it is distinctly lower and does not exceed 20%. The marked content of carbonates in peat layers is associated with the action of calcium carbonate-rich water. This phenomenon is commonly observed in central and northern Poland (Dobrowolski *et al.* 2005, 2012; Ratajczak-Szczerba 2014), as well as in the Carpathians (Alexandrowicz 1997a, Horsák and Hájek 2003; Horsák *et al.* 2007).

MATERIAL AND METHODS

Malacological studies in Łapsze Niżne have been carried out for several years. A portion of the malacological material previously obtained was tentatively examined by one of us (WPA), and generalised results of the studies were included in a monograph on the Quaternary malacofauna of the Podhale area (Alexandrowicz 1997a). The latest studies comprised a detailed examination of the internal structure of the tufa cone through a series of shallow boreholes (Text-fig. 2). Additional samples for malacological analysis as well as samples for radiocarbon dating were obtained.

Twenty-five molluscs-bearing samples were collected from six profiles. Each sample weighed 2 to 3 kg and represented intervals with a thickness of

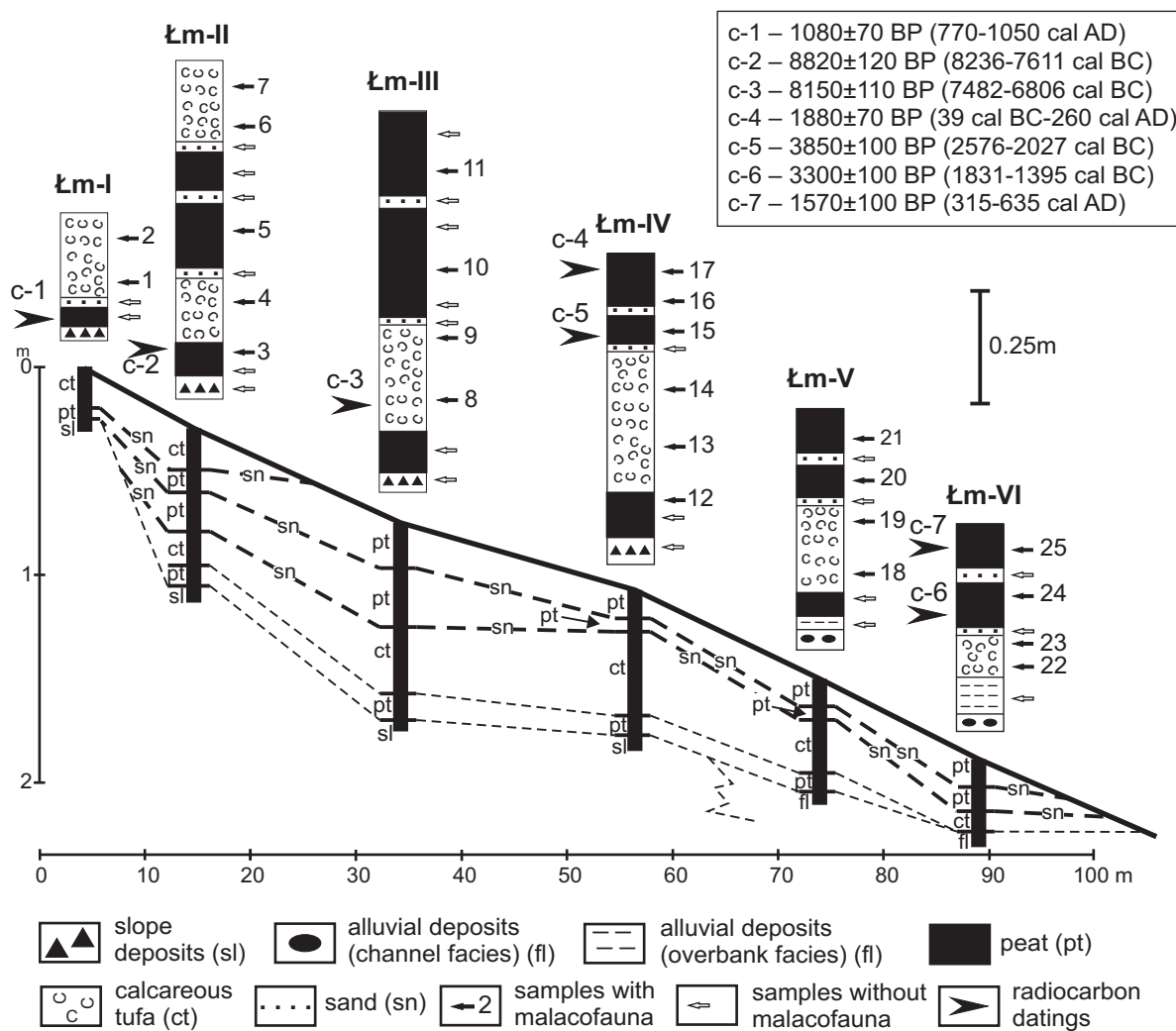

Text-fig. 3. Profiles, lithology and internal structure of Holocene deposits in Łapsze Niżne site

0.1–0.2 m. The number of samples collected from particular profiles varied from 2 to 6 and depended on the lithological composition and the thickness of the deposits. Additionally, 25 samples without remains of molluscs were collected. These samples represented sandy insertions, some peat insertions, as well as slope and fluvial deposits occurring at the base of profiles (Text-fig. 3).

After removing silt and drying, mollusc shells including determinable fragments were picked from the samples. The shell material was determined using taxonomic keys (e.g. Kerney *et al.* 1983; Wiktor 2004) and comparative collections. The frequency of particular species was determined in each sample. The malacological analysis was conducted using standard malacological methods (Ložek 1964;

Alexandrowicz and Alexandrowicz 2011). Particular taxa were assigned to the ecological groups: F – shade-loving, O – open-country, M – mesophilous, H – hygrophilous, and W – water. The percentage contribution of particular ecological groups was used to calculate the malacological spectrum (MSI) (Ložek 1964; Alexandrowicz and Alexandrowicz 2011). Statistical analysis including analysis of the dendrogram of similarity and correspondence analysis was conducted with the use of PAST software (Hammer *et al.* 2001). The dendrogram was constructed using the method described by Morisita (1959). The stratigraphic position of each assemblage was determined based on radiocarbon datings. The radiometric analyses were conducted in the Absolute Dating Methods Centre, Institute of Physics, Silesian University of

Technology in Gliwice (lab code Gd). The radiocarbon analyses were made on plant remains from peat (6 samples) and shells of *Perforatella bidentata* from calcareous tufas (one sample). Results of age determinations were calibrated based on the calibration curve (Stuiver *et al.* 1998), with application of OxCal V 3.9 software (Bronk Ramsey 2003). In the study, the scheme for division of the Holocene published by Mangerud *et al.* (1974) was applied.

The determination of the calcium carbonate content in the samples of calcareous tufas (4 samples) and peat (4 samples) were performed by Scheibler method (Bąk 1992).

Palaeoenvironmental reconstructions and age determinations were backed up with data and conclusions resulting from malacological studies carried out in other sites with Quaternary deposits in the Podhale area (Alexandrowicz 1997a, 2001, 2003, 2010, 2013a, b; Alexandrowicz and Rybska 2013; Alexandrowicz *et al.* 2014) and palynological studies of the Podhale peatlands (Obidowicz 1990; Chrynowiecka-Czmielewska 2009; Łajczak 2009).

RESULTS

Malacofauna

The studied shell material comprised 37 taxa and calcareous plates of slugs (*Limacidae*). A total of almost 11 000 specimens was examined. Additionally, the examined material contained a lot of unidentifiable shell fragments. The number of species in particular samples varied from 14 to 23, whereas the number of specimens ranged from 210 to 1285 (Table 1).

In comparison to the malacocoenoses described from other sites with similar sediments in the Podhale area (e.g. Alexandrowicz 1997a, Alexandrowicz *et al.* 2014), the malacofauna recognized in the profiles in Łapsze Niżne is characterized by relatively low species variability. Its main feature is the distinctly lower contribution of shade-loving species – only 11 taxa (Table 1). The lower part of the succession yields forms characteristic of rather cold climate: *Discus ruderatus* and *Perforatella bidentata*, accompanied by the relict species *Semilimax kotulae*. In the upper part of the profiles the only common shade-loving species is *Vitrea crystallina* (Text-fig. 4). Snails of open habitats are represented by 4 species, among which higher abundances are attained only by *Vallonia pulchella*. The contribution of this ecological group is the highest in the upper part of the pro-

files (Text-fig. 4). Mesophilous taxa are common in the basal peat and the lower tufa interbedding, where they the dominant group of gastropods. Characteristic is the abundant occurrence of the boreal species *Vertigo substriata*, accompanied by *Euconulus fulvus*, *Punctum pygmaeum* and *Perpolita hammonis* (Table 1). Worth pointing out is the presence of the cold-loving *Columella columella* which is a glacial relic. The upper part of the succession is characterized by the lower contribution of mesophilous forms expressed in the lower abundance of *Vertigo substriata*, *Euconulus fulvus* and *Punctum pygmaeum* and the disappearance of *Columella columella* (Text-fig. 4). Species favouring humid environments are numerous in the upper part of the upper peat layer. Besides the common *Vertigo antivertigo*, abundant are also *Succinea putris* and *Carychium minimum*. *Vertigo genesii*, a tundra, cold-loving form occurs in the lower part of the succession (Text-fig. 4). Water molluscs are present throughout the succession, but they are most abundant in the uppermost tufa exposed in the proximal part of the fan. This part of the succession is characterized by the presence of *Bythinella austriaca*. This stenotopic form typical of spring areas is the dominant element of the fauna (Text-fig. 4, Table 1).

Molluscan assemblages

The conducted taxonomic analysis based on the dendrogram of similarities and correspondence analysis (Text-figs 5, 6) allows to distinguish and define four faunal assemblages. Several assemblages show a distinct correspondence with the beds distinguished in the profiles based on lithological features.

Assemblage with *Vertigo substriata*: this is characterised by the occurrence of numerous shells of *Vertigo substriata* and other species with high ecological tolerance: *Perpolita hammonis*, *Punctum pygmaeum* and *Euconulus fulvus*. Common is *Discus ruderatus*, a taxon typical of taiga-type coniferous forests, and *Perforatella bidentata*, a hygrophilous, East-european snail typical of wet forests, especially alder woods. Shells of cold-loving forms are also present (*Semilimax kotulae*, *Vertigo genesii* and *Columella columella*). The *Vertigo substriata* assemblage indicates slightly shaded biotopes with significant humidity (Text-figs 5, 6). The abundant occurrence of *Vertigo substriata*, accompanied by cold-loving species as well as by *Discus ruderatus* and *Perforatella bidentata* indicate a cold climate with continental influence.

The fauna with *Vertigo substriata* in the Łapsze

E	TAXON	Łm - I		Łm-II				Łm-III				Łm-IV					Łm-V				Łm-VI							
		1	2	3	4	5	6	7	8	9	10	11	12	13	14	15	16	17	18	19	20	21	22	23	24	25		
F	<i>Platyla polita</i> (Hartmann, 1840)									12		1				4								5	3			
F	<i>Vertigo pusilla</i> Müller, 1774	1																						2	2			
F	<i>Macrogastera tumida</i> (Rossmässler, 1836)																							1	2			
F	<i>Discus ruderatus</i> (Hartmann, 1821)			25	34	6			29	21	3		31	24	18	3	3		32	24	3		39	7	2			
F	<i>Vitrea diaphana</i> (Studer, 1820)															1					2							
F	<i>Vitrea crystallina</i> (Müller, 1774)			3	7	86				5	129	2		5	9	103	15	1			114	17		97	102	14		
F	<i>Semilimax kotulæ</i> (Westerlund, 1883)			14	12	1			10	9			16	22	14				19	17			22					
F	<i>Fruticicola fruticum</i> (Müller, 1774)												1	2	1				2						2	2		
F	<i>Monachoides vicinus</i> (Rossmässler, 1842)					22							3							2	1	6	1		1	2		
F	<i>Perforatella bidentata</i> (Gmelin, 1791)			29	33	41	3		33	41	12		19	22	16	1	7	4	22	15	14	5	19	3	1	4		
O	<i>Vallonia costata</i> (Müller, 1774)	11	31	2	2	1	44	25		1	5	17	1					1			3	1	1			1		
O	<i>Vallonia pulchella</i> (Müller, 1774)	61	124	13	22	11	39	66	8	15	14	21	13	18	14	28	36	17	14	16	21	24	14	2	12	31		
O	<i>Pupilla muscorum</i> (Linnaeus, 1758)	61	40	1	1	18	22	31																				
O	<i>Vertigo pygmaea</i> (Draparnaud, 1801)	11	12				8	10																				
M	<i>Carychium tridentatum</i> (Risso, 1826)			2	3				4	16	7	2	6	1	7		11	7	7	1	3	8	4	1	5	1		
M	<i>Succinella oblonga</i> (Draparnaud, 1801)		8		2		12	14	5	4	1	3	3	2	1	9	2	9	5	1	1	2	6					
M	<i>Cochlicopa lubrica</i> (Müller, 1774)	53	47	16	31	4	1	5	12	40	9	14	18	32	31	28	35	12	13	10	16	22	12	10	4	10		
M	<i>Columella columella</i> (Martens, 1830)			10	5				15	8			22	11	9													
M	<i>Vertigo substriata</i> (Jeffreys, 1833)			89	93	7			96	122	6	1	99	144	96		1		175	146	12	1	122	14	1			
M	<i>Vertigo angustior</i> Jeffreys, 1830	33	52			17	29	33																				
M	<i>Punctum pygmaeum</i> (Draparnaud, 1801)	7	4	11	21	7	4	1	15	35	12	22	3	16	10	6	6	4	15	8	22	5	5	6	7	12		
M	<i>Euconulus fulvus</i> (Müller, 1774)	1	9	7	7	1	8	1	8	21	8	6	7	16	19	11	13	7	22	14	8	9	12	4	10	5		
M	<i>Perpolita hammonis</i> (Ström, 1765)	25	31	41	41	2	22	35	41	66	21	16	25	32	42	26	58	22	31	22	26	23	15	12	21	22		
M	<i>Perpolita petronella</i> (L. Pfeiffer, 1853)			4	6		1		9	21	3	2	9	8	15	6	16	5	10	9	4	7	1	3	8	4		
M	Limacidae	21	6	2	2	2	2		4	9	1		4	2	5	4	6	1	1		1	1	1		1			
M	<i>Vitrina pellucida</i> (Müller, 1774)	3	1																				1		1	3		
H	<i>Carychium minimum</i> Müller, 1774	50	85	48	41	2	47	55	38	60	22	33	18	36	31	7	17	3	19	21	25	27	22	21	26	30		
H	<i>Succinea putris</i> (Linnaeus, 1758)	253	164	1	1	77	21	12	3	3	1	36				14	34											
H	<i>Vertigo genesii</i> (Gredler, 1856)			21	10				21	18			19	10	13				14	9			11					
H	<i>Vertigo antivertigo</i> (Draparnaud, 1801)	96	44	1		32	44	17					16	143				21	94	124			33	149		16	25	99
H	<i>Zonitoides nitidus</i> (Müller, 1774)	1								3							1	9	17	1	5	6	13	1	5	2	2	

E	TAXON	Łm - I		Łm-II				Łm-III				Łm-IV					Łm-V				Łm-VI						
		1	2	3	4	5	6	7	8	9	10	11	12	13	14	15	16	17	18	19	20	21	22	23	24	25	
W	<i>Bythinella austriaca</i> (Frauenfeld, 1857)	499	544				323	298																			
W	<i>Galba truncatula</i> (Müller, 1774)	34	39			5	8		6		2	10	2	1		2		10	9	12	16	25	2	1	1		
W	<i>Pisidium casertanum</i> (Poli, 1791)					2			8			1								2	3	1					
W	<i>Pisidium personatum</i> Malm, 1855	39	44	3	1				6	20	3	7	4		16			12		3	14	7			1		
W	<i>Pisidium obtusale</i> (Lamarck, 1818)								3	3								1		1	1						
Total species		20	19	21	21	20	18	14	21	23	19	17	22	19	19	15	19	20	17	20	23	20	20	18	23	16	
Total specimens		1260	1285	343	375	344	638	603	374	553	275	326	324	404	367	256	348	293	409	338	349	353	311	210	240	242	
Shells fragments (indeterminate)		566	298	247	311	432	544	299	376	290	443	461	298	319	655	435	288	319	396	401	522	463	481	368	216	315	

Table 1. List of species recognized in profile of calcareous tufa and peat in Łapsze Niżne site. E. ecological groups of molluscs (after Ložek 1964; Alexandrowicz and Alexandrowicz 2011): F – shade-loving snails, O – open-country snails, M – mesophilous snails, H – hygrophilous snails, W – water snails; Łm-I – Łm-VI – profiles described in text

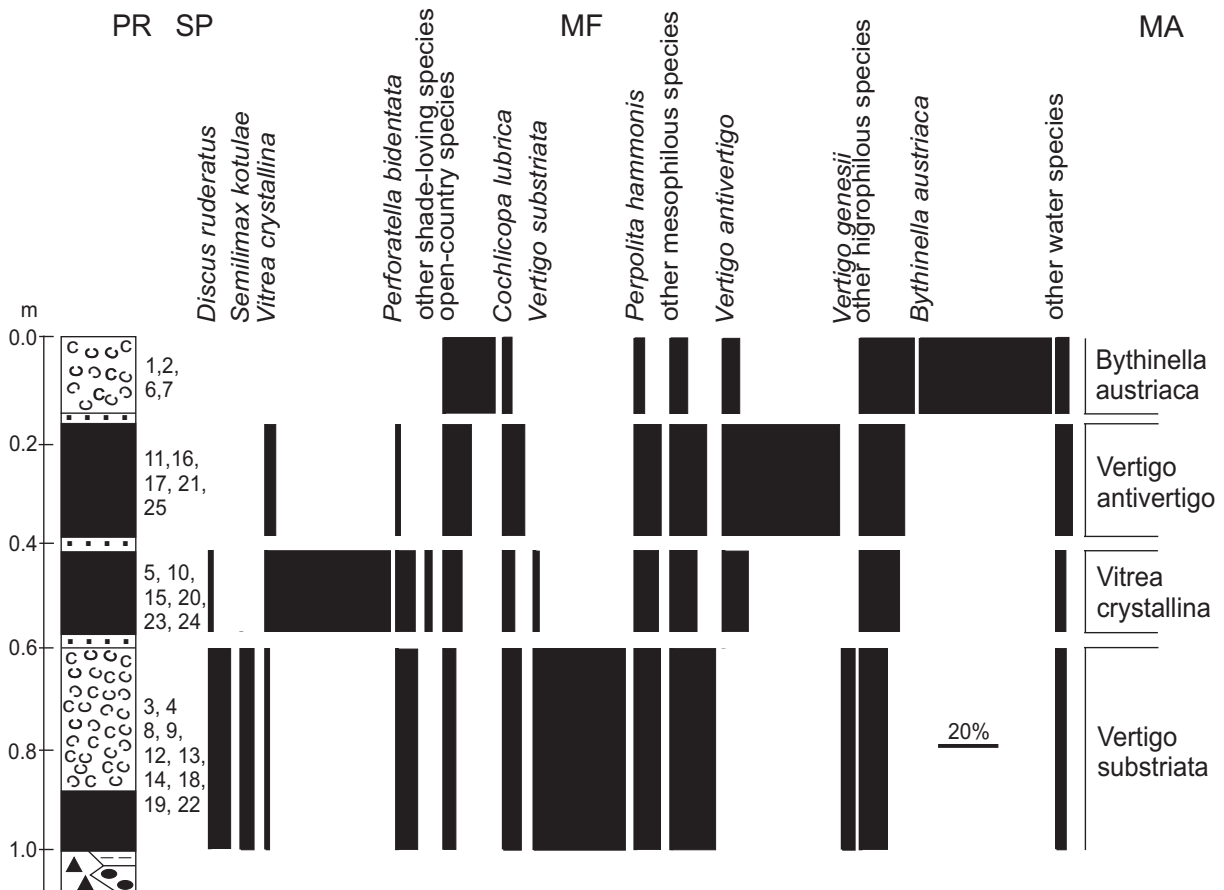

Text-fig. 4. Synthetic profile and ecological composition of malacofauna from calcareous tufa and peat in Łapsze Niżne site. PR – synthetic lithological profile (for explanation see Text-fig. 3), SP – samples, MF – malacofauna, MA – molluscan assemblages described in text

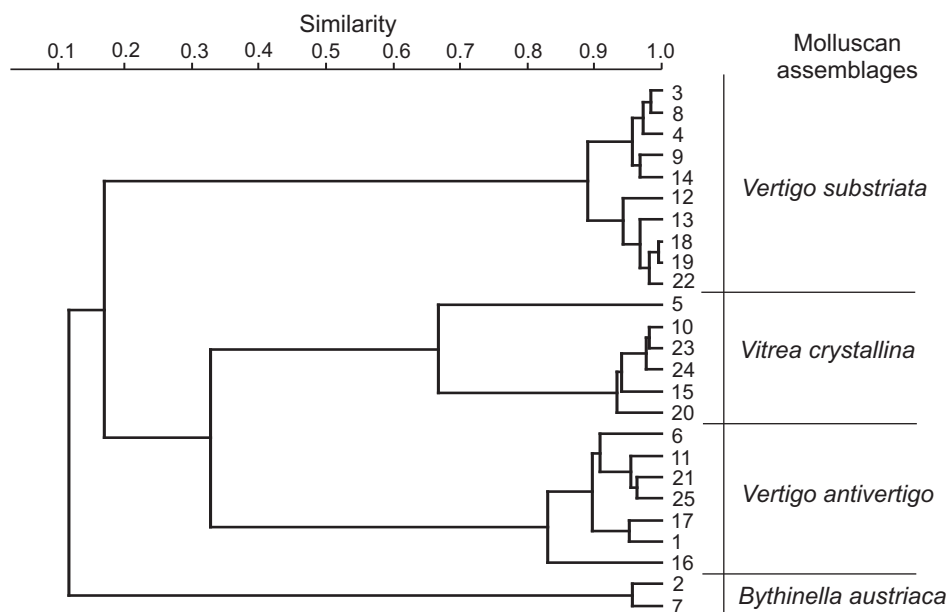

Text-fig. 5. Cluster analysis of malacofauna of the profile in Łapsze Nizne

Nizne corresponds to the Boreal Phase and the older part of the Atlantic Phase. Such a stratigraphic position is indicated by the age determination of the deposits containing this assemblage: 8236–7611 cal BC (profile Łm-II; c-2) and 7482–6806 cal BC (profile Łm-III; c-3) (Text-fig. 3, Table 2). The malacocoenosis was recognized in peat and calcareous tufas composing the lower parts of profiles Łm-II, Łm-III and Łm-VI (Text-figs 3, 4).

The assemblage with *Vitrea crystallina* is dominated by shade-loving species, typical of wet, sparse forests and bushes. Particularly abundant is *Vitrea crystallina*, which can make up to 30% of the assemblage (Text-fig. 4). The fauna is supplemented by mesophilous taxa (*Perpolita hammonis*, *Cochlicopa lubrica*), hygrophilous forms (*Carychium minimum*) and open-country snails (*Vallonia pulchella*). This assemblage represents shaded habitats with patches

of light forest trees or bushes and a damp substrate (Text-figs 5, 6). The fauna with *Vitrea crystallina* is characteristic of the Subboreal Phase: 2576–2027 cal BC (profile Łm-IV; c-5) and 1831–1395 cal BC (profile Łm-IV; c-6) (Text-fig. 3, Table 2). The malacocoenosis was recognized in all profiles except Łm-I and occurs in the basal part of the lower peat layer (Text-figs 3, 4).

The assemblage with *Vertigo antivertigo* is characterized by a significantly high abundance of hygrophilous forms preferring open habitats: *Vertigo antivertigo*, *Carychium minimum* and *Succinea putris*. Numerous are mesophilous gastropods: *Cochlicopa lubrica* and *Perpolita hammonis*, as well as an open-country form typical of dryer habitats – *Vallonia pulchella*. The fauna is accompanied by a species of temporary water bodies that can live also in very humid terrestrial biotopes (*Galba truncat-*

Date	Profile	Material	Age BP	Laboratory code	Calibrated age (BC/AD)
c-1	Łm-I	peat	1080±70	Gd-4802	770–1050 cal AD
c-2	Łm-II	peat	8820±120	Gd-7941	8236–7611 cal BC
c-3	Łm-III	shells	8150±110	Gd-2792	7482–6806 cal BC
c-4	Łm-IV	peat	1880±70	Gd-7046	39 cal BC–260 cal AD
c-5	Łm-IV	peat	3850±100	Gd-4276	2576–2027 cal BC
c-6	Łm-VI	peat	3300±100	Gd-2589	1831–1395 cal BC
c-7	Łm-VI	peat	1570±100	Gd-2523	315–635 cal AD

Table 2. Results of radiocarbon datings

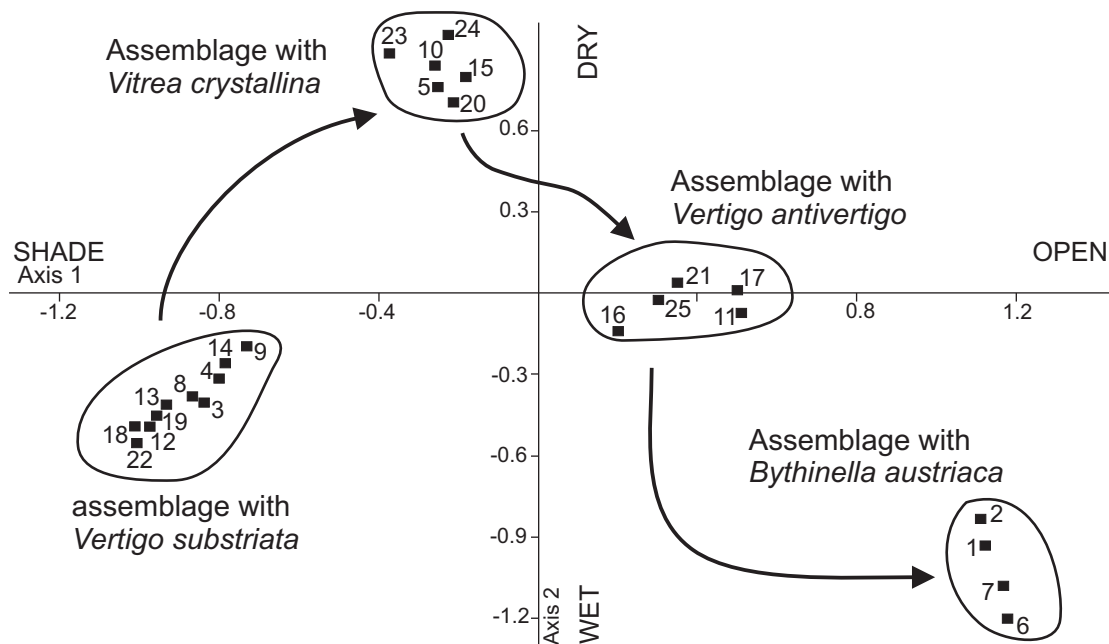

Text-fig. 6. Correspondence analysis diagram of molluscan assemblages from calcareous tufa and peat in Łapsze Niżne site

ula). Shade-loving gastropods are rare (Text-fig. 4). The assemblage is typical of high humidity open habitats (Text-figs 5, 6). Age determinations of deposits containing the assemblage point to the older part of the Subatlantic Phase: 39 cal BC–260 cal AD (profile Łm-IV; c-4), 315–635 cal AD (profile Łm-VI; c-7) and 770–1050 cal AD (profile Łm-I; c-1) (Text-fig. 3, Table 2). The described malacocoenosis was recognized in the top interval of the upper peat layer in profiles Łm-II, Łm-III and Łm-VI (Text-figs 3, 4)

The assemblage with *Bythinella austriaca* is characterized by the common occurrence of the stenotopic gastropod *Bythinella austriaca*. Terrestrial species are relatively rare. This association is typical of cold waters with stable temperatures (Text-figs 5, 6). The *Bythinella austriaca* assemblage occurs exclusively in calcareous tufas precipitated in the direct vicinity of springs. In the Łapsze Niżne, the discussed assemblage occurs only in the topmost part of the calcareous tufas exposed in profiles Łm-I and Łm-II (Text-figs 3, 4). This is the most typical malacocoenosis of calcareous tufa linked with historical times and has been described from numerous sites of such deposits in the Carpathians (Alexandrowicz 1997a, 2004, 2009, 2010, 2013b; Horsák and Hájek 2003; Horsák *et al.* 2007; Alexandrowicz *et al.* 2014, 2016).

DISCUSSION

Environmental changes

The oldest part of the succession is represented by a basal peat layer and a lower bed of calcareous tufas (Text-fig. 3). It is characterized by the assemblage with *Vertigo substriata* dwelling in humid habitats with a relatively cold climate (Text-figs 5, 6). Both radiocarbon datings (c-2 and c-3) (Table 2, Text-fig. 3) and structure of the fauna determine the age of the basal peat layer and the covering calcareous tufas as the Boreal and the older part of the Atlantic Phases (Text-fig. 7). The transition between peat and tufas is relatively sharp and rugged and points the first phase of erosion. The peat occurring above the sand layer contains the assemblage with *Vitrea crystallina*. Its presence indicates the development of more shaded and slightly dryer habitats (Text-figs 5, 6). There is also a lack of relic cold-tolerant species (*Semilimax kotulae*, *Columella columella*, *Vertigo genesii*). The abundance of Euro-Siberian and Boreal taxa (*Vertigo substriata*, *Discus ruderratus*, *Perforatella bidentata*), is also much lower. Radiometric dates (c-5 and c-6) (Text-fig. 3, Table 2) indicate that the discussed peat was formed during the Subboreal Phase, probably in its middle part (Text-fig. 7). Thus, the sand interbedding in the basal part of the peat records the cessation

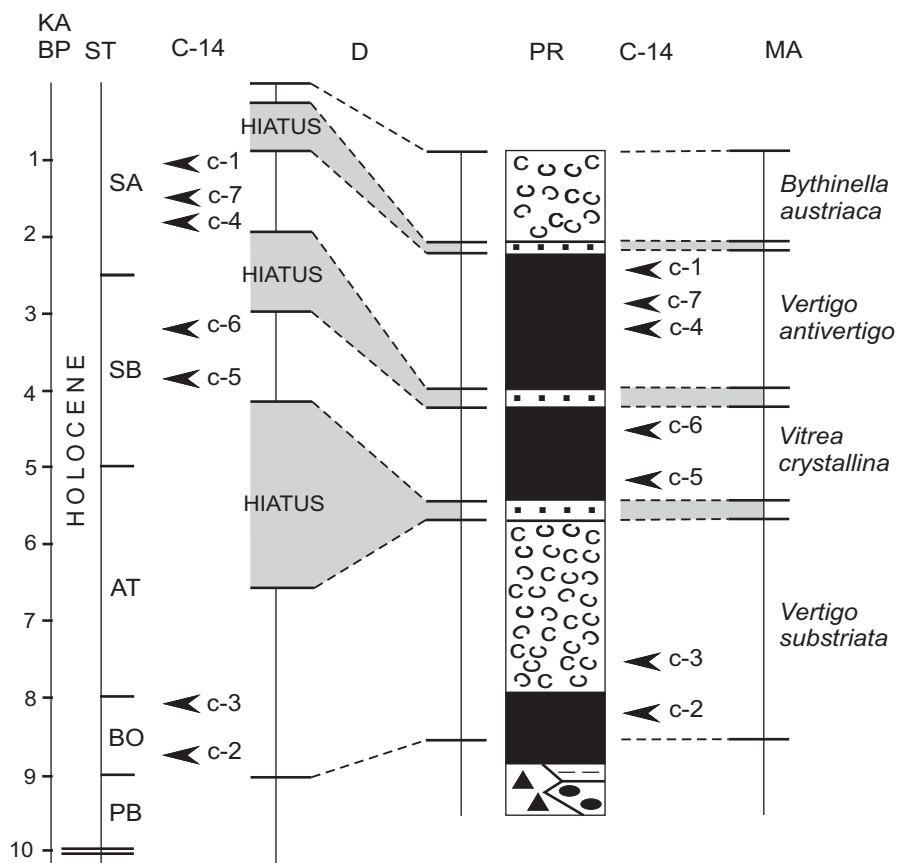

Text-fig. 7. Stratigraphical range of profile of calcareous tufa and peat in Łapsze Niżne site. KA BP – age in thousand years, ST. stratigraphical subdivision of Holocene: PB – Preboreal Phase, BO – Boreal Phase, AT – Atlantic Phase, SB – Subboreal Phase, SA – Subatlantic Phase, C-14 – radiocarbon datings, PR – synthetic lithological profile (for explanation see Text-fig. 3), MA – molluscan assemblages described in text

of sedimentation and erosion that took place during the middle and younger part of the Atlantic as well as probably in the older part of the Subboreal Phases (Text-fig. 7). The sand interbedding in the upper part of the peat points to the second phase of erosion. It separates the peat into the lower part described above and the upper part containing the assemblage with *Vertigo antivertigo* (Text-figs 3, 4). This interval is marked by the distinct increase in humidity of the biotopes associated with the disappearance of shaded habitats (Text-figs 5, 6). Three radiocarbon dates (c-1, c-4 and c-7) are linked with this part of the succession (Text-fig. 3, Table 2). They indicate that the peat with the *Vertigo antivertigo* assemblage were formed in the older part of the Subatlantic Phase (Text-fig. 7). Interbeddings of phytogenic deposits representing a similar interval were recognized in the topmost part of the tufa in Gliczarów: 210–415 cal AD; Gd-1644 and 531–1188 cal AD; Gd-2223 (Alexandrowicz 1997a, 2003). The sand layer separating the upper peat layer in Łapsze Niżne represents the strati-

graphic gap encompassing the younger part of the Subboreal Phase and probably also the beginning of the Subatlantic Phase (Text-fig. 7). In the proximal part of the fan, the peat is covered by a third sand layer, which marks a third phase of sedimentation cessation encompassing probably several hundred years (Text-fig. 7). The overlying calcareous tufas with the assemblage with *Bythinella austriaca* represent the last few hundred years. Despite the lack of radiocarbon dates, the determination of the stratigraphic position of this assemblage is possible due to its common occurrence and the descriptions in the literature of numerous, stratigraphically well documented sites of calcareous tufas and fluvial sediments across the Carpathians (Alexandrowicz 1997a, 2004, 2009, 2010, 2013b; Horsák and Hájek 2003; Horsák et al. 2007; Alexandrowicz et al. 2014, 2016). An additional indicator is the total lack of shade-loving species, which may be linked with anthropogenic deforestation. Traces of these processes are documented in several tufa profiles located at short distances

from the analysed site: Niedzica (1278–1417 cal AD; MKL-1345), Łapsze Wyżne (1647–1891 cal AD; Gd-4247), Falsztyn (1513–1815 cal AD; Gd-5105), as well as many sites in the central and northern part of the Podhale Basin (Alexandrowicz 1997a; 2010, 2013b; Alexandrowicz and Rybska 2013; Alexandrowicz *et al.* 2014).

Regional and local implications

Molluscs shells undergo the same processes of erosion, transport and accumulation as mineral grains. On the other hand, they have a smaller density (the shells are much lighter than mineral grains of the same dimensions) and much higher susceptibility to destruction. The first factor, at least theoretically, favours the transport of shell material whereas the second causes rapid removal of shells from the sediment. Studies on the preservation of mollusc shells in the flood sediments of the Carpathian rivers unequivocally indicate that redeposition of shells is minor and only at a short distance (usually not exceeding several hundred meters) (Alexandrowicz and Alexandrowicz 2011). Moreover, within wide valleys the transport takes place exclusively along the valley, whereas transverse transport is minimal (Čejka 2005). Similar restrictions refer to the vertical redeposition of shells or the mixing of material of different ages (Alexandrowicz and Alexandrowicz 2011). These observations indicate that the malacocoenoses represent habitats occurring at the time and place of sediment accumulation. This is the main reason why malacological analysis is the source of reliable data on the local environment. The environment is a mosaic of neighbouring microhabitats, often differing significantly from each other. Each

microhabitat yields a specific fauna and flora corresponding to the dwelling conditions (Horsák and Hájek 2003; Horsák *et al.* 2007). Therefore, regional interpretations based on malacofauna must be carried out on a larger amount of comparative material encompassing data from studies conducted in other (neighbouring) malacological sites. Invaluable support for such interpretations is the application (when possible) of data obtained with use of other research methods (e.g. lithological or palynological analysis) (Alexandrowicz and Alexandrowicz 2011). Due to these reasons, the precision of malacological analysis depends on the separation of local factors from regional features, which influence the composition and structure of the faunal assemblages.

The site of calcareous tufas and peat in Łapsze Niżne supplies a good base for such discussions. The evolution of the natural environment in the Podhale area during the Late Glacial and the Holocene is well known due to malacological studies carried out in numerous sites (Alexandrowicz 1997a, 2001, 2003, 2010, 2013a, b; Alexandrowicz and Rybska 2013; Alexandrowicz *et al.* 2014), as well as palynological analysis of many peatlands in the area (Obidowicz 1990; Chrynowiecka-Czmielewska 2009; Łajczak 2009). The results of these studies indicate the presence of a regional climatic trend. It is possible to distinguish several periods corresponding to particular faunal and floral assemblages (Table 3).

The oldest phase represents the Alleröd Interphase. This period is characterized by the presence of a fauna with *Semilimax kotulae*, indicating a cold climate and open habitats with patches of sparse forest and bushy undergrowth (Alexandrowicz 1997a, 2013a; Alexandrowicz *et al.* 2014). This interval is not documented in the palynological profiles from the

Stratigraphy	Podhale Basin			Łapsze Niżne	
	Molluscan assemblages (after: Alexandrowicz 1997a, 2004; Alexandrowicz <i>et al.</i> 2014)	Palinology (after: Obidowicz, 1990; Łajczak, 2009)	Environment	Molluscan assemblages	Environment
Subatlantic	<i>Bythinella austriaca</i> , <i>Monachoides vicinus</i> , <i>Vallonia pulchella</i> , <i>Vertigo anivertigo</i>	NAP <i>Carpinus–Abies–Fagus</i> ; <i>Fagus–Abies</i>	springs and streams; marches; meadows; wet coniferous forests	<i>Bythinella austriaca</i> , <i>Vertigo anivertigo</i>	springs; marches;
Subboreal	<i>Vitrea crystallina</i>	<i>Fagus–Abies</i> ; <i>Carpinus–Abies</i> ; <i>Picea</i>	busches and light forests	<i>Vitrea crystallina</i>	busches and light forests
Atlantic	<i>Discus perspectivus</i>	<i>Ulmus–Tilia–Quercus– Fraxinus</i> ; <i>Corylus</i>	mixed and deciduous forests	<i>Vertigo substriata</i>	marches and light forests
Boreal	<i>Discus ruderatus</i>	<i>Corylus</i> ; <i>Ulmus</i> ; <i>Berula</i>	coniferous forests		
Preboreal	<i>Vertigo substriata</i>	<i>Pinus</i>	marches and light forests	?	?
Younger Dryas	<i>Vertigo genesii</i>	NAP	marches	?	?
Alleröd	<i>Semilimax kotulae</i>	?	busches and light forests	?	?

Table 3. Comparison of environmental and climatic changes during deposition of calcareous tufa in Podhale Basin in the light of malacological and palinological data

Podhale peatlands (Obidowicz 1990; Chrynowiecka-Czmielewska 2009; Łajczak 2009). Cooling during the Younger Dryas recorded as NAP phase (Obidowicz 1990; Chrynowiecka-Czmielewska 2009; Łajczak 2009) (Table 3) resulted in the development of wet, open habitats with the assemblage containing *Vertigo genesii* (Alexandrowicz 1997a, 2004, 2013a; Alexandrowicz et al. 2014). The connection of the assemblage with *Vertigo genesii* with the Younger Dryas has also been confirmed in numerous profiles across Europe (e.g. Ložek 1964; Preece 1998; Alexandrowicz 1983, 1997b, 2004, 2015; Limondin-Lozouet and Rousseau 1991; Limondin-Lozouet 1992; Krolopp and Sümegi 1993; Preece and Day 1994; Alexandrowicz and Alexandrowicz 1995a, b; Meyrick 2001, 2002; Meyrick and Preece 2001; Gedda 2001, 2006). Proceeding warming is marked from the beginning of the Holocene. Forests gradually stride into the Podhale area (*Pinus* phase; Obidowicz 1990; Chrynowiecka-Czmielewska 2009; Łajczak 2009). Malacological profiles from that interval are characterized by the presence of a fauna with *Vertigo substriata* (Alexandrowicz 1997a, 2013a) (Table 3). It has also been described from numerous profiles across Europe (e.g. Alexandrowicz 1983, 1997b, 2004; Limondin-Lozouet and Rousseau 1991; Gedda 2001, 2006; Meyrick 2002; Limondin-Lozouet 2011). In the Boreal Phase, the fauna with *Vertigo substriata* was replaced by the assemblage with *Discus ruderatus* characteristic of coniferous, tajga-type forests (pollen phases *Corylus*, *Ulmus* and *Betula*) (Obidowicz 1990) developing in a relatively cold climate (Alexandrowicz 1997a, 2001, 2003, 2013a; Alexandrowicz and Rybska 2013; Alexandrowicz et al. 2014) (Table 3). The mollusc assemblage corresponds to the *Ruderatus*-fauna characteristic of the Early Holocene (Dehm 1967; Preece 1998; Preece and Bridgland 1999) which has been described from many sites across Europe (e.g. Ložek 1964, 2000; Alexandrowicz 1983, 1997b, 2004; Preece and Day 1994; Alexandrowicz and Alexandrowicz 1995a, b; Preece 1998; Preece and Bridgland 1999; Gedda 2001; Žak et al. 2002; Meyrick 2002; Limondin-Lozouet and Preece 2004; Hlaváč 2006; Limondin-Lozouet 2011; Juříčková et al. 2014a; Horáčková et al. 2015). The Atlantic Phase mixed and deciduous forests develop (*Ulmus–Tilia–Quercus–Fraxinus* and *Corylus* phases) (Obidowicz 1990; Chrynowiecka-Czmielewska 2009; Łajczak 2009). In a warm and humid climate with distinct oceanic influences developed the fauna with *Discus perspectivus* (Alexandrowicz 1997a, 2001, 2003; Alexandrowicz and Rybska 2013) (Table 3). It corresponds to the *Perspectivus*-fauna (Dehm 1987) and

has been described from many other sites (e.g. Ložek 1964; Alexandrowicz 1983, 1997b, 2004; Füköh 1995; Dehm 1987; Mania 1973, 1995; Alexandrowicz and Alexandrowicz 1995a, b; Preece and Bridgland 1998; Meyrick 2002). Deterioration of climatic conditions in the Subboreal Phase caused slight reduction of forested areas (*Fagus–Abies*, *Carpinus–Abies* and *Picea* phases; Obidowicz 1990; Chrynowiecka-Czmielewska 2009; Łajczak 2009), as well as distinct impoverishment of mollusc fauna (*Vitrea crystallina* assemblage; Alexandrowicz 1997a, 2003). During the Subatlantic Phase, climatic changes were influenced by human activity. In the older part of the Subatlantic Phase forest assemblages dominated in the Podhale area (*Carpinus–Abies–Fagus* and *Fagus–Abies* phases; Obidowicz 1990; Chrynowiecka-Czmielewska 2009; Łajczak 2009). Small peatlands also developed. This interval is characterized by the presence of the *Vertigo antivertigo* assemblage (Alexandrowicz 1997a, 2003). Anthropogenic influence is marked in the Podhale area from the XIIIth century. Introduction of an agricultural and pastoral economy resulted in significant deforestation mainly within the flat, northern part of Podhale and in the wide valleys of larger rivers (Alexandrowicz 2013b). In palynological profiles these processes are evidenced by the increased contribution of green plant pollen, including that of cultivated plants, and an accompanying significant decrease of tree pollen abundance (NAP phase; Obidowicz 1990; Chrynowiecka-Czmielewska 2009; Łajczak 2009). With this interval is linked the occurrence of diverse malacocoenoses, with the characteristic *Bythinella austriaca* fauna typical of calcareous tufas accumulated near springs (Alexandrowicz 1997a, 2004, 2009, 2010; Horsák and Hájek 2003; Horsák et al. 2007; Alexandrowicz et al. 2014, 2016) (Table 3).

Presented above, in the Łapsze Niżne, upon the regional trend of environmental changes generated mainly by climatic fluctuations are superimposed local factors that cause significant modifications (Text-fig. 7, Table 3). The most significant differences are as follows:

The assemblage with *Vertigo substriata* appears in the Boreal Phase, and not as in other profiles in the Preboreal Phase. It also has a much longer range (till the beginning of the Atlantic Phase). On the other hand there are no assemblages with a large contribution of shade-loving species in the site (fauna with *Discus ruderatus* and with *Discus perspectivus*), characteristic of the Boreal and Atlantic Phases. These observations indicate that the area of tufa and peat deposition in Łapsze Niżne in this inter-

val was characterized, in contrast with most of the Podhale area, by the presence of humid, rather open habitats covered by sparse bushes. The presence of *Perforatella bidentata* indicates the occurrence of alder. It is possible that the shells of *Discus rudersatus* were redeposited from the slope. The presence of cold-loving species (*Columella columella*, *Vertigo genesii* and *Semilimax kotulae*) is typical for the sediments of the Boreal Phase and the beginning of the Atlantic Phase occurring in the Podhale area. These are glacial relics remaining in the area due to regional climate and specific morphology (Alexandrowicz 1997a, 2004, 2013a; Alexandrowicz and Rybska 2013; Alexandrowicz *et al.* 2014). A low contribution of shade-loving forms throughout the entire deposition of sediments exposed in the profiles at Łapsze Niżne is the most significant feature differing this site from other sites in the Podhale area. This is also the crucial factor influencing the specific variability (Text-fig. 7, Table 3).

In contrast to the majority of calcareous tufa profiles in the Podhale basin, there is a gap in sedimentation falling in the younger part of the Atlantic Phase. This is probably linked with erosion, which is recorded in the sand interbedding observed in the Łapsze Niżne profiles. Most probably this interval of erosion may be linked with enhanced fluvial processes during the Atlantic Phase (Starkel *et al.* 2006) (Text-fig. 7, Table 3).

Malacofauna is present in deposits linked with the younger part of the Subboreal Phase. In a lot of sites in Europe this interval is linked with a stratigraphic gap and with traces of erosion (e.g. Ložek 1964; Jäger and Ložek 1968; Alexandrowicz 1983, 2004; Pazdur 1987; Pazdur *et al.* 1988a, b; Goudie *et al.* 1993; Dobrowolski *et al.* 2005, 2012; Limondin-Lozouet *et al.* 2013). The undisputed specific feature of the Łapsze Niżne site is the presence of mollusc shells in peat. Peat represents acidic deposits which negatively influence the preservation of mollusc shells. Shell material does not occur in any other Podhale peatland. However, in specific conditions linked with the presence of waters with high calcium carbonate content, the process of shell solution may be restricted or even completely inhibited, which allows sub-fossilized preservation of mollusc shells (Text-fig. 7, Table 3).

CONCLUSIONS

The presented characteristics of the malacofauna occurring in the profiles of peat and calcareous tufas

in the Łapsze Niżne location constitutes an example of the use of malacological studies to reconstruct regional climatic trends as well as analyses of local environmental conditions. In Łapsze Niżne, the malacofauna shows a different composition and sequence of faunistic associations from these of neighbouring profiles. These significant differences result from the modification of regional conditions by local factors. During the Holocene, the area of Podhale was covered by forests. This is indicated by the results of both palynological and malacological studies. Within this forested area, however, there were some isolated ranges not overgrown by forests. On the one hand, these were extremely dry areas associated with the occurrence of calcareous rocks where associations with high proportions of organisms living on open rocks, and those inhabiting dry, sometimes xerothermic grassland biotopes occur. On the other hand, boggy zones with high levels of humidity were overgrown only by bushes or alder scrub. This latter case is illustrated by the profile at Łapsze Niżne. These observations indicate that, both now and in the past, the area of Podhale was a mosaic of microhabitats of diversified features, inhabited by various plant and animal associations. This rule is observed today in all geographical regions, without any exception, and it undoubtedly occurred similarly in the past. With respect to the Quaternary period, and particularly to the Late Glacial and Holocene, malacological analysis is one of the best and most sensitive methods allowing the reconstruction of the diversification of habitats within geographical regions. This is firstly, because of the universal occurrence of mollusc shells in deposits of various origins, thus representing various types of habitats. Secondly, it is because of the close relationship between the composition and ecological structure of the animal associations and the features of the environment in the depositional zone. Thirdly, the limited mobility of the shell material causes a close correspondence between the malacocoenoses and the conditions in the place and time of deposition of the sediments. Fourthly, malacological analysis provides the opportunity to separate the regional factors characterized on the basis of the examinations of many profiles in a given area, from the local factors identified from the analysis conducted in individual locations. For all these reasons, the studies of sub-fossil faunas of molluscs can enrich our knowledge of the evolution of the environment in geographical regions, taking into account the diversity of habitats within them.

The reconstructions of microhabitat evolution within geographical regions are of major significance

to broadening our knowledge. On the one hand, they allow the characterization of the malacofauna, and enable us particularly to learn about the occurrence of specific species showing the ranges limited in a given time. It pertains chiefly to the taxa which are rare or at risk of extinction, living as isolated populations. Such places constitute refugia enabling survival, and – in the case of the occurrence of favourable conditions – also enabling rapid colonization of neighbouring areas. In a very great number of malacological profiles, the sudden and rapid appearance of certain species or even their whole associations is observed, following the changed features of the environment. This phenomenon is difficult to explain only on the basis of migration processes and the arrival of forms living in other geographical regions. A much more probable explanation is that there were small, isolated habitats where the species could survive and later spread. This possibility indicates that the reaction of molluscs to a change in conditions, perceived as a reconstruction of the composition and structure of associations can happen rapidly following changes in the features of the environment and climate. The issue of refugia and relict species have been discussed in numerous malacological studies. They focused on both analysing forest faunas in cold periods (e.g. Ložek 2000; Horsák *et al.* 2007; Cameron *et al.* 2011, 2013; Juříčková *et al.* 2014a, b), as well as on the survival of cold-loving species during the progressive climate warming (Alexandrowicz 1997a, 2004, 2013a; Hájek *et al.* 2011; Schenková and Horsák 2013). The climatic conditions prevailing in the Podhale basin enable[d] the survival of relict population[s] of the species typical of the glacial period. The occurrence of *Semilimax kotulae*, *Vertigo geyeri*, *Vertigo genesii*, *Columella columella*, as well as several other taxa, was noted in many sites even during the period of climatic optimum (Alexandrowicz 1997a, 2004, 2013a). The first two species live in the Podhale basin at present (Wiktor 2004; Schenková *et al.* 2012). These observations confirm the major importance of the studies of microhabitats, both fossil and contemporary. The significance of these observations can be very great for the course of both in time- and palaeoenvironment-related interpretation. On the other hand, however, these investigations reveal the diversity among habitats linked to local conditions within the regions. It should be emphasised that the recognition of the diversity of microhabitats using the properties of the malacofauna can be successfully conducted in the areas thoroughly studied (on the basis of e.g. malacological, palynological, geological analyses) in terms of regional climate and environmental conditions and trends.

Acknowledgements

This study has been sponsored by AGH University of Science and Technology through the University grant no 11.11.140.005. The authors would like to thank N. Limondin-Lozouet and an anonymous reviewer for their insightful reviews of the manuscript. We are also grateful to the Editor Ireneusz Walaszczyk for valuable comments.

REFERENCES

- Alexandrowicz, S.W. 1983. Malakofauna of the Holocene calcareous sediments of the Cracow Upland. *Acta Geologica Polonica*, **33**, 117–158.
- Alexandrowicz, S.W. 1997b. Malakofauna of Holocene Sediments of the Prądnik and Rudawa River Valleys (Southern Poland). *Folia Quaternaria*, **68**, 133–188.
- Alexandrowicz, S.W. and Alexandrowicz, W.P. 1995a. Quaternary molluscan assemblages of the Polish Carpathians. *Studia Geomorphologica Carpatho-Balcanica*, **29**, 41–54.
- Alexandrowicz, S.W. and Alexandrowicz, W.P. 1995b. Molluscan fauna of the Upper Vistulian and Early Holocene sediments of South Poland. *Biuletyn Peryglacjalny*, **34**, 5–19.
- Alexandrowicz, S.W. and Alexandrowicz, W.P. 2011. Malacological analyses methods of investigation and interpretation. *Rozprawy Wydziału Przyrodniczego PAU*, **3**, 5–302. [In Polish].
- Alexandrowicz, W.P. 1997a. Malacofauna of Quaternary deposits and environmental changes of the Podhale Basin during the Late Glacial and Holocene. *Folia Quaternaria*, **68**, 7–132. [In Polish with English summary].
- Alexandrowicz, W.P. 2001. Late Vistulian and Holocene molluscan assemblages from calcareous tufa at Ostrysz Hill (Podhale Basin). *Folia Malacologica*, **9**, 159–169.
- Alexandrowicz, W.P. 2003. The exposure of calcareous tufa in Gliczarów in the Podhale Basin. *Chrońmy Przyrodę Ojczystą*, **53**, 17–31. [In Polish with English summary].
- Alexandrowicz, W.P. 2004. Molluscan assemblages of Late Glacial and Holocene calcareous tufas in Southern Poland. *Folia Quaternaria*, **75**, 1–309.
- Alexandrowicz, W.P. 2009. Malacofauna of Upper Holocene calcareous tufa in the Western Beskidy Mts (Southern Poland). *Geologia, Kwartalnik AGH*, **35**, 175–200.
- Alexandrowicz, W.P. 2010. Molluscan assemblages of recent calcareous tufas in the Podhale Basin and Pieniny Mts (S. Poland). *Folia Malacologica*, **18**, 99–112.
- Alexandrowicz, W.P. 2013a. Malacological sequence from profile of calcareous tufa in Groń (Podhale Basin, southern Poland) as an indicator of the Late Glacial/Holocene boundary. *Quaternary International*, **293**, 196–206.
- Alexandrowicz, W.P. 2013b. Molluscan communities in Late Holocene fluvial deposits as an indicator of human activ-

- ity: a study in Podhale Basin in South Poland. *Ekologia Bratislava*, **32**, 111–125.
- Alexandrowicz, W.P. 2015. The application of malacological analysis in the study of slope deposits: Late Pleistocene and Holocene of the Podhale Basin (Carpathians, Poland). *Acta Geologica Polonica*, **65**, 245–261.
- Alexandrowicz, W.P. and Rybska, E. 2013. Environmental changes of intramontane basins derived from malacological analysis of profile of calcareous tufa in Niedzica (Podhale Basin, Southern Poland). *Carpathian Journal of Earth and Environmental Sciences*, **8**, 13–26.
- Alexandrowicz, W.P., Szymanek, M. and Rybska, E. 2014. Changes to the environment of intramontane basins in the light of malacological research of calcareous tufa: Podhale Basin (Carpathians, Southern Poland). *Quaternary International*, **353**: 250–265.
- Alexandrowicz, W.P., Szymanek, M. and Rybska, E. 2016. Molluscan assemblages from Holocene calcareous tufa and their significance for palaeoenvironmental reconstructions. A study in the Pieniny Mountains (Carpathians, southern Poland). *Carpathian Journal of Earth and Environmental Sciences*, **11**, 37–54.
- Bąk, K. 1992. Possibilities of Scheibler method application in researches on calcium carbonate content in solid carbonate rocks. *Rocznik Naukowo-Dydaktyczny WSP (Prace Geograficzne)*, **14**, 131–139.
- Bronk Ramsey, C. 2003. OxCal Program 3.9. University of Oxford. Radiocarbon Accelerator Unit.
- Cameron, R.A.D., Pokryszko, B.M., Horsák, M., Sirbu, I. and Gheoca, V. 2011. Forest snail faunas from Transylvania (Romania) and their relationship to the faunas of Central and Northern Europe. *Biological Journal of the Linnean Society*, **104**, 471–479.
- Cameron, R.A.D., Pokryszko, B.M. and Horsák, M. 2013. Forest snail faunas from Crimea (Ukraine), an isolated and incomplete Pleistocene refugium. *Biological Journal of the Linnean Society*, **109**, 424–433.
- Chrynowiecka-Czmielewska, A. 2009. Overview of palaeobotanical investigations on the Quaternary in the Tatra Mts., Pieniny Mts. and Podhale region. *Przegląd Geologiczny*, **57**, 714–718. [In Polish with English summary].
- Čejka, T. 2005. The mollusc fauna changes along a moisture gradient across the lower Morava River floodplain (SW Slovakia). *Malacological Newsletter*, **23**, 159–167.
- Dehm, R. 1967. Die landschnecke *Discus ruderatus* im Postglazial Süddeutschlands. *Mitteilungen der Bayerische Staatssammlung für Paläontologie und Historische Geologie* **7**, 135–155.
- Dehm, R. 1987. Die landschnecke *Discus perspectivus* im Postglazial Südbayerns. *Mitteilungen der Bayerische Staatssammlung für Paläontologie und Historische Geologie*, **27**, 21–30.
- Dobrowolski, R., Hajdas, I., Melke, J. and Alexandrowicz, W.P. 2005. Chronostratigraphy of calcareous mire sediments at Zawadówka (Eastern Poland) and their use in palaeogeographical reconstruction. *Geochronometria*, **24**, 69–79.
- Dobrowolski, R., Pidek, I.A., Alexandrowicz, W.P., Hałas, S., Pazdur, A., Piotrowska, N., Buczek, A., Urban, D. and Melke, J. 2012. Interdisciplinary studies of spring mire deposits from Radzików (South Podlasie Lowland, East Poland) and their significance for palaeoenvironmental reconstructions. *Geochronometria*, **39**, 10–29.
- Füköh, L. 1995. History of the Hungarian Holocene mollusc fauna. *Geojournal*, **36**, 255–259.
- Gedda, B. 2001. Environmental and climatic aspects of the Early and Mid Holocene calcareous tufa and land mollusc fauna in southern Sweden. *Lundqua Thesis*, **45**, 1–50.
- Gedda, B. 2006. Terrestrial mollusc succession and stratigraphy of a Holocene calcareous tufa deposit from the Fyledalen valley, southern Sweden. *The Holocene*, **16**, 137–147.
- Goudie, A.S., Viles, H.A. and Pentecost, A. 1993. The late-Holocene tufa decline in Europe. *The Holocene*, **3**, 181–186.
- Hájek, M., Horsák, M., Tichý, L., Hájková, P., Dítě, D. and Jamrichová E. 2011. Testing a relict distributional pattern of fen plant and terrestrial snail species at the Holocene scale: a null model approach. *Journal of Biogeography*, **38**, 742–755.
- Hammer, Ø., Harper, D.A.T. and Ryan, P.D. 2001. Past: paleontological statistics software package for education and data analysis. *Palaeontologica Electronica*, **4**, 1–9.
- Hlaváč, J. 2006. Molluscan succession from Holocene tufas in the Czech Karst (Czech Republic). *Geologica Carpathica*, **57**, 405–414.
- Horáčková, J., Ložek, V. and Juříčková, L. 2015. List of malacologically treated Holocene sites with brief review of palaeomalacological research in Czech and Slovak Republics. *Quaternary International*, **357**, 207–211.
- Horsák, M. and Hájek, M. 2003. Composition and species richness of molluscan communities in relation to vegetation and water chemistry in the Western Carpathian spring fans: the poor-rich gradient. *Journal of Molluscan Studies*, **69**, 349–357.
- Horsák, M., Hájek, M., Dítě, D. and Tichý, L. 2006. Modern distribution patterns of snails and plants in the western Carpathian spring fans: is it a result of historical development? *Journal of Molluscan Studies*, **73**, 53–60.
- Jäger, K.D. and Ložek, V. 1968. Beobachtungen zur Geschichte der Karbinatdynamik in der holozänen Warmzeit. *Československy Kras*, **19**, 5–20.
- Juříčková, L., Horsák, M., Horáčková, J., Abraham, V. and Ložek, V. 2014a. Patterns of land-snail succession in Central Europe over the last 15,000 years: main changes along environmental, spatial and temporal gradients. *Quaternary Science Reviews*, **93**, 155–166.
- Juříčková, L., Horáčková, J. and Ložek, V. 2014b. Direct evidence of Central European forest refugia during the Last

- Glacial Period based on mollusc fossils. *Quaternary Research*, **82**, 222–228.
- Kerney, M.P., Cameron, R.A.D. and Jungbluth, J.H. 1983. Die Landschnecken Nord- und Mitteleuropas, 384 pp. P. Parey; Hamburg-Berlin.
- Krolopp, E. and Sümegei P. 1993. *Vertigo modesta* (Say 1924), *Vertigo geyeri* Lindholm 1925 and *Vertigo genesii* (Gredler 1856) species in Pleistocene formations of Hungary. *Malacological Newsletter*, **12**, 9–14.
- Limondin-Lozouet, N. 1992. Biographie Holocene de *Vertiginidae* (Mollusca – Gastropoda) Europeens: relations la dernière deglaciation. *Comptes Rendus de l'Académie des Sciences Paris*, **315**, 1281–1287.
- Limondin-Lozouet, N. 2011. Successions malacologiques à la charnière Glaciaire/ Interglaciaire: du modèle Tardiglaciaire-Holocène aux transitions du Pleistocène. *Quaternaire*, **22**, 211–220.
- Limondin-Lozouet, N. and Preece, R.C. 2004. Molluscan successions from the Holocene tufa of St Germain-le-Vasson, Normandy (France) and their biogeographical significance. *Journal of Quaternary Science*, **19**, 55–71.
- Limondin-Lozouet, N. and Preece, R.C. 2014. Quaternary perspectives on the diversity of land snail assemblages from northwestern Europe. *Journal of Molluscan Studies*, **80**, 224–237.
- Limondin-Lozouet, N., Preece, R.C. and Antoine, P. 2013. The Holocene tufa at Daours (Somme Valley, northern France): Malacological succession and palaeohydrological implications. *Boreas*, **42**, 650–663.
- Limondin-Lozouet, N. and Rousseau, D.D. 1991. Holocene climate as reflected by a malacological sequence at Verriers, France. *Boreas*, **20**, 207–229.
- Ložek, V. 1964. Quartärmollusken der Tschechoslowakei. *Rozprawy Ustředního Ústavu Geologického*, **31**, 1–374.
- Ložek, V. 2000. Palaeoecology of Quaternary Mollusca. *Antropozoikum*, **24**, 35–59.
- Łajczak, A. 2009. Development conditions and distribution of peat bogs in the Orava-Nowy Targ Basin. *Przegląd Geologiczny*, **57**, 694–702. [In Polish with English summary].
- Mangerud, J., Andersen, S.T., Berglund, B.E. and Donner, J. 1974. Quaternary stratigraphy of Norden, a proposal for terminology and classification. *Boreas*, **3**, 109–126.
- Mania, D. 1973. Paläoökologie, Faunenentwicklung und Stratigraphie des Eiszeitalters im mittleren Elb-Saalegebiet auf Grund von Molluskengesellschaften. *Geologie Beiheft*, **78–79**, 1–175.
- Mania, D. 1995. The influence of Quaternary climatic development on the Central European mollusc fauna. *Acta Zoologica Cracoviensia*, **38**, 17–34.
- Mastella, L. 1975. Flysch tectonics in the eastern part of the Podhale Basin, Carpathians, Poland. *Annales Societatis Geologorum Poloniae*, **45**, 361–401. [In Polish with English summary]
- Mastella, L. and Rybak-Ostrowska, B. 2012. Tectonic control of tufa occurrences in the Podhale Synclinorium (Central Western Carpathians, southern Poland). *Geological Quarterly*, **56**, 733–744.
- Meyrick, R.A. 2001. The development of terrestrial mollusc faunas in the 'Rheinland region' (western Germany and Luxembourg) during the Lateglacial and Holocene. *Quaternary Science Reviews*, **20**, 1667–1675.
- Meyrick, R.A. 2002. Holocene molluscan faunal history and environmental change at Kloster Mühle, Rheinland-Pfalz, western Germany. *Journal of Quaternary Science*, **18**, 121–132.
- Meyrick, R.A. and Preece, R.C. 2001. Molluscan successions from two Holocene tufas near Northampton, English Midlands. *Journal of Biogeography*, **28**, 77–93.
- Morisita, M. 1959. Measuring of interspecific association and similarity between communities. *Memoris of the Faculty of Sciences, Kyushu University*, **3**, 65–80.
- Obidowicz, A. 1990. Eine pollenanalytische und moorkundliche Studie zur Vegetationsgeschichte des Podhale-Gebietes (West-Karpaten). *Acta Palaeobotanica*, **30**, 147–219.
- Pazdur, A. 1987. Isotopic composition of carbon and oxygen in Holocene calcareous tufa deposits. *Zeszyty Naukowe Politechniki Śląskiej*, **1019**, 14–75. [In Polish with English summary].
- Pazdur, A., Pazdur, M.F., Starkel, L. and Szulc, J. 1988a. Stable isotopes of the Holocene calcareous tufa in southern Poland as palaeoclimatic indicators. *Quaternary Research*, **30**, 177–189.
- Pazdur, A., Pazdur, M.F. and Szulc, J. 1988b. Radiocarbon dating of Holocene calcareous tufa from south Poland. *Radiocarbon*, **30**, 133–146.
- Preece, R.C. 1998. Mollusca. In: Preece, R.C. and Bridgland, D.R. (Eds), Late Quaternary environmental change in North-West Europe: excavations at Holywell Coombe, South-West England, pp. 158–212. Chapman & Hall; London.
- Preece, R.C. and Bridgland, D.R. 1999. Holywell Coombe, Folkestone: a 13,000 year history of an English chalkland valley. *Quaternary Science Reviews*, **18**, 1075–1125.
- Preece, R.C. and Day, S.P. 1994. Comparison of Post-glacial molluscan and vegetational successions from a radiocarbon-dated tufa sequence in Oxfordshire. *Journal of Biogeography*, **21**, 463–468.
- Ratajczak-Szczerba, M., Sobkowiak-Tabaka, I. and Okuniewska-Nowaczyk, I. 2014. Morphology and the bottom deposits of the palaeolake basin in the Jordanowo-Niesulice subglacial channel near Lubrza, the Lubusz Lakelands. *Studia Limnologica et Telmatologica*, **8**, 71–80. [In Polish with English summary]
- Schenkova V. and Horsák, M. 2013. Refugial populations of *Vertigo lilljeborgi* and *V. genesii* (Vertiginidae): new isolated occurrences in Central Europe, ecology and distribution. *American Malacological Bulletin*, **31**, 323–329.

- Schenkova V., Horsak M., Pleskova Z. and Pawlikowski P. 2012. Habitat preferences and conservation of *Vertigo geyeri* (Gastropoda: Pulmonata) in Slovakia and Poland. *Journal of Molluscan Studies*, **78**, 105–111.
- Starkel, L., Soja, R. and Michczyńska, D. J. 2006. Past hydrological events reflected in Holocene history of Polish Rivers. *Catena*, **66**, 24–33.
- Stuiver, M., Reimer, P.J., Bard, E., Beck, J.W., Burr, G.S., Hughen, K.A., Kromer, B., McCormac, F.G., van der Plicht, J. and Spurk, M. 1998. INTCAL98 Radiocarbon age calibration 24,000–0 cal BP. *Radiocarbon*, **40**, 1083–1127.
- Wiktor, A. 2004. Ślimaki lądowe Polski, pp. 3–302. Mantis; Olsztyn.
- Žak, K., Ložek, V., Kadlec, J., Hladikova, J. and Cilek, V. 2002. Climate-induced changes in Holocene calcareous tufa formations, Bohemian Karst, Czech Republic. *Quaternary International*, **91**, 137–152.

Manuscript submitted: 29th September 2016

Revised version accepted: 15th October 2017