

ELECTROCHEMICAL CAPACITOR TEMPERATURE FLUCTUATIONS DURING CHARGING/DISCHARGING PROCESSES

Stanisław Galla, Arkadiusz Szewczyk, Łukasz Lentka

Gdańsk University of Technology, Faculty of Electronics, Telecommunications and Informatics, G. Narutowicza 11/12, 80-233, Gdańsk, Poland (✉ galla@eti.pg.edu.pl, +48 58 347 2140, szewczyk@eti.pg.edu.pl, lukasz.lentka@gmail.com)

Abstract

The paper presents a proposal of using additional statistical parameters such as: standard deviation, variance, maximum and minimum increases of the observed value that were determined during measurements of temperature fields created on the surface of the tested electrochemical capacitor. The measurements were carried out using thermographic methods in order to support assessment of the condition of electrochemical capacitor under classic durability tests based on methods of determination of capacity and equivalent series resistance. The possibility of using some statistical parameters in assessment of the electrochemical capacitor quality was illustrated. The applied measurement methodology and the results of research associated with the classic methods of supercapacitors' assessment are presented. The obtained results indicate that the variability of some statistical parameters of temperature fields can be directly related to changing the values of standard parameters describing electrochemical capacitor, which are capacitance and equivalent series resistance.

Keywords: electrochemical capacitor, statistical parameters, quality, thermography.

© 2019 Polish Academy of Sciences. All rights reserved

1. Introduction

Measurements of properties of elements and devices by using thermographic imaging are currently used in many fields of science. These tests are included in the group of non-destructive tests. The paper presents the results of noise data analysis techniques applied to examination of fluctuations of electrochemical capacitors' temperature fields [1]. The techniques used in noise measurements were introduced to support the methods of data analysis employed in assessment of the electrochemical capacitor construction quality [1, 2]. As a result, it enabled to present the obtained data in more detail and to indicate the areas in which the phenomena determining the durability of a given structure occur most intensively. All works were performed under the project entitled: "Mechanism of charging/discharging processes at the electrode/electrolyte phase in supercapacitors", whose primary purpose is to develop methods of evaluating electrochemical capacitors, basing on analysis of both noise and thermal phenomena. To facilitate evaluation of the developed structures there were used not only traditional parameters, such as capacity

(C) and equivalent *series resistance* (ESR). In addition, the performed observations seem to be a perfect example showing that in the absence of fluctuations, it would be difficult to analyse the state-of-health of the object under examination (specimen). In such a situation we would deal with a homogeneous system exhibiting no differences. On the other hand, in the performed measurement process, a number of various fluctuations of an interfering nature appeared, which were associated with the observations. They are related to the applied measurement system, the observed specimens, the environment and the processes occurring in the examined objects. It should also be noted here that the measurement methodology presented in the work, which is based on the use of thermographic measurements, is characterized by lower accuracy in determining the temperature value than the calorimetric methods described, among others, in [3, 4]. The mentioned methodology enables to acquire much more accurate information about the temperature distribution on the surface of observed objects. Thus, in a non-destructive and non-interfering way, the conclusion regarding the condition of the tested specimen and a more precise characterization of the examined object is possible to be reached by analysing temperature field fluctuations. The basis for the thermographic evaluation applied in this paper are the results of research on the phenomenon of electromagnetic radiation within the range of infrared radiation emitted by any object located at temperatures above 0 K. The fundamentals and principles of thermographic measurements are described in more detail, among others, in [5–7] which describe basic conditions that should be taken into account in such a type of research. Performing thermographic measurements requires considering a number of various factors, which may have an impact on the recorded values of temperature fields, resulting not only from different types of non-homogeneities occurring in the structure but also from the physical properties of materials. The essential factors, which may have a significant impact on the recorded values of temperature fields, include, among others, the following:

- a) properties of the observed surface of the tested specimen, which include the type of material, the manufacturing method, colour, surface texture;
- b) changes of ambient temperature;
- c) variability of processes occurring in the tested specimen.

The key factors presented above usually occur together. Additionally, it should be remembered that specimens of electrochemical capacitors can be classified as the so-called complex structures, comprising two metal electrodes of rectangular shape enabling the charge flow between the terminals. The electrodes are covered by a carbon layer preserving the charge inside the pores. The space between the electrodes is filled with a separator and electrolyte solution. The current flowing between the terminals is distributed over the rectangular metal plate and the emitted heat depends on the resistance of the carbon layer and the resistance of the contact between the metal plate and the carbon layer. The structure was sealed in a pouch protecting the electrolyte from interacting with humidity.

In our studies we present a description of the constructed setup and the algorithm used to estimate statistical parameters of the observed temperature fluctuations in the tested specimens.

2. Measurement setup

Figure 1 presents a schematic diagram of the measurement setup [8]. In the research a thermal imaging camera VIGOCAM v.50 I was used. The basic technical parameters of the camera are given in Table 1. The tested specimens IV are protected from external fluctuations of temperature

fields by a casing II. In order to force charging/discharging processes, an Atlas – Sollich V power supply and measurement module was used (performing both the power supply and measurement functions, enabling at the same time to register the current test conditions).

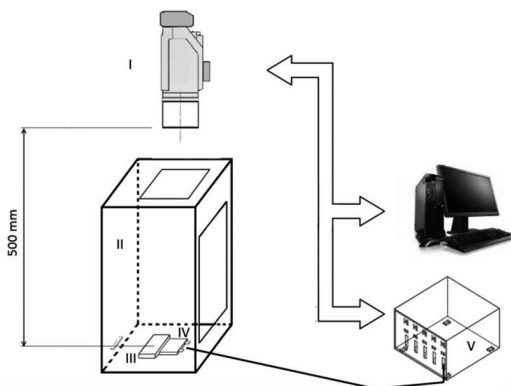

Fig. 1. A schematic diagram of the applied measurement system.

Table 1. Relevant parameters of VIGOCam v.50 camera [9].

Parameter	Value/Function Description
Detector type	Non-cooled bolometric matrix
Spectrum range	8 ÷ 14 μm
Image resolution	384 × 288
Thermal resolution	≤ 0.065°C (for temperature 30°C)
Field of vision	15°C × 11°C

The recorded data make possible to determine the parameters describing the state-of-health of an electrochemical capacitor (capacity C and equivalent series resistance ESR). Additionally, a reference field III was introduced into the camera observation area. Such an approach, however, does not provide full protection from fluctuations in the environmental temperature field as the estimated uncertainty of the determined temperature increment is at a level of 0.21°C. Both surfaces of the tested electrochemical capacitors IV and the inside of the casing were covered with a graphite layer [10]. The coating was used because one of the main problems that may occur during thermographic measurements is variability of the emissivity coefficient (ε) of the specimen, which is due to its physical properties (including colour, surface texture, temperature). The aforementioned properties may significantly change the emissivity coefficient (ε) in the analysed area. At the same time it is known, for instance, that the emissivity depends on the temperature and – in the case of metals – it increases with raising temperature, whereas in the case of non-metals – it decreases [5, 11, 12]. Normalizing the surface of the tested specimens with the use of the graphite coating enables to obtain the emissivity coefficient value $\varepsilon = 0.8$. Fig. 2 shows a typical specimen of electrochemical capacitor with a graphite coating.



Fig. 2. A photograph of a tested electrochemical capacitor specimen with a graphite coating.

3. Measurement algorithm

The general methodology of the research assumes that during the trials the following stages of measurements should be kept:

- pre-conditioning of tested electrochemical capacitors in order to bring a specimen into thermodynamic equilibrium without performing thermographic measurements;
- stage 1 – thermographic measurements without power supply;
- stage 2 – thermographic measurements during charging/discharging processes;
- stage 3 – thermographic measurements during cooling to the ambient temperature.

Due to the nature of charging/discharging processes occurring in electrochemical capacitor, the measurements were divided into long-term and short-term ones. The long-term tests were carried out within a measurement period $T = 60$ sec, enabling to record thermo-grams from stages 1 to 3 and were not limited in terms of the number of acquired images. The short-term measurements, due to the construction of the camera, are limited to acquiring a maximum of 400 thermo-grams. They were carried out for stage 1 and stage 2 subsequently within a measurement period $T = 0.5$ sec. The recorded data containing thermographic images of tested specimens were analysed later. The data analysis was carried out in accordance with the algorithm presented in Fig. 3. Assessment of the condition of the tested specimen consisted of evaluation of basic statistical parameters, which were obtained from the thermo-grams, in relation to the accepted criteria of changes in the capacitance (C) and ESR. This approach enabled to link statistical parameters with standard methods used in assessment of the electrochemical capacitor state-of-health.

During the thermographic measurements, thermographic images (B) showing the observed surface were obtained. The recorded measurement series consists of N images acquired within a fixed period of measurement T . The recorded image is an N matrix containing 388×288 temperature data. The variability of registered records enables to determine selected statistical parameters. To assess their usefulness, the following basic statistical factors were selected:

1. average and maximum temperature increments;
2. standard deviation;
3. variance;
4. kurtosis;
5. skewness;
6. spectral density.

Figure 3 presents the applied algorithm.

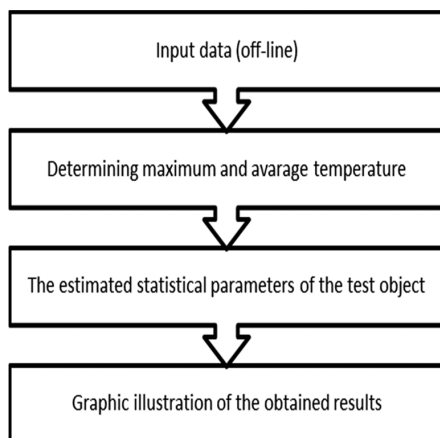

Fig. 3. A graph of the algorithm used to determine thermal parameters [8].

4. Specimen measurement results

Typical results obtained from analysis of the thermo-grams are in correlation with the basic parameters describing the degradation processes represented by the change in capacity or increase in ESR. Standard methods of assessment of electrochemical capacitors' quality assume that the tested specimen is treated as degraded if either its capacity decreases by at least -30% or ESR increases by 100% in relation to its initial values [13, 14].

The voltage during the current cycling and temperature increment changes (ΔT) of electrochemical capacitor as functions of time are presented in Fig. 4. The waveforms illustrate temperature fluctuations during charging/discharging processes on specimen P1 during short-term measurements.

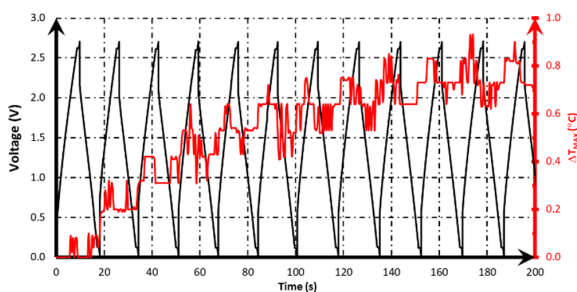

Fig. 4. Observed maximum temperature increments (red) on the surface of specimen P1 accompanying the electrochemical capacitors charging/discharging processes (at the charging voltage of up to 2.7 V and current of 290 mA) for stage 2, short-term measurements.

The next figures show statistical parameters that were considered useful in terms of data analysis. Fig. 5 shows the variances of temperature for stage 1, when the examined specimen is not powered (the moment corresponding to the beginning of the test is presented in Fig. 4). The obtained variance image for step 2, when the charging/discharging process is carried out is shown in Fig. 6.

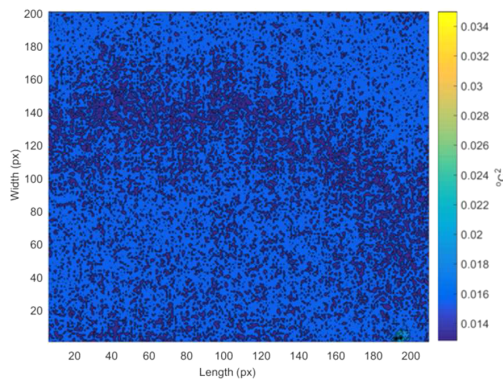

Fig. 5. A variance image of the observed surface of tested electrochemical capacitors without performing the charging/discharging processes.

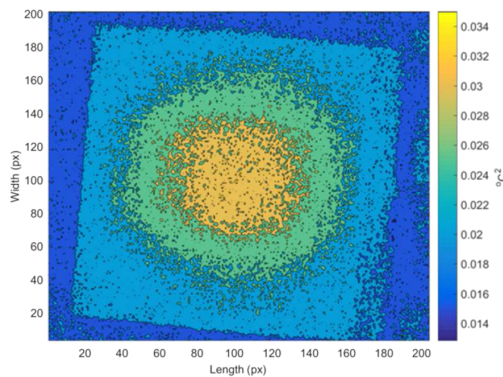

Fig. 6. A variance image of the observed surface of tested electrochemical capacitors while carrying out the charging/discharging processes for specimen P1 ($U = 2.7$ V, $I = 290$ mA), stage 2.

Figure 7 presents the temperature increment recorded during the test in which changes in the electrical parameters of the electrochemical capacitor (C and ESR) occurred. Accompanying changes in maximum temperature increments (ΔT_{MAX} , red) are observed.

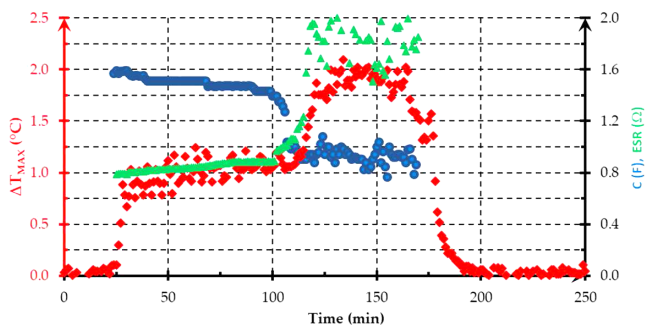

Fig. 7. Changes in maximum temperature increment (ΔT_{MAX}), capacitance (C) and equivalent series resistance (ESR) recorded during the tests of specimen P2 ($I = 306$ mA and $U = 2.7$ V).

Figure 8 presents statistical parameters, which were estimated during a long-term test for a measurement period when no changes in the electrical parameters of the tested electrochemical capacitor were recorded (a period between 25 and 100 minutes of P2 specimen test).

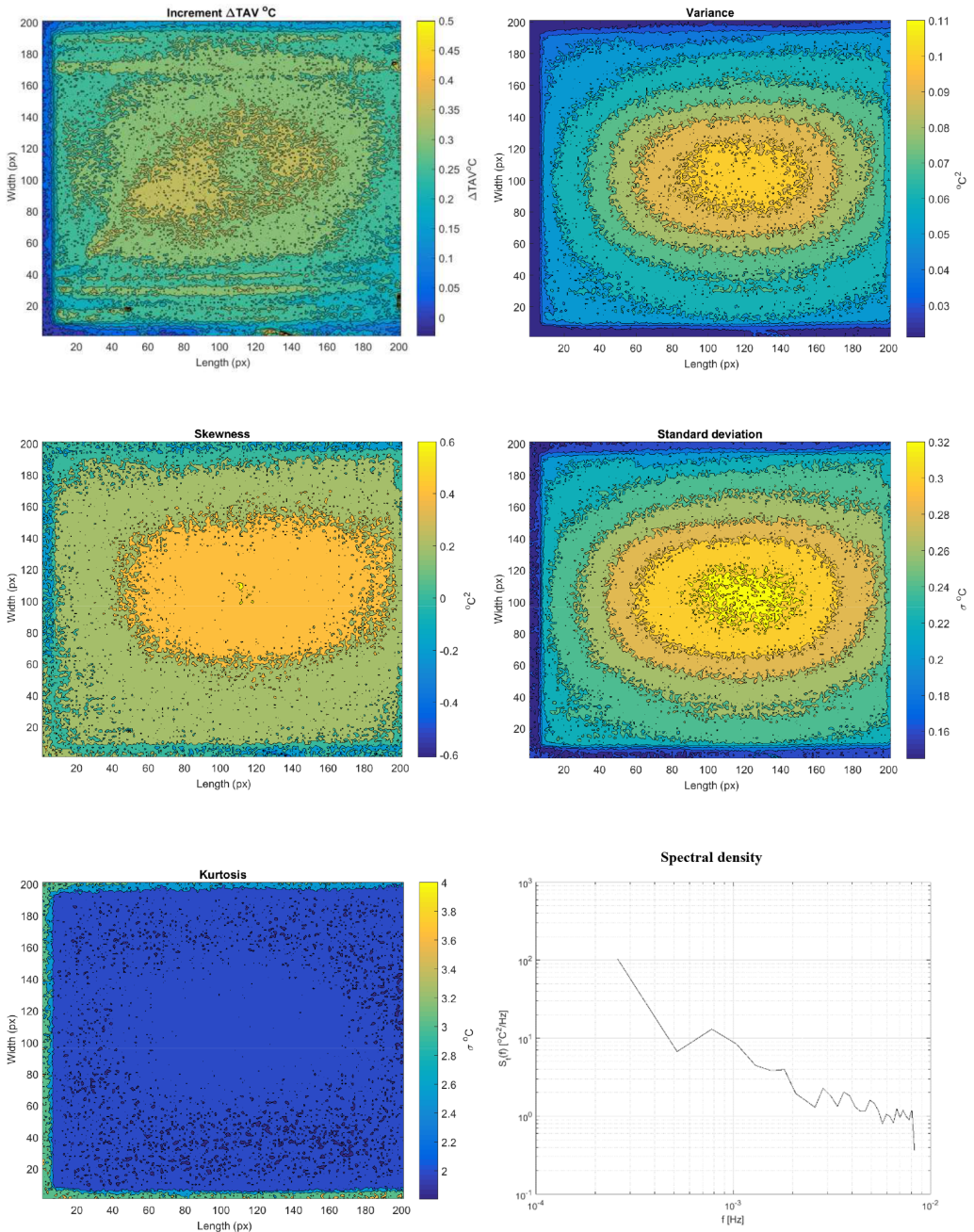

Fig. 8. Changes in the determined statistical parameters for the electrochemical capacitor specimen P2 ($I = 306$ mA and $U = 2.7$ V) for an interval between 25 and 100 min (see Fig. 7).

Figure 9, though, shows statistical parameters calculated for a time interval when some distinct changes in the electrical parameters of the tested electrochemical capacitor were observed (a period between 100 and 160 min of testing specimen P2).

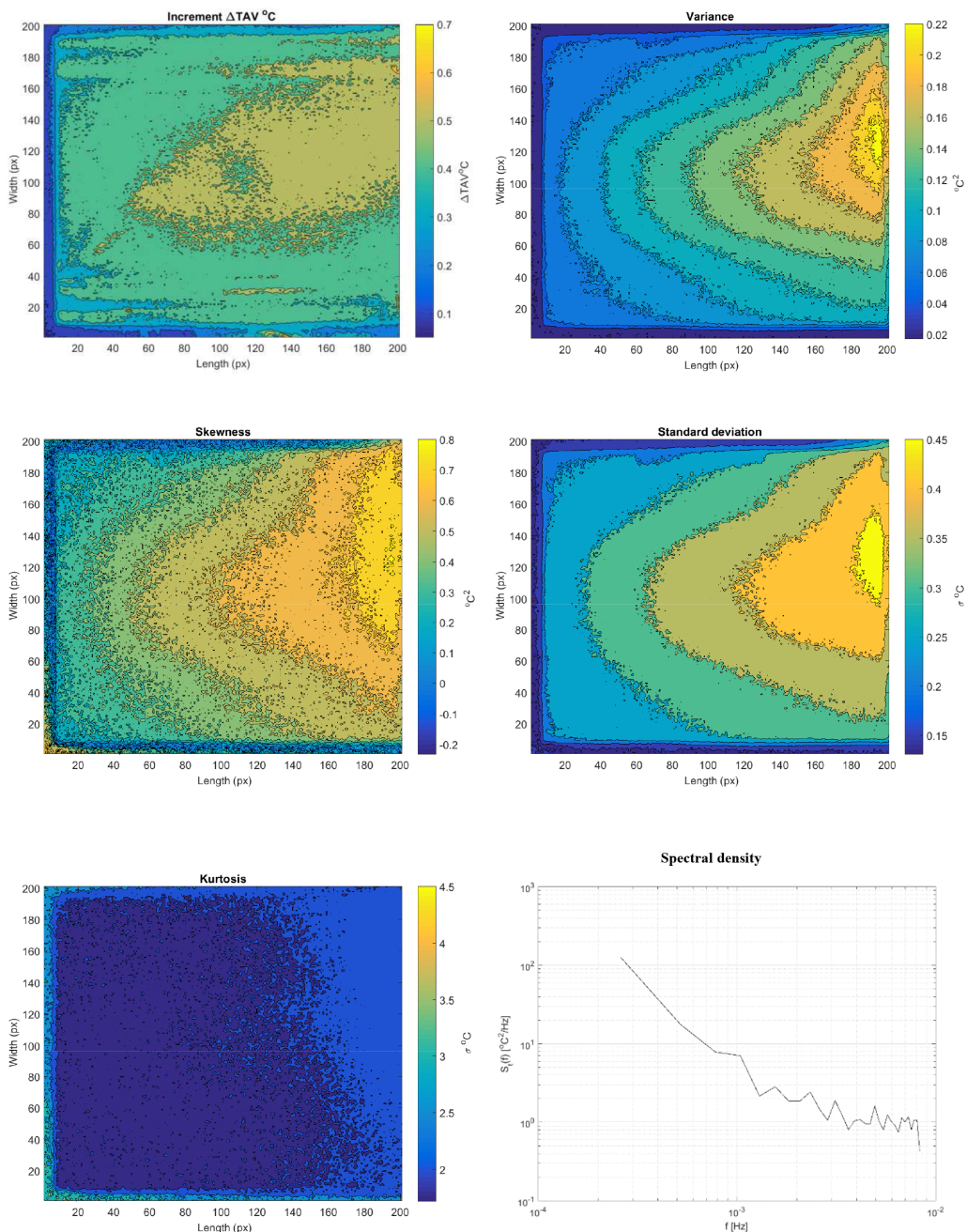

Fig. 9. Changes in the statistical parameters for the electrochemical capacitor specimen P2 ($I = 306$ mA and $U = 2.7$ V) for an interval between 100 and 160 min (see Fig. 7).

Figure 10 shows parameters (C , ESR, ΔT_{MAX}) of the electrochemical capacitor specimen P3, when no change in its parameters occurred except for those beyond the permissible tolerance values (the tested specimen P3 was non-degraded in accordance with the previously presented criteria). The tested specimen P3 was subjected to the long-term measurement. The tests were carried out with current values exceeding their rated value.

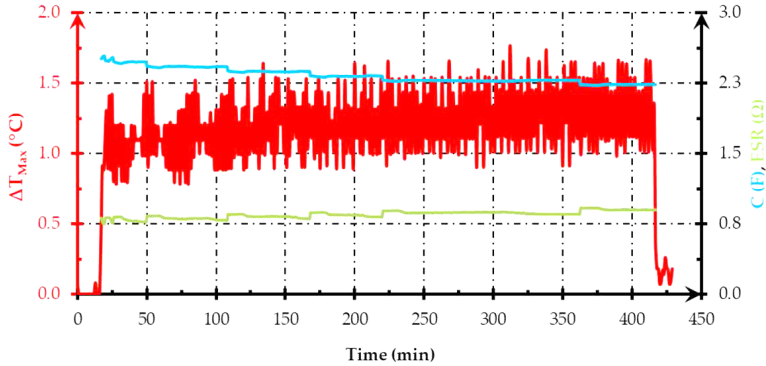

Fig. 10. Changes in maximum temperature increment (ΔT_{MAX}), capacitance (C) and equivalent series resistance (ESR) recorded during testing the electrochemical capacitor specimen P3 ($I = 420$ mA and $U = 3.6$ V), the specimen was not degraded.

Only after more than 25,000 cycles of charging/discharging the ESR value occurred to be out of the accepted criterion (an increase of 100% in relation to the initial value). Changes of parameters (C , ESR and ΔT_{MAX}) for specimen P3 are shown in Fig. 11.

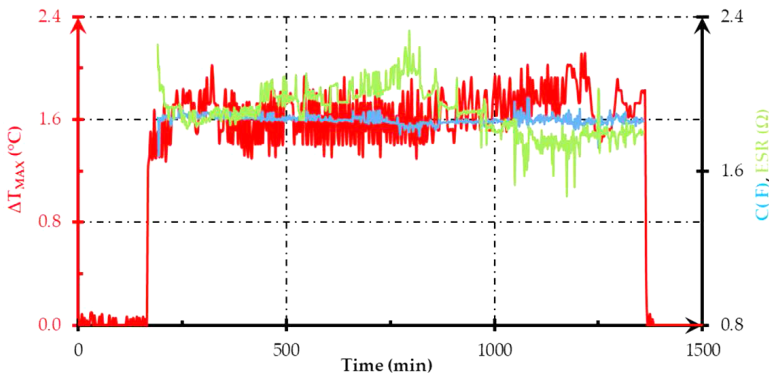

Fig. 11. Changes in maximum temperature increment (ΔT_{MAX}), capacitance (C) and equivalent series resistance (ESR) recorded during testing the electrochemical capacitor specimen P3 ($I = 420$ mA and $U = 3.6$ V); the specimen was degraded; ESR increased by over 100% compared with its initial value.

Figure 12 presents statistical parameters for a specimen which exhibits no degradation, while Fig. 13 shows a specimen that was degraded during the test.

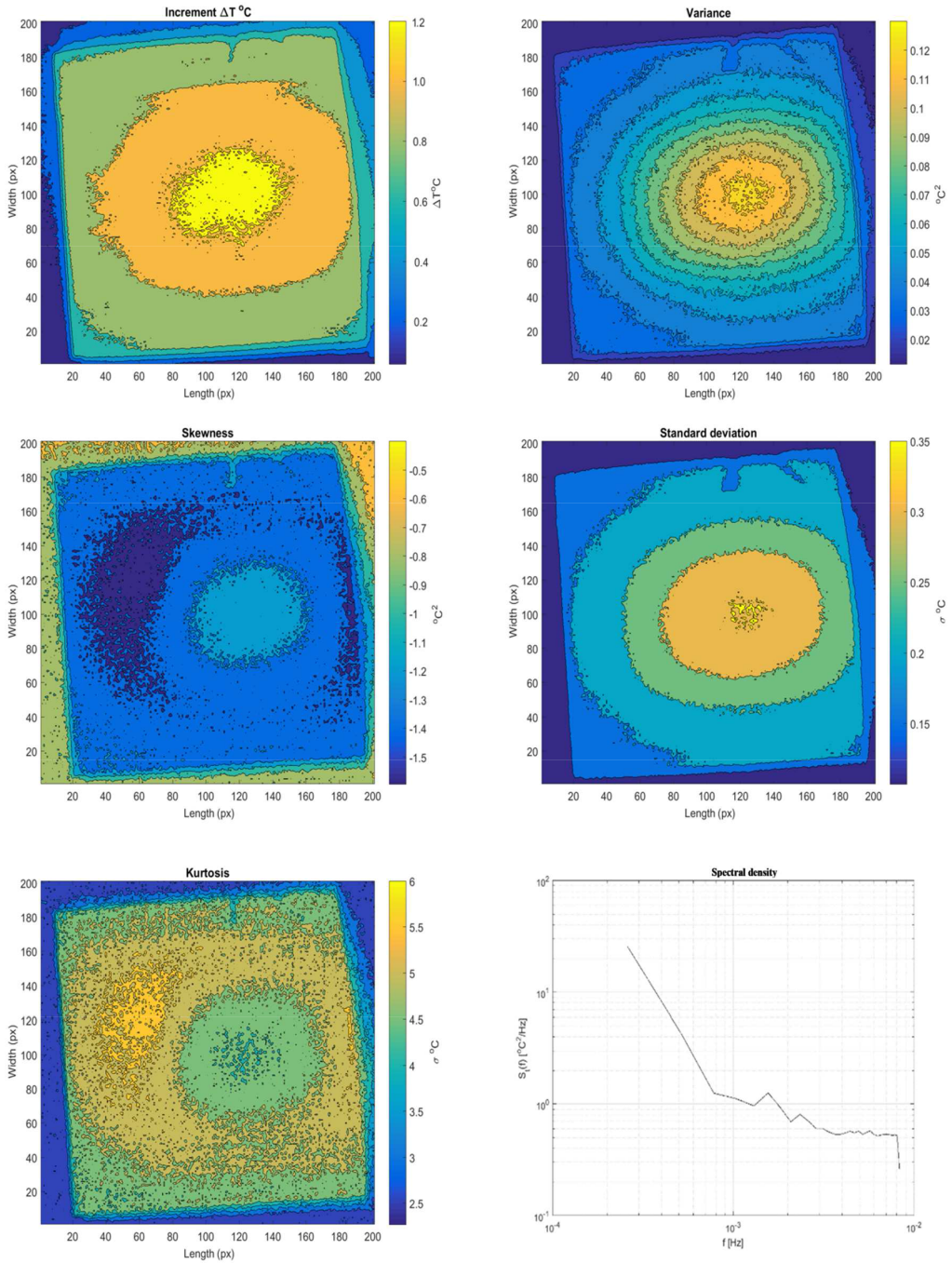

Fig. 12. Changes of statistical parameters recorded during testing the electrochemical capacitor specimen P3 ($I = 420$ mA and $U = 3.6$ V), when the specimen was not degraded.

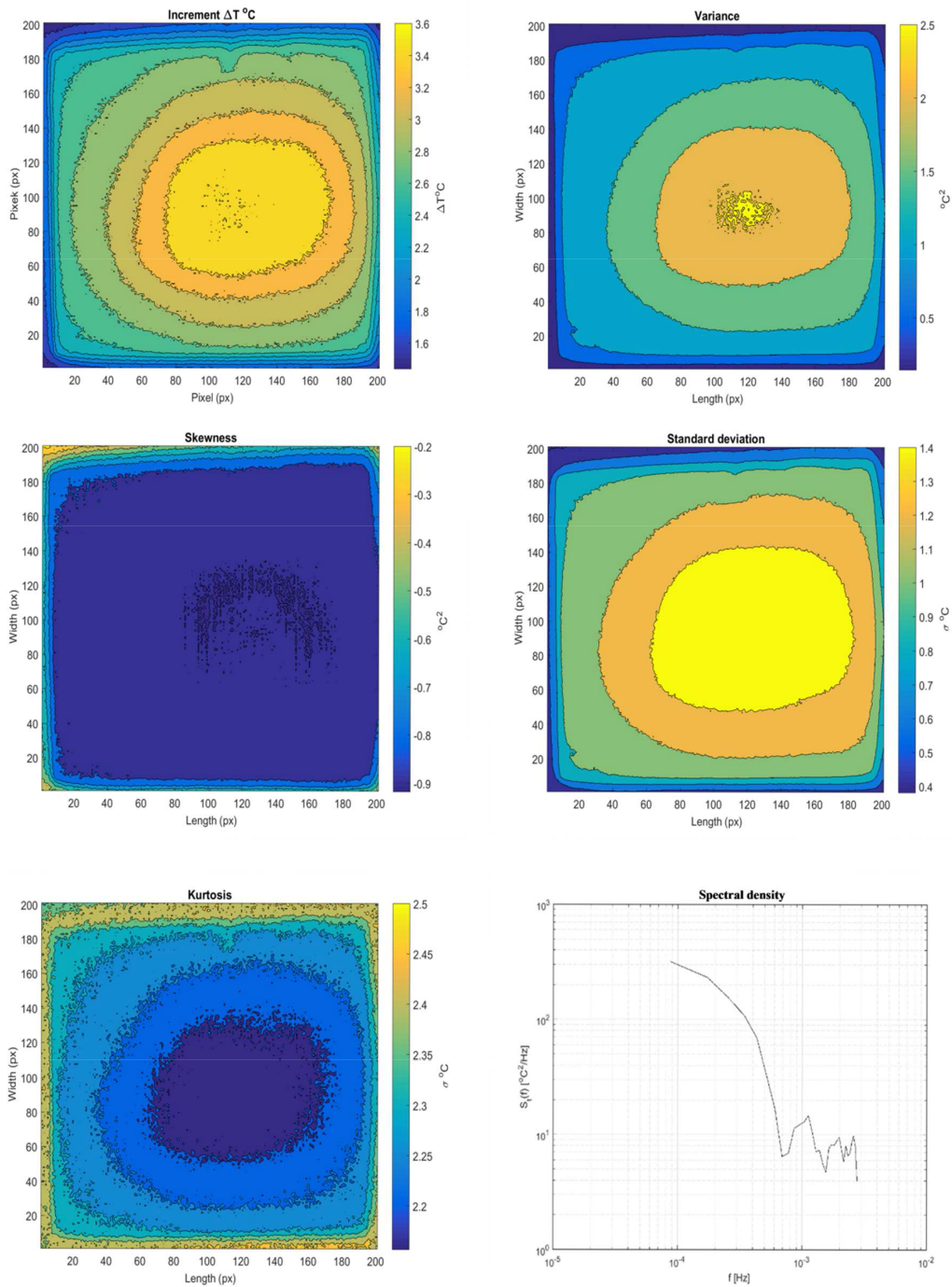

Fig. 13. Changes of statistical parameters recorded during testing the electrochemical capacitor specimen P3 ($I = 420$ mA and $U = 3.6$ V), when the specimen was degraded (ESR increased by over 100% compared with its initial value).

5. Conclusions

The observed fluctuations of temperature of an electrochemical capacitor are at least of dual nature. On one hand, they constitute disturbances that mask the occurrence of an object in relation to the parameter under consideration. This is clearly illustrated by the picture shown in Fig. 5 indicating only the occurrence of fluctuation of the parameter describing changes in the temperature field (variance) and its complete masking. The only information obtained from this drawing is the conclusion that it is in balance with the environment (it is indistinguishable from the background). On the other hand, if the fluctuations exceed a certain level, they enable the object to be observed much more clearly, by means of some statistical parameters, than in the case of classic thermographic images resulting from determination of *e.g.* temperature increments (*e.g.* Figs. 12a and 13a). At the same time, it can be observed that, for example, imaging using standard deviation or variance clearly identifies areas in which there are changes in the distribution of the temperature field.

On the basis of the presented examples, general conclusions, regarding the use of thermal imaging of the tested specimens, can be expressed by the use of such statistical parameters as *e.g.* variance or standard deviation. The determined statistical parameters enable more accurate characterization of a tested specimen by:

- a) isolation of the tested object from the background even in the case of small changes in the temperature field;
- b) clear indication of areas in which there are changes in emission of the thermal energy.

They can be used to observe more closely the areas in which changes occur. Furthermore, the obtained values of statistical parameters shown in Fig. 12 and Fig. 13 in combination with those obtained with classic measurements (shown in Fig. 10 and Fig. 11) indicate that in the case of the tested specimen the change in basic parameters (C and ESR) is accompanied with a significant change in variance. The variance value changes from 0.1°C for a specimen in the non-degraded state (C of 2.4 F and ESR of 0.8 Ω) to a level of 2.5°C for a specimen in which degradation changes occur (C of 1.9 F and ESR of 2.0 Ω). At the same time, the examples presented in Fig. 8 and Fig. 9 show that changes in the distribution of statistical parameters on the observed surface indicate the degradation processes occurring in the specimen. Unfortunately, at the present stage of research, there is no relation between the changes in spectral density of the examined area and the changes in values of basic parameters (C and ESR). To conclude, it can be stated that due to the occurrence of fluctuations in the temperature field, we can characterize and describe a given object in more detail.

Acknowledgements

This research was financed by the National Science Center, Poland, project No. DEC-2014/15/B/ST4/04957, “Charging/discharging mechanism at the electrode/electrolyte interface of supercapacitors”.

References

- [1] Szewczyk, A. (2017). Measurement of Noise in Supercapacitors. *Metrol. Meas. Syst.*, 24(4), 645–652.
- [2] Szewczyk, A., Sikula, J., Sedlakova, V., Majzner, J., Sedlak, P., Kuparowitz, T. (2016). Voltage Dependence of Supercapacitor Capacitance. *Metrol. Meas. Syst.*, 23(3), 345–358.

- [3] Pascot, C., Dandeville, Y., Scudeller, Y., Guillemet, P., Brousse, T. (2010). Calorimetric Measurement of the Heat Generated by a Double-Layer Capacitor Cell under Cycling. *Thermochemica Acta*, 510(1), 53–60.
- [4] Guillemet, P., Pascot, C., Scudeller, Y. (2008). Electro-Thermal Analysis of Electric Double-Layer-Capacitors. *2008 14th International Workshop on Thermal Investigation of ICs and Systems*, 224–228.
- [5] Vollmer, M., Mollmann, K.P. (2010). *Infrared Thermal Imaging: Fundamentals, Research and Applications*. John Wiley & Sons.
- [6] Živčák, J., Hudák, R., Madarász, L., Rudas, I.J. (2013). *Methodology, Models and Algorithms in Thermographic Diagnostics*. Springer Science & Business Media.
- [7] Diakides, M., Bronzino, J.D., Peterson, D.R. (2012). *Medical Infrared Imaging: Principles and Practices*. CRC Press.
- [8] Galla, S. (2017). A Thermographic Measurement Approach to Assess Supercapacitor Electrical Performances. *Applied Sciences*, 7(12), 1–14.
- [9] VIGOCam V50.Pdf. <https://www.vigo.com.pl/pub/File/PRODUKTY/Thermal-imaging-system/v50.pdf> (Jan. 2018).
- [10] Graphite 33.Pdf. <https://www.vigo.com.pl/pub/File/PRODUKTY/Thermal-imaging-system/v50.pdf> (Jan. 2018).
- [11] Minkina, W., Dudzik, S. (2009). *Infrared Thermography: Errors and Uncertainties*. John Wiley & Sons.
- [12] Stanger, L.R., Wilkes, T.C., Boone, N.A., McGonigle, A.J.S., Willmott, J.R., (2018). Thermal Imaging Metrology with a Smartphone Sensor. *Sensors*, 18(7), 1–5.
- [13] Béguin, F., Frackowiak, E. (2013). *Supercapacitors: Materials, Systems and Applications*. John Wiley & Sons.
- [14] Liang, J., Li, F., Cheng, H.M., Béguin, F. (2017). On Energy: Electrochemical Capacitors: Capacitance, Functionality, and Beyond. *Energy Storage Materials*, 9, A1–A3.

Journal version of the paper presented at the 8th International Conference on Unsolved Problems of Noise (UPoN-2018, chaired by Janusz Smulko), Gdańsk, Poland, 9–13 July 2018. The meeting was dedicated to the 70th birthday of Michael F. Shlesinger.