

Modelling of load-displacement curves obtained from scaffold components tests

E. BŁAZIK-BOROWA^{1*}, J. SZER², A. BOROWA¹, A. ROBAK¹, and M. PIENKO¹

¹Lublin University of Technology, Faculty of Civil Engineering and Architecture, Nadbystrzycka 40 str., 20-618 Lublin, Poland

²Lodz University of Technology, Faculty of Civil Engineering, Al. Politechniki 6, 00-637 Lodz, Poland

Abstract. The paper presents the modelling measurement results of the load-displacement relation for scaffold stands and bracings. In the case of stands, there are two sections of curves, i.e. a straight-line and curvilinear section, and in the case of bracings, two straight line sections as well as one curvilinear section are distinguished. As a result of analyses, it is concluded that the sections which can be approximated by means of linear functions should be distinguished in graphs, if possible. On the one hand, this results from the evaluation methods of scaffold components. Nevertheless, the determination of elastic-linear scope of components' operation is useful in engineering practice during computer calculations. Moreover, the method of determining an intersection point between functions, approximating tests results, along with analysis of the impact of polynomial degree, approximating the research results, on the time and effectiveness of the process of approximating functions selection, are all demonstrated in this article. The proposed method can prove useful in all science fields where curves obtained from any research (laboratory test, in situ test, numerical analysis) require approximation or replacement with a simpler description.

Key words: scaffolds, correlation functions, approximation of measurement results, elasticity.

1. Introduction

Civil engineering is the field of science in which problem solutions require knowledge of many basic sciences such as mathematics, physics and chemistry. Paper [1] presents the multi-faceted nature of construction and claims that long-term observation of buildings or any type of tests (laboratory test, in-situ test, numerical analysis) allow to develop relations useful in engineering practice, known as rules of thumb. However, as noted in paper [2], the development of rules of thumb must be based on thorough analysis of phenomena as because of simplifications they can lead to incorrect conclusions.

The operation of scaffolds and the provisions regarding safety of their users are conditioned upon factors such as, among others, technology solutions applied to the production of individual components, the quality of production and assembly, shape of full scaffolding as well as appropriate determination of scaffold effort. Significance of the above-mentioned factors is proved by the fact that scaffolds need to comply with European requirements and standards [3–5]. It is also confirmed by the research presented in literature, which concerns the analysis of load bearing capacity of scaffold nodes [6, 7], geometrical and material imperfections [8, 9], research on scaffold stability [10–12], etc. Scaffold components are controlled, e.g. by tests which determine load-displacement curves and bearing capacity of components, taking account of the technology and quality of production. Subsequently, the results of measurements are subjected to statistical analysis whose effects have a considerable

impact on the manner of numerical modelling of scaffolds and, consequently, on the results of internal forces calculations and structure effort. These problems have been described, among others, in papers [13–16]. The results of static-strength calculations of modular scaffolds of complicated structure with different types of stand-ledger nodes, e.g. pinned nodes, which are susceptible and stiff, are compared in paper [16]. The influence of imperfections and second-order effects are taken into account in calculations. It is demonstrated that the values of stresses in stands and ledgers differ from each other even by 100% when various methods of nodes modelling are applied. Paper [13] concerns the approach to selecting the characteristics of nodes' work in scaffolds, described as the relation between the node load and appropriate displacement, as well as the influence of these characteristics on internal forces in components. The same author described the impact of imperfection models and the work of scaffold nodes, determined on the basis of research, on the selection of numerical methods and on the duration of calculations in paper [14]. The measurements of the moment-rotation relation for nodes of pipe scaffolds and approximation of measurements results by different function sets are described in paper [15]. There, the authors performed computer calculations to verify which set of approximating functions yields the best results and, finally, they concluded that in the first part of the graph, the best solution is to apply a straight line, representing a looseness, and in the other part, to apply two subsequent linear functions. The problem of impact of nodes' susceptibility on scaffolds load bearing capacity combined with research on the subject of nodes and approximation of test results is the topic of papers [17–20]. A considerable influence of the approximation method used for test results of nodes on the outcomes of static-strength calculations of scaffolds is demonstrated in the above-mentioned papers.

*e-mail: e.blazik@pollub.pl

Manuscript submitted 2018-04-26, revised 2018-07-19, initially accepted for publication 2018-08-25, published in April 2019.

Papers [13–15] referred to the research on nodes susceptibility. Meanwhile, laboratory tests, as per European standards, shall be performed in reference to elements such as: ledgers, stands, bracings, consoles, stand-ledger nodes at different types of loads and a stand-bracing node. Tests can be conducted at a single cycle of loading or at several cycles of loading, however, in the second case, the bracket of measurement results shall be determined. In reference to the curves obtained in such a manner, one should determine the set of functions which describe research results with the greatest possible correlation and enable the determination of work nature of a given element as well as limit calculation load bearing capacity.

This article presents an example of connections between research problems and engineering practice. It shows that it is possible to develop models that can be treated as rules of thumb thanks to scientific research based on such basic fields as mathematics and physics and usage of computer science. Methods for approximation of curves which are the result of measurements are also presented in the paper. This is done on the example of modeling of load-displacement curves obtained from scaffolding elements tests. This type of elements is chosen because as the load increases, changes can be seen in the behavior of the system. They lead to change in the character of the analyzed curves. In the case of this type of problems, both the determination of the set of function equations is necessary and the points of transition between them. This problem was particularly focused on in the article.

On the basis of selected tests of scaffold components, this paper presents: the analysis of the impact of polynomial degree, approximating the research results, on the time and effectiveness of the process of approximating functions and selection of the method for determining an intersection point between functions. This is preceded by a description of the tests and their results along with necessary information on scaffolding tests and their assumptions. During the research, an own program under the name of Nebelung, enabling statistical analysis of measurement results in line with European standard EN 12811-3 [5], is used.

2. Test description

Research on the possibility of curves selection, approximating the results of tests, was performed in reference to scaffold stands and bracings. The components consist of aluminum pipes and steel heads. Stands are made of pipes of 48.3 mm in diameter and wall thickness of 4 mm, and bracings are made of a rectangular pipe of the dimensions of 48.3×34 mm as well as wall thickness of 4 mm. The tests were performed with the use of a Zwick testing machine at the Civil Engineering Laboratory of Lublin University of Technology.

The study of load bearing capacity of stands consisted in measuring vertical force F , applied to a stand, and displacement u (Fig. 1a). During this process, vertical displacement of the crosshead, which is simultaneously the displacement of the loaded end of the stand, was measured. Vertical load was applied to the upper end of the stand.

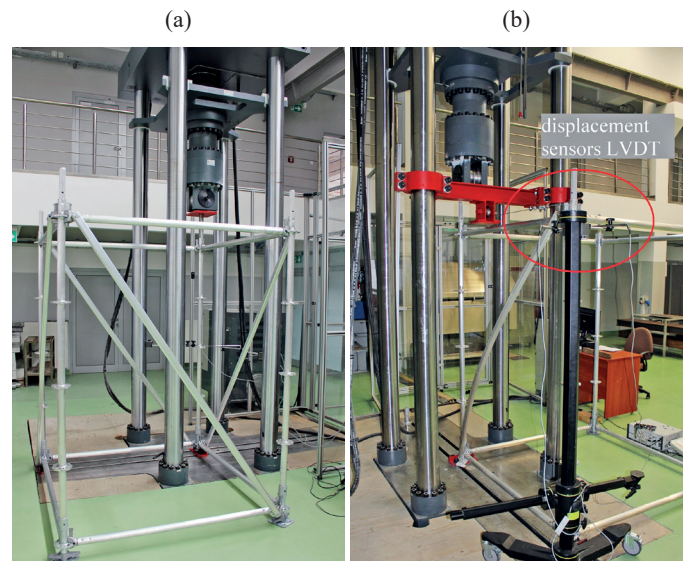

Fig. 1. System for testing load-bearing capacity of: a) scaffold stands, b) bracings

The research on the load bearing capacity of bracing consisted in applying horizontal force to the system whose view is shown in Fig. 1b. Loading was applied with the use of a steel rope. Since the rope stretched, additional displacement sensors LVDT were used, located directly at a loaded node, measuring two horizontal component displacements, which were mutually perpendicular. The resultant value from both sensors was assumed as u displacement for the purpose of analysis. A bearing, fixed stiffly to the load-bearing components of the press machine, was used to excite horizontal load. The bearing changed the direction of loading from vertical at crosshead F_{zwick} to a horizontal one applied to the F node (Fig. 2). The values of F forces were determined on the basis of following formula:

$$F = \frac{F_{zwick}}{\sin(\alpha)}, \quad (1)$$

where $\sin(\alpha)$ is determined from the formulae below:

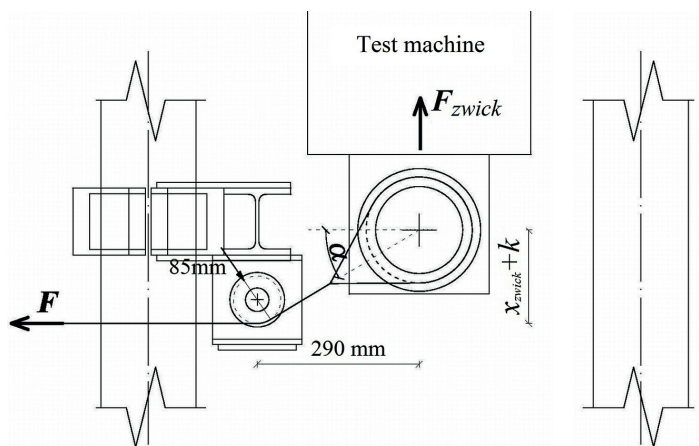

Fig. 2. The diagram of steel wire fixing to a machine crosshead

$$\frac{x_{zwick} + k}{290 \text{ mm} - \frac{85 \text{ mm}}{2} \frac{\tan(\alpha)}{\sqrt{1 + \tan^2(\alpha)}}} = \tan(\alpha), \quad (2)$$

$$\left\{ \begin{array}{l} \sin^2(\alpha) + \cos^2(\alpha) = 1 \\ \tan(\alpha) = \frac{\sin(\alpha)}{\cos(\alpha)} \end{array} \right\} \Rightarrow \sin(\alpha) = \frac{\tan(\alpha)}{\sqrt{1 + \tan^2(\alpha)}}, \quad (3)$$

where: x_{zwick} – displacement of press crosshead, $k = 127.5 \text{ mm}$ for the distance between stands equals 3.072 m , and $k = 167.5 \text{ mm}$ for the rest of scaffolds sets (cf. Fig. 2).

In the case of both tests, the increase of loading was controlled by displacements and it stood at 5 mm/min . The system was loaded to about 200 N , then it was unloaded and loaded once again in the relevant measurement. The measurements were carried out for five stands as well as five bracings. The results from relevant measurements are shown in Fig. 3.

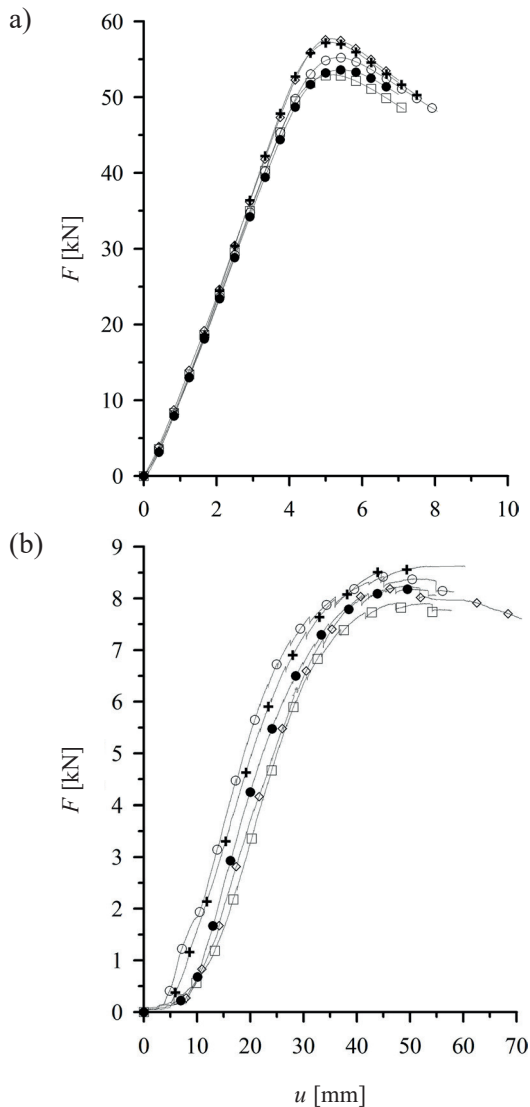

Fig. 3. Load-displacement curves obtained in tests for: a) stand; b) bracing

3. Approximation of research results

3.1. Presentation of assumptions. The aims and assumptions of analysis are presented prior to the analysis of sample results of measurements. The outcomes of measurements are load F – displacement u relations and the main component of analysis is the approximation of these curves by the set of functions so that the correlation between measurement results and individual functions is the greatest possible and meets the requirement $\rho^2 \geq 0,95$, where ρ^2 – Pearson correlation coefficient determined from the following formula:

$$\rho = \frac{\sum_{i=1}^n (F_i - \bar{F})(f_i - \bar{f})}{\sqrt{\sum_{i=1}^n (F_i - \bar{F})^2 \sum_{i=1}^n (f_i - \bar{f})^2}}, \quad (4)$$

where: F_i – result of measurement for value u_i , \bar{F} – average value of measurement result from the range of (u_1, u_n) , f_i – value of function for abscissa w_i , \bar{f} – average value of function from the range of (u_1, u_n) .

The possibilities of function sets selection from the mathematical point of view are described e.g. in paper [13]. However, in this paper, the selection of function is based on the assumption that it is necessary to determine the part of the curve which can be approximated by a linear function, describing linear-elastic work of a scaffold component. The need to determine the linear part results from the fact that standard EN 12811-3 [5] imposes the restrictions referring to the determination of load value, at which it can be stated that the scaffold component no longer withstands the impact applied by the test press. Maximum loading F_C , obtained in the measurement (point C in Fig. 4a), is treated mainly as the maximum value of loading. However, standard EN 12811-3 [5] recommends also the verification of load value F_A , at which the quotient of plastic energy E_p to elastic energy E_s is $q_e = E_p/E_s = 11$. The values of plastic energy E_p and elastic energy E_s are determined as areas under the load F – displacement u curves, as shown in Fig. 4b.

Nevertheless, the assumption that within this range, a scaffold component works in the linear-elastic range, yet primarily an elastic one, is necessary to determine load F_B at which limited plastic deformations u_{pl_cr} (i.e. damage) occur. In the case of scaffolds, due to multiple use of components, damage that is unrepairable cannot be acceptable. The use of a straight line, describing the linear part, to determine point B in the load F – displacement u graph, that is the value of load F_B , is shown in Fig. 4a.

Research experience shows that these three values of F_A , F_B and F_C frequently need to be supplemented by other points in the curve, since the assumption of what the maximum load-bearing capacity means depends on the function which this element fulfills in a scaffold. The values of the parameter, defined as a 5% quantile of logarithm normal distribution of values F at the level of confidence of 75% (cf. standard EN 12811-3 [5]), can eventually be determined for particular points, and the minimum value among all the obtained ones for points A, B and C is assumed as the permitted characteristic value $F_{k,b}$.

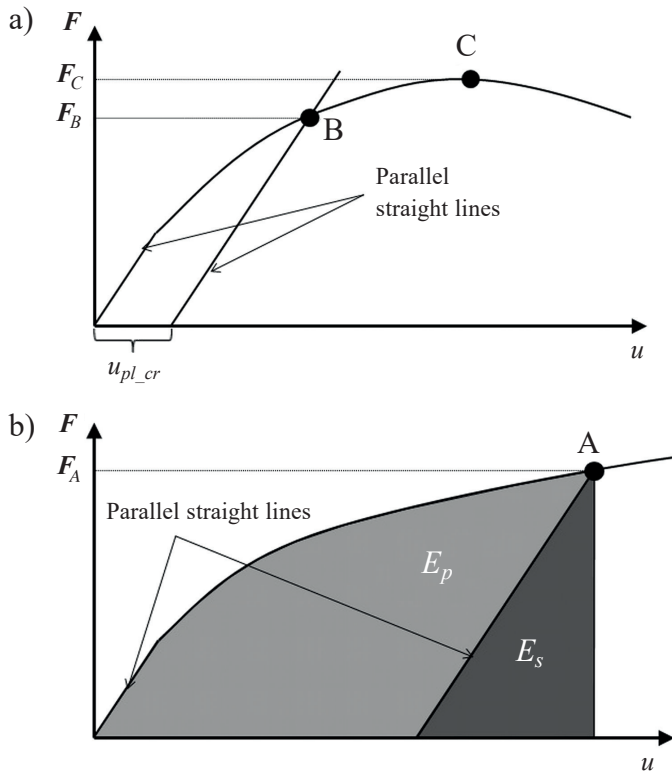

Fig. 4. Location of points defining load-bearing capacity of a component

Further decrease of value of the component limit load, limiting the possibility of plasticity occurrence, consists in applying the following formula:

$$F_{k,nom} = \frac{F_{k,b}}{\gamma_{R2}}, \quad (5)$$

where

$$1.25 \geq \gamma_{R2} = -0.025\bar{q}_e + 1.275 \geq 1.00. \quad (6)$$

And the last decrease of the permissible load value consists in considering partial safety coefficients according to the formula below:

$$F_{sp} = \frac{F_{k,nom}}{\gamma_M \gamma_F}, \quad (7)$$

where $\gamma_M = 1.1$ and $\gamma_F = 1.5$ are partial coefficients.

A detailed method for determining limit calculation values of the component load is contained in standard EN 12811-3 [5] and in [21]. Meanwhile, (5) and (6) are shown in this paper in order to demonstrate that the approach to approximate measurement results is significant also while determining load bearing capacity of components, and primarily while determining parameter q_e where the approximation of a portion of research results by a linear function is essential.

As it can be observed from the above problem, the linear function shall also be included in the set of functions approx-

imating the test results for scaffold components. Subsequent assumptions are as follows:

- on the load-displacement curve, a fragment can be determined which can be approximated by means of a straight line,
- on the load-displacement curve, there are fragments which can be approximated by means of polynomial of n -degree, described by the following formula:

$$F = \sum_{i=0}^n a_i u^i, \quad (8)$$

- individual approximating functions shall be selected so as to obtain possibly the greatest correlation with the results of measurements, and thus the values of correlation coefficients ρ^2 for particular approximating functions,
- the degree of applied polynomials shall possibly be the least since the increase of polynomial degree of approximating functions does not increase the accuracy of approximation, yet it lengthens the calculation time, which is confirmed by the analyses presented in this paper.

The introduction of these assumptions is shown in the following points on two selected examples, i.e. on the results of measurements of force-displacement relations for stands and bracings.

3.2. Selection of curves for tests of load-bearing capacity of stands.

The selection of functions approximating measurement results is preceded by the analysis of graph shape with the indication of which parts can be separated. As it can be seen in Fig. 3a, there is one linear and one curvilinear part. The degree of polynomial, approximating the curvilinear part, was selected following analysis of the impact of polynomial degree on the time of calculation performance (Fig. 5) as well as on the average value of the square of correlation coefficient (Fig. 6), determined from the following formula:

$$\overline{\rho^2} = \frac{1}{U} \int_U (\rho(u))^2 du, \quad (9)$$

where: U – range of deflection measurements, $\rho(u)$ – value of correlation between test results and a polynomial when the transition point of intersection between a straight line and polynomial has got abscissa u .

As it can be seen in Fig. 5 and Fig. 6, the higher the degree of polynomial, the longer the calculations whose aim is to determine the set of functions approximating measurement results. On the other hand, Fig. 6 shows that the average value of correlation coefficient square at a polynomial degree of 4 is similar to the value of this coefficient at higher degrees of polynomial. There can only be one conclusion, i.e. that the curvilinear part of a graph shall be approximated by the polynomial degree of 4.

Another stage of analysis is selection of the point at which a straight line ends and a polynomial starts. It is assumed that the values $\rho_p^2(u)$ (for a straight line) and $\rho_w^2(u)$ (for a polynomial) at this point shall assume possibly the highest values. For this purpose, the analysis of changes in values of the following functions was carried out:

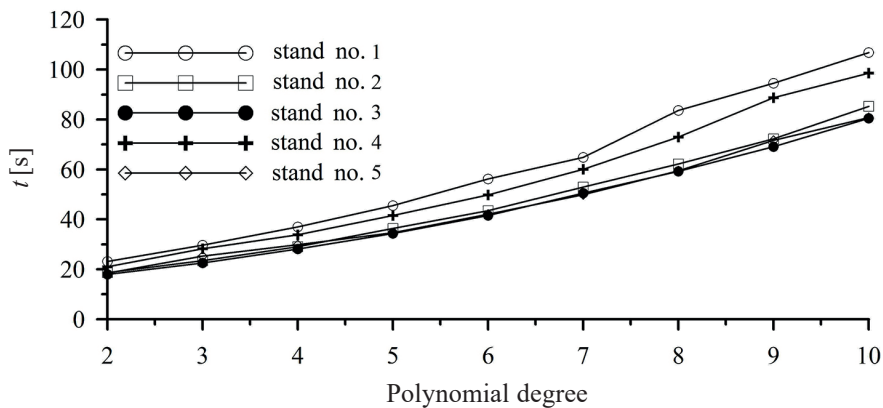

Fig. 5. Relation of calculation time and polynomial degree approximating nonlinear part of measurements in the tests on stands

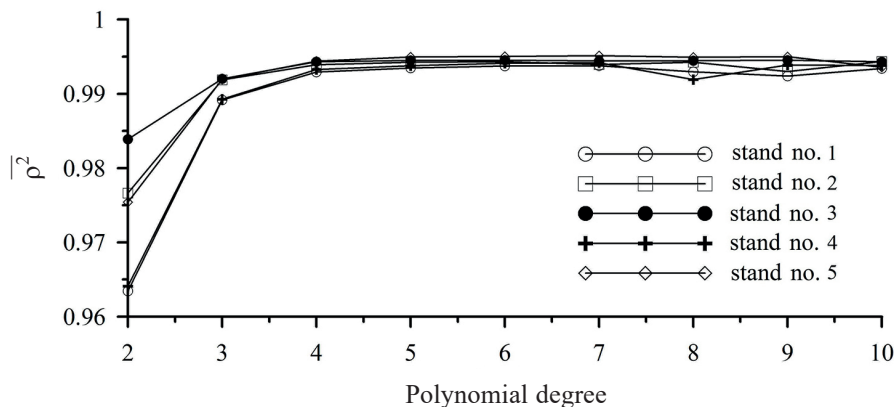

Fig. 6. Relation of average value of correlation and the polynomial degree approximating nonlinear part of measurements in the tests on stands

$$g_1(u) = \rho_p^2(u) + \rho_w^2(u), \quad (10)$$

$$g_2(u) = \rho_p^2(u)\rho_w^2(u), \quad (11)$$

$$g_3(u) = 2 \frac{\rho_p^2(u)\rho_w^2(u)}{\rho_p^2(u) + \rho_w^2(u)}, \quad (12)$$

The last of the functions was developed by the authors in analogy to the formula used for research on statistic hypothesis.

For functions $g_1(u)$, $g_2(u)$ and $g_3(u)$, local maxima were determined and their abscissae are recommended to be the first coordinates of the transition point between a straight line and polynomial approximating measurement results. Figure 7 shows sample sets of graphs of correlation coefficients squares as well

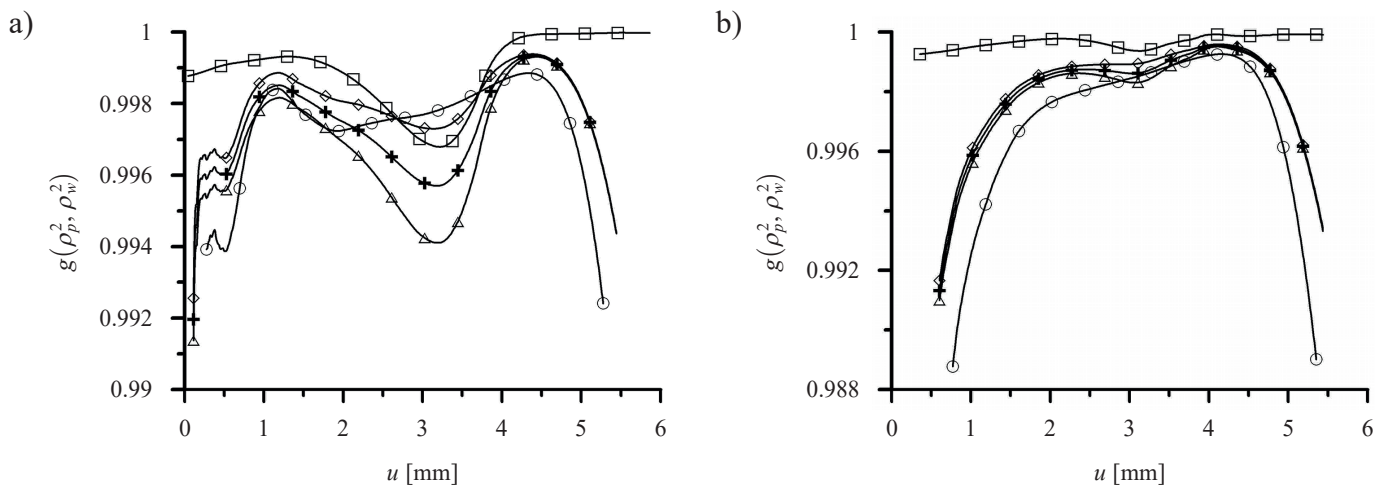

Fig. 7. Set of graphs: $\circ - \rho_p^2(u)$, $\square - \rho_w^2(u)$, $\diamond - g_1(u)/2$, $\triangle - g_2(u)$, $+$ $- g_3(u)$: a) for stand No. 1, b) for stand No. 3

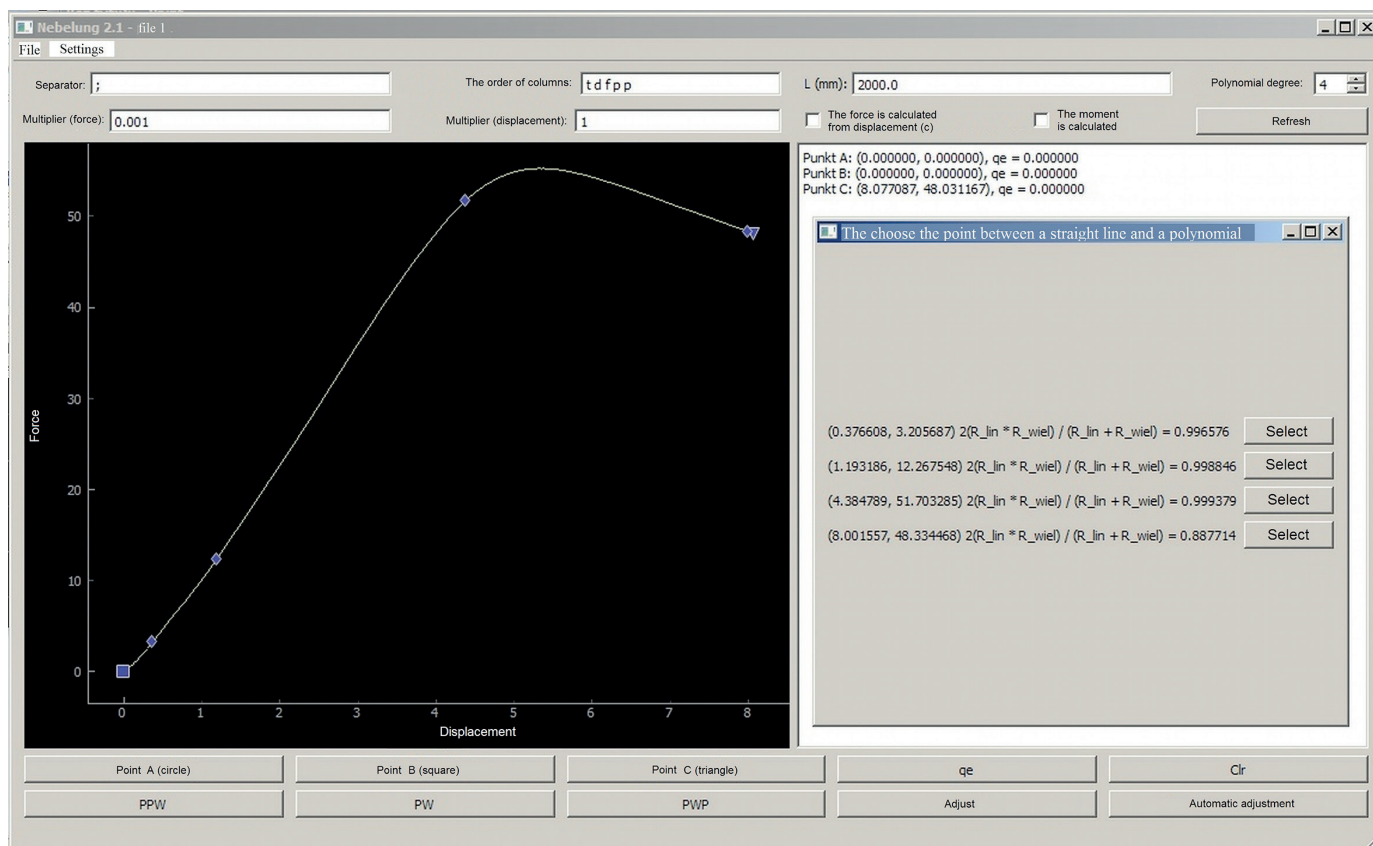

Fig. 8. Screenshot on the basis of tests on stand No. 1 with points which correspond to maxima in the graph of function $g_3(u)$

as functions $g_1(u)$, $g_2(u)$ and $g_3(u)$, while Fig. 8 demonstrates a screenshot with marked points which correspond to subsequent local maxima for function $g_3(u)$, and Table 2 summarizes the coordinates of points at which local maxima and their values are stated. As it is shown in Table 1, the values of displacements u , at which local maxima of particular functions were obtained, are close to each other. Hence, Fig. 8 shows only one selected result of Nebelung program operation. The points at which the maximum values of functions $g_1(u)$, $g_2(u)$ and $g_3(u)$ were obtained are also close to each other.

As it results from the analysis of Fig. 7, Fig. 8 and Table 1, the point of abscissa $u = 4.38$ mm shall be selected as the point between a straight line and polynomial, since the optimum values of correlation coefficients of both graph parts were obtained for this point. Obviously, such a thorough analysis does not need to be performed for individual results. On the basis of this analysis, it is clear that the results recommended by the program, on the grounds of function $g_3(u)$, are reliable. Table 2 shows the results of function selection for five test trials conducted for an aluminum stand, which were selected with the use of this function.

In the case of tests on a stand, only point C (Fig. 4a) was possible to be determined. Its coordinates determined the specified permissible load of a stand. Particular values which referred to these calculations are compiled in Table 3. The calculated, permissible compressive force of a stand $F = 24.21$ kN is ob-

Table 1
Local maxima of functions $g_1(u)$, $g_2(u)$ and $g_3(u)$

Function	u [mm]	F [kN]	$\rho_p^2(u)$	$\rho_w^2(u)$	$\frac{g_1(u)}{2}$	$g_2(u)$	$g_3(u)$
$g_1(u)$	0.3766	3.2057	0.9945	0.9990	0.9967		
	1.1932	12.2675	0.9984	0.9993	0.9989		
	4.3931	51.7731	0.9988	0.9999	0.9994		
	7.6432	49.4160	0.8396	0.9998	0.9197		
$g_2(u)$	0.3766	3.2057	0.9945	0.9990		0.9957	
	1.1932	12.2675	0.9984	0.9993		0.9982	
	4.3848	51.7033	0.9988	0.9999		0.9993	
	7.6432	49.4160	0.8396	0.9998			
$g_3(u)$	0.3766	3.2057	0.9945	0.9990			0.9962
	1.1932	12.2675	0.9984	0.9993			0.9985
	4.3848	51.7033	0.9988	0.9999			0.9994
	7.6432	49.4160	0.8396	0.9998			0.9196

tained as the final value. The point of this ordinate falls within the range of system linear work, which in engineering practice means that a scaffold shall be designed so that a normal force in a stand from real loads would not be greater than $F = 24.21$ kN and during computer calculations of scaffold effort, the material of stands can be modelled by linear relation σ - ϵ .

Table 2
Juxtaposition of functions approximating measurement results

No.	Straight line equation	Transition point u [mm]	Polynomial equation
1	$F = 12.46 u - 1.91;$ $\rho^2 = 0.9988;$	4.38	$F = -0.14 u^4 + 3.98 u^3 - 42.86 u^2 + 201.51 u - 292.39;$ $\rho^2 = 0.9999$
2	$F = 12.52 u - 1.77;$ $\rho^2 = 0.9992$	4.11	$F = -0.12 u^4 + 3.45 u^3 - 35.8 u^2 + 163.49 u - 220.65;$ $\rho^2 = 0.9999$
3	$F = 12.35 u - 2.02;$ $\rho^2 = 0.9993$	4.12	$F = -0.09 u^4 + 2.59 u^3 - 28.69 u^2 + 138.97 u - 193.00;$ $\rho^2 = 0.9999$
4	$F = 13.30 u - 2.67;$ $\rho^2 = 0.9982$	4.43	$F = -0.22 u^4 + 5.93 u^3 - 60.66 u^2 + 271.06 u - 387.85;$ $\rho^2 = 0.9999$
5	$F = 12.96 u - 1.71$ $\rho^2 = 0.9991$	4.45	$F = -0.33 u^4 + 8.65 u^3 - 85.55 u^2 + 371.84 u - 539.63;$ $\rho^2 = 0.9999$

Table 3
Determination of the specified permissible calculation load on a stand according to [5]

No.	F_C [kN]	q_e	$F_{k, b}$ [kN]	\bar{q}_e	γ_{R2}	$F_{k, nom}$ [kN]	F_{sp} [kN]
1	54.18	1.1647	49.7112	1.2243	1.2444	39.9482	24.2110
2	52.87	1.2940					
3	53.72	1.3290					
4	56.25	1.1346					
5	57.05	1.1994					

3.3. Selection of curves for tests of load-bearing capacity of bracings. The results of load bearing capacity measurements at compression are shown in Fig. 3b. This example concerns tests on a bracing mounted in the field of 2.0 m × 1.572 m. The following parts are seen at every curve representing subsequent measurements:

- the graph part which is responsible for looseness in a bracing connection to rosette, and which can be interpolated by a linear equation,

- the graph part which can be approximated by a linear equation,
- the graph part which shall be approximated by a polynomial.

Before commencing the process to determine approximating functions, the polynomial degree, describing the third one among approximating functions, shall be defined. The relation of the average value of correlation coefficient square, described by (9), and a polynomial degree was verified in the case of bracings similarly as in the case of stands. The result of such calculation is shown in Fig. 9, on the basis of which

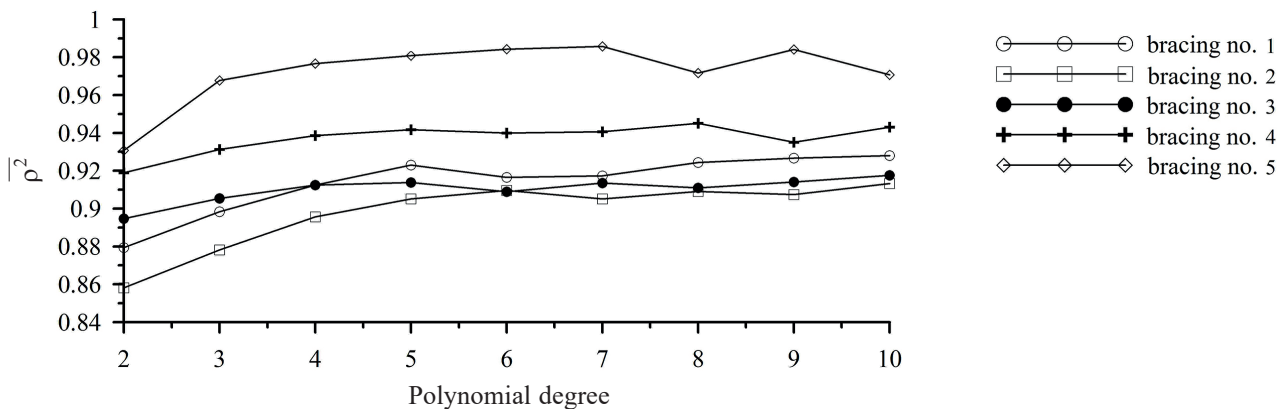

Fig. 9. Relation of average correlation value and polynomial degree approximating the nonlinear part of measurements

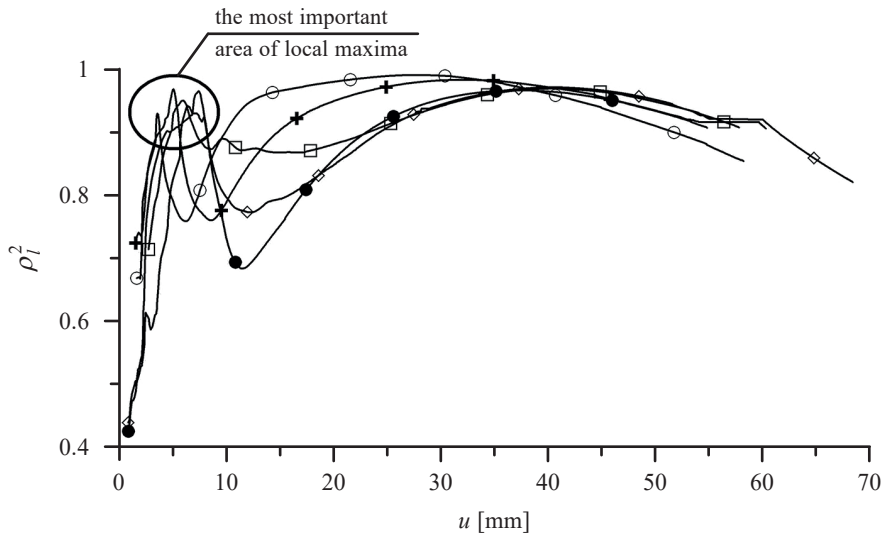

Fig. 10. Graphs of correlation coefficients square $\rho_1^2(u)$, markings as in Fig. 9

it is evident that the third part of calculation results can be approximated by a polynomial of 4th or 5th degree. It was decided to approximate it by the 4th degree polynomial, since the coefficient of approximating polynomial at the expression u^5 is small enough, in comparison with the remaining coefficients of the polynomial, so that this part of the polynomial does not influence final results of statistical analyses.

The procedure of load-displacement curve approximation in the Nebelung program is the following:

- determination of correlation coefficient square $\rho_1^2(u)$ between points lying on the first straight line and measurements results (Fig. 10),
- determination of local maxima of functions $\rho_1^2(u)$,

- selection of the point at which the first straight line ends, on the basis of local maxima and the graph shape from measurements,
- determination of value $\rho_p^2(u)$ (for the second straight line) and $\rho_w^2(u)$ (for a polynomial) as well as one of the functions $g_1(u)$, $g_2(u)$ and $g_3(u)$, a sample set of all the functions is shown in Fig. 11,
- determination of local maxima of one selected function, in this case function $g_3(u)$,
- selection of a point between the parts of research results, approximated by another linear function and a polynomial, on the basis of local maxima and the graph shape from measurements.

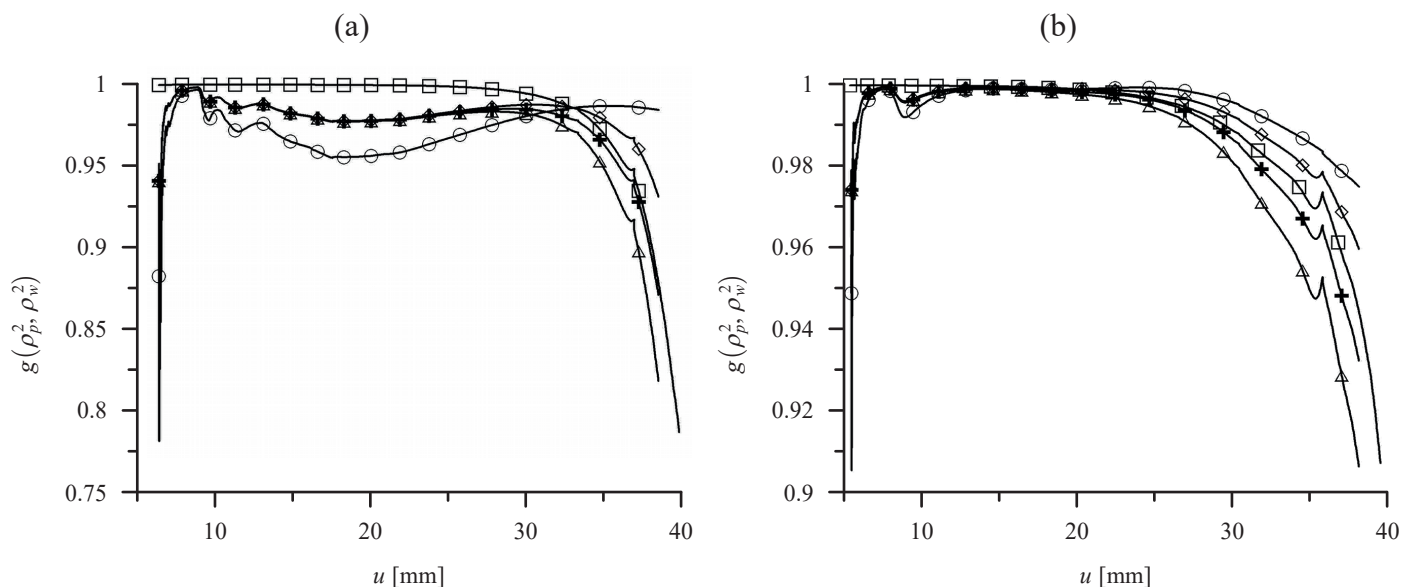

Fig. 11. Functions set at the approximation of third part of curve from research by a polynomial of 4th degree: $\circ - \rho_p^2(u)$, $\square - \rho_w^2(u)$, $\diamond - g_1(u)/2$, $\triangle - g_2(u)$, $+$ - $g_3(u)$: a) for bracing No. 2, b) for bracing No. 4

Table 4
Functions approximating load-displacement curves

	First straight line equation	Trans. point u [mm]	Second straight line equation	Trans. point u [mm]	Polynomial equation
1	$F = 0.0394u + 0.0139$; $\rho^2 = 0.9279$	3.99	$F = 0.32u - 1.20$; $\rho^2 = 0.9990$	20.67	$F = -0.000004u^4 + 0.000719u^3 + -0.0487u^2 + 1.54u + -11.12$; $\rho^2 = 0.9970$
2	$F = 0.0290u + 0.0123$; $\rho^2 = 0.9497$	6.34	$F = 0.28u - 2.27$; $\rho^2 = 0.9819$	30.71	$F = -0.000002u^4 + 0.000452u^3 + -0.0392u^2 + 1.56u + -15.75$; $\rho^2 = 0.9933$
3	$F = 0.0258u + 0.0061$; $\rho^2 = 0.9230$	8.25	$F = 0.35u - 2.84$; $\rho^2 = 0.9982$	22.79	$F = 0.000041u^3 + 0.0112u^2 + 0.72u + -6.00$; $\rho^2 = 0.9994$
4	$F = 0.0352u + 0.0202$; $\rho^2 = 0.9676$	5.43	$F = 0.31u - 1.53$; $\rho^2 = 0.9990$	15.96	$F = -0.000001u^4 + 0.000189u^3 + -0.0198u^2 + 0.91u + -6.65$; $\rho^2 = 0.9994$
5	$F = 0.0249u + 0.0158$; $\rho^2 = 0.9649$	7.74	$F = 0.30u - 2.40$; $\rho^2 = 0.9934$	25.46	$F = -0.000001u^4 + 0.000265u^3 + -0.0289u^2 + 1.34u + -14.06$; $\rho^2 = 0.9954$

The results of approximation according to the above procedure are compiled in Table 4. Figure 12 shows a sample result of approximation in the form of a graph. This figure also demonstrates the location of points B and C. Point B is determined on the basis of the second straight line as well as the assumption that $u_{cr} = L/500$, where L is the element's length. Determination of this would not be possible if the other part of the curve from research was approximated by a different type of function.

It shall also be pointed out that the correlation coefficient for the first straight line, which approximates the part responsible for the looseness in connections, is smaller than for other areas. This is due to the initial nature of system operation, which is subjected to inaccuracies and differences in the assembly of particular sets as well as possibly to the disturbances of entire system operation during testing before particular parts match each other.

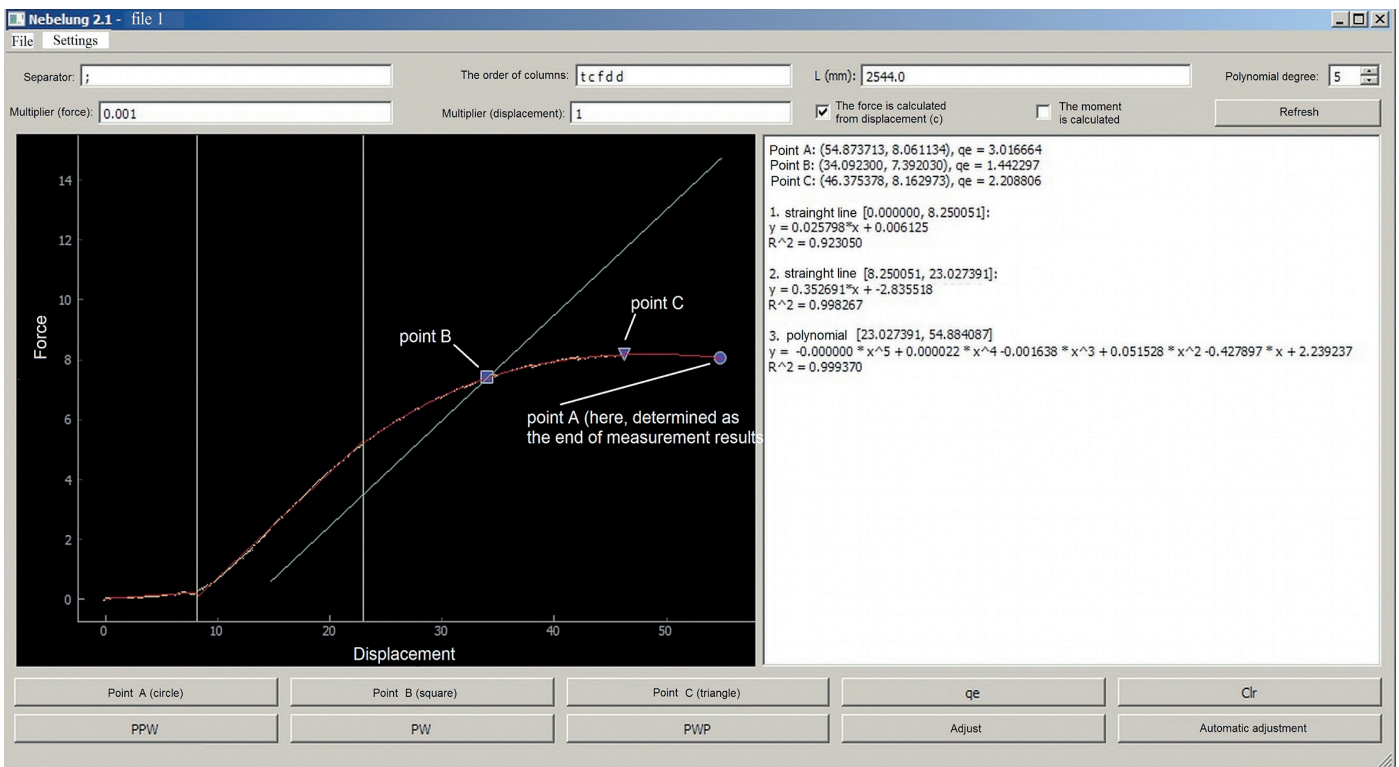

Fig. 12. Result of measurements approximation as well as location of points A, B and C for bracing No. 3

Table 5
Determination of specified permissible calculation load according to standard [5]

	F_C [kN]	F_B [kN]	q_e	$F_{k,b}$ [kN]	\bar{q}_e	γ_{R2}	$F_{k,nom}$ [kN]	F_{sp} [kN]
1	8.32	7.7570	1.4035	7.6773	1.3957	1.2401	6.1908	3.7520
2	7.84	7.5946	1.3647					
3	8.16	7.3802	1.4436					
4	8.60	7.8803	1.3937					
5	8.18	7.8396	1.3728					

Table 5 compiles the tests results and parameters essential to determine the permissible value of stand load. As in the case of a stand, calculated value $F = 3.75$ kN for a bracing falls within a linear scope of bracing operation. Yet, in this case it should be noted that there is a looseness in the stand-bracing connection, described by the first straight line, and that the slope of the other one is considerably lower than the one resulting from the formula below:

$$\frac{F}{u} = \frac{EA}{L} \cos(\beta), \quad (13)$$

which would be real provided that a bracing assumed a compressive force. The following markings were used in formula (12): $E = 7 \cdot 10^7$ kPa – Young’s modulus, $A = 4.76 \cdot 10^{-4}$ m² – cross-sectional area, β – angle between a ledger and bracing.

The expression F/u , determined from (13), is 8.094 kN/mm and coefficients at u in the equation of the second straight line equal about 0.3 kN/mm. This results from the fact that the operation of a set is not dependent on the resistance of a bracing’s main part, which is a pipe. This operation is conditioned upon the stiffness of the bracing-stand connection and a construction solution applied to connect the pipe with the head. Hence, a material of a component itself can be modelled as a linear-elastic one, whereas the model of a bracing-stand connection should take a looseness and connection susceptibility into account.

4. Conclusions

The paper presents research methods that allow to obtain reliable models describing measurement results. The models consist of a set of functions, selected so as to obtain the greatest possible correlation between the test results and model functions. Moreover, it is highly crucial that the models can be used in engineering practice. From the very beginning of this paper, it is stated that it is necessary to distinguish the part of research results which is considered to describe a linear-elastic nature of component operation. The straight line equation, approximating this part of research results, is needed to determine parameter q_e and potentially point B (Fig. 4a). Moreover, in engineering practice, designing the construction of scaffolds

is substantially simplified by the application of linear-elastic material models.

In reference to the tests of scaffolds components, the sets of functions, approximating measurements results, as well as permissible loads of components were determined. The procedure used for this is mainly based on the recommendations of standard [5]. The authors proposed the approach of determining the degree of polynomials and ranges in which particular approximating functions are selected. All three functions of correlation coefficients $g_1(u)$, $g_2(u)$ and $g_3(u)$ demonstrate local maxima for similar values, and thus all of them can be used for the selection of intersection points for scaffold tests. For other research, the function $g_3(u)$ can prove more useful. It should be recalled that the authors developed this function in analogy to the formula used for research on statistic hypothesis. Function $g_3(u)$ has no defect which can occur for other functions. For function $g_1(u)$ errors can result from properties of summation and for function $g_2(u)$ they originate from the properties of multiplication.

Finally, the proposed method can be useful in all fields of science where curves obtained from any research (laboratory test, in situ test, numerical analysis) require approximation or replacement with a simpler description. However, independently from the applied methods and fields of science, while performing research of this type, it is crucial to analyze the measurement results visually and to compare them with already known laws of physics in order to describe the operation of a system in a proper manner.

Acknowledgements. This work was financially supported by the statutory budget funds of the Faculty of Civil Engineering and Architecture of the Lublin University of Technology and of the Faculty of Civil Engineering of the Lodz University of Technology.

REFERENCES

- [1] L. Czarnecki and D. Van Gemert, “Scientific basis and rules of thumb in civil engineering: conflict or harmony?”, *Bull. Pol. Ac.: Tech* 64 (4), 665–673 (2016).
- [2] L. Czarnecki and J.J. Sokołowska, “Material model and revealing the truth”, *Bull. Pol. Ac.: Tech* 63 (1), 7–14 (2016).
- [3] EN 12810–2 2010 Facade scaffolds made of prefabricated components – Part 2: Particular methods of structural design.

- [4] EN 12811-1 2007 Temporary works equipment – Part 1: Scaffolds – Performance requirements and general design.
- [5] EN 12811-3 2003 Temporary works equipment – Part 3: Load testing.
- [6] M. Pieńko and E. Błazik-Borowa, “Numerical analysis of load-bearing capacity of modular scaffolding nodes”, *Eng. Structure* 48, 1–9 (2013).
- [7] L. Jia, H. Liu, Z. Chen, Q. Liu, and S. Wen, “Mechanical properties of right-angle couplers in steel tube–coupler scaffolds”, *J. of Constructional Steel Research* 125, 43–60 (2016).
- [8] J.L. Peng, S.L. Chan, and C.L. Wu, “Effects of geometrical shape and incremental loads on scaffold systems”, *J. of Constr. Steel Research* 63, 448–459 (2007).
- [9] E. Błazik-Borowa and J. Gontarz, “The influence of the dimension and configuration of geometric imperfections on the static strength of a typical façade scaffolding”, *Arch. of Civil and Mech. Eng.* 16, 269–28 (2016).
- [10] J.-L. Peng, C.-W. Wu, S.-L. Chan, and C.-H. Huang “Experimental and numerical studies of practical system scaffolds”, *J. of Constr. Steel Research* 91, 64–75 (2013).
- [11] W.K. Yu, K.F. Chung, and S.L. Chan, “Structural instability of multi-storey door-type modular steel scaffolds”, *Eng. Structures* 26, 867–881 (2004).
- [12] L.B. Weesner and H.L. Jones, “Experimental and analytical capacity of frame scaffolding”, *Eng. Structures* 23, 592–599 (2001).
- [13] A. Misztela, “Modeling the load characteristics for connections in scaffolds”, *Przegląd Mechaniczny* 5, 19–26 (2011).
- [14] A. Misztela, “Influence of process parameters on the results of numerical analysis of nonlinear computational scaffolding International”, *J. of Applied Mech. and Eng.* 17 (3), 931–940 (2012).
- [15] U. Prabhakaran, R.G. Beale, and M.H.R. Godley, “Analysis of scaffolds with connections containing looseness”, *Comp. and Structures* 89 1944–1955 (2011).
- [16] E. Błazik-Borowa, A. Robak, and M. Pieńko, “The numerical analysis of the modular scaffold structure with the non-typical form”, *J. of Civil Eng., Environment and Architecture* 58 (3/11/II), 333–340 (2011).
- [17] H. Liu, Q. Zhao, X. Wang, T. Zhou, D. Wang, J. Liu, and Z. Chen, “Experimental and analytical studies on the stability of structural steel tube and coupler scaffolds without X-bracing”, *Eng. Structures* 32, 1003–1015 (2010).
- [18] T. Chandrangu and K.J.R. Rasmussen, “Structural modelling of support scaffold systems”, *J. Constr. Steel Research* 67, 866–875 (2011).
- [19] H. Zhang, T. Chandrangu, and K.J.R. Rasmussen, “Probabilistic study of the strength of steel scaffold systems”, *Structural Safety* 32, 393–401 (2010).
- [20] H. Liu, L. Jia, S. Wen, Q. Liu, G. Wang, and Z. Chen, “Experimental and theoretical studies on the stability of steel tube–coupler scaffolds with different connection joints”, *Eng. Structures* 106, 80–95 (2016).
- [21] E. Błazik-Borowa, M. Pieńko, A. Robak, A. Borowa, and P. Jamińska-Gadomska, “Analysis of ledger-stand joints in the aluminum modular scaffold”, *Arch. of Civ. Eng.* 63 (1), 17–31 (2017).