

ALEKSANDER KAROLCZUK *

THE PROBABILISTIC MODEL OF FATIGUE LIFE ESTIMATION FOR STRUCTURAL ELEMENTS WITH HETEROGENEOUS STRESS DISTRIBUTION

The paper presents the method of determination of two-dimensional probability distribution P_f of crack initiation versus fatigue life N and the fatigue damage parameter : $P_f - N - \sigma$. The proposed distribution P_f uses parameters of the standard fatigue characteristics and allows calculating fatigue life of elements with heterogeneous stress fields at any probability level. The model was successfully verified on experimental test results.

1. Introduction

Many machine elements work under variable loadings, which can cause the element damage and the machine failure. In order to avoid such undesirable events, many researchers investigate fatigue of materials, and they formulate algorithms allowing estimating fatigue life of structural elements.

Non-uniform stress fields are common in machine elements, and their presence makes calculations of fatigue life more difficult. Complicated shapes of the elements and ways of their loading cause formation of areas with different stresses and, in a consequence, with different levels of fatigue effort. From the experimental results it appears that fatigue life of such elements cannot be determined from the maximum local stresses [1, 2].

In the existing literature, we can find two groups of methods including influence of the stress gradient on fatigue life. One of them includes deterministic methods where fatigue life is determined without defining fatigue life scatters. In this group, the dominating methods reduce the stress field to local stresses by averaging [2]. The other group includes probabilistic meth-

* *Department of Mechanics and Machine Design Opole University of Technology, a.karolczuk@po.opole.pl*

ods assuming that: (i) the material contains various defects, (ii) the fatigue crack starts from the most harmful defect, i.e. the defect where morphology and stress level around the defect are conducive to the crack development [3-6]. According to these assumptions, size of the area subject to variable stresses influences probability of the crack occurrence.

In this paper, the author presents a probabilistic model of fatigue life estimation related to constructional elements, using the weakest link concept [3-6]. Contrary to the conventional determination of probability distribution of fatigue strength for a given fatigue life (a number of cycles to failure), the model presented in this paper insists on determination of the probability that the fatigue life N is less than a certain specific life N_i . Such approach allows determining fatigue life for any probability level. The Weibull probability distributions were used for calculations; their parameters were dependent on local equivalent stresses.

The presented approach includes the influence of both stress gradients and the element size on fatigue life. The model was verified by comparison of its results with the experimental results.

2. The tests

Cruciform specimens made of 18G2A (Fig. 1) with holes as stress concentrators were subjected to tests.

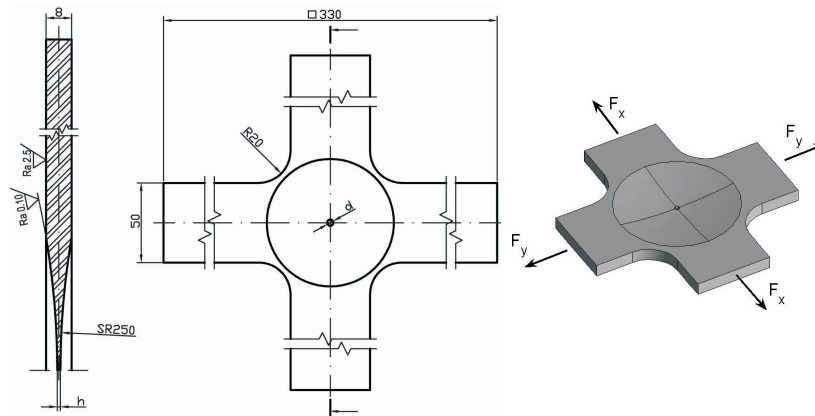

Fig. 1. (a) Geometry of a cruciform specimen, (b) scheme of specimen loading

Cyclic properties of the tested steel, i.e. relation between the number of cycles to failure N_f and the stress amplitude a as well as the parameters of the cyclic hardening curve ($\varepsilon_a^p - \sigma_a$) are given in Table 1. The tests were performed under the controlled force courses: $F_x(t) = F_{xa} \sin(2\pi ft)$, $F_y(t) = F_{ya} \sin(2\pi ft - \delta)$ with the same frequencies ($f = 13$ Hz) and similar

amplitudes of forces F_{xa} and F_{ya} with the phase shift $\delta = 180^\circ$ (Tab. 2). Table 2 also contains numbers of cycles to the crack initiation N_i corresponding to the crack length a_i and maximum (at the time domain t and geometry of the specimen) principal stress σ_1 calculated from the model of a body with kinematic hardening using the COMSOL program [7]. The cyclic hardening curve according to Ramberg-Osgood and the condition of plasticity according to the Huber-Mises-Hencky hypothesis were applied while calculations. A way of loading and geometry of specimens influenced a place where fatigue cracks occurred (Fig. 2). The crack length a_i assumed as the moment of crack initiation is the length of the first registered crack. The crack lengths were registered with an optical microscope (magnification 7 x) and a digital camera (0.0085 mm/pixel). More information about the tests can be found in [8].

Table 1.

Cyclic properties of 18G2A steel under alternating tension-compression

| $\sigma_a = \sigma_{af}(N_\sigma/N_f)^{1/m_\sigma}$ | | | $\varepsilon_a^p = (\sigma_a/K')^{1/n'}$ | |
|---|----------------|---------------------|--|----------|
| σ_{af} , MPa | m_σ , - | N_σ , cycles | K' , MPa | n' , - |
| 204 | 8.3 | $1.24 \cdot 10^6$ | 1323 | 0.207 |

Indices: af – fatigue limit, a – amplitude, p – plastic part

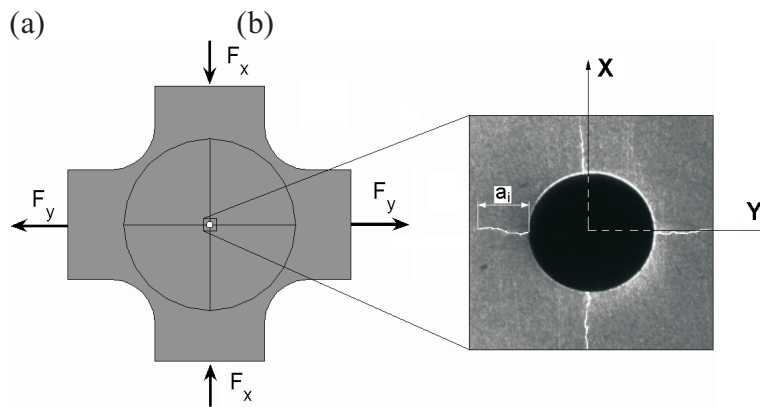

Fig. 2. Positions and orientation of fatigue cracks

Table 2.
 Characteristics of loading of cruciform specimens and numbers of cycles N_i to the fatigue crack of length a_i

| Specimen. | d, mm | h, mm | F_{xa} , kN | F_{ya} , kN | σ_1 , MPa | N_i , cycles | a_i , mm |
|-----------|-------|-------|---------------|---------------|------------------|----------------|------------|
| P02 | 3.0 | 1.40 | 13.30 | 13.10 | 366 | 39700 | 0.22 |
| P03 | 3.0 | 1.54 | 13.50 | 13.30 | 359 | 31100 | 0.37 |
| P04 | 3.0 | 1.86 | 13.55 | 13.30 | 344 | 60048 | 0.07 |
| P05 | 2.5 | 1.50 | 10.21 | 9.90 | 308 | 246695 | 0.25 |
| P07 | 3.0 | 1.75 | 11.20 | 10.80 | 318 | 140700 | 0.20 |
| P08 | 2.4 | 1.20 | 9.30 | 9.10 | 328 | 167050 | 0.10 |

3. The model

3.1. The classical Weibull theory

Probability distribution of the random variable elaborated by Weibull in 1939 [3] is widely applied in many fields. The distribution function was formulated after analyses of experiments concerning determination of static strength of brittle materials. The Weibull theory explains differences in the strength limits between tension and bending, and the scale effect. The conventional form of distribution of probability P_{mV} of element failure versus stress σ is expressed as

$$P_{mV} = 1 - e^{-\frac{1}{V_0} \int_v g(\sigma) dv}, \quad (1)$$

where V_0 is the so-called reference volume of the element characterized by distribution (1), and $g(\sigma)$ is the so-called function of failure risk, dependent on the material properties. Weibull proposed two forms of the function $g(\sigma)$, containing two or three parameters:

$$g(\sigma) = \left(\frac{\sigma - \sigma_0}{\sigma_u} \right)^m, \quad g(\sigma) = \left(\frac{\sigma}{\sigma_u} \right)^m, \quad (2)$$

where σ_0 , σ_u , m are the parameters of displacement, scale and shape of distribution, respectively (1). Because of different properties of the material on its surface and in its volume, Weibull considered separate determination of distribution of failure probability in the material volume (1) and on the free surface of the element.

In the case of non-uniform stress distribution in the material, the known parameters of the function (2) can be used for determination of failure probability (1) for a given element. Such an approach explains differences between

strengths of the materials subjected to tension and bending – in such cases stress distributions are different.

3.2. The Weibull theory concerning fatigue of materials

Weibull considered application of his theory in many fields. In [4], he analysed its implementation for fatigue processes. In such a case, distribution of failure probability is a two-dimensional function of stress σ and number of cycles N to failure of the element $P_f = f(\sigma, N)$. However, any form of such function has not been proposed. Other researchers [5,6] were developing this idea, but they concentrated on determination of the one-dimensional function $P_f = f(\sigma, N = \text{fatigue limit level})$, i.e. they tried to answer the question if the element undergoes failure or not.

3.3. The weakest link concept and two-dimensional distribution of fatigue failure probability

The foundations of the weakest link concept, being the base of the Weibull theory, were formulated in the twenties of the 20th century (see [9]). This chapter presents the weakest link concept and its application for formulation of the two-dimensional distribution of fatigue failure probability.

From the experiments it appears that for elements made of homogeneous materials loaded by a variable force $F(t)$ generating the homogeneous stress field with amplitude σ_a in the volume V of these elements, the logarithm of the number of cycles N to the crack initiation is a random variable with a determined probability density distribution p_f . According to the weakest link concept, let us assume that a given element of volume V or surface A includes various microdefects, statistically distributed. The crack initiation is going to occur in a certain elementary area (link) of the element, $V^{(i)}$, $A^{(i)}$, which contains the “most dangerous defect”. As for the next elements (specimens) of the same geometry (V, A) and loading $(F(t))$, “the most dangerous defect” exhibits other features, and the crack initiation occurs under another number of cycles N . In the case of heterogeneous stress field, the given element is divided into subdomains $V^{(i)}$ or $A^{(i)}$. The probability that a crack will not occur in the interval $[0, N]$ means that the crack initiation will not occur in any elementary subdomain (the weakest link concept). Let us assume that $P_e(A^{(i)})$ is the probability that the subdomain $A^{(i)}$ will not initiate a crack in a certain interval of the number of cycles $[0, N]$ and that for each subdomain the probabilities are independent. Then, the probability for all the element $P_e(A)$ is the product of probabilities $P_e(A^{(i)})$

$$P_e(A) = \prod_{i=1}^{i=k} P_e(A^{(i)}). \quad (3)$$

Crack initiation in the subdomain $A^{(i)}$ at a certain level of probability is a function of stress and life N . The following general form of this function is assumed:

$$P_f(A^{(i)}) = 1 - P_e(A^{(i)}) = 1 - e^{-\frac{1}{A_0} h(N, \sigma) A^{(i)}}, \quad (4)$$

where $h(N, \sigma)$ is a function dependent on a level of stress σ , at which we can observe scattering of a number of cycles to failure N ; A_0 is the reference surface. The probability of failure of a system including k subdomains is expressed by the following relationship

$$P_f(A) = 1 - P_e(A) = 1 - \prod_{i=1}^{i=k} P_e(A^{(i)}) = 1 - \prod_{i=1}^{i=k} e^{-\frac{1}{A_0} h(N, \sigma) A^{(i)}} = 1 - e^{-\sum_{i=1}^{i=k} \frac{1}{A_0} h(N, \sigma) A^{(i)}}. \quad (5)$$

Assuming $k \rightarrow \infty$, i.e. a continuous and homogeneous body, we can write Eq. (5) as

$$P_f(A) = 1 - e^{-\frac{1}{A_0} \int_A h(N, \sigma) dA}. \quad (6)$$

Eq. (6) is analogical to the Weibull equation (1), but in Eq. (6) the function of failure risk h is the function of two variables: σ and N . Since it is convenient to consider scatter of the fatigue life in the logarithmic scale, such a form of variable will be used in the expression for the function h . A general form of this function is analogical to the two-parameter Weibull function (2)

$$h(N, \sigma) = \left(\frac{\log(N)}{f(\sigma)} \right)^{m(\sigma)}. \quad (7)$$

Since scatters of the fatigue life N depend on the stress level, the parameters of shape and scale of distribution (6) become the stress functions. A fatigue characteristics, i.e. $\sigma_a - N_f$, joining the mean number of cycles N_f with the stress level σ_a can be used as the scaling function $f(\sigma = \sigma_a) = \log(N_f)$. The shape function $m(\sigma)$ is responsible for fatigue life scatter at a given level σ_a , so it can be expressed as the function $\log(N_f)$. Under high loadings, i.e. low life N_f , the scatters are smaller than under low loadings. Under a loading equal to the static strength limit, the fatigue life N_f does not exhibit any scatter ($N_f \rightarrow 1$ a loading cycle). On the other hand, under loadings at the level of the fatigue limit, some specimens are subjected to failure, and some

others have unlimited fatigue life, i.e. large scatters. From the simulations it appears that for the constant scaling function f the scatter decreases for the increasing function m . A simple function satisfying such requirements takes the following form

$$m(\sigma) = m(N_f) = \frac{p}{\log(N_f)}, \tag{8}$$

where p is the constant coefficient of distribution indicating a level of fatigue life scatter at the given level N_f . Finally, distribution of probability (6) of the element failure takes the form

$$P_f(A, N) = 1 - e^{-\frac{1}{A_0} \int_A \left(\frac{\log(N)}{\log(N_f)}\right)^{\frac{p}{\log(N_f)}} dA}. \tag{9}$$

In the case of uniform stress distribution of a free area A_0 , Eq.(9) reduces to

$$P_f(A) = 1 - e^{-\left(\frac{\log(N)}{\log(N_f)}\right)^{\frac{p}{\log(N_f)}}}. \tag{10}$$

Fig. 3 shows an exemplary, two-dimensional distribution of failure probability obtained from Eq. (10), using the fatigue characteristic ($\sigma_a - N_f$) of 18G2A steel (Tab. 1) under the assumption that $p = 100$.

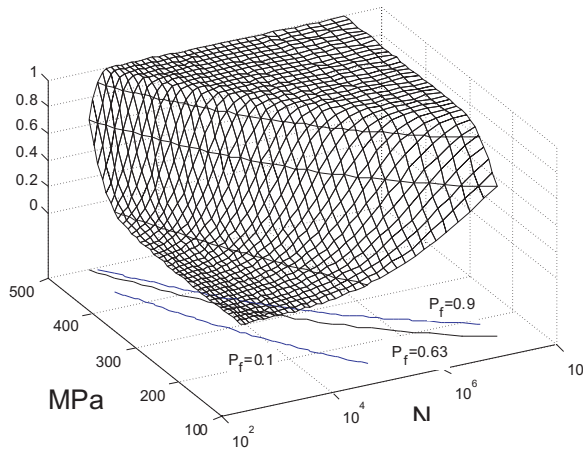

Fig. 3. Simulated two-dimensional distribution of the failure probability for the element made of 18G2A steel

Crossing the two-dimensional distribution $P_f(\sigma, N)$ by a horizontal plane, we obtain the fatigue characteristic $\sigma - N$ for any probability level. In the case of the distribution function according to Eq.(10), the basic characteristic $\sigma_a - N_f$ (Tab. 1) corresponds to probability $P_f = 0.63$ (for $N = N_f$).

4. Implementation of the two-dimensional probability distribution P_f in calculations of fatigue life

Let us assume that the cracks occurring on the free surface of the element are responsible for failure. If the parameters of two-dimensional probability distribution (10) are known, we determine fatigue life of the element with heterogeneous stress distribution according to the following procedure:

- (1) The free surface of the considered element is divided into subdomains $A^{(i)}$ of suitable size, with homogeneous stress distribution (Fig. 4a).
- (2) In each subdomain $A^{(i)}$, the multiaxial stress state $\sigma_{kl}^{(i)}(t)$ should be reduced to the equivalent state $\sigma_{eqa}^{(i)}$ with the use of a criterion of multiaxial fatigue.
- (3) The equivalent stress $\sigma_{eqa}^{(i)}$ and the fatigue characteristic $\sigma_a - N_f$ are used for calculations of a number of cycles to failure $N_f^{(i)}$ for each subdomain $A^{(i)}$ (Fig. 4b).
- (4) When the scaling function $\log(N_f^{(i)})$ is known, we determine the fatigue life distribution $P_e(A^{(i)}) = 1 - P_f(A^{(i)})$ (Fig. 4b)

$$P_e(A^{(i)}, N) = e^{-\frac{1}{A_0} \left(\frac{\log(N)}{\log(N_f^{(i)})} \right)^{\frac{p}{\log(N_f^{(i)})}} A^{(i)}} \quad (11)$$

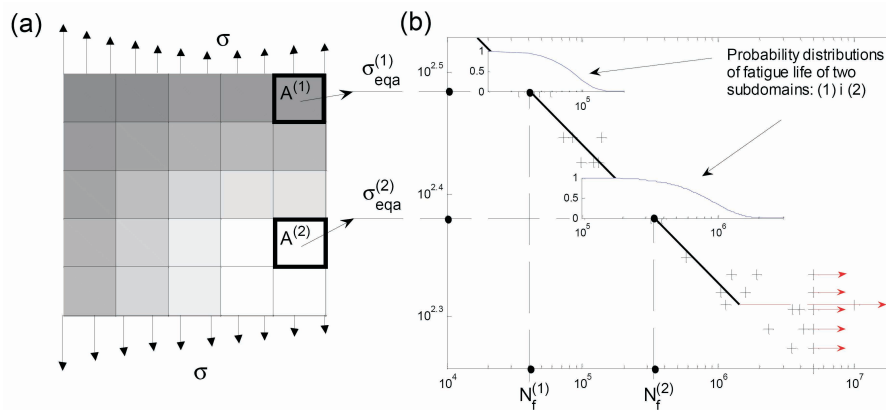

Fig. 4. (a) The separated subdomains of the element with homogeneous stress distributions, (b) distributions of probability of life P_e of particular subdomains against the fatigue characteristic

- (5) For each fatigue life N , the exponents of the number e from (11) are summed along all the subdomains $A^{(i)}$, and we obtain the function $P_e(N)$.
- (6) The distribution of probability of failure of all the element versus the number of cycles is a result of the simple operation: $P_f(N) = 1 - P_e(N)$.

- (7) The fatigue life N_{cal} of the maximum probability density is calculated for $P_f(N_{cal}) = 0.63$. Fatigue life for any other probability level, i.e. the scatter of results, can be calculated in a similar way.

5. Determination of parameters of two-dimensional distribution of failure probability

Taking advantage of the standard fatigue characteristic $\sigma_a - N_f$, the number of the two-dimensional distribution parameters (9) was reduced to two, i.e. A_0 and p . The reference surface area A_0 is the area with the uniform stress distribution characterized by distribution (10). When the fatigue characteristic $\sigma_a - N_f$ is applied, it is the free surface area of the specimen applied for determination of this characteristic. In the case of the steel considered in this paper, the round specimens 10 mm in diameter and the base length 40 mm were tested, so $A_0 = 1256 \text{ mm}^2$ [10].

The parameter p responsible for distribution of fatigue life scatters can be determined from the tests of specimens having the same distribution of defects (kind and morphology) as the considered element. However, qualities of elements and specimens are usually different. In such a case, the parameters of distribution should be fitted on the basis of one series of tests of a real element subjected to simple loadings. Such a procedure was applied, for example, by Delahay and Palin Luc [6] for determination of parameters of the one-dimensional distribution of type (2).

In this paper, the author applied different values of the parameter p , which were used while calculations of fatigue life and analysis of the proposed model.

6. The results of calculations

All initiations of the fatigue cracks in the cruciform specimens (Fig.1) were observed on the surface hole (Fig.2), thus calculations were reduced to that area. The crack planes coincided with the planes of maximum normal stresses. Thus, the criterion of maximum normal stresses on the critical plane was assumed as the criterion of multiaxial fatigue. The equivalent stresses are calculated according to the following equation

$$\sigma_{eq}(t) = \sigma_{ij}(t)n_i n_j, \quad (12)$$

where n_i is a vector perpendicular to the plane with the maximum normal stress. Under cyclic loadings described in chapter 2, the equivalent stress amplitude (12) at each point on the surface hole is equal to the maximum

principal stress σ_1 in the considered observation time. Owing to that, numerical calculations become easier. Because of loading symmetry and geometry, calculations were performed for 1/8 of the specimen (Fig.5). Division of the surface hole into finite elements and distribution of the equivalent stress amplitudes are shown in Fig.5. Surfaces of the finite elements were understood as subdomains $A^{(i)}$ described in chapter 4. Fig. 6 shows one of the obtained distributions of probability P_f of crack initiations (specimen P05, tab. 2).

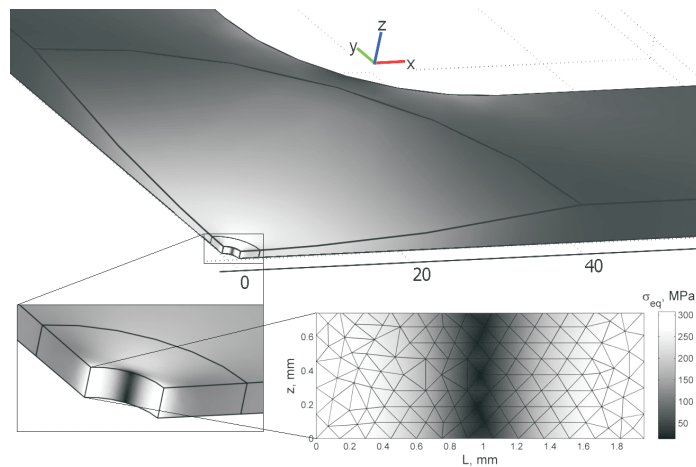

Fig. 5. 1/8 of geometry of the cruciform specimen with distribution of the equivalent stress σ_{eq} on the surface hole (specimen P05, Tab.2)

The distributions P_f were used for calculations of the number of cycles to crack initiation N_{cat} for three levels of probability: $P_f = \{0.05; 0.63; 0.95\}$ and for different values of the parameter p (Figs. 6b and 7a). The best agreement between the calculation and experimental fatigue lives was obtained for $p = 560$ (Fig. 7a). For such a parameter p , the fatigue life scatters were simulated for the basic fatigue characteristic $\sigma_a - N_f$ (Fig. 7b). From Fig. 7b it appears that in a big range of the fatigue life the experimental points $\sigma_a - N_f$ are included in the scatter band defined for $P_z = \{0.05; 0.95\}$. Only for $N_f > N_\sigma = 1.24 \cdot 10^6$ (the fatigue limit level) the fatigue life scatters are greater than the defined band.

The parameter $p=560$ should estimate the fatigue lives of the notched cruciform specimen under different loadings but of the same quality as those considered in the paper.

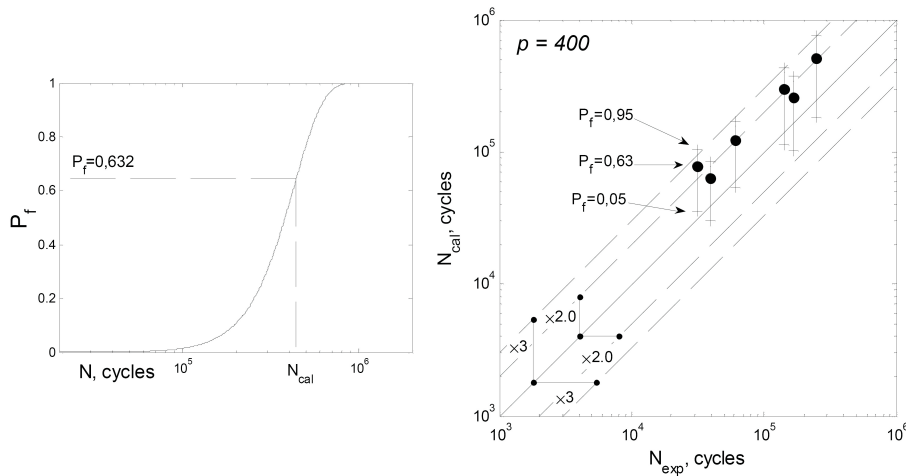

Fig. 6. (a) Distribution of probability of the crack initiation P_f for specimen P05 (Tab. 2), (b) comparison of the experimental N_{exp} and calculation life N_{cal} for $p=400$

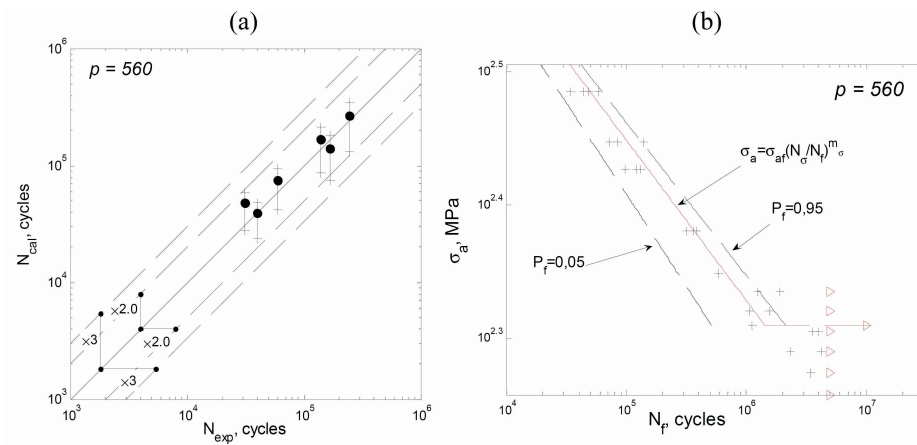

Fig. 7. (a) Comparison of the experimental life N_{exp} with the calculation life N_{cal} for $p=560$; (b) basic fatigue characteristic $\sigma_a - N_f$ with experimental points and with fatigue life scatter determined for $p=560$

7. Conclusions

The author proposed a procedure for determination of the two-dimensional distribution of probability of the element failure $P_f - N - \sigma$ and its application for calculations of fatigue life of structural elements. The presented approach allows calculating fatigue life at any probability level. Moreover, the approach includes non-uniform stress distribution in the material and the scale effect. The presented probability distribution according to (9) has a general form and it can be used for different fatigue characteristics (stress, strain or energy).

Generally speaking, the paper presents the two-dimensional distribution P_f – fatigue life – fatigue parameter.

The calculated fatigue life N_{cal} well correlates with the experimental fatigue life for $p \approx 560$.

The proposed function of distribution of probability (9) to the crack initiation needs determination of only one additional parameter (parameter p). Such a simple form is suitable for the considered cruciform specimens with holes. However, it should be expected that other elements made of the same steel but of different quality (manufacture process) will require determination of a more complicated distribution. The parameters of such distribution will be defined from additional tests.

The paper financed from the funds for science in 2007-2009 as a research project.

Manuscript received by Editorial Board, March 10, 2008;
final version, April 15, 2008.

REFERENCES

- [1] Papadopoulos I. V., Panoskaltsis V. P.: Invariant formulation of a gradient dependent multi-axial high-cycle fatigue criterion, *Engng Fract Mech* 55(4) (1996), pp. 513-528.
- [2] Morel F., Palin-Luc T.: A non-local theory applied to high cycle multiaxial fatigue, *Fatigue Fract Engng Mater Struct* 25 (2002), pp. 649-665.
- [3] Weibull W.: A statistical theory of the strength of materials, *Royal Swed. Inst. Engng Res. No 151* (1939), ps. 45.
- [4] Weibull W.: A statistical representation of fatigue failures in solids, *Transaction of The Royal Institute of Technology No 27*, Stockholm 1949, ps. 50.
- [5] Bomas H., Linkewitz T. Mayra P.: Application of a weakest-link concept to the fatigue limit of the bearing steel SAE 52100 in a bainitic condition, *Fatigue Fract Engng Mater Struct* 22 (1999), pp. 733-741.
- [6] Delahay T., Palin-Luc T.: Estimation of the fatigue strength distribution in high-cycle multi-axial fatigue taking into account the stress-strain gradient effect, *Int J Fatigue* 28 (2006), pp. 474-484.
- [7] COMSOL, *Structural Mechanics Module User's Guide*, version 3.3, 2006.
- [8] Karolczuk A., Lachowicz C.T., Rozumek D., Słowik J.: Badania inicjacji i propagacji pęknięć zmęczeniowych próbek krzyżowych w stali 18G2A, *Zeszyty naukowe Politechniki Świętokrzyskiej Nauki Techniczne – Mechanika Nr 4*, Kielce 2007, ss. 53-55 (50%), CD, s. 12.
- [9] Bazant Z. P., Novak D.: Probabilistic nonlocal theory for quasibrittle fracture initiation and size effect. I theory, *Journal of Engineering Mechanics*, Vol. 126, No. 2, (2000), pp. 166-174.
- [10] Łagoda T.: Energetyczne modele trwałości zmęczeniowej materiałów konstrukcyjnych w warunkach jednoosiowych i wieloosiowych obciążeń losowych, *Studia i monografie*, z. 121. Politechnika Opolska, 2001, ss. 147.

**Probabilistyczny model szacowania trwałości zmęczeniowej elementów konstrukcyjnych
o niejednorodnych rozkładach naprężeń**

Streszczenie

W pracy przedstawiono metodykę wyznaczania dwuwymiarowego rozkładu prawdopodobieństwa P_f inicjacji pęknięcia w funkcji trwałości zmęczeniowej N i parametru uszkodzenia zmęczeniowego σ : $P_f - N - \sigma$. Zaproponowany rozkład P_f wykorzystuje parametry standardowej charakterystyki zmęczeniowej i pozwala na obliczenie trwałości zmęczeniowej elementów o niejednorodnych polach naprężeń na dowolnym poziomie prawdopodobieństwa. Model został pozytywnie zweryfikowany na podstawie badań eksperymentalnych.