

Further Discussion on Modeling of Measuring Process via Sampling of Signals

Andrzej Borys

Abstract—In this paper, we continue a topic of modeling measuring processes by perceiving them as a kind of signal sampling. And, in this respect, note that an ideal model was developed in a previous work. Whereas here, we present its nonideal version. This extended model takes into account an effect, which is called averaging of a measured signal. And, we show here that it is similar to smearing of signal samples arising in nonideal signal sampling. Furthermore, we demonstrate in this paper that signal averaging and signal smearing mean principally the same, under the conditions given. So, they can be modeled in the same way. A thorough analysis of errors related to the signal averaging in a measuring process is given and illustrated with equivalent schemes of the relationships derived. Furthermore, the results obtained are compared with the corresponding ones that were achieved analyzing amplitude quantization effects of sampled signals used in digital techniques. Also, we show here that modeling of errors related to signal averaging through the so-called quantization noise, assumed to be a uniform distributed random signal, is rather a bad choice. In this paper, an upper bound for the above error is derived. Moreover, conditions for occurrence of hidden aliasing effects in a measured signal are given.

Keywords—measuring process, sampling of signals, smearing and averaging of signal samples

I. INTRODUCTION

IT has been shown in [1] that any measuring process can be viewed as a process of sampling signals. In [1], however, only preliminary results have been presented. That is this basic idea was illustrated via an idealized signal sampling, where the latter refers to as a pointwise operation of sampling. In other words, it refers to as such a one which produces perfect signal samples. However, as we know, this is not the case in practice. Signal samples are smeared and this effect must be taken into account in any realistic description of the signal sampling. And, it is also clear that this more realistic picture of the sampling operation transfers to the description of measuring processes we discuss here. Problems which go along with that are discussed here in detail.

The remainder of this paper is organized as follows. In the next section, we present two possibilities of modeling a nonideal sampling, in case of modeling a measuring process, to take into account also nonidealities in a model suggested in [1]: through introducing in it a smearing operation or an averaging operation of samples. We show that in principle these two operations, under some conditions, lead to receiving the same results. Section III is devoted to detailed derivations

of equations governing a nonideal model. In section IV, a thorough analysis of errors related to the signal averaging in a measuring process viewed as a kind of signal sampling is presented. Moreover, this analysis is illustrated with the use of some equivalent schemes for the relationships derived. Section V discusses conditions under which the two sources of errors foreseen by our model appear, and the problem of their harshness. We draw also attention in this section to the possibility of occurrence of hidden aliasing errors in case of measurements performed in very high frequencies. The paper ends with some concluding remarks.

II. SMEARING OR AVERAGING OF SAMPLES WHEN MODELING MEASURING PROCESSES ?

In the signal processing literature, the fact that the practically sampled values of a signal of a continuous time are not perfect “stamps” of this signal at the sampling instants is taken into account. How? Either by considering it as a kind of modulation of a carrier signal being a train of very short rectangular impulses by a continuous-time signal (to be sampled) [2] or by viewing it as an instantaneous local averaging of the latter signal [3], [4] (in the times between the successive sampling instants). It can be shown that under some assumptions these two approaches are equivalent to each other. Note further that smearing in sense of averaging of a physical quantity (as it is understood in physics; for example, see [5]), which takes place during its measurement, provides us also with a link to a special kind of signal (function) objects called distributions or generalized functions. This relationship is nicely explained in [5].

Consider now in more detail the averaging operation of a measured signal in the context of modelling measuring processes via sampling of signals. And to this end, consider a situation depicted in Fig. 1.

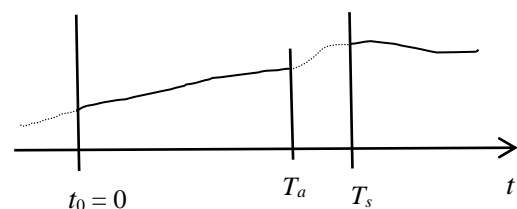

Fig. 1. A fragment of a measured continuous-time signal between two successive instants t_0 and T_s , which mean the beginning of the so-called “processing time” defined in [1] and the end of this period, respectively. In this period, it is assumed that the operation of signal averaging takes place in the time from an instant $t_0 = 0$ to an instant T_a .

Andrzej Borys is with the Department of Marine Telecommunications, Faculty of Electrical Engineering, Gdynia Maritime University, Gdynia, Poland (e-mail: a.borys@we.umg.edu.pl).



As shown in Fig. 1, we assume in our model here that the “processing time” as defined in [1] can be viewed as consisting of two parts: a one related strictly with a signal averaging operation, and the second, from the instant T_a to the instant T_s , devoted strictly to delivering the averaged value to a user (or archiving this value). In the latter time, the signal in Fig. 1 is depicted by a dotted line, but when averaged by a solid one.

By the way, note that for illustrating in terms used in telecommunications we could view the left-hand side solid vertical line at the instant $t_0 = 0$ as a “transmitter”, but the most right-hand side solid vertical line at the instant T_s as a “receiver”. In between, we would then have a “communication channel”. This “channel” would distort the input signal sample sent at $t_0 = 0$, say $x(t_0)$, by performing the operation of averaging. Next, the “receiver” would detect the “distorted” sample value at T_a , process it in the time from T_a to T_s , and finally would deliver to the “user” at the instant T_s . Consistently, the sample received at T_s at the output of the above “communication tract”, we would denote then by $y(T_s)$.

Let us now describe mathematically the process we explained with the use of Fig. 1 above. And, to be more illustrative, let us imagine that that what happens in Fig. 1 regards the measurement of temperature with the use of a thermometer. We refer here to this example because it is nicely described in [5] in the context that leads to formulation of the notion of distributions (generalized functions). Because of this reason the interested reader might want to become familiar with the explanations and description provided therein.

Assume here, similarly as in the Strichartz’s example in [5], that a function $f(\mathbf{r}, t)$ represents a physical quantity, say temperature, at a point \mathbf{r} in a room at a time instant t . Then, its measured value will be a result of averaging in both space and time. So, it can be written down in the following way:

$$\iint f(\mathbf{r}, t) \varphi(\mathbf{r}, t) d\mathbf{r} dt, \tag{1}$$

where the function $\varphi(\mathbf{r}, t)$ characterizes spatial and time averaging properties of a thermometer used. In the next step, assume to simplify further consideration that the operations of spatial and time averaging in a thermometer are performed independently. That is the variables \mathbf{r} and t in the function $\varphi(\mathbf{r}, t)$ can be separated from each other as follows

$$\varphi(\mathbf{r}, t) = \varphi_1(\mathbf{r}) \varphi_2(t), \tag{2}$$

where $\varphi_1(\mathbf{r})$ and $\varphi_2(t)$ are responsible for spatial averaging and time averaging, respectively.

According to Strichartz [5], interpreting of (1) as an averaging operation in space and time requires that the functions $\varphi_i(z_i)$, $i = 1, 2$, fulfil the following conditions:

$$\varphi_i(z_i) \geq 0, \quad i = 1, 2, \text{ everywhere,} \tag{3a}$$

and

$$\int \varphi_i(z_i) dz_i = 1, \quad i = 1, 2, \tag{3a}$$

where the integral is taken over all geometrical space or over all time space. The variables z_i , $i = 1, 2$, in (3) mean $z_1 = \mathbf{r}$ and $z_2 = t$, respectively.

Note now that using (2) in (1) we can rewrite the latter as

$$\int \left(\int f(\mathbf{r}, t) \varphi_1(\mathbf{r}) d\mathbf{r} \right) \varphi_2(t) dt. \tag{4}$$

Next, denoting the result of the inner integration in (4) by

$$\int f(\mathbf{r}, t) \varphi_1(\mathbf{r}) d\mathbf{r} = g(t), \tag{5}$$

we get finally from (4)

$$\int g(t) \varphi_2(t) dt. \tag{6}$$

We see that (6) expresses a pure averaging in time, and this will be a basis for our further considerations. So, we will apply (6) to the situation depicted in Fig. 1, where it is assumed that the operation of averaging takes place in the time from an instant $t_0 = 0$ to an instant T_a . Thus, for this case, (6) can be rewritten as

$$\int_{t_0=0}^{T_a} g(t) \varphi(t) dt, \tag{7}$$

where the subscript at $\varphi_2(t)$ was dropped for simplicity of further notation.

Now, to illustrate the averaging operation in time that is given by (7), let us choose the simplest possible form of $\varphi(t)$ in (7) that fulfils the conditions (3). We choose therein the following function:

$$\varphi(t) = \begin{cases} 1/T_a & \text{for } 0 < t < T_a \\ 0 & \text{elsewhere} \end{cases}, \tag{8}$$

This function is illustrated in Fig. 2.

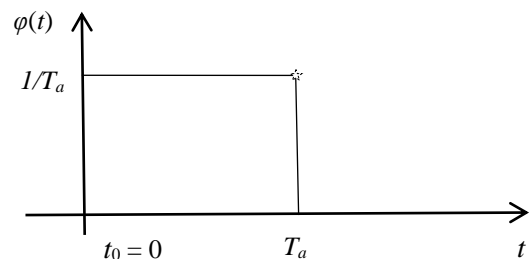

Fig. 2. A plot of the function $\varphi(t)$ given by (8).

Substituting (8) in (7) gives

$$\int_{t_0=0}^{T_a} g(t) \varphi(t) dt = \frac{1}{T_a} \int_{t_0=0}^{T_a} g(t) dt. \quad (9)$$

So, clearly, the result on the right-hand side of (9) shows that choosing the function (8) in (7) leads to a “pure” averaging of the signal (function) $g(t)$ in the period from $t_0 = 0$ to T_a .

Further note that choosing another form of the function $\varphi(t)$ that fulfils the conditions (3) would also result, besides of averaging, in a kind of “additional weighting” (of this averaging). In many cases, such a mixed operation proves to be very useful, as, for example, in signal (function) shaping with the use of a Gaussian impulse [6]. Moreover, it should be also noticed here that the functions $\varphi(x, t)$ in (1), $\varphi_2(t)$ in (6), and $\varphi(t)$ in (7) play a role of the so-called test function in the theory of distributions [7]. That is (1), (6), and (7) can be then interpreted as distributions.

We will show now that (9) with $\varphi(t)$ given by (8) can be expressed equivalently as a convolution integral. To this end, we rewrite (9) in the following way:

$$\begin{aligned} \frac{1}{T_a} \int_{t_0=0}^{T_a} g(t) dt &= \int_{t_0=0}^{T_a} g(t) \varphi(t) dt = \\ &= \int_{-\infty}^{\infty} g(\tau) \varphi(-(\tau - T_a)) d\tau. \end{aligned} \quad (10)$$

In (10), a new variable τ instead of t has been introduced. Moreover, we have applied therein the following facts: $\varphi(t)$ is identically equal to zero outside the range $(0, T_a)$, $\varphi(\tau) = \varphi(-\tau)$, and $\varphi(\tau) = \varphi(-(\tau - T_a))$. These properties are illustrated in Fig. 3.

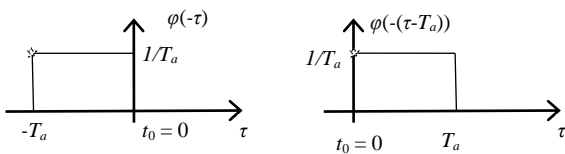

Fig. 3. Properties of the function $\varphi(t)$ given by (8) that are exploited in derivation of (10).

And, finally, (10) can be rewritten as

$$\frac{1}{T_a} \int_{t_0=0}^{T_a} g(t) dt = \int_{-\infty}^{\infty} g(\tau) \varphi(T_a - \tau) d\tau = y(T_a). \quad (11)$$

It follows from (11) that the averaging operation carried out on the signal (function) $g(t)$ can be interpreted as applying it as an input signal $x(t) = g(t)$ to a filter having an impulse response, say $h(t)$, equal to $\varphi(t)$ given by (8). At the output

of this filter, we get the value of $y(T_a)$ at the instant T_a . Moreover, it follows immediately from the above derivation that for all the other functions $\varphi(t)$ possessing the same properties as the function given by (8) the relationship (11) holds, too.

Also, equality (11) proves an equivalence of the operations of smearing and averaging of samples of measured signals, when describing a measuring process via sampling of signals. Obviously, this holds perfectly only when the conditions imposed on the function $\varphi(t)$, which were given above, are fulfilled.

III. A NONIDEAL VERSION OF THE PROPOSED MODEL OF MEASURING PROCESS VIA SIGNAL SAMPLING

We understand under a nonideal version of the model of a measuring process via sampling of signals, which was proposed in [1], a model taking into account the fact that sampling is not carried out pointwise. A basic idea of it is presented in Fig. 2 of the previous section. Moreover, further elements of this model are given by the expressions derived in the latter section.

Let us now denote a measured signal, which is subject of averaging, by $g_a(t)$ and its “samples” at time instants of “picking up” its values as $g_a(nT_s)$, $n = \dots, -2, -1, 0, 1, 2, \dots$. So, using this and results given by (9-11), we can write

$$\begin{aligned} g_a(nT_s) &= \frac{1}{T_a} \int_{(n-1)T_s}^{(n-1)T_s+T_a} g(t) dt = \\ &= \int_0^{T_a} g((n-1)T_s + \tau) \varphi(\tau) d\tau = \\ &= \int_{-\infty}^{\infty} g((n-1)T_s + \tau) \varphi(-(\tau - T_a)) d\tau = \\ &= \int_{-\infty}^{\infty} g((n-1)T_s + \tau) \varphi(T_a - \tau) d\tau. \end{aligned} \quad (12)$$

Further, note that according to Fig. 1 the following relation:

$$T_a < T_s \quad (13)$$

holds in our model. Furthermore, it follows from the sampling theorem and the reconstruction formula [3], [4] that if

$$\frac{1}{T_s} = f_s \geq 2f_{ma} \quad \text{or} \quad f_{ma} T_s \leq \frac{1}{2} \quad (14)$$

is satisfied, where f_{ma} stands for the maximal frequency present in the spectrum of the signal $g_a(t)$ and $f_s = 1/T_s$, then a perfect reconstruction of this signal from its “samples” $g_a(nT_s)$, $n = \dots, -2, -1, 0, 1, 2, \dots$, is possible. And, the latter signal will be then given by

$$g_a(t) = \sum_{n=-\infty}^{\infty} g_a(nT_s) \operatorname{sinc}(t/T_s - n), \quad (15)$$

where the function $\operatorname{sinc}(t)$ is defined as

$$\operatorname{sinc}(t) = \sin(\pi t)/\pi t \text{ for } t \neq 0 \text{ and } 1 \text{ for } t = 0. \quad (16)$$

Obviously, under the assumption that in case of our unknown signal $g(t)$ the following

$$\frac{1}{T_s} = f_s \geq 2f_m \text{ or } f_m T_s \leq \frac{1}{2} \quad (17)$$

also holds, where now f_m stands for the maximal frequency present in the spectrum of $g(t)$, the latter signal can be, similarly as $g_a(t)$, expressed through its “samples” as

$$g(t) = \sum_{n=-\infty}^{\infty} g(nT_s) \operatorname{sinc}(t/T_s - n). \quad (18)$$

See now that the difference between the “distorted” (through a measuring process we model here) values of “samples” $g_a(nT_s)$ and their unknown counterparts $g(nT_s)$ (that is “true” values) can be expressed as

$$g_a(nT_s) - g(nT_s), \quad n = \dots, -2, -1, 0, 1, 2, \dots \quad (19)$$

Further, the difference given by (19) can be understood as an error in the values of samples referred to the time instant nT_s (or picked up at this time instant). Denote it as $e_g(nT_s)$. So, in the next step, using (15), (18), and (19), we can express the “error signal”, $e_g(t)$. It is given by

$$e_g(t) = \sum_{n=-\infty}^{\infty} (g_a(nT_s) - g(nT_s)) \operatorname{sinc}(t/T_s - n). \quad (20)$$

Now, let us use (12) in (19). This gives

$$\begin{aligned} e_g(nT_s) &= g_a(nT_s) - g(nT_s) = \\ &= \int_0^{T_a} g((n-1)T_s + \tau) \varphi(\tau) d\tau - g(nT_s), \quad (21) \\ n &= \dots, -2, -1, 0, 1, 2, \dots \end{aligned}$$

Observe that a simplification of (21) is possible if we assume that the function $g(t)$ is a continuous function on the intervals $\langle (n-1)T_s, (n-1)T_s + T_a \rangle$, $n = \dots, -1, 0, 1, \dots$, and the function $\varphi(t)$ is a positive continuous one on the interval $\langle 0, T_a \rangle$. We see that this is the case in (21). So, using then

the so-called mean value theorem (for integrals) [7], we can rewrite (21) as

$$\begin{aligned} e_g(nT_s) &= g((n-1)T_s + \xi_n) \int_0^{T_a} \varphi(\tau) d\tau - g(nT_s), \quad (22) \\ n &= \dots, -1, 0, 1, \dots, \end{aligned}$$

where $(n-1)T_s + \xi_n$, $n = \dots, -1, 0, 1, \dots$, means a certain point in the interval $\langle (n-1)T_s, (n-1)T_s + T_a \rangle$, $n = \dots, -1, 0, 1, \dots$, for which (22) is satisfied (its existence follows from the theorem mentioned above). And, applying (3a) in (22), we arrive finally at

$$\begin{aligned} e_g(nT_s) &= g((n-1)T_s + \xi_n) - g(nT_s), \quad (23) \\ n &= \dots, -1, 0, 1, \dots \end{aligned}$$

Equation (23) will be a basis in the next section for a framework of an analysis of the error occurring in the measuring process of a signal or, in other words, of a jitter in the measured values of a signal.

IV. A FRAMEWORK FOR ANALYSIS OF ERROR OR JITTER IN VALUES OF MEASURED SIGNALS

At first glance, it seems that any qualitative and/or quantitative analysis of errors (which are also called here jitter) in the measured values of a signal, can be carried out similarly as that performed in analyzing processes of amplitude quantization of acoustic or other low-band signals [8], [9]. Precisely because the fact that we view here any measuring process as a kind of signal sampling, which, on the other hand, is inherently connected with the signal amplitude quantization. However, we will show in this section that these two processes have rather different characteristics. And, to this end, let us start with recalling shortly the modelling of amplitude quantization of acoustic signals as given, for example, in [8] or [9]. A basic scheme of it is shown in Fig. 4.

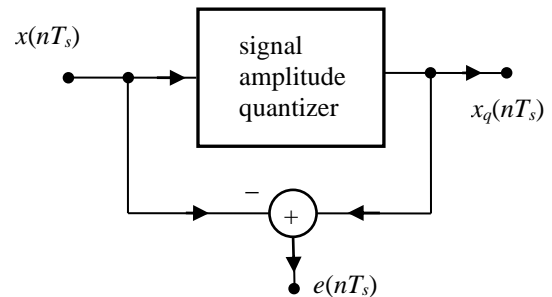

Fig. 4. A basic scheme of signal amplitude quantization after [8] and [9].

It follows from Fig. 4 that the error (difference) $e(nT_s)$ between the values of continuous-amplitude but discrete-time samples $x(nT_s)$ of a signal and their quantized values $x_q(nT_s)$ is given by

$$e(nT_s) = x_q(nT_s) - x(nT_s), \quad n = \dots, -1, 0, 1, \dots \quad (24)$$

Note now that using the same convention, which was applied above to illustrate (24) in Fig. 4, we can visualize (23) as depicted in Fig. 5.

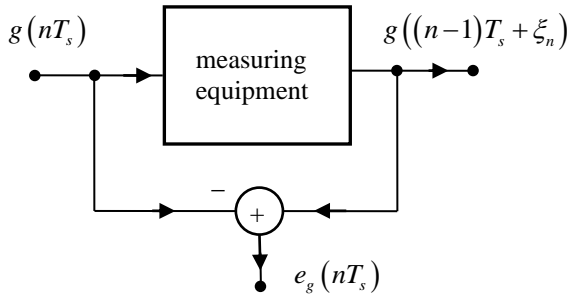

Fig. 5. A scheme illustrating relation (23).

Furthermore, observe that we can rewrite (23) and (24) in a form that applies operator convention. That is in the following way:

$$\begin{aligned} y(nT_s) &= x_q(nT_s) = P_Q(x(nT_s)) = \\ &= x(nT_s) + e(nT_s), \quad n = \dots, -1, 0, 1, \dots \end{aligned} \quad (25)$$

and

$$\begin{aligned} y(nT_s) &= g((n-1)T_s + \xi_n) = P_M(g(nT_s)) = \\ &= g(nT_s) + e_g(nT_s), \quad n = \dots, -1, 0, 1, \dots, \end{aligned} \quad (26)$$

where $P_Q(x(nT_s))$ and $P_M(g(nT_s) = x(nT_s))$ are operators describing the behavior of a quantizer in Fig. 4 and of a measuring equipment in Fig. 5, respectively. The descriptions given by (25) and (26), and their corresponding visualizations shown in Figures 4 and 5 represent mappings of input samples $x(nT_s)$ and $x(nT_s) = g(nT_s)$ into the corresponding output ones $y(nT_s)$.

In digital signal processing [8], [9], [11], a widely used way for interpretation of amplitude quantized samples of a signal is to treat them as “true values” $x(nT_s)$ distorted by additive “noise samples” $e_g(nT_s)$. And that is what (25) expresses. Moreover, the latter can be also viewed as a description of an “equivalent device” having no memory that processes the signal samples.

At first glance, it may seem that the model presented in Fig. 4 does not support the above interpretation. In what follows, we will show that this is merely an illusion. To convince the reader of this, we need however to carry out some rearrangements in the lower branch of the scheme of Fig. 4. They are visualized in Fig. 6; and note that the lowest (resulting) graph in Fig. 6 corresponds with equation (25).

The so-called quantization noise represented by the samples $e(nT_s)$, $n = \dots, -1, 0, 1, \dots$, in (25) is most often modeled, in the

digital signal processing literature [8], [9], [11], as a discrete stochastic process with a uniform distribution. This model follows from the Widrow’s quantization theorem [10] and works good when the following two assumptions: 1. a dynamic range of the signal amplitude samples $x(nT_s)$ is enough wide; 2. the error signal samples $e(nT_s)$ are very weakly correlated with the signal amplitude samples $x(nT_s)$, hold.

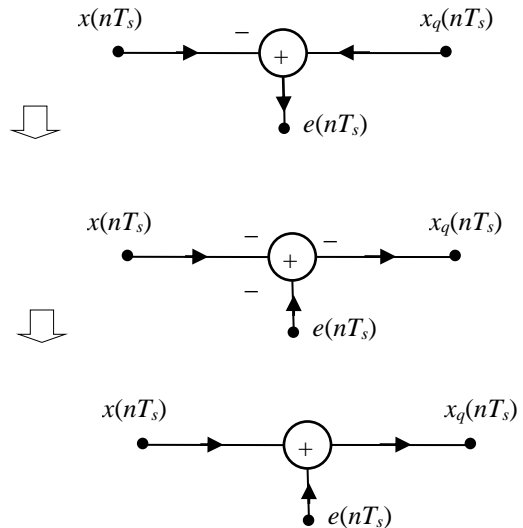

Fig. 6. Rearrangements of the lower branch of the scheme in Fig. 4 proving graphically relation (25).

Note now that because of the same forms of relations (25) and (26) - specifically, see the second lines in (25) and (26) - it may be supposed that there exist measuring processes in which the measuring errors can be modeled similarly as the quantization noise in digital signal processing. Which ones? This is a problem for further investigations.

In general, however, we must admit that these two processes of error or jitter generation mentioned above differ from each other. That is the character of a signal amplitude quantization error differs from that which occurs in measured values of a signal. This follows from the fact that actually in the latter case no input signal should be indicated in the scheme of Fig. 5. Rather, in this case, we should use an equivalent scheme which is shown in Fig. 7.

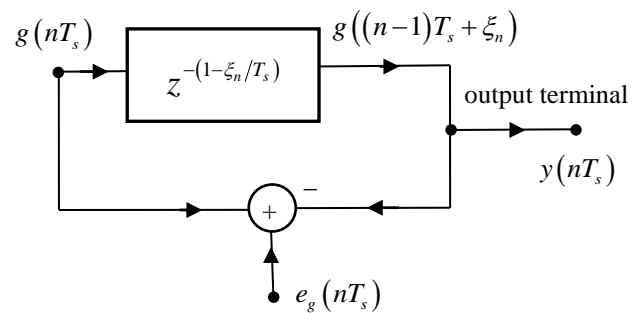

Fig. 7. A scheme illustrating relation (25); it is equivalent to the scheme of Fig. 5.

Note that the scheme of Fig. 7 resembles a generator loop that “generates measured samples of a signal” and makes them available on the “output terminal”. The loop incorporates a time delay of the length $(1-\xi_n/T_s)$ between the “left-hand side and right-hand side nodes”; it is visualized in Fig. 7 by an element $z^{-(1-\xi_n/T_s)}$ (using a notation similar to that used for a delay element in equivalent circuits of digital filters). Furthermore, observe that the variable ξ_n , $n = \dots, -1, 0, 1, \dots$, changes from sample to sample, making the delay $(1-\xi_n/T_s)$ variable. Fig. 7 expresses also the fact that the error signal samples $e_g(nT_s)$ are very strongly dependent upon the samples $g((n-1)T_s + \xi_n)$ and $g(nT_s)$. For this, see what happens in a summation element at the lower branch of the scheme of Fig. 7. The sum of these three samples mentioned above equals zero there, for all $n = \dots, -1, 0, 1, \dots$.

Let us now expand $g((n-1)T_s + \xi_n)$ in (26) in a Taylor series of a variable ξ_n and leave only the first two terms in it (a first component that is independent of ξ_n as well as a linear one). We get then from (26)

$$\begin{aligned} g((n-1)T_s + \xi_n) &\cong \\ &\cong g((n-1)T_s) + \left. \frac{dg(t)}{dt} \right|_{(n-1)T_s} \cdot \xi_n = \\ &= g(nT_s) + e_g(nT_s), \quad n = \dots, -1, 0, 1, \dots \end{aligned} \quad (27)$$

In the next step, let us also expand the sample $g(nT_s) = g((n-1)T_s + (nT_s - (n-1)T_s))$ in a Taylor series of a variable $(nT_s - (n-1)T_s) = T_s$ in the vicinity of the time instant $(n-1)T_s$. This gives

$$\begin{aligned} g(nT_s) &\cong g((n-1)T_s) + \left. \frac{dg(t)}{dt} \right|_{(n-1)T_s} \cdot T_s \\ n &= \dots, -1, 0, 1, \dots \end{aligned} \quad (28)$$

In (27) and (28), $dg(t)/dt|_{(n-1)T_s}$ means a derivative of the function $g(t)$, calculated at the time instant $(n-1)T_s$. Moreover, we assume here that the function $g(t)$ is continuous and its derivative exists everywhere.

Substituting (28) into (27), we arrive at

$$e_g(nT_s) \cong \left. \frac{dg(t)}{dt} \right|_{(n-1)T_s} \cdot (\xi_n - T_s), \quad n = \dots, -1, 0, 1, \dots \quad (29)$$

Taking into account the fact that the maximal value of the magnitude of $(\xi_n - T_s)$ equals T_s , we can write

$$\max |e_g| \cong \max \left| \frac{dg(t)}{dt} \right| \cdot T_s \quad (30)$$

The relation (30) states that the maximal error in a measuring process $\max |e_g|$ is approximately equal to the maximal value of the derivative of the function $g(t)$ times the period T_s . It can be expressed in the following equivalent form:

$$\max |e_g| \cong \frac{SR}{f_s}, \quad (31)$$

where $f_s = 1/T_s$ means “a sampling frequency associated with the model of a measuring process which is proposed in this paper”, and SR means the so-called slew-rate that is used in the literature for denoting the maximal change of a signal per time unit. That is in our case $SR = \max |dg(t)/dt|$.

From (31), we see that the maximal error $\max |e_g|$ is larger for larger values of SR . But, its dependence upon the frequency f_s is reversed. That is the maximal error $\max |e_g|$ is inversely proportional to f_s . Additionally, it seems that both these dependencies are intuitively understandable.

Finally, observe that it follows from (31) that if f_s goes to infinity, then the error estimate $\max |e_g|$ approaches zero.

V. TWO SOURCES OF ERRORS FORESEEN BY OUR MODEL

From the discussion presented in sections II, III, and IV, it follows that our model foresees occurrence of two kinds of errors, which can appear in a measuring process. These are the following ones: 1. aliasing effects when the inequality (17) is not satisfied; 2. errors or jitter in values of a measured signal caused by averaging or smearing of signals by a measuring equipment.

Note that the first of the errors mentioned above rather does not appear in practice because of the fact that in measurements performed correctly T_s is “chosen” to be so small that the following: $f_s \gg 2f_m$ holds. Hence, $f_s \geq 2f_m$ is satisfied all the more. However, problems can occur with fulfilling the inequality $f_s \geq 2f_m$ when measuring signals that contain very high frequency components, for example, in the ranges above 100 Gz. Then, it can happen that we will not have simply a measuring equipment working with the parameter f_s satisfying $f_s \geq 2f_m$. And, we will not even be aware of this fact (because f_s is an abstract parameter). In other words, we will be confronted then with a kind of hidden aliasing effects.

And once again, in this context, we remind that T_s in our model is rather an abstract variable. So, its value is not “chosen” by anybody. It characterizes inertia of a measuring equipment modeled and assumes a value that follows from characteristics of this inertia.

The second kind of errors mentioned above is always present. It is sometimes less and sometimes more troublesome or acute in measurements. Equation (29) shows that it has a random character, mostly because of a very random character of the variable ξ_n . The maximal value of error in (29) is estimated to be as given by (30). However, it seems that this is rather a pessimistic estimate for practical cases because the variable ξ_n in (29) rather does not seem to approach zero value for none of the indices $n = \dots, -1, 0, 1, \dots$. Because of this reason, we will write

$$\max |e_g| < \frac{SR}{f_s} \quad (32)$$

in what follows, instead of the relation given by (31).

Note now that the upper bound SR/f_s for $\max |e_g|$ in (32), before the occurrence of aliasing effects, assumes its greatest value for $f_s = 2f_m$. Then, we can rewrite (32) as

$$\max |e_g|_{f_s=2f_m} < \frac{SR}{2f_m} . \quad (33)$$

And when, for example, $f_s = 2 \cdot 10^5 f_m$, then we get from (32)

$$\max |e_g|_{f_s=2 \cdot 10^5 f_m} < \frac{SR}{2 \cdot 10^5 f_m} = 10^{-5} \frac{SR}{2f_m} . \quad (34)$$

Comparison of (33) with (34) shows a role of the parameter f_s ; it characterizes a measuring equipment in keeping measuring errors as small as possible. This parameter should have so large value as possible, and substantially greater than the value of $2f_m$.

VI. CONCLUDING REMARKS

This paper is a continuation of the previous one [1], in which a model of a measuring process via sampling of signals has been proposed. Here, this model is extended to take into account an effect of averaging or smearing of samples when modelling measuring processes. So, the model developed in this paper can be viewed as a nonideal version of that presented in [1].

In this paper, differences which exist between the model of a measuring process via sampling of signals, derived here, and the model used for modeling of operation of signal sampling in digital techniques are pointed out and discussed in detail. Furthermore, their analysis is illustrated with some equivalent schemes of the relations derived. And, it seems that some of them, as, for example, (26) can be modeled with the use of Markov processes with continuous sets of events. Moreover, in this context, note that such an approach would lead automatically to a probabilistic treatment of errors discussed in section III. So, this perspective could give impetus to further investigations in the area.

REFERENCES

- [1] A. Borys, "Measuring process via sampling of signals, and functions with attributes," submitted to *Int. Journal of Telecommunications and Electronics (JET)*.
- [2] P. A. Lynn, Chapter 8: *Modulation and Sampling in An Introduction to the Analysis and Processing of Signals*, London: Palgrave, 1982.
- [3] M. Vetterli, J. Kovacevic, and V. K. Goyal, Chapter 5: *Sampling and Interpolation in Foundations of Signal Processing*, Cambridge: Cambridge University Press, 2014.
- [4] A. Boggess and F. J. Narcowich, *A First Course in Wavelets with Fourier Analysis*, New York: John Wiley & Sons, 2011.
- [5] R. Strichartz, Chapter 1: *What are Distributions?* in *A Guide to Distribution Theory and Fourier Transforms*, Boca Raton: CRC Press, 1994.
- [6] J. G. Proakis, *Digital Communications*, New York: McGraw-Hill, Inc., 1995.
- [7] R. F. Hoskins, Chapter 1: *Results from Elementary Analysis in Delta Functions: An Introduction to Generalised Functions*, Oxford: Woodhead Publishing, 2010.
- [8] U. Zölzer, *Digital Audio Signal Processing*, Chichester: John Wiley & Sons, 2008.
- [9] K. Sozański, *Digital Signal Processing in Power Electronics Control Circuits*, London: Springer-Verlag, 2013.
- [10] B. Widrow, "Statistical analysis of amplitude-quantized sampled-data systems", *Trans. AIEE, Pt. II*, vol. 79, pp. 555–568, January 1961.
- [11] A. V. Oppenheim and R. W. Schaffer, *Discrete-Time Signal Processing*, New York: Pearson, 2010.