

# Properties of a Wireless Mesh Network Constructed with the Use of IQRF Modules in the Indoor Environment

Sławomir Pluta, and Patryk Roszkowski

**Abstract**—The subject of the article is the design and practical implementation of the wireless mesh network. IQRF radio modules were used for the network design. The IQRF® technique has enabled the construction of a mesh network with the possibility of reconfiguration. The theoretical part contains a description of the IQRF® hardware solutions used. The practical scope includes the design part, where the configuration of the radio modules was carried out and the parameters of the radio network were set to allow its implementation in various topologies. Then, a wireless network consisting of 10 IQRF modules was launched in the P3 building of the Opole University of Technology. At this stage, configured radio modules were placed in selected rooms on all five floors of the building in order to carry out tests of the radio network constructed in this way. The tests included measuring the packet transmission delay time as well as the received signal strength. Research was carried out for several network topologies.

**Keywords**—wireless mesh network, WMN, IQRF, indoor environment, IoT

## I. INTRODUCTION

MESH topology is often used in wireless networks . Mobile Ad Hoc Networks (MANET) and Wireless Sensor Network (WSN) are now the basic way to provide new IoT (Internet of Things) and Machine-to-Machine communication platforms [1,2]. WSN is an ad hoc multi-hop network consisting of a large number of wireless sensors [3-6]. WSN and MANET networks open up new possibilities in monitoring, remote measurement and control. Often, wireless mesh networks are used to implement these solutions. WMN (Wireless Mesh Networks) are characterized by fixed, wireless relay nodes that form the backbone of the infrastructure for mobile access nodes in accordance with the grid topology. In a mesh network, data is transferred using multiple hops. The main advantages of wireless mesh networks are: ability to respond to network failures, easy expansion and high throughput. The use of such a solution is necessary to ensure a high level of security and reliability. In the event of a node failure, it is possible to reach it by another route, which significantly increases the reliability of the network. There are many technologies that enable communication in a mesh environment, such as WiFi, Bluetooth, ZigBee etc [7-13].

Catalog information and drawings regarding IQRF solutions have been included in the article with the consent of MICRORISC s.r.o. and IQRF Tech s.r.o.

S.Pluta and P. Roszkowski (student) are with the Institute of Control, Opole University of Technology, Opole, Poland, (e-mail:s.pluta@po.edu.pl, patrykr27@gmail.com).

There are also specialized technologies that are able to provide much better parameters for mesh networks, such technology is Microrisc IQRF® [14,15]. Wireless mesh networks (WMN) are self-organizing and automatically reconfigured, and the nodes in the network automatically establish an ad hoc network and maintain mesh connectivity. WMN consists of two types of nodes: routers and mesh clients. In IQRF networks, the “coordinator” plays the role of the router, and the “node” is the client. The IQRF® system has enabled the construction of a mesh network with the possibility of reconfiguration.

The article presents the results of research conducted in order to assess possibilities of practical implementation of the wireless mesh network in the indoor environment. The IQRF® modules were used for the network design. The configuration and construction of the network will be carried out in the IQRF® IDE4 system environment for operation in the 868 MHz ISM band. The work can be divided into theoretical and practical parts. The theoretical part contains a description of the IQRF® hardware and software solutions used. The practical scope includes the design part, where the configuration of the radio modules was carried out. The parameters of the radio network were set to allow its implementation in various topologies. Then, a radio network consisting of ten IQRF® modules was launched in the P3 building of the Opole University of Technology. At this stage, configured radio modules were placed in selected rooms on all five floors of the building in order to carry out tests of the radio network constructed in this way. The mesh network performance measurements were made. The tests included measuring the packet transmission delay time as well as the received signal strength. Research was carried out for several network topologies.

The IQRF® technology itself and the devices used to build the radio network will be described in Chapter II. The technical specifications and capabilities of the IQRF® environment will be shown. In Chapter III, the mesh network project in the indoor environment will be presented. Chapters IV - VII demonstrate the results of tests of the radio network in operation.

## II. DESCRIPTION OF THE IQRF® TECHNOLOGY

MICRORISC has been developing the IQRF® wireless technology since 2004 [14]. IQRF Tech as a technological spin-off of MICRORISC took over the development of the IQRF® Core Infrastructure in 2017. This technology was used to design the wireless mesh network [15]. It is an integrated platform using radio modules operating in the ISM band.



IQRF<sup>®</sup> is a technology that provides low power, low speed, low data volume, reliable and easy-to-use wireless connectivity in ISM bands below 1 GHz and range up to several hundred meters. It is very useful for telemetry, industrial control and automation of buildings and cities (street lamps, parking lot etc.). It is used when there is a need for wireless transfer, e.g. remote control or remote data acquisition. A typical application of IQRF is IoT. Hundreds of real projects with over 250 000 devices based on IQRF<sup>®</sup> are completed so far. IQRF<sup>®</sup> Alliance is a group of companies and institutions building up an ecosystem of interoperable wireless devices based on the IQRF<sup>®</sup> technology and related gateways, clouds, mobile apps, integration platforms etc. [16]. The Technical University of Opole is a member of this alliance.

IQRF<sup>®</sup> is a complete technology / platform including hardware (transceivers, gateways, repeaters), development tools, software, protocols, support and services. IQRF<sup>®</sup> technology has unique values:

- IQRF<sup>®</sup> routing protocol utilizing directional flooding brings outstanding network robustness,
- IQRF<sup>®</sup> DPA commands (a standardizing language) assure simple integration and interoperability,
- FRC (Fast Response Commands) dramatically increase network throughput and reliability,
- OTA (Over-The-Air) service enables remote centralized network management lowering maintenance costs,
- Multilayer security based on industrial standards is extended by dynamic keys generation and exchange,
- Low power with sophisticated power management modes.

IQRF<sup>®</sup> is based on wireless RF transceivers (TR). They are supported by the operating system (OS). The operating system implements the link layer and the network layer supporting the mesh network using the IQMESH<sup>®</sup> protocol. Specific functionality can be obtained by placing user software into the internal MCU (microcontroller unit). In addition to normal operation, each TR can route packets to other nodes to extend coverage and increase mesh reliability. Support for all TR transceivers is provided via software (SW) plug-in instead of user-specific software. The device is controlled only by sending and receiving commands and data, using a simple DPA protocol (Direct Peripheral Access). Typical operating bands for modules are: 868 MHz, 433 MHz and 916 MHz [15]. The devices are managed using an integrated development environment IQRF<sup>®</sup> IDE4, in which all parameters of the modules are set. The modules have a microcontroller, which makes it possible to write code in C language. Functionality depends on user application written in C language or ready-to-use plug-in. IQRF<sup>®</sup> SDK is a programming package for programming in C.

#### A. IQRF<sup>®</sup> Transceiver

IQRF<sup>®</sup> Transceiver (TR) is a small intelligent electronic board with a complete circuitry needed to implement wireless RF communication. This is a key element of communication in the IQRF<sup>®</sup> technology. Main features [17]:

- compact, highly integrated design, no external components,
- MCU with embedded IQRF<sup>®</sup> (OS) operating system supporting mesh network,
- fully programmable in C,
- all TRs are transceivers controlled by data - they enable the application without programming,

- unlicensed sub-GHz band, worldwide (433, 868 and 916 MHz),
- RF output power up to 18 mW, programmable,
- range of 500 m line of sight / 200 m municipal area / 50 – 100m indoor /transmit power 12 mW, (up to several km in special cases) for hops,
- topology- full mesh with 240 hops (used in real applications), 239 nodes,
- protocol IQMESH<sup>®</sup>, patented directed flooding networking, secure communication, redundant packet deliver, no latency after reset, etc.,
- power consumption: standard RX /12.3 mA, Low Power RX/ 170  $\mu$ A, deep sleep /< 100 nA, sleep /2  $\mu$ A.

The TR-72DAT radio modules of the IQRF<sup>®</sup> system were used to build the network. They are equipped with a temperature sensor. TRs can also be hosted by CK-USB-04A module connected to PC via USB. It enables to control the TR application from PC, first of all by the IQRF IDE powerful tools for communication, testing, network management and visualization. This is advantageous especially for the network Coordinator. An optional sensor development kit contains a potentiometer for voltage measurement, a photo-resistor for light intensity measurement and a Dallas 18B20 temperature sensor.

Fig. 1 shows view of module TR-72DAT and DK-EVAL-04A kit. In Fig.2 block diagram of the TR-72DA module is presented.

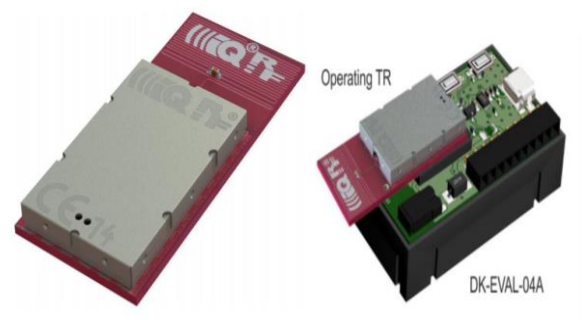

Fig. 1. Module TR-72DAT alone (left) and hosted in portable DK-EVAL-04A kit (right) [17]

The radio range strongly depends on the design of the devices, the location of the TR module relative to the ground plane and conductive areas as well as the positioning of the antenna are particularly important (Fig. 3.). On Fig.3 output power vs. antenna orientation is shown.

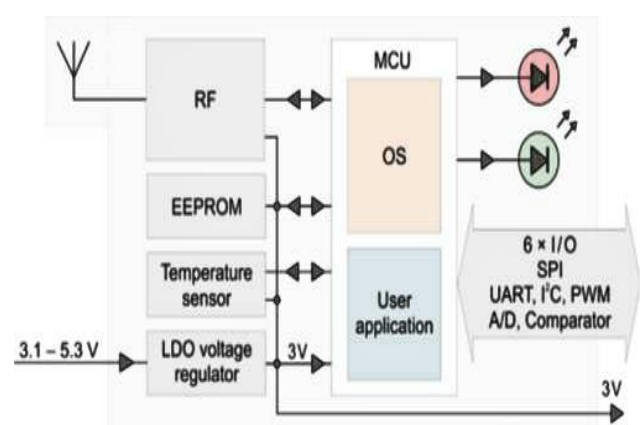

Fig. 2. Block diagram of TR-72DA [17]

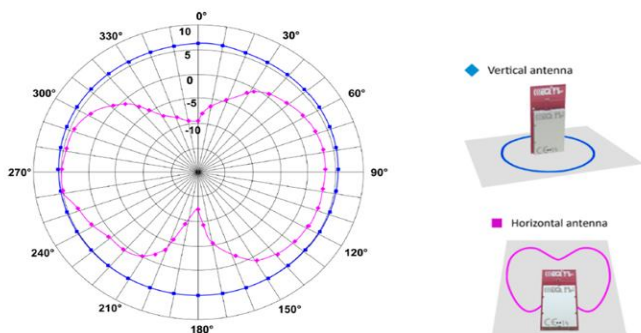

Fig. 3. TR-72DAT RF output power [in dBm] vs. antenna orientation (radiation patterns) and examples of the two installation position of module [17]

Maximum transmitter output power is set up to 10 dBm (for 50 Ω load). Transmitter output signal power (TX Power) can take 8 levels (0-7) as illustrated in Fig. 4. A very important aspect that must pay attention to is the position of the antenna and the "RX filter" parameter [17]. To increase the RF interference immunity, the received RF signal can be filtered depending on the level of received signal [17]. The "RX filter" parameter significantly affects the network range. If its value is higher, the range between the Node and Coordinator is smaller. The RF sensitivity is set on -101 dBm.

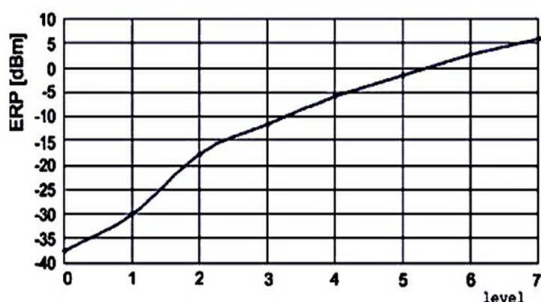

Fig. 4. Effective radiated power (ERP) vs. level in the set TX Power(level) function. TR-72D(A), 868 MHz band, channels 0 to 67[17]

**B. Properties of the IQMESH® protocol**

The transport layer is provided using the DPA protocol. IQMESH® network is implemented by the DPA Framework [18]. It is a protocol that allows control by sending commands and receiving responses via a standard wired interface (UART or SPI) or RF. The network contains just one Coordinator and up to 239 Nodes. From the RF and power consumption point of view, two Node types are available:

- STD Node: Not power saving during RF RX (receiving in STD RX mode), typically powered from mains or a high-power battery,
- LP Node: Power saving during RF RX (receiving in LP RX mode), typically powered from a small battery.

IQRF has the ability to independently receive and transmit with a good network connection, so it can connect 240 modules. The solution allows connect a maximum of 239 nodes to one coordinator, a total of (239 + 1) in one network. Each IQRF module can act as a network Coordinator or as a Node. The option of connecting subsequent nodes in real time is also available. This feature means that IQRF finds routing paths automatically for transparent addressing of randomly distributed nodes.

When connecting a large number of nodes, there is a problem with the speed of reading data from individual modules. To improve this, FRC (Fast Response Command) was used, thanks to which the most important, small data packets are sent. This kind of solution is an order of magnitude faster than the standard query of individual Nodes one by one [18]. Of course, the whole is automatically encrypted using AES-128 encryption. TR is not controlled by an application program but from the control system via SPI (Serial Peripheral Interface) or UART by the DPA protocol. All resources of the addressed device are accessed via sending requests and receiving responses. Requested functionality is achieved without programming.

Two network types are available:

- STD network: Only STD Nodes are allowed. The network is faster (thanks to the shorter time slot per hop).
- STD+LP network: STD Nodes as well as LP Nodes are allowed. The network is about two times slower (due to the longer time slot per hop).

The network type is selected in the TR configuration of the Coordinator. The routing is based on directional flooding of the network and TDMA (Time Division Multiple Access).

The IQMESH® protocol rules are as follows:

- every discovered Node in the network can route packets in the background,
- such routing can be turned off (in the TR configuration of the given Node),
- every Node routes every packet only once,
- every Node routes in the time slot corresponding to its VRN address (assigned during the Discovery), the response passes in the reverse order,
- routing Nodes should not be moved (static routing backbone), after relocating a routing Node, the Discovery should be re invoked,
- topology (placement of devices with respect to the range) should be designed redundantly (every Node should have a sufficient number of other Nodes in range),
- IQMESH® supports communication between the Coordinator and a Node only (but not directly between the Nodes).

Synchronous communication is recommended: requests are initiated by the Coordinator and responses are sent from Nodes. IQMESH® network is controlled by the DPA protocol from a control system connected to the Coordinator via the SPI or UART interface. The communication in IQMESH is primarily intended as the synchronous one: Request – Response [18].

Fig. 5 shows how the DPA remote communication with the Node works (via the Coordinator, wirelessly):

- control system sends a DPA Request to the given Node,
- Coordinator returns a DPA Confirmation,
- Node returns a DPA Response.

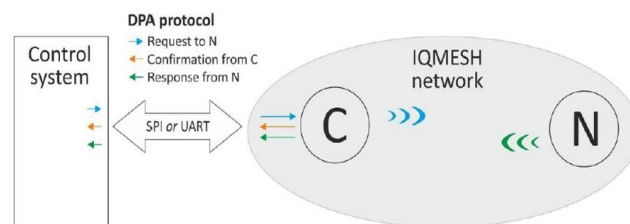

Fig. 5. The principle of communication between the microcontroller, coordinator C and node N [18]

### III. ARRANGEMENT OF MESH NETWORK IN THE BUILDING

The article presents the design and practical implementation of a radio mesh network. The radio modules of the IQRF® system were used to build the network. The configuration and construction of the network was made in the IQRF® IDE4 system environment to work in the ISM 868 MHz band. As part of the work, the properties of the mesh network were examined. The network nodes are radio modules enabling remote temperature measurement. They were located on several floors and in different rooms of the P3 building of the Opole University of Technology. By appropriately setting the parameters of the radio modules, it was possible to examine different mesh topology configurations. The study of communication between individual nodes and the coordinator was carried out by sending a request for temperature reading to individual nodes. It enables measurement of transmission delay time and received power. The received power level in individual nodes was determined for different power levels of the transmitted signal and different distance of the given node from the coordinator.

The modules are arranged in rooms on individual floors:

- basement, room 026 - node 9,
- ground floor, room 119 - node 8, room 109B - node 7,
- concierge (ground floor), - node 6,
- first floor, room 222 - node 5,
- second floor, room 308 - node 1, room 311 - node 2, room 313 - node 3, room 309 - node "coordinator",
- third floor, room 412 - node 4.

Modules with IQRF® transmitters were located in central places of rooms in the P3 building at a height of 1.5 m. The locations of individual modules (marked in blue) in the building structure are shown in Fig. 6.

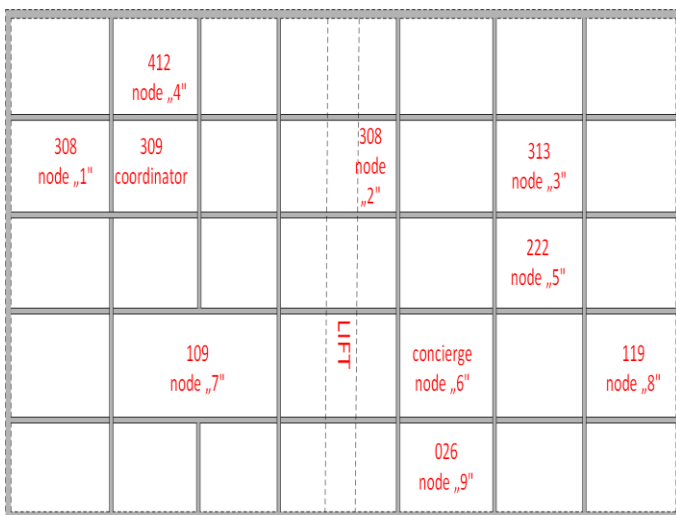

Fig. 6. A simplified schematic diagram of the P3 building with the arrangement of modules on floors, view from Pruskowska Street

An IQRF® network is a type of telecommunications infrastructure that uses wireless connections between nodes. The type of terrain, buildings, weather, as well as the presence of other transmitters can generate radio wave interference and attenuation. That has a huge impact on the quality and range of transmission. The propagation conditions in the building are much worse. The greatest impact on radio wave attenuation in

the building is the thickness and number of walls / ceilings. The wall material also affects wave propagation. Some objects inside the building can cause diffraction of radio waves, they can absorb their energy and cause reflections. All these factors are taken into account when calculating and predicting network coverage, because they have a real impact on wave propagation and increase radio wave attenuation. To describe propagation phenomena in the indoor environment, the following models were often used: One-Slope, Motley-Keenan, Multi-Wall, 3D Ray Tracing, Model ITU-P.1238 [19 - 21]. Radio coverage simulations were performed using the WinProp package [22], which allowed the assessment of the possibility of proper transmission in the mesh network in the P3 building environment [23].

An example of the simulation for the Motley-Keenan model, for transmitter output signal power (EIRP) 7 dBm and frequency 868 MHz is shown in Fig. 7 [23]. Based on the simulations carried out, it can be concluded that the radio coverage in the building is at the right level for  $\frac{1}{4}$  of the building space near the signal transmitter. The signal strength then reaches a value above the threshold sensitivity of the receiver of - 101 dBm. To ensure the operation of the radio network throughout the building, a mesh solution is needed that provides greater transmission range by the several hops on the route between the coordinator and the nodes.

To create the first network topology, the following network parameters were set. The fixed parameter is "RX filter" = 5. It is responsible for the input signal filtration. Some applications may require a shorter range to maintain the best signal-to-noise ratio [17]. In this case, shortening the range should be achieved mainly by input filtration, not by reducing the output power.

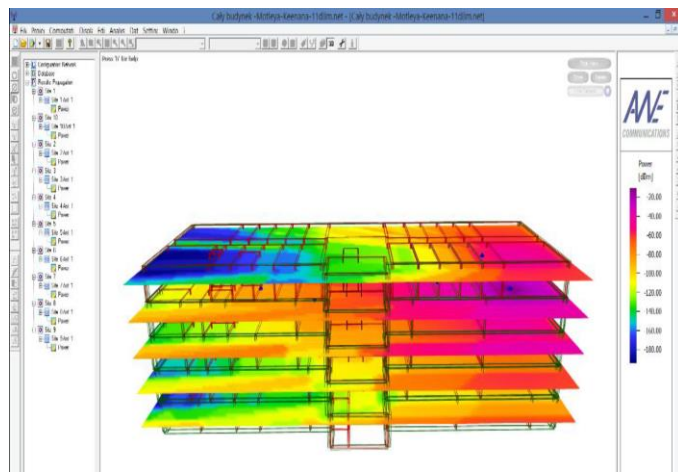

Fig. 7. The result of the radio coverage simulation in P3 building for the Motley-Keenan model, the chosen transmitter is the node 1 (2nd floor - room No. 308) [23]

In this network design the "RX filter" = 5 and this parameter will be kept constant, while "TX power" will be changed in the range from 1 to 7. For the first topology the "TX power" = 1. Subsequent changes to this parameter will create other network topologies. It is an automated process controlled by the IQMESH® protocol.

After the network is created, the transmission parameters will be measured. One of them is RSSI. The TR module has an implemented function that enables measurement of the RSSI

(Received Signal Strength Indication) level. This is an indicator of the level of signal received by the wireless device, including interference and noise, which increase the RSSI level [17]. The indicator level is recorded as the value of the RSSI parameter. If the RSSI value is increasing, then the received signal power is also increasing. In order to obtain the RSSI value, the built-in functionality of the IQRF<sup>®</sup> system was used, which enables the measurement of this parameter. After successful creation of the network, the system automatically measures RSSI values, thanks to which we can easily read and analyse them.

The next parameter tested will be RTT (Round Trip Time), i.e. the transmission delay time. The temperature measurement from the sensor built into the DK-EVAL module was used here. For this purpose, a "Terminal" was used, from which a temperature reading command was sent for specific nodes, followed by readings in the "Terminal log" panel. The software does not provide RTT time directly, but records the query and response times from which RTT can be calculated. A reading from the TR -72DA module will be used for this. The reading consists of sending "Request", accepting "Confirmation" and receiving "Response". From the received data, RTT time will be determined for different network topologies and for different transmitter output signal power values. The measured average values (for 10 measurements) of the RSSI and RTT parameters are shown in the Table I and Table II. The table fields are not filled if RSSI was below the threshold of sensitivity.

ΔTime	Rx/Tx	Length	Data HEX	DPA Me...
N/A	Tx	6	01.00.0A.00.FF.FF.	Request
00:00:00.016	Rx	11	01.00.0A.00.FF.FF.FF.3C.01.08.01.	Confirmation
00:00:00.218	Rx	11	01.00.0A.80.0F.00.00.44.18.85.01.	Response

Fig. 8. A single temperature reading cycle, ΔTime means the duration of the operation

The second parameter measured was RTT. The temperature measurement from the sensor built into the DK-EVAL module was used here. For this purpose, a "Terminal" was used, from which a temperature reading command was sent for specific nodes, followed by readings in the "Terminal log" panel. The environment does not provide RTT time directly, but records the query and response times from which RTT can be calculated.

TABLE I  
SUMMARY OF RSSI VALUES FOR ASSUMED "TX POWER"

	Node	TX power = 1/2	TX power = 3	TX power = 4	TX power = 7
RSSI [dBm]	1	-55	-63	-65	-71
	2		-87	-96	-85
	3		-95	-95	-93
	4	-64	-76	-68	-62
	5		-99	-96	-94
	6		-97	-96	-96
	7		-83	-85	-79
	8		-94	-92	-97
	9		-98	-101	-97

TABLE II  
SUMMARY OF RTT VALUES FOR ASSUMED "TX POWER"

	Node	TX power = 1/2	TX power = 3	TX power = 4	TX power = 7
RTT [ms]	1	190	265	234	259
	2		380	482	323
	3		800	700	401
	4	302	334	304	485
	5		733	792	570
	6		721	723	642
	7		574	403	720
	8		900	1059	801
	9		1212	1034	964

IV. NETWORK TOPOLOGY FOR "TX POWER" = 1 AND "TX POWER" = 2

The first network topology was created for "Power TX" = 1. This is the minimum transmit power for which IQMESH Network Manager provided connectivity between the coordinator and the nodes. According to fig. 5, for "TX Power" = 1 the 10% of transmitter output signal power is obtained. Only the two closest nodes were able to connect.

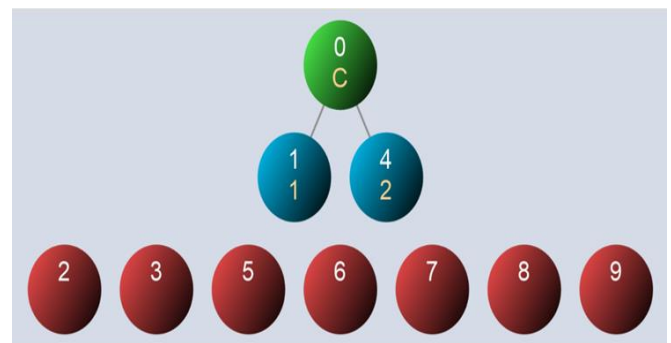

Fig. 9. Network topology for "TX Power" = 1 or 2

The first node is located in room no 308, it is the room adjacent to room 309, in which the coordinator is. The node 4 is placed in room no 412, it is the room on the first floor above, directly above room 309. We can see that RSSI for node 4 is -64 dBm, for comparison for node 1 is -55 dBm. The node 1 is the closest to the coordinator. Figure 9 shows the network topology diagram created in IQMESH Network Manager. This is a typical star topology. Other nodes (numbers: 2, 3, 5, 6, 7, 8, 9) were not able to establish a connection with the coordinator for "TX Power" = 1, because the measured RSSI value was below the threshold of sensitivity. A query was sent to individual nodes, the delay time was examined and RTT was determined. The environment of IQMESH<sup>®</sup> Network Manager measures ΔTime for query, confirmation and feedback. These values are added together and summarized in Table II. For RSSI values, a summary is shown in Table I. Similar results were obtained for "TX Power" = 2.

V. NETWORK TOPOLOGY FOR "TX POWER" = 3

This chapter will describe the mesh network created for the "TX power" = 3. The new topology is more extensive. There

are three zones in which the nodes connect. A local star is formed in the first zone then another three nodes from the second zone join the node 7, which creates another local star topology. Combining everything together creates the resulting mesh network, the topology of which is shown in Fig. 10.

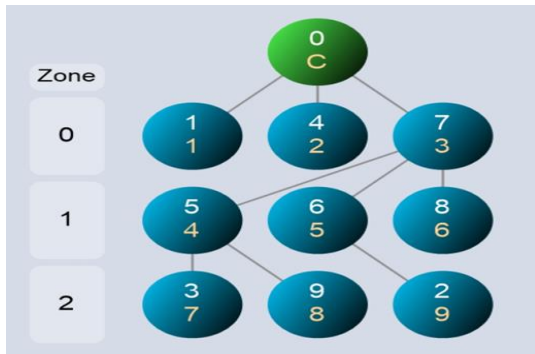

Fig. 10. Network topology for "TX Power" = 3

The measured RSSI values are summarized in Table I, and then the characteristics of RSSI dependence on the node number are plotted (Fig. 11). For "TX Power" = 3, the coordinator has connected to all nodes. In the first zone, it is connected with node 1, node 4 and node 7. These are rooms 308 (node 1), 412 (node 4) and 109B (node 7) mentioned above. Room 109B is on the ground floor, two floors below. Connections to node 7 are used by nodes 5, 6 and 8, i.e. rooms 222, porter's lodge and room 119. The last nodes (3, 9 and 2) are placed in rooms 313, 026 and room 311.

The RTT was the second parameter measured. A request for temperature measurement was sent to each node. The determined RTT values are summarized in Table II. A plot of RTT dependence on the node number was plotted from the collected data (Fig. 12). After comparing the RTT measurement results and comparing the RSSI and RTT charts, it was noticed that as the RSSI power of the received signal decreases, the transmission time of the RTT information increases. For the node 1: RSSI= -63 dBm, RTT = 249 ms, for the node 4: RSSI = -76 dBm, RTT = 334 ms and for node 8: RSSI = -94 dBm, RTT = 900 ms. This can be seen in the charts below.

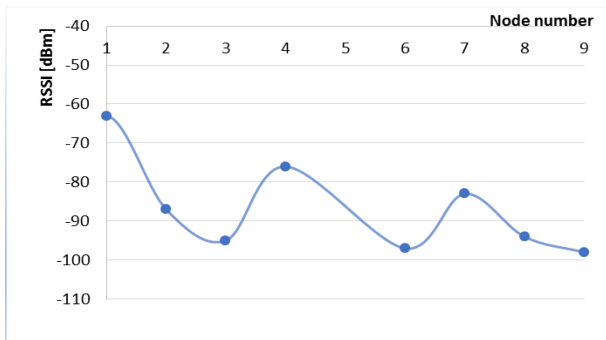

Fig. 11. RSSI versus node number, TX Power=3

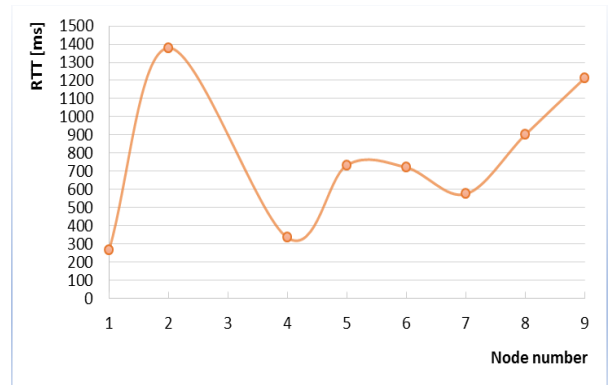

Fig. 12. RTT versus node number, TX Power=3

### VI. NETWORK TOPOLOGY FOR "TX POWER" = 4

A topology with two zones was created (Fig. 13). The distribution of the number of nodes in individual zones is as follows: three nodes in the first zone (designation: zone "0") and 6 nodes in the second zone (designation: zone "1").

For the "TX power" = 4, the signal strength is sufficient to obtain the coordinator's connection to the furthest node using only one node along the way. It is node 7, which is directly connected to the coordinator. The transmitter output signal power for this topology corresponds to about 50% of the relative range of the TR module. Node 7 has become the main access point for five other nodes. Node 2 is connected automatically via node 1. RSSI values range from -101 dBm to -65 dBm. The nearest point has a lower RSSI value for "TX Power" = 4 than for "TX Power" = 3.

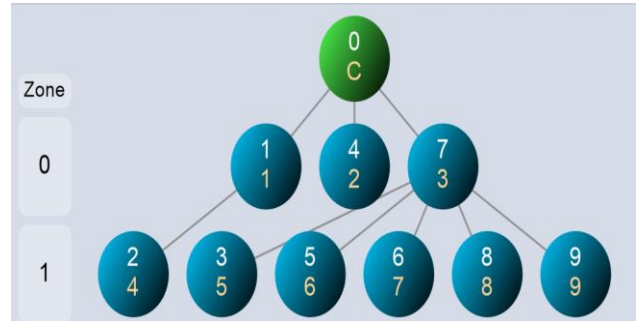

Fig. 13. Network topology for "TX Power" = 4

It is the result of the mechanism using the "RX filter" parameter settings. Then RTT was measured. As with previous topologies, the temperature reading was used. The shortest RTT time recorded is 234 ms, the longest is 1034 ms. The data are summarized in Table II and graphs showing the relationship between RSSI and RTT relative to the node number (Fig. 14 and 15) are presented. As RSSI decreases, RTT increases. For various network topologies, the shape of the chart of RSSI and RTT dependence on the node location (for "TX Power" = 4 and TX Power "= 3) is very similar despite the nodes being connected by different intermediate nodes.

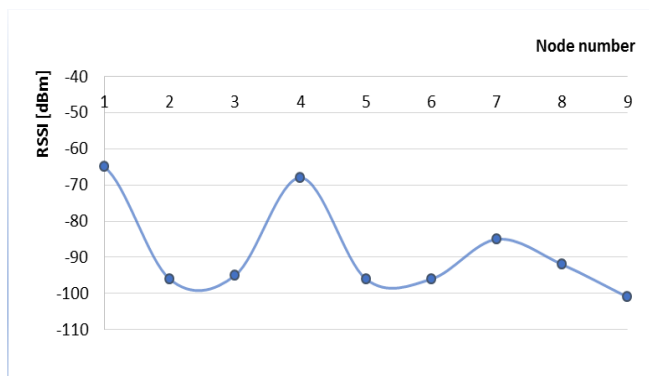

Fig. 14. RSSI versus node number, TX Power=4

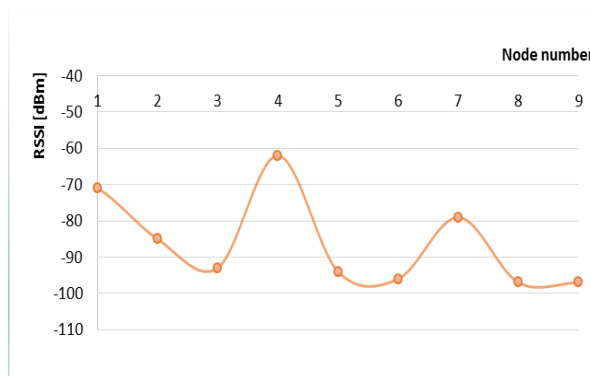

Fig. 17. RSSI versus node number, TX Power = 7

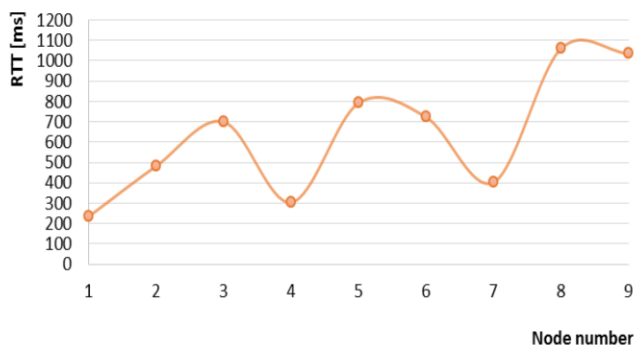

Fig. 15. RTT versus node number, TX Power=4

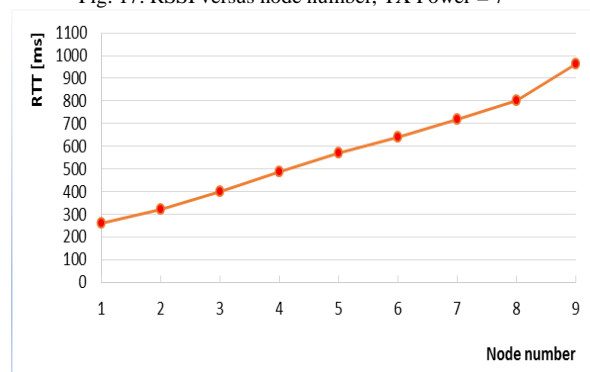

Fig. 18. RTT versus node number, TX Power = 7

VII. NETWORK TOPOLOGY FOR "TX POWER" = 7

The last chapter related to the auto configuration of the new network topology discusses the topology obtained for the maximum power "TX power" = 7. The arrangement of nodes is significantly different from the other topologies. As many as seven out of nine nodes were connected directly to the coordinator (Fig. 16). The other two nodes were assigned to the second zone. The RSSI results are summarized in Table I, and then the characteristics of RSSI dependence on the node number are plotted (Fig. 17).

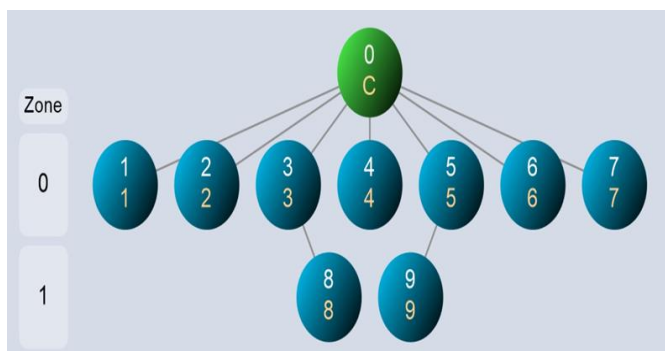

Fig. 16. Network topology for "TX Power" = 7

For nodes number 8 and 9, the lowest RSSI value = -97 dBm was obtained. They are located 2 floors below the coordinator. RSSI values change in the range -97 dBm to -62 dBm.

The RTT was the second measured parameter. The determined RTT values are summarized in Table II. From the collected data, the graph of RTT dependence on the node number was determined (Fig. 18).

RTT values varying between 259 ms and 964 ms have been measured. The RTT dependence on the node number for "TX Power" = 7 is linear and this is a significant change compared to previous results. For each previous topology, the appearance of RSSI and RTT dependence on the node number was similar, and the increase in RSSI value corresponded to a decrease in RTT value. Graphs were made of RSSI, RTT and throughput relative to the number of walls / ceilings on the transmission route. Figures 19, 20, 21 shows two data series for "TX Power" = 4 and "TX Power" = 7.

The nominal RF data transmission bit rate for TR-72DAT is 19.8 kb/s. The actual (instantaneous) throughput (THR) on the route coordinator - node was determined on the basis of the formula (1).

$$THR = \frac{n \cdot 32}{t} \left[ \frac{bit}{s} \right] \tag{1}$$

where:

- n - number of packets,
- t - time needed to receive packets (Response time) [s].

The size of one packet is 32 bits, the number of packets for the tested single transmission was 11. The obtained results are shown in Fig.23. The values of throughput are lower than the nominal value of bit rate, as the instantaneous transmission capacity for specific terrain conditions is determined taking into account the delay caused by hops between nodes and thus longer transmission time. The calculated bandwidth of the link decreased along with the increase in the number of walls, both for "TX Power" = 4 and "TX Power" = 7. For "TX Power" = 7 the decrease was much smaller, this is due to the increase in the power of the transmitted signal. Similar relationships were observed for RSSI and RTT. As the number of walls is

increased, RSSI values are decreased and RTT values are increased. For a number of walls less than 6, the throughput value is greater than 400 b / s, which is satisfactory. From the above tests, it is recommended that the number of walls / ceilings be lower than 7.

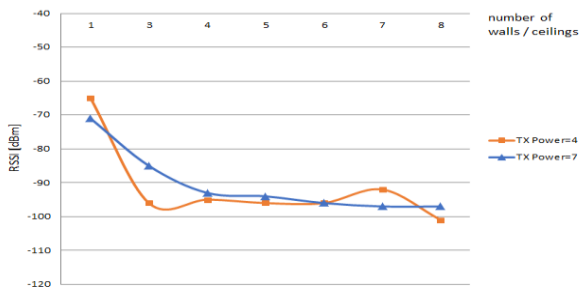

Fig. 19. RSSI versus number of walls / ceilings.

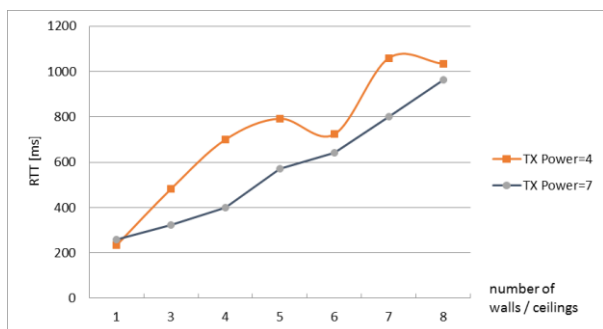

Fig. 20. RTT versus number of walls / ceilings.

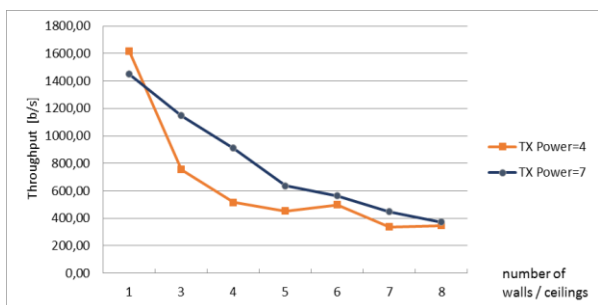

Fig. 21. Throughput versus number of walls / ceilings.

## CONCLUSION

The main purpose of the work was to build a measurement/sensor mesh network. Despite several technical problems, it was possible to correctly design the network using IQRF<sup>®</sup> radio modules. Nine TR modules forming the nodes and one module being the coordinator permanently connected to the computer were used for this. According to the assumptions, the modules were placed in building P3 of the Opole University of Technology. This was done on each floor to check network coverage. RSSI and RTT measurements were carried out to investigate network performance. The best results were obtained for "TX Power" = 7. According to predictions, most nodes established a direct connection with the coordinator. For "TX Power" = 1 and "TX Power" = 2, only two nodes are connected with the coordinator. The IQRF<sup>®</sup> IDE4 system has already connected to all nodes and has created a typical mesh network with three zones for "TX Power" = 3. All nodes were connected using two zones for

"TX Power" = 4. A relationship between RSSI value and RTT value was observed. For each topology (except for that obtained for "TX Power" = 7), as the RSSI value decreased, the RTT time value increased.

IQRF<sup>®</sup> radio module technology is a modern alternative to other industrial technologies. The biggest advantage of this solution is very low power consumption as well as obtained network coverage. In addition to several energy saving modes and a large range, the IQRF<sup>®</sup> feature is the ability to create an extensive network structure supporting a large number of nodes. Such a feature is strongly desirable nowadays, with a constantly increasing number of connections between devices. This significantly facilitates network expansion, and the FRC protocol facilitates the collection of data from a large number of nodes in a short time.

## REFERENCES

- [1] IEEE Internet of Things [https://iot.ieee.org/].
- [2] IEEE standards IoT [http://standards.ieee.org/innovate/iot/stds.html].
- [3] K. Holger, A. Wilig, "Protocols and Architectures for Wireless Sensor Networks," John Wiley Sons, Ltd., 2005.
- [4] I. F. Akyildiz, W. Su, Y. Sankarasubramaniam, E. Cayirci, "Wireless Sensor Networks: a Survey," *Computer Networks*, Vol. 38, 2002, pp. 393-422.
- [5] I. F. Akyildiz, T. Melodia, and K. R. Chowdhury, "A survey on wireless multimedia sensor networks", *Comput. Networks*, vol. 51, no. 4, pp. 921960, 2007.
- [6] J. N. Al-Karaki, E. Kamal, "Wireless Sensor Networks Routing Techniques in Wireless Sensor Networks: A Survey", *IEEE Wireless Commun.*, vol. 11, no. December, pp. 628, 2004.
- [7] G. Aggelou, *Wireless Mesh Networking*, McGraw-Hill Communications, 2008.
- [8] Y. Zhang, J. Luo, H. Hu, *Wireless Mesh Networking*, Auerbach Publications, 2007
- [9] Ekram Hossain, *Wireless Mesh Networks: Architectures and Protocols*, Springer, 2007
- [10] Yan Zhang, Jijun Luo, Honglin Hu, 2007, "Wireless Mesh Networking - Architectures, Protocols and Standards", © 2007 by Taylor & Francis Group
- [11] Jun Huy Lam, Sang-Gon Lee, Whye Kit Tan, 2012, "Performance Evaluation of Multi-Channel Wireless Mesh Networks with Embedded Systems", *Sensors (Basel)*. 2012; 12(1): 500–517.
- [12] S. M. Darroudi and C. Gomez, "Bluetooth Low Energy Mesh Networks: A Survey," *Sensors*, vol. 17, no. 7, 2017. [Online; accessed 20-Dec-2019]. [Online]. Available: <http://www.mdpi.com/1424-8220/17/7/1467>.
- [13] Specification, ZigBee Alliance. ZigBee Document 053474r06, Version, 2006.
- [14] Microrisc, [Online; accessed 20-Dec-2019]. [Online]. Available: <https://www.microrisc.com/en>.
- [15] IQRF Technology, [Online; accessed 20-Dec-2019]. [Online]. Available: <https://iqrftech.com/iqrftech/www/en/technology>.
- [16] IQRF Alliance, <https://www.iqrfalliance.org/index.php>
- [17] TR-72D RF Transceiver Module Series Data Sheet, [Online; accessed 20-Dec-2019]. [Online]. Available: <https://www.iqrf.org/products/transceivers/tr-72d>.
- [18] IQMESH Network Deployment For IQRF OS v4.03 and DPA v4.02 Technical Guide, [Online; accessed 20-Dec-2019]. [Online]. Available: <https://www.iqrf.org/technology/dpa/dpa-sw-documentation>.
- [19] L. W. Barclay, Ed., *Propagation of radio waves*, 3rd ed. London, UK: The Institution of Engineering and Technology, 2012.
- [20] R. Vaughan and J. Bach Andersen, *Channels, propagation and antennas for mobile communications*. London, UK: Institution of Engineering and Technology, 2003.
- [21] S. Salous, *Radio propagation measurement and channel modelling*. Hoboken, NJ, USA: Wiley, 2013.
- [22] WinProp, [Online; accessed 20-Dec-2019]. [Online]. Available: <https://altairhyperworks.com/product/feko/winprop-propagation-modeling>.
- [23] J. Mnich, "Modeling of propagation of electromagnetic waves in a wireless mesh network using a WinProp package", Diploma thesis. Thesis supervisor: S Pluta. Opole University of Technology. 2020