



## EVALUATION OF LIQUID-GAS FLOW IN PIPELINE USING GAMMA-RAY ABSORPTION TECHNIQUE AND ADVANCED SIGNAL PROCESSING

Robert Hanus<sup>1)</sup>, Marcin Zych<sup>2)</sup>, Volodymyr Mosorov<sup>3)</sup>, Anna Golijanek-Jędrzejczyk<sup>4)</sup>, Marek Jaszczur<sup>5)</sup>, Artur Andruszkiewicz<sup>6)</sup>

1) Rzeszów University of Technology, Faculty of Electrical and Computer Engineering, Powstańców Warszawy 12, 35-959 Rzeszów, Poland (✉ [rohan@prz.edu.pl](mailto:rohan@prz.edu.pl), +48 17 743 2463)

2) AGH University of Science and Technology, Faculty of Geology, Geophysics and Environmental Protection, Al. Mickiewicza 30, 30-059 Kraków, Poland ([zych@geol.agh.edu.pl](mailto:zych@geol.agh.edu.pl))

3) Łódź University of Technology, Institute of Applied Computer Science, Żeromskiego 116, 90-537 Łódź, Poland ([mosorow@kis.p.lodz.pl](mailto:mosorow@kis.p.lodz.pl))

4) Gdańsk University of Technology, Faculty of Electrical and Control Engineering, Narutowicza 11/12, 80-233 Gdańsk, Poland ([anna.golijanek-jedrzejczyk@pg.edu.pl](mailto:anna.golijanek-jedrzejczyk@pg.edu.pl))

5) AGH University of Science and Technology, Faculty of Energy and Fuels, Al. Mickiewicza 30, 30-059 Kraków, Poland ([jaszczur@agh.edu.pl](mailto:jaszczur@agh.edu.pl))

6) Wrocław University of Science and Technology, Faculty of Mechanical and Power Engineering, Wybrzeże Wyspiańskiego 27, 50-370 Wrocław, Poland ([artur.andruszkiewicz@pwr.edu.pl](mailto:artur.andruszkiewicz@pwr.edu.pl))

### Abstract

Liquid-gas flows in pipelines appear in many industrial processes, e.g. in the nuclear, mining, and oil industry. The gamma-absorption technique is one of the methods that can be successfully applied to study such flows.

This paper presents the use of the gamma-absorption method to determine the water-air flow parameters in a horizontal pipeline. Three flow types were studied in this work: plug, transitional plug-bubble, and bubble one. In the research, a radiometric set consisting of two Am-241 sources and two NaI(Tl) scintillation detectors have been applied. Based on the analysis of the signals from both scintillation detectors, the gas phase velocity was calculated using the cross-correlation method (CCM). The signal from one detector was used to determine the void fraction and to recognise the flow regime. In the latter case, a Multi-Layer Perceptron-type artificial neural network (ANN) was applied. To reduce the number of signal features, the principal component analysis (PCA) was used. The expanded uncertainties of gas velocity and void fraction obtained for the flow types studied in this paper did not exceed 4.3% and 7.4% respectively. All three types of analyzed flows were recognised with 100% accuracy. Results of the experiments confirm the usefulness of the gamma-ray absorption method in combination with radiometric signal analysis by CCM and ANN with PCA for comprehensive analysis of liquid-gas flow in the pipeline.

Keywords: two-phase flow, void fraction, gamma-ray absorption, flow regime identification, artificial neural network.

© 2021 Polish Academy of Sciences. All rights reserved

## 1. Introduction

Two-phase liquid-gas flows often occur in technology, *e.g.* in the chemical, petrochemical and mining industries as well as in environmental and energy engineering. This type of flow is particularly important in many devices, such as reactors and bioreactors, heat exchangers, and absorption, rectification and distillation columns. The method and parameters of gas-phase transport by a liquid in liquid-gas flow are often very important because they affect the course of technological processes.

It is known that flows with the gas phase are difficult to describe mathematically [1]. For this reason, experimental research and development of existing and new methods are highly desirable. Currently, measurements of liquid-gas flows can be performed using tomographic methods (resistivity, optical, capacitance, X-ray and  $\gamma$ -ray tomography) [1–6], Coriolis flow meters, *Particle Image Velocimetry* (PIV), *Laser Doppler Anemometry* (LDA), high-speed cameras, magnetic resonance imaging and radioisotope methods [7–10]. The latter, especially the  $\gamma$ -ray absorption method, are also utilised by the authors of this paper in the evaluation of two-phase liquid-solids and liquid-gas flows [11–14]. Other scientific teams use radioisotope methods to study the flow of liquids [15–17] and various multiphase mixtures [18–20].

Signals from scintillation detectors in a radiometric measurement set can be applied to determine the velocity of the dispersed phase and other important flow parameters, *e.g.* void fraction and the rate of dispersed-phase flow. The measurements using gamma absorption are non-invasive, have a simple basis and are relatively accurate. They allow to simultaneously determine the velocity of the gas-phase and the void fraction using the same equipment. The disadvantages of this method include radiological risk and a relatively high cost.

This paper investigates the application of a radiometric set consisting of two Am-241 gamma radiation sources and two NaI(Tl) scintillation detectors to two-phase liquid-gas flow in a horizontal pipeline. With this set, it is possible to designate the average velocity of the gas phase, void fraction and to identify the regime of the flow. Section 2 describes the laboratory set-up and the principle of the gamma-absorption method. Section 3 presents the processing of signals obtained from scintillation detectors by using the *cross-correlation method* (CCM) to determine the average velocity of the gas-phase. Section 4 discusses the procedures for void fraction evaluation. In Section 5, there is described identification of the flow regime using a *Multi-Layer Perceptron* (MLP)-type *artificial neural network* (ANN) in combination with *principal component analysis* (PCA). Section 6 contains a summary and conclusions from the conducted research.

This paper is a significantly extended version of conference publications [21, 22] and summarises the authors' work on liquid-gas flow evaluation using the gamma absorption method.

## 2. Experimental installation and measurement principle

In this research studies, experimental data acquired for a hydraulic installation, constructed at the AGH University of Science and Technology in Kraków (Poland) are presented. A diagram of the laboratory installation is presented in Fig. 1.

The main part of the installation consists of a 4.5 m long horizontal plexiglas transparent pipe of inner diameter  $D = 30$  mm. The water from the pump (5) is fed to the pipeline with gas from the compressor (6) through a gas nozzle (8). The water-air mixture flowing through the horizontal measuring section of the pipe forms two-phase and enters the gas-removing tank (7). The flow parameters can be calculated using signals from radiometric sets and appropriate data analysis software "Convolution". Each set includes a radiation source X.103 (AEA Technology QSA)

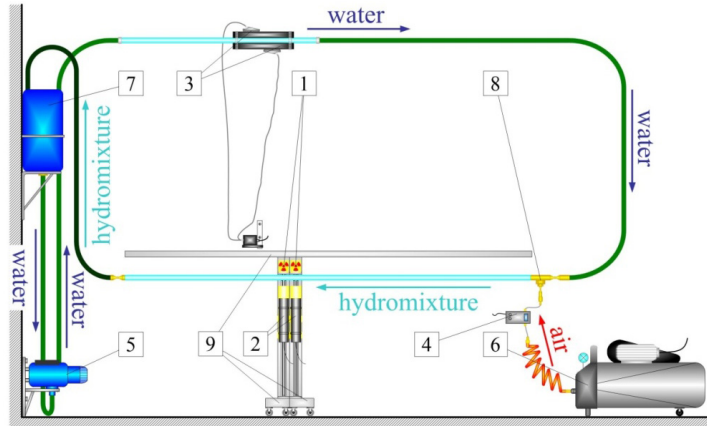

Fig. 1. Diagram of the experimental set-up: 1 – sealed radioactive source; 2 – scintillation probe; 3 – ultrasound flow meter; 4 – mass flow meter of air, 5 – pump with power inverter, 6 – compressor, 7 – gas-removing tank, 8 – gas nozzle, 9 – source and probe shifting system [12].

(1) with an energy of 59.5 keV and activity of 100 mCi, and a NaI(Tl) scintillation detector (2) type SKG-1 (TESLA). The shifting system (9) allows sliding of the radiometric sets (sources and probes) along the pipe. The measurement setup also includes a Uniflow 990 ultrasound flowmeter (3) and a Brooks 4800 air mass flowmeter and controller (4) for liquid and gas phase flow control. In the installation, it is possible to obtain a water flow velocity the range from 0.5 m/s to 2.5 m/s. For data acquisition, a counter card connected to PC was used. In addition, a Panasonic NV-GS75 video camera was used for recording the flow structures. A view of the measurement section of the installation is shown in Fig. 2.



Fig. 2. A view of the measurement section of the installation.

With appropriate pump settings and air dosing from the compressor, different flow structures can be obtained in the pipeline measuring section [12, 13]. Three examples of such structures analysed in this work: plug, transitional plug-bubble, and bubble are presented in Figs. 3a–3c.

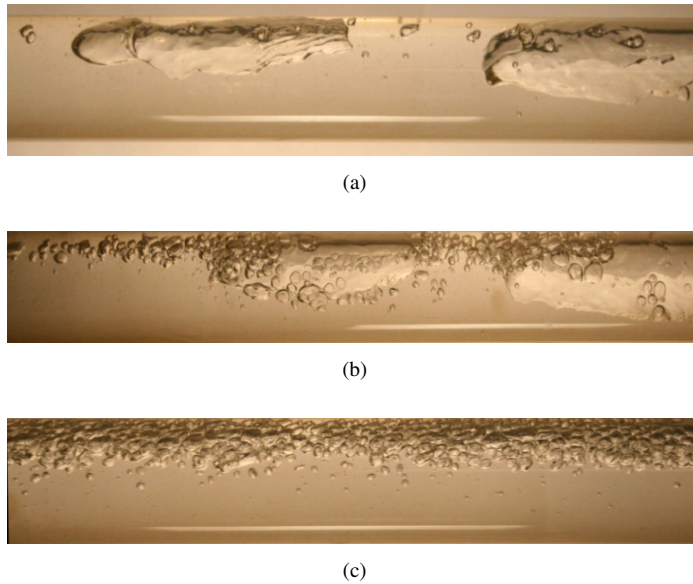

Fig. 3. Examples of analysed liquid-gas flow structures: (a) plug flow, (b) transitional plug-bubble flow, (c) bubble flow.

The radioisotope method of measurement of gas transport parameters is based on the absorption of gamma rays by the flowing two-phase mixture. The phenomenon of gamma radiation absorption by matter is described by the Lambert–Beer principle. The output radiation intensity  $I$  is calculated from the equation:

$$I = I_0 \exp(-\eta\mu x), \quad (1)$$

where:  $I_0$  – intensity of input radiation,  $\eta$  – density of absorbent,  $\mu$  – gamma-ray mass attenuation coefficient,  $x$  – thickness of absorbent material.

When the basic expression (1) is applied to a mixture of gas and liquid, the corresponding equation is:

$$I = I_0 \exp[-(\eta_L \mu_L x_L + \eta_G \mu_G x_G + \eta_P \mu_P x_P)], \quad (2)$$

where subscripts  $L$  and  $G$  and  $P$  denote the liquid, gas and pipe wall respectively.

The principle of measurement of liquid-gas mixture flow in the horizontal pipeline with the gamma-ray absorption method is presented in Fig. 4.

Two sources of gamma radiation (2), placed at distance  $L = 97$  mm, emit  $\gamma$  – radiation beams (5) shaped by collimators (1). Photons pass through liquid-gas mixture in the pipeline (5). Two scintillation probes (4) are equipped with collimators (3). Detectors are placed at the same distance  $L$  from each other as the sources on the opposite side of the pipe. The distance between the probes was selected experimentally to obtain a visible maximum of the cross-correlation function (CCF) and to avoid interference from the scattered gamma-ray beams from both sources. Count signals  $I_x(t)$  and  $I_y(t)$  are registered at the outputs of the first and second detector, respectively.

The sequences of voltage pulses  $I_x(t)$  and  $I_y(t)$  are counted during sampling interval  $\Delta t = 1$  ms and giving discrete signals  $x(n)$  and  $y(n)$ ,  $n = \text{int}(t/\Delta t)$ . The exemplary records of  $x(n)$  signals, acquired for the plug flow, transitional plug-bubble flow, and bubble flow are presented in

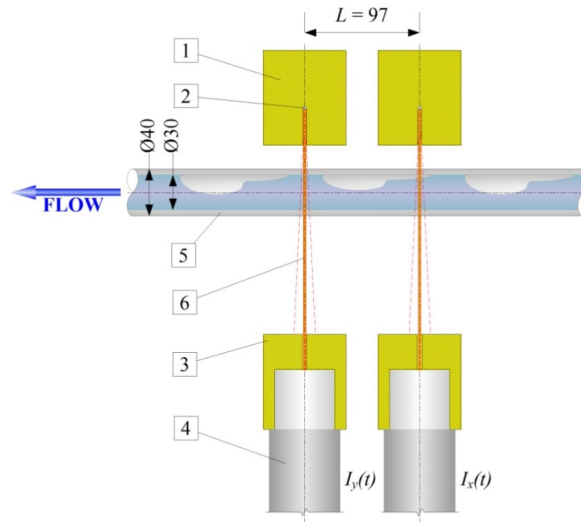
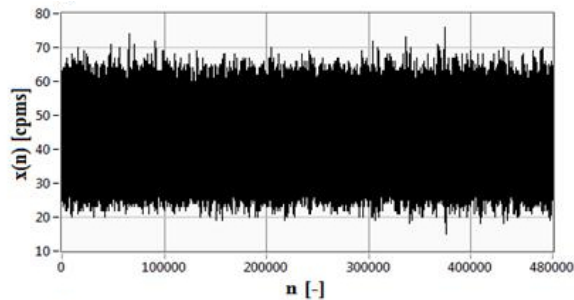
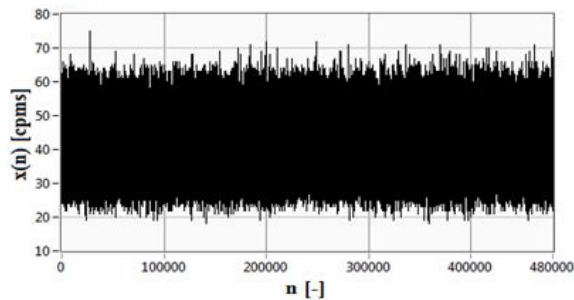

Fig. 4. The idea of measurement of liquid-gas flow in the pipeline using the gamma-ray absorption method: 1 – collimator of the radioactive source, 2 – linear radioactive source, 3 – collimator of the detector, 4 – scintillation detector, 5 – pipe, 6 – main  $\gamma$  – radiation beam [27]. Dimensions are given in mm.

Figs. 5a–5c respectively. By analysing these signals it is possible to determine several different flow parameters, *e.g.* average dispersed phase velocity, the void fraction (possible due to the calibration for a given medium), as well as identifying the flow regime.



(a)



(b)

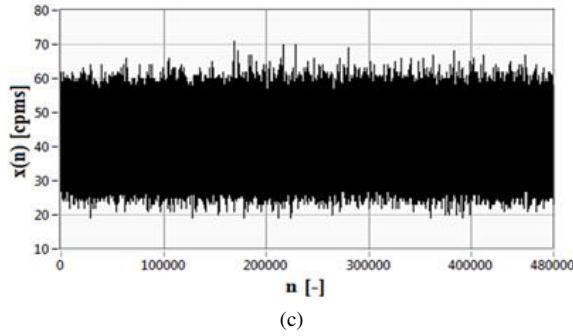

Fig. 5. Examples of signals  $x(n)$  for (a) plug flow, (b) plug-bubble flow, and (c) bubble flow.

### 3. Calculation of gas-phase average velocity

The signals obtained from the scintillation detectors in the measurement of the liquid-gas flow are mutually delayed stochastic waveforms. Statistical methods are usually used to analyse these signals.

Average gas phase velocity  $v_G$  is calculated from the following equation:

$$v_G = \frac{L}{\hat{\tau}_0}, \quad (3)$$

where  $\hat{\tau}_0$  is a time delay estimator which can be calculated with the CCM, phase or other methods [13, 23, 24].

Through the use of the most known CCM, the transportation time  $\hat{\tau}_0$  is usually determined based on the position of the global waveform maximum of the CCF  $R_{xy}(\tau)$ , which can be calculated using equation (4) [23]:

$$R_{xy}(\tau) = \frac{1}{N} \sum_{n=0}^{N-1} x(n)y(n+\tau), \quad (4)$$

where:  $N$  is the number of samples of the signal (in the presented studies,  $N = 480\,000$ ),  $\tau$  is the time delay.

Figures 6a–6c show samples of cross-correlation functions obtained for the plug, transitional plug-bubble, and bubble flow. It can be seen that for the CCFs shown in these figures it is difficult clearly determine the position of the main maximum, especially for the bubble flow (Fig. 6c). For this reason, smoothing of the calculated CCF or additional signal preprocessing before correlation analysis is highly required. This issue is thoroughly discussed in [25]. Figures 6d–6f show CCFs achieved by band-pass digital filtering of the  $x(n)$  and  $y(n)$  signals. The pass-bands  $f_{BP}$  were selected individually for each analysed signal:  $f_{BP} = (0.1–17.0)$  Hz for plug flow,  $f_{BP} = (0.1–45.0)$  Hz for plug-bubble flow and  $f_{BP} = (0.1–50.0)$  Hz for bubble flow [25].

One can infer from Fig. 6 that the signal filtering greatly facilitates the location of the maximum CCFs and determination of transportation time delay  $\hat{\tau}_0$ . The dispersed phase flow velocities are calculated using (3). Following the law of propagation of uncertainty [26], the combined standard uncertainty  $u_c(v_G)$  of the gas phase velocity can be determined from the formula:

$$u_c(v_G) = \sqrt{\left(\frac{\partial v_G}{\partial L}\right)^2 u_B^2(L) + \left(\frac{\partial v_G}{\partial \hat{\tau}_0}\right)^2 u_A^2(\hat{\tau}_0)}, \quad (5)$$

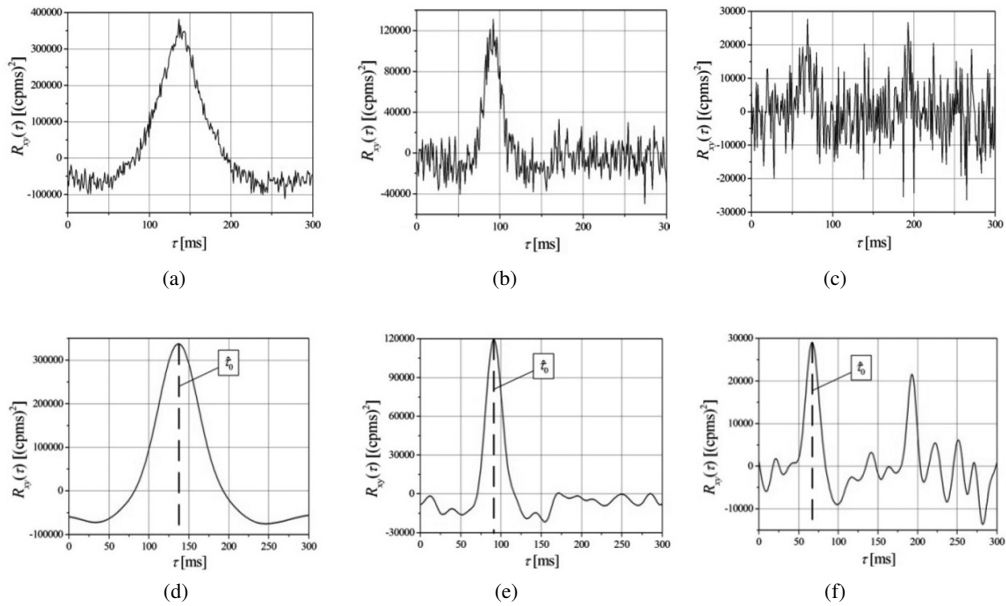

Fig. 6. Sample CCFs obtained directly for signals  $x(n)$  and  $y(n)$  for the plug flow (a), plug-bubble flow (b) and bubble (c) flow and after applying digital signal filtering (d)–(f) respectively [25].

where  $u_B(L)$  is the standard uncertainty of measurement of the distance  $L$ , and  $u_A(\hat{\tau}_0)$  is the standard uncertainty of time delay estimation [13, 25]. Indexes  $A$  and  $B$  denote the uncertainties of types  $A$  and  $B$ , respectively [26].

With the resultant normal distribution, the corresponding expanded uncertainty  $U(v_G)$  for the coverage factor  $k_p = 2.00$  (which corresponds to approximately 95% probability of expansion), is calculated according to the following formula:

$$U(v_G) = k_p u_c(v_G). \quad (6)$$

For the case presented in Figs. 6d–6f, the results  $v_G \pm U(v_G)$  are:  $v_G = (0.71 \pm 0.03)$  m/s for the plug flow,  $v_G = (1.06 \pm 0.05)$  m/s for the plug-bubble flow, and  $v_G = (1.45 \pm 0.07)$  m/s for the bubble flow, respectively. When the pipeline geometry is known, it is possible to calculate the dispersed phase flow rate.

#### 4. Void fraction determination

Void fraction is a very important parameter in liquid-gas flow measurements [27–33]. It gives information about the gas content in the flowing mixture. The amount of gas affects the velocity of individual phases and determines the flow regime. Void fraction  $\alpha$  is defined by the equation:

$$\alpha = \frac{V_G}{V}, \quad (7)$$

where:  $V_G$  is the volume of gas and  $V$  is the total mixture volume in the pipeline.

In the radioisotope method, a gamma-ray beam passes through the measuring cross-section of the pipe. For this selected cross-section, (7) can be replaced by the relationship:

$$\alpha = \frac{A_G}{A}, \quad (8)$$

where:  $A_G$  – the surface area occupied by air,  $A$  – surface area of the internal cross-section of the pipeline.

Figure 7 shows a cross-section of the pipeline and geometrical quantities used to evaluation of the void fraction.

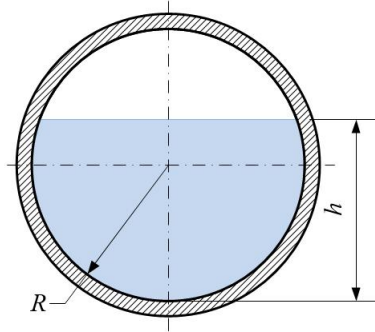

Fig. 7. Cross-section of the pipe:  $R$  – inner radius of the pipe,  $h$  – water level.

According to the geometrical parameters shown in Fig. 7, two cases can be considered [27]:

a)  $h < R$ :

$$\alpha = 1 - \frac{R^2 \arccos\left(1 - \frac{h}{R}\right) - (R - h)\sqrt{2Rh - h^2}}{\pi R^2}, \quad (9)$$

b)  $h > R$ :

$$\alpha = \frac{R^2 \arccos\left(\frac{h}{R} - 1\right) - (h - R)\sqrt{2Rh - h^2}}{\pi R^2}. \quad (10)$$

Calibration was performed under static conditions. The set of water levels in the pipe and gamma radiation intensity  $I$  recorded by one detector gave the points as shown in Fig. 8. The straight line was fitted to the measuring points using the LMS algorithm. The obtained calibration relation was as follows:

$$\ln(I) = 0.3977\alpha + 3.0562. \quad (11)$$

The standard uncertainties of the slope coefficient and the translation vector were 0.0116 cph (counts per channel) and 0.0082 cph respectively. The value of the coefficient of determination  $r^2$  was equal to 0.992. Equation (11) can be applied in order to evaluate the void fraction  $\alpha$  values on condition that the following parameters are known: background radiation, and radiation attenuated in a pipeline completely filled with water.

The slope of the fitted straight line depends only on the energy of gamma rays passing through the pipe and on the properties of the flowing mixture. It is, therefore, possible to use the previously defined function in different conditions (e.g. at different ambient temperatures). For the analysed plug, plug-bubble and bubble flows the following void fraction values  $\alpha \pm U(\alpha)$  were obtained:  $\alpha = (0.043 \pm 0.002)$ ,  $\alpha = (0.037 \pm 0.002)$ , and  $\alpha = (0.027 \pm 0.002)$  respectively.

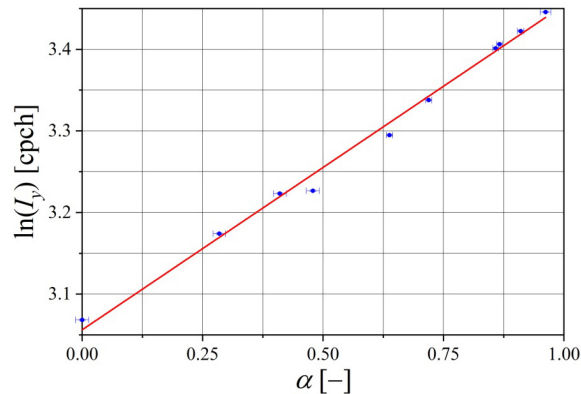

 Fig. 8. Graph of dependence  $\ln(I_y) = f(\alpha)$ .

## 5. Flow regime identification

Identification of the liquid-gas flow regime is important for the course of technological processes related to heat, momentum or mass transfer. For this purpose, we can use the same signals from the radiometric set that are applied to measure gas velocity or determine the void fraction. To identify two-phase flow structures, artificial intelligence methods, including various types of ANNs can be applied [29–35]. To effectively apply an ANN, we need to extract the features of the measurement signals that can be used as predictors. Statistical parameters of the signals from scintillation probes determined in the time and/or frequency domain can be used as these predictors (*e.g.* mean value, skewness, variance, kurtosis, selected power spectral density or cross-spectral density values, the surface area of these densities in a selected frequency range). Methods for extracting these parameters are described in [36] and [37]. Fig. 9a–9d shows selected predictors for the three liquid-gas flow regimes analysed: mean values, standard deviation values, kurtosis values, and *autocorrelation function* (ACF) values, determined for signals from Fig. 5 divided into 20,000 sample-long segments.

The predictors determined in this way (16 in total) were applied as input parameters of the Multi-Layer Perceptron-type ANN. The output parameters were the three analyzed flow structures. Various software environments can be used to build and analyse of artificial neural networks [34, 36, 39]. In this work, Statistica software was applied to construct, train and test the ANN. Various ANN configurations were analysed using Statistica Automated Neural Networks, and finally, the MLP 16-8-3 network was chosen [38]. The numbers given indicate the numbers of neurons in the input layer (16), hidden layer (8) and output layer (3). Description and test results of the above-mentioned network are presented in Table 1.

For the three flow types analysed: plug flow, transitional plug-bubble flow, and bubble flow 100% proper recognition results for testing and validation were obtained. To simplify the network structure, a reduction in the number of predictors can be applied. One of the methods is the PCA. It expounds the correlation structure of a given set of predictors by using a smaller set of linear combinations of them. The first principal component is the best summary of correlations between the predictors. This peculiar linear combination of the features accounts for more variability than any other conceivable linear combination. The second principal component is the second-best linear combination of the predictors, on the condition that it is orthogonal to the first principal component. The third component is the third-best linear combination of the features,

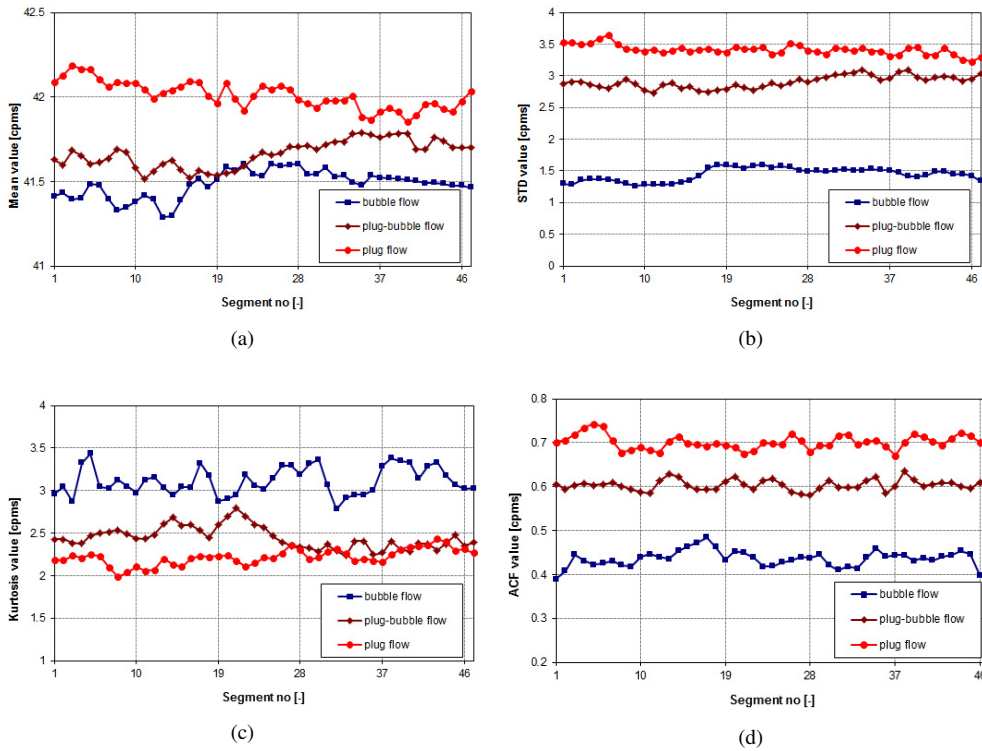

Fig. 9. Values of selected parameters of signals for three flow types analysed as a function of data segment number: (a) arithmetic mean, (b) standard deviation, (c) kurtosis, (d) ACF value.

Table 1. Specification and results of ANN 16-8-3 MLP.

	Parameter	Description
<b>Specification</b>	Learning algorithm	BFGS 16
	Activation function (hidden)	Tanh
	Activation function (output)	Linear
<b>Results</b>	Quality (training)	99.57%
	Quality (test)	100%
	Quality (validation)	100%

on the condition that it is orthogonal to the first two components, and so on [40]. To apply the PCA, first the predictors must be standardised, which is done using the Statistica software. The number of gained principal components was then limited based on the scree plot [38]. The principal components obtained in this way were used as new predictors for ANN. The final results and specification for the chosen MLP 4-4-3 ANN with the best properties are presented in Table 2.

All three types of flow analysed were recognised with 100% accuracy, and the MLP ANN structure using the PCA has been significantly simplified.

Table 2. Specification and results of ANN 4-4-3 MLP.

	Parameter	Description
<b>Specification</b>	Learning algorithm	BFGS 23
	Activation function (hidden)	Exponential
	Activation function (output)	Softmax
<b>Results</b>	Quality (training)	100%
	Quality (test)	100%
	Quality (validation)	100%

## 6. Conclusions

This paper presents the application of the gamma absorption method for evaluation of liquid-gas flow in a horizontal pipeline. The proposed analysis of measurement signals from scintillation detectors allow to determine the number of important flow parameters. The average gas phase velocity  $v_G$  can be determined using two signals and the cross-correlation method. The expanded relative uncertainty  $U(v_G)$  obtained for the three flow types studied in this paper (plug flow, transitional plug-bubble flow, and bubble flow) did not exceed 4.3% which is more than sufficient in numerous industrial applications. The signal from only one scintillation probe is sufficient for void fraction  $\alpha$  evaluation (after calibration). The maximum value of the expanded relative uncertainty values  $U(\alpha)$  obtained in this work was approx. 7.4%. In addition, it has been found that artificial intelligence methods, such as ANN, can be applied for recognition of the flow regime in dynamic conditions. In this case, one signal analysis is also sufficient. To use the artificial neural network, we need to determine the signal characteristics that will be used as predictors, and to train the network for the flows analysed. Application of a predictor reduction method (*e.g.* the PCA) makes it possible to simplify the network structure. All three types of flow analysed in this research studies were recognised with 100% accuracy using the MLP ANN.

The comprehensive analysis of liquid-gas flows presented in this article can be used, for example, in the mining industry to study the transport of the oil-natural gas mixture.

## Acknowledgments

The authors would like to thank dr Leszek Petryka for his cooperation during the measurements.

This work was supported by Rzeszów University of Technology under project UPB.EM. 20.001 and by the Polish Ministry of Science and Higher Education under the program “Regional Initiative of Excellence” in 2019–2022, project number 027/RID/2018/19, funding amount 11 999 900 PLN.

## References

- [1] Falcone, G., Hewitt, G. F., & Alimonti, C. (2009). *Multiphase flow metering: principles and applications*, Elsevier.
- [2] Powell, L. (2008). Experimental techniques for multiphase flows. *Physics of Fluids*, 20(4), 040605. <https://doi.org/10.1063/1.2911023>

- [3] Tan, C., Zhao, J., & Dong, F. (2015). Gas-water two-phase flow characterisation with electrical resistance tomography and multivariate multiscale entropy analysis. *ISA Transactions*, 55, 241–249. <https://doi.org/10.1016/j.isatra.2014.09.010>
- [4] Mohamad, E. J., Rahim, R. A., Rahiman, M. H. F., Ameran, H. L. M., Muji, S. Z. M., & Marwah, O. M. F. (2016). Measurement and analysis of water/oil multiphase flow using Electrical Capacitance Tomography sensor. *Flow Measurement and Instrumentation*, 47, 62–70. <https://doi.org/10.1016/j.flowmeasinst.2015.12.004>
- [5] Rahim, R. A., Yunos, Y. M., Rahiman, M. H. F., Muji, S. Z. M., Thiam, C. K., & Rahim, H. A. (2012). Optical tomography: Velocity profile measurement using orthogonal and rectilinear arrangements. *Flow Measurement and Instrumentation*, 23(1), 49–55. <https://doi.org/10.1016/j.flowmeasinst.2011.10.006>
- [6] Heindel, T. H., Gray, J. N., & Jensen, T. C. (2008). An X-ray system for visualizing fluid flows. *Flow Measurement Instrumentation*, 19(2), 67–78. <https://doi.org/10.1016/j.flowmeasinst.2007.09.003>
- [7] Lindken, R., & Merzkirch, W. (2002). A novel PIV technique for measurements in multiphase flows and its application to two-phase bubbly flows. *Experiments in Fluids*, 33, 814–825. <https://doi.org/10.1007/s00348-002-0500-1>
- [8] Lamadie, F., Charton, S., de Langlard, M., Ouattara, M., Sentis, M. P., Debayle, J., & Onofri, F. R. (2017). Development of optical techniques for multiphase flows characterization. *Fluids Engineering Division Summer Meeting*, USA. <https://doi.org/10.1115/FEDSM2017-69188>
- [9] Tamburini, A., Cipollina, A., Micale, G., & Brucato, A. (2013). Particle distribution in dilute solid liquid unbaffled tanks via a novel laser sheet and image analysis based technique. *Chemical Engineering Science*, 87, 341–358. <https://doi.org/10.1016/j.ces.2012.11.005>
- [10] Johansen, G. A., & Jackson, P. (2004). *Radioisotope gauges for industrial process measurements*. John Wiley. <https://doi.org/10.1002/0470021098>
- [11] Zych, M., Hanus, R., Vlasak, P., Jaszczur, M., & Petryka, L. (2017). Radiometric methods in the measurement of particle-laden flows. *Powder Technology*, 318, 491–500. <https://doi.org/10.1016/j.powtec.2017.06.019>
- [12] Zych, M., Hanus, R., Jaszczur, M., Mosorov, V., & Świsulski, D. (2018). Radioisotope measurement of selected parameters of liquid-gas flow using single detector system. *EPJ Web of Conferences*, 180, 02124. <https://doi.org/10.1051/epjconf/201818002124>
- [13] Hanus, R. (2015). Application of the Hilbert Transform to measurements of liquid-gas flow using gamma ray densitometry. *International Journal of Multiphase Flow*, 72, 210–217. <https://doi.org/10.1016/j.ijmultiphaseflow.2015.02.002>
- [14] Jaszczur, M. (2011). Numerical analysis of a fully developed non-isothermal particle-laden turbulent channel flow. *Archives of Mechanics*, 63(1), 77–91.
- [15] Pant, H. J., Goswami, S., Sharma, V. K., Mukherjee, T., Mukherjee, K., Guchhait, P. K., Rastogi, S., Pal, S., Thomas, S., Mukherjee, P., & Pujari, P. K. (2020). Investigation of flow dynamics of primary coolant in a delay tank of a swimming pool-type nuclear reactor using radiotracer technique. *Applied Radiation and Isotopes*, 156, 108982. <https://doi.org/10.1016/j.apradiso.2019.108982>
- [16] Kasban, H., Ali, E. H., & Arafa, H. (2017). Diagnosing plant pipeline system performance using radiotracer techniques. *Nuclear Engineering and Technology*, 49(1), 196–208. <https://doi.org/10.1016/j.net.2016.08.011>
- [17] Sugiharto, S., Stegowski, Z., Furman, L., Suud, Z., Kurniadi, R., Waris, A., & Abidin, Z. (2013). Dispersion determination in a turbulent pipe flow using radiotracer data and CFD analysis. *Computers & Fluids*, 79, 77–81. <https://doi.org/10.1016/j.compfluid.2013.03.009>

- [18] Salgado, C. M., Brandão, L. E., Schirru, R., Pereira, C. M., da Silva, A. X., & Ramos, R. (2009). Prediction of volume fractions in three-phase flows using nuclear technique and artificial neural network. *Applied Radiation and Isotopes*, 67(9), 1812–1818. <https://doi.org/10.1016/j.apradiso.2009.02.093>
- [19] Roshani, G. H., Nazemi, E., & Feghhi, S. A. H. (2016). Investigation of using  $^{60}\text{Co}$  source and one detector for determining the flow regime and void fraction in gas–liquid two phase flows. *Flow Measurement Instrumentation*, 50, 73–79. <https://doi.org/10.1016/j.flowmeasinst.2016.06.013>
- [20] Halstensen, M., Amundsen, L., & Arvoh, B. K. (2014). Three-way PLS regression and dual energy gamma densitometry for prediction of total volume fractions and enhanced flow regime identification in multiphase flow. *Flow Measurement Instrumentation*, 40, 133–141. <https://doi.org/10.1016/j.flowmeasinst.2014.09.006>
- [21] Hanus, R., Zych, M., Jaszczur, M., Szlachta, A., & Golijanek-Jędrzejczyk, A. (2019). Signal processing in the investigation of two-phase liquid-gas flow by gamma-ray absorption. *6th – 2019 International Conference on Control, Decision and Information Technologies (CoDIT'19)*, France. <https://doi.org/10.1109/CoDIT.2019.8820498>
- [22] Hanus, R., Zych, M., & Petryka, L. (2017). Investigation of liquid-gas flow in the pipeline by gamma-ray absorption. *Przeгляд Elektrotechniczny*, 93, 97–100 (in Polish). <http://doi.org/10.15199/48.2017.09.19>
- [23] Beck, M. S., & Płaskowski, A. (1987). *Cross-correlation flowmeters*. Adam Hilger.
- [24] Qiu, F., Liu, Z., Liu, R., Quan, X., Tao, C., & Wang, Y. (2019). Fluid flow signals processing based on fractional Fourier transform in a stirred tank reactor. *ISA Transactions*, 90, 268–277. <https://doi.org/10.1016/j.isatra.2019.01.004>
- [25] Zych, M., Hanus, R., Wilk, B., Petryka, L., & Świsulski, D. (2018). Comparison of noise reduction methods in radiometric correlation measurements of two-phase liquid-gas flows. *Measurement*, 129, 288–295. <https://doi.org/10.1016/j.measurement.2018.07.035>
- [26] Joint Committee for Guides in Metrology. (2008). *Guide to the Expression of Uncertainty in Measurement* (JCGM 100:2008). <https://www.bipm.org/en/publications/guides/gum.html>
- [27] Zych, M., Hanus, R., Jaszczur, M., Strzепowicz, A., Petryka, L., & Mastej, W. (2016). Determination of void fraction in two phase liquid-gas flow using gamma absorption. *Journal of Physics: Conference Series*, 745(3), 032124. <https://doi.org/10.1088/1742-6596/745/3/032124>
- [28] Roshani, G. H., Nazemi, E., Feghhi, S. A. H., & Setayeshi, S. (2015). Flow regime identification and void fraction prediction in two-phase flows based on gamma ray attenuation. *Measurement*, 62, 25–32. <https://doi.org/10.1016/j.measurement.2014.11.006>
- [29] Salgado, C. M., Pereira, C., Schirru, R., & Brandão, L. E. B. (2010). Flow regime identification and volume fraction prediction in multiphase flows by means of gamma-ray attenuation and artificial neural networks. *Progress in Nuclear Energy*, 52(5), 555–562. <https://doi.org/10.1016/j.pnucene.2010.02.001>
- [30] Roshani, G. H., Nazemi, E., & Roshani, M. M. (2017). Intelligent recognition of gas-oil-water three-phase flow regime and determination of volume fraction using Radial Basis Function. *Flow Measurement Instrumentation*, 54, 39–45. <https://doi.org/10.1016/j.flowmeasinst.2016.10.001>
- [31] Nazemi, E., Roshani, G. H., Feghhi, S. A. H., Setayeshi, S., Zadeh, E. E., & Fatehi, A. (2016). Optimization of a method for identifying the flow regime and measuring void fraction in a broad beam gamma-ray attenuation technique. *International Journal of Hydrogen Energy*, 41(18), 7438–7444. <https://doi.org/10.1016/j.ijhydene.2015.12.098>
- [32] Zhao, Y., Qin Cheng, B., & Richa, H. (2013). Recognition and measurement in the flow pattern and void fraction of gas-liquid two-phase flow in vertical upward pipes using the gamma densitometer. *Applied Thermal Engineering*, 60, 398–410. <https://doi.org/10.1016/j.applthermaleng.2013.07.006>

- [33] Roshani, G. H., Nazemi, E., Shama, F., Imani, M. A., & Mohammadi, S. (2018). Designing a simple radiometric system to predict void fraction percentage independent of flow pattern using radial basis function. *Metrology and Measurement Systems*, 25(2), 347–358. <http://doi.org/10.24425/119560>
- [34] Khorsandi, M., Fegghi, S. A. H., Salehizadeh, A., & Roshani, G. H. (2013). Developing a gamma ray fluid densitometer in petroleum products monitoring applications using Artificial Neural Network. *Radiation measurements*, 59, 183–187. <https://doi.org/10.1016/j.radmeas.2013.06.007>
- [35] Shanthi, C., & Pappa, N. (2017). An artificial intelligence based improved classification of two-phase flow patterns with feature extracted from acquired images. *ISA Transactions*, 68, 425–432. <https://doi.org/10.1016/j.isatra.2016.10.021>
- [36] Hanus, R., Zych, M., Kusy, M., Jaszczur, M., & Petryka, L. (2018). Identification of liquid-gas flow regime in a pipeline using gamma-ray absorption technique and computational intelligence methods. *Flow Measurement Instrumentation*, 60, 17–23. <https://doi.org/10.1016/j.flowmeasinst.2018.02.008>
- [37] Hanus, R., Zych, M., Petryka, L., Jaszczur, M., & Hanus, P. (2016). Signals features extraction in liquid-gas flow measurements using gamma densitometry. Part 1: time domain. *EPJ Web of Conferences*, 114, 02035. <https://doi.org/10.1051/epjconf/201611402036>
- [38] Hanus, R., Zych, M., Petryka, L., Świsulski, D., & Strzëpowicz, A. (2017). Application of ANN and PCA to two-phase flow evaluation using radioisotopes. *EPJ Web of Conferences*, 143, 02033. <https://doi.org/10.1051/epjconf/201714302033>
- [39] Larose, D. T. (2005). *Discovering knowledge in data: an introduction to data mining*. John Wiley & Sons. <https://doi.org/10.1002/0471687545>
- [40] Larose, D. T. (2006). *Data mining methods and models*. John Wiley & Sons. <https://doi.org/10.1002/0471756482>



Robert Hanus received his Ph.D. at Lviv Polytechnical National University (Ukraine) and the D.Sc. at Rzeszów University of Technology (Poland) in 1997 and 2016, respectively. He is currently employed as associate professor and head of the Department of Metrology and Diagnostic Systems at the Faculty of Electrical and Computer Engineering at Rzeszów University of Technology. His scientific interests include metrology, measurement systems and signal processing. He is author or co-author of over 200 papers.



Marcin Zych is employed at the Faculty of Geology, Geophysics and Environmental Protection of the AGH University of Science and Technology, currently as university professor. Main research interests: application of radiometric techniques in analysis of multiphase flows and well-logging, statistical methods of signal and data analysis. His hobby is history of technology, art and astronomy.



Volodymyr Mosorov received the M.Sc. and the Ph.D. degrees in telecommunication from the Lviv Polytechnical National University, Ukraine in 1983 and 1998, respectively. In 2009 he received the D.Sc. degree (habilitation) in Computer Science from the AGH University of Science and Technology in Cracow, Poland. He has worked at the Institute of Applied Computer Science (previously the Computer Engineering Department), at the Faculty of Electrical, Electronic, Computer and Control Engineering, TUL since 2000, currently as Professor of Lodz University of Technology. His scientific activity includes advanced image and signal processing techniques, nondestructive testing applied in industrial processes, and design of medical devices.



Anna Golijanek-Jędrzejczyk received her Ph.D. in Metrology in 2007. She works as an assistant professor at the Faculty of Electrical and Control Engineering at Gdańsk University of Technology. Her scientific interests include the following: metrology, measurement systems and uncertainty analysis. Her publications may be found at [www.researchgate.net](http://www.researchgate.net) and <http://scholar.google.pl>.



**Marek Jaszczur** is an associate professor at the AGH University of Science and Technology, Faculty of Energy and Fuels, Kraków, Poland. He teaches advanced heat transfer, computer science and CFD. His research is an interdisciplinary blend of applied mathematics, heat transfer, fluid mechanics and numerical methods. He uses direct numerical simulations, large-eddy simulations, particle image velocity, laser-induced fluorescence as tools to explore the world. He is member of the ERCOFTAC, Committee on Thermodynamic and Combustion section of Thermodynamics, an Erasmus coordinator and author or co-author of over 215 papers.

He is member of the ERCOFTAC, Committee on Thermodynamic and Combustion section of Thermodynamics, an Erasmus coordinator and author or co-author of over 215 papers.



**Artur Andruszkiewicz** has been employed at the Faculty of Mechanics and Energy of Wrocław University of Science and Technology since 1986, currently as a professor of the University. He obtained his Ph.D. in 1996 and habilitation in 2010. His area of scientific interest includes: metrology of non-electrical quantities, thermal metrology and testing of energy machines and devices. He is the author of over 100 scientific publications in that field. He has been a multiple DAAD scholarship holder at TU-Dresden.