

Online parameter identification of SPMSM based on improved artificial bee colony algorithm

CHUNLI WU , SHUAI JIANG, CHUNYUAN BIAN

*College of Information Science and Engineering, Northeastern University
China*

e-mail: {wuchunli/bianchunyuan}@ise.neu.edu.cn, jiangshuai@stumail.neu.edu.cn

(Received: 19.01.2021, revised: 24.04.2021)

Abstract: The artificial bee colony (ABC) intelligence algorithm is widely applied to solve multi-variable function optimization problems. In order to accurately identify the parameters of the surface-mounted permanent magnet synchronous motor (SPMSM), this paper proposes an improved ABC optimization method based on vector control to solve the multi-parameter identification problem of the PMSM. Because of the shortcomings of the existing parameter identification algorithms, such as high computational complexity and data saturation, the ABC algorithm is applied for the multi-parameter identification of the PMSM for the first time. In order to further improve the search speed of the ABC algorithm and avoid falling into the local optimum, Euclidean distance is introduced into the ABC algorithm to search more efficiently in the feasible region. Applying the improved algorithm to multi-parameter identification of the PMSM, this method only needs to sample the stator current and voltage signals of the motor. Combined with the fitness function, the online identification of the PMSM can be achieved. The simulation and experimental results show that the ABC algorithm can quickly identify the motor stator resistance, inductance and flux linkage. In addition, the ABC algorithm improved by Euclidean distance has faster convergence speed and smaller steady-state error for the identification results of stator resistance, inductance and flux linkage.

Key words: artificial bee colony algorithm, Euclidean distance, online identification, parameter identification, surface-mounted permanent magnet synchronous motor

1. Introduction

Permanent magnet synchronous motors (PMSMs) have the advantages of small size, simple structure, high power density, stable performance, etc., and they are widely applied in high-performance industrial fields. In actual motor operation control systems, the motor parameters



© 2021. The Author(s). This is an open-access article distributed under the terms of the Creative Commons Attribution-NonCommercial-NoDerivatives License (CC BY-NC-ND 4.0, <https://creativecommons.org/licenses/by-nc-nd/4.0/>), which permits use, distribution, and reproduction in any medium, provided that the Article is properly cited, the use is non-commercial, and no modifications or adaptations are made.

are constantly changing with the change of the motor's service time, temperature and other operating conditions, which will lead to the decline of the motor control performance, hence affect the motor's operating state. Therefore, the identification of motor parameters is conducive to the stable operation of the motor. In motor vector control, the current loop PI controller's parameter tuning is usually based on the stator resistance, the dq -axis inductance and the rotor flux linkage. The accurate identification and acquisition of these parameters has been widely concerned by scholars globally.

Online parameter identification is one of the research hotspots in the field of motor control. The main research methods include the recursive least square algorithm [1–3], model reference adaptive system [4], extended Kalman filter algorithm [5], neural network algorithm [6–8], particle swarm optimization [9–16] and artificial bee colony (ABC) algorithm [17, 18], etc. Ref. [1–3] adopted the recursive least squares method. This method is widely applied because of its simple calculation feature. However, due to a large amount of calculation data, the data is easy to saturate, and real-time parameter updates are prone to problems. Ref. [4] used a model reference adaptive algorithm and applied fuzzy control to it, but the accuracy of the identification parameters with this method depends on the adjustment of the PI parameters, and improper selection of parameters will cause large identification errors. Ref. [5] suggested the extended Kalman filter algorithm to try to reduce the influence of noise interference and achieve better parameter identification results. However, because more matrix operations are involved in the calculation process, the calculation complexity is high, which will cause the accumulation of errors and cause the algorithm to diverge. Ref. [6–8] brought up a neural network algorithm to identify the parameters of the motor. This method reduces the steady-state error of motor parameters and improves the convergence speed of identification parameters. However, the stability of the identification effect and the speed of convergence are highly dependent on the convergence factor, and the degree of convergence of the algorithm is very sensitive to data training. Ref. [9–16] all used particle swarm optimization, and Ref. [11] proposed a global parameter identification method of the PMSM, but the convergence of the algorithm has not been proved theoretically, which limits the practical application of the algorithm. Ref. [17, 18] respectively carried out theoretical analysis and algorithm application of the ABC algorithm, but they failed to apply it in the motor field to solve the parameter identification problem of the PMSM.

In order to solve the above problems, this paper proposes to apply an improved ABC algorithm to the multi-parameter identification problem of the PMSM. First of all, this paper constructs the full-rank equation of the PMSM motor model through the instantaneous injection of the $i_d \neq 0$ negative current in the d -axis of the PMSM stator and $i_d = 0$ vector control for parameter identification. Then, by analyzing the operating mechanism of the ABC algorithm and combining it with PMSM parameter identification, an improved ABC algorithm is proposed based on Euclidean distance. Finally, the improved algorithm is used to identify the stator resistance, inductance and flux linkage of the PMSM and the experiment verifies that the improved algorithm has faster convergence speed and smaller steady-state error.

2. Mathematical model of PMSM

For the surface-mounted permanent magnet synchronous motor (SPMSM) [19], when eddy current loss, iron loss and magnetic saturation are ignored, the voltage equations in the dq

synchronous rotating coordinate system are:

$$\begin{cases} u_d = R_s i_d - \omega_e L_q i_q + L_d \frac{di_d}{dt} \\ u_q = R_s i_q + \omega_e L_d i_d + \omega_e \psi_f + L_q \frac{di_q}{dt} \end{cases}, \quad (1)$$

where: i_d and i_q represent the stator current of the dq -axis, respectively; u_d and u_q represent the stator voltage of the dq -axis, respectively; L_d and L_q represent the inductance of the dq -axis, respectively; ω_e is the angular speed of the motor; R_s is the stator resistance; and ψ_f is the rotor flux linkage.

The vector control adopts $i_d = 0$ control strategy, and since the differential term of the dq -axis current is approximately equal to 0 when the motor is running stably, Eq. (1) can be simplified to:

$$\begin{cases} u_d = -\omega_e L_q i_q \\ u_q = R_s i_q + \omega_e \psi_f \end{cases}. \quad (2)$$

Since the research object is a surface-mount PMSM, the d -axis inductance L_d is approximately equal to the q -axis inductance L_q , that is, $L_d = L_q = L_s$, where L_s is the motor inductance. Thus, Eq. (2) can be simplified to:

$$\begin{cases} u_d = -\omega_e L_s i_q \\ u_q = R_s i_q + \omega_e \psi_f \end{cases}. \quad (3)$$

It can be seen from Eq. (3) that the motor inductance L_s can be identified by the steady-state d -axis voltage, q -axis current and motor speed. However, for the identification of the stator resistance R_s and rotor flux linkage ψ_f , the equations have under-rank problems, and the equations will get countless solutions. To solve the coupling problem between parameters, a $i_d \neq 0$ negative current strategy of instantaneous injection to the d -axis can be used [7]. Figure 1 is the d -axis instantaneous negative sequence current injection waveform.

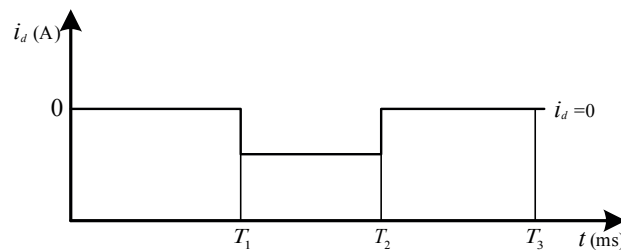

Fig. 1. The d -axis instantaneous negative sequence current injection waveform

When in section $T_1 - T_2$, the d -axis voltage equation is:

$$u_d(t_2) = R_s i_d(t_2) - \omega_e(t_2) L_s(t_2) i_q(t_2), \quad (4)$$

where $t_2 \in (T_1, T_2)$.

When in section $T_2 - T_3$, the d -axis voltage equation is:

$$u_d(t_3) = -\omega_e(t_3)L_s(t_3)i_q(t_3), \quad (5)$$

where $t_3 \in (T_2, T_3)$.

Since the change of the q -axis current mainly depends on the load torque, and the action time of the d -axis current is short, the response speed of the current loop is much greater than that of the speed loop, hence $i_q(t_2) = i_q(t_3)$, $\omega_e(t_2) = \omega_e(t_3)$. It is assumed that the injection of the d -axis current will not change the inductance value. Equation (5) minus Eq. (4) gives:

$$u_d(t_3) - u_d(t_2) = R_s i_d(t_2). \quad (6)$$

From Eq. (6), it can be seen that the stator resistance can be identified according to the difference between the change of the d -axis current and voltage. The rotor flux linkage ψ_f can be identified by the q -axis voltage in Eq. (2). Therefore, the full-rank equation of the PMSM motor model is constructed under the two states of instantaneous injection of the $i_d \neq 0$ negative current and $i_d = 0$ vector control to the d -axis of the PMSM stator for parameter identification.

3. Parameter identification of PMSM based on ABC algorithm

3.1. Artificial bee colony algorithm

The ABC algorithm is a global optimization algorithm based on group intelligence proposed by Karaboga in 2005. The algorithm does not need to consider the specific information of the problem, and it only needs to compare the pros and cons of the problem and find the optimal solution to the global problem through the individual behavior of each artificial bee.

The ABC algorithm is to simulate the actual bee collecting honey to solve the problem. Artificial bees are divided into three categories: employed bees, onlooker bees and scout bees.

The algorithm can be divided into the following phases:

1. Initialization phase

Suppose the number of honey sources is SN , the solution space of the problem is d -dimensional, and the i -th honey source is the i -th corresponding solution $X_i = \{x_{i1}, x_{i2}, \dots, x_{iD}\}$. The fitness value of X_i is fit_i , where $i = 1, 2, \dots, SN$ and $d = 1, 2, \dots, D$.

x_d^{\max} and x_d^{\min} are the maximum and minimum values of the d -th dimension. Employed bees search for possible solutions according to the following Eq. (7):

$$x_{id} = x_d^{\min} + r(x_d^{\max} - x_d^{\min}), \quad (7)$$

where r is a random number on the interval $[0, 1]$.

2. Employed bee phase

The employed bees seek new food sources from the i -th food source according to Eq. (8):

$$x'_{id} = x_{id} + \phi_{id}(x_{id} - x_{kd}), \quad (8)$$

where ϕ_{id} is a random number on the interval $[-1, 1]$ and $k \neq i$. The ABC algorithm generates a new solution $X'_i = \{x'_{i1}, x'_{i2}, \dots, x'_{iD}\}$, and utilizes a greedy selection strategy to compare with the original solution $X_i = \{x_{i1}, x_{i2}, \dots, x_{iD}\}$, eventually keeping the better solution.

3. Onlooker bee phase

The employed bees share food source information with onlooker bees, and randomly switch from employed bees to onlooker bees according to probability Eq. (9):

$$p_i = \frac{fit_i}{\sum_{j=1}^{S_j} fit_j} \quad (9)$$

The fitness value fit_i is calculated by Eq. (10):

$$fit_i = \begin{cases} \frac{1}{1 + f(x_i)}, & f(x) \geq 0 \\ 1 + |f(x_i)|, & f(x) < 0 \end{cases}, \quad (10)$$

where $f(x)$ is the function value of the solution.

Then according to Eq. (8), search in the neighbourhood of the selected solution, calculate the fitness value, and use the greedy selection strategy to retain the better solution.

4. Scout bee phase

If the fitness value of a food source is not found within the set limit times, then the food source will be discarded. Correspondingly, the employed bee is transformed into the scout bee, and the scout bee searches for a new source of nectar according to Eq. (7). Figure 2 is a flowchart of the ABC algorithm.

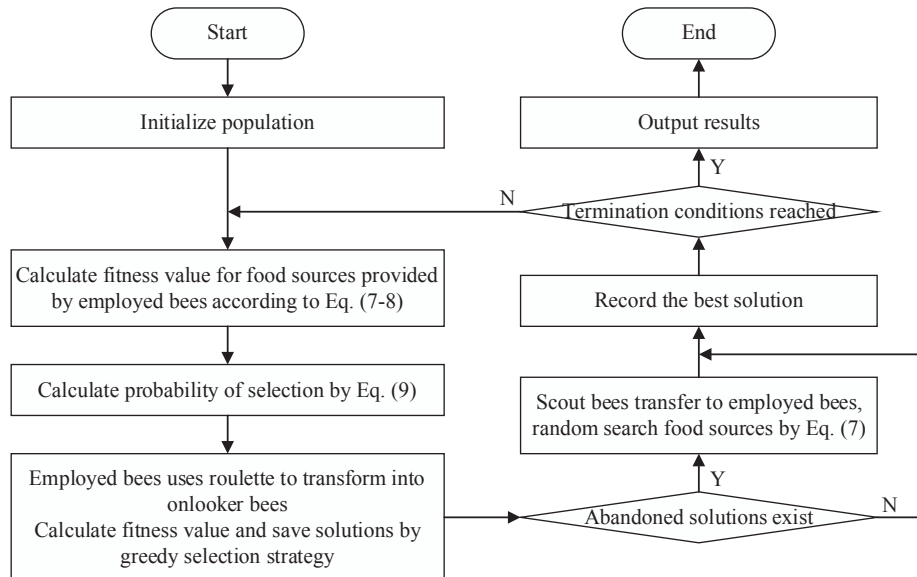

Fig. 2. Flow chart of ABC algorithm

3.2. Improved artificial bee colony algorithm

When the onlooker bees are looking for a new food source according to Eq. (8), they will find it from SN foods again. To make finding a food source more efficient, x_{id} in Eq. (8) can be redefined as x_{id}^{best} by Eq. (11).

$$x_{id}^{\text{best}'} = x_{id}^{\text{best}} + \phi_{id} (x_{id}^{\text{best}} - x_{kd}). \quad (11)$$

At the end of the employed bee phase of the ABC algorithm, the Euclidean distance $d(i, j)$ can be calculated according to Eq. (12):

$$d(i, j) = \sqrt{\sum_{d=1}^D (x_{id} - x_{jd})^2}. \quad (12)$$

Then calculate the average Euclidean distance md_m by Eq. (13):

$$md_m = \frac{\sum_{j=1}^{SN} d(i, j)}{SN - 1}. \quad (13)$$

When $d(i, j) \leq r^* md_m$ assume the food sources are X_i , where $X_j = \{x_{j1}, x_{j2}, \dots, x_{jD}\}$, and r is the radius of the neighbourhood, and $r \geq 0$. When $r = 0$, because of $x_{id}^{\text{best}} = x_{id}$, Eq. (11) is equal to Eq. (8), and the improved ABC algorithm will be transformed into the ABC algorithm. Then calculate the fitness value of X_j , assuming that the number of X_j is m , select the food source with the largest fitness value as the best food source x_{id}^{best} according to Eq. (14):

$$\text{fit}(x_{id}^{\text{best}}) = \max(\text{fit}(x_{id}^1), \text{fit}(x_{id}^2), \dots, \text{fit}(x_{id}^m)). \quad (14)$$

3.3. Parameter identification based on improved artificial bee colony algorithm

In the improved ABC algorithm, the parameter identification problem of the PMSM is actually an optimization problem in the iterative calculation process. The adjustable model is continuously adjusted through the fitness function until the system parameters are identified. The fitness function is shown in Eq. (15).

$$f(x) = (i_{d1} - \hat{i}_{d1})^2 + (i_{q1} - \hat{i}_{q1})^2 + (i_{d2} - \hat{i}_{d2})^2, \quad (15)$$

where: i_{d1} and i_{q1} are measured by the motor in the control mode of $i_d = 0$, \hat{i}_{d1} and \hat{i}_{q1} are calculated by the motor in the control mode of $i_d = 0$, i_{d2} is the given d -axis current value of the motor in the control mode of $i_d \neq 0$, \hat{i}_{d2} is the calculated value of the motor in the control mode of $i_d \neq 0$. Figure 3 shows the schematic diagram of PMSM parameter identification based on the improved ABC algorithm.

The following are the steps of PMSM parameter identification based on the improved ABC algorithm.

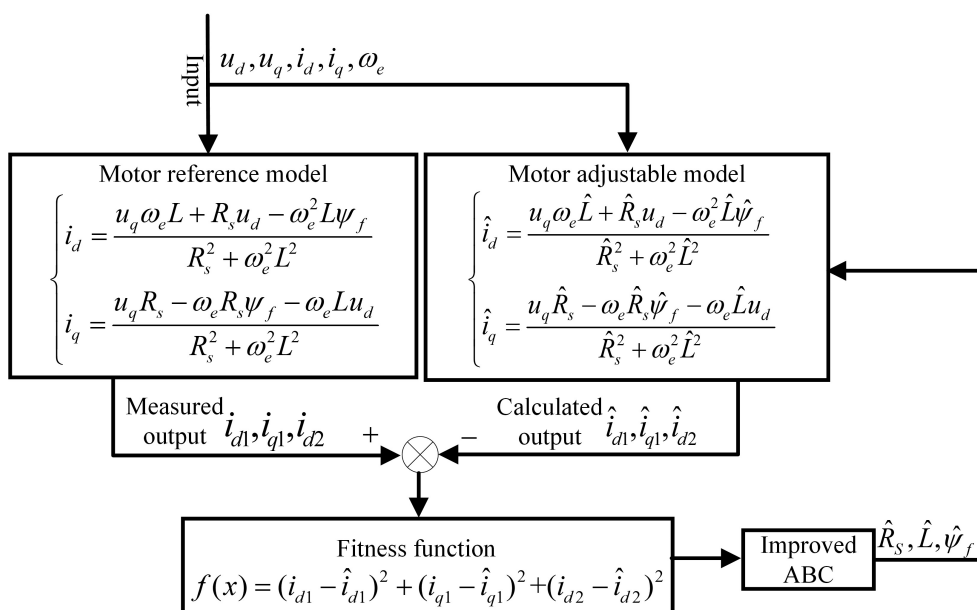

Fig. 3. Schematic diagram of PMSM parameter identification with improved ABC algorithm

Step 1. Initialize the number of food sources N , the dimension of the solution space is set to 3, the number of iteration times for any food source is limited to lim , and set the range of the parameters to be identified, including R_s, L_s , and ψ_f ;

Step 2. Generate an $N * 3$ solution space according to Eq. (7);

Step 3. In the newly generated $N * 3$ space, each group of food sources generates a new group of food sources according to Eq. (8);

Step 4. Collect and save the actual values of dq -axis current and voltage in $i_d = 0$ and $i_d \neq 0$ modes, and calculate dq -axis current and voltage by the full-rank equation constructed by Eq. (3) and Eq. (6) where each new food source generated by Eq. (8) and its corresponding old food source are substituted;

Step 5. Substitute the actual value and the calculated value into the fitness function, i.e., Eq. (15), and then substitute the result into Eq. (10) to obtain the fitness value and record it, compare the size of the two fitness values in each group, and keep the larger fitness value corresponding food information;

Step 6. Calculate and record the Euclidean distance between one group of food sources and other food sources according to Eq. (12);

Step 7. Calculate the average Euclidean distance according to Eq. (13), retain the food sources which have less distance than the average Euclidean distance, calculate its fitness value, and retain the food source corresponding to the largest fitness value. Cycle N times of this step, and a new $N * 3$ food space can be obtained;

Step 8. According to probability Eq. (9), in the new $N * 3$ food source space, the employed bee is transformed to the onlooker bee;

Step 9. Onlooker bees generate a new food source space by Eq. (8), and then repeat steps 3 and 4 to update the food source information;

Step 10. If the fitness value of a food source is not found within the *lim* times of the set value, the food source will be discarded and return to step 2. Otherwise, a group of best food sources will be output by comparing the fitness value in the entire food source space.

Figure 4 is a structural diagram of an online parameter identification system for the PMSM based on an improved ABC algorithm with vector control. It can be seen from Fig. 4 that u_d , u_q , i_d , i_q and ω_e collected in the vector control system of the PMSM are the input of the improved ABC algorithm. After the iterative calculation of steps 1–10 mentioned above, the R_s , L_s , and ω_e output by the algorithm are returned to the dq -axis current PI regulator of the PMSM vector control system, which constitutes the PMSM motor online identification system.

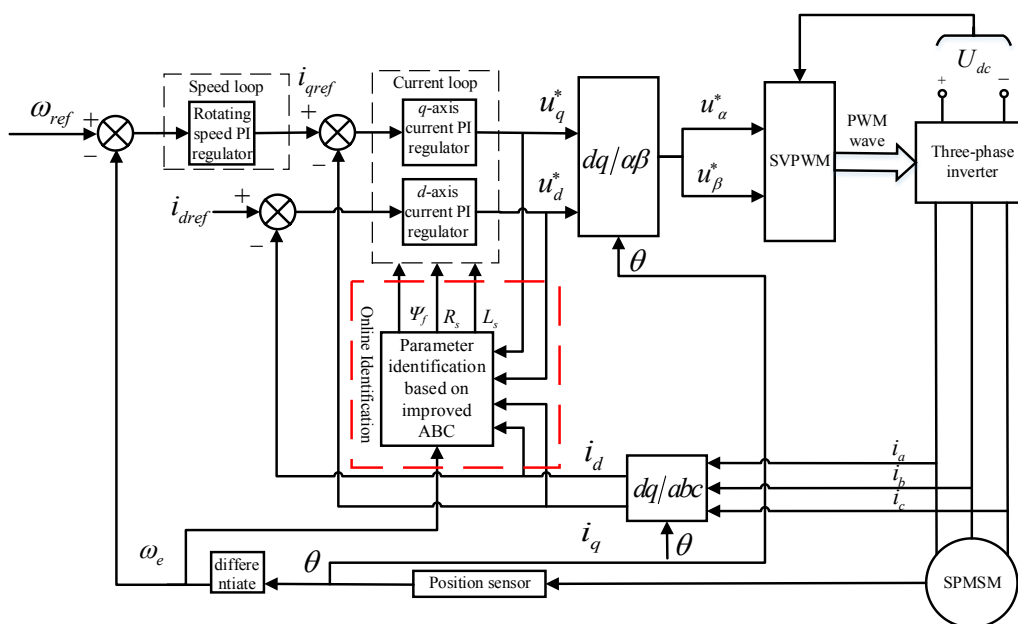

Fig. 4. Structure diagram of online parameter identification system of PMSM based on improved ABC algorithm with vector control

4. Simulink simulation analysis

To verify the correctness and effectiveness of the proposed PMSM parameter identification based on the improved ABC algorithm, this paper establishes a simulation model of the system based on the vector control system in the MATLAB/Simulink environment, as shown in Fig. 4. The rated parameters of the motor are shown in Table 1.

Figure 5 shows the simulation waveforms of the fitness value, stator resistance, inductance, and flux linkage of the PMSM parameter identification based on the ABC algorithm and the improved ABC algorithm. The two algorithms are simulated and compared in the MATLAB/Simulink

Table 1. The rated parameters of PMSM

Parameter	Value
Rated power / kW	1
Rated rotating speed / (r/min)	2500
Rated torque / (N·m)	4
Peak torque / (N·m)	12
Rated current / A	4
Rated voltage / V	220
Stator resistance R / Ω	2.59
Line inductance L / mH	8.5
Flux linkage ψ_f / Wb	0.0733
Number of pole pairs	4

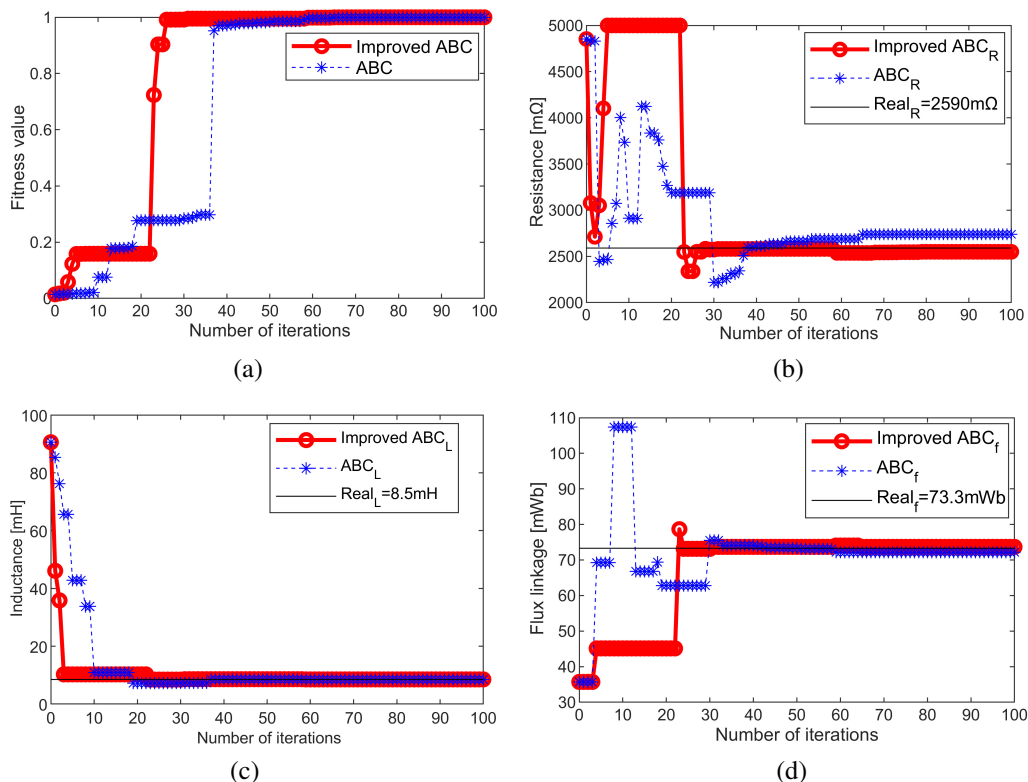

Fig. 5. PMSM parameter identification convergence curves: fitness value (a); resistance (b); inductance (c); flux linkage (d)

environment to verify the superiority of the improved ABC algorithm in motor parameter identification. The motor speed runs at the rated speed of 2500 r/min, the negative current setting is -2 A, the injection time is 500 ms, and the load torque is 4 N·m. In order to ensure the accuracy of simulation comparison, the maximum number of iterations of the two algorithms is set to 100, the numbers of food sources are 10, and the simulation periods are 1 s. The initial domains of resistance, inductance and flux linkage are $[0, 5 \Omega]$, $[0, 100 \text{ mH}]$ and $[0, 1000 \text{ mWb}]$, respectively. The waveform curves of each parameter of the two algorithms for 100 iterations are shown in Fig. 5, and the simulation results are listed in Table 2.

Table 2. The comparison of simulation results

Parameter	Desired point	The ABC algorithm		The improved ABC algorithm	
		Identification	Error (%)	Identification	Error (%)
R / Ω	2.59	2.749	6.14	2.550	1.54
L / mH	8.5	8.477	0.27	8.510	0.12
ψ_f / Wb	0.0733	0.07184	1.99	0.07358	0.38

From the convergence curves in Fig. 5(a), it can be seen that the ABC algorithm entered the local search at the 38-th iteration, while the improved ABC algorithm entered the local search at the 25-th iteration. The improved ABC algorithm has faster iteration speed.

It can be seen from Fig. 6 that the improved ABC algorithm has a better convergence speed than the ABC algorithm. Compared with the ABC algorithm, the improved ABC algorithm reduces the number of stator resistance iterations by 12 times and the number of inductance iterations by 8 times. Meanwhile, the number of flux linkage iterations is reduced by 7 times.

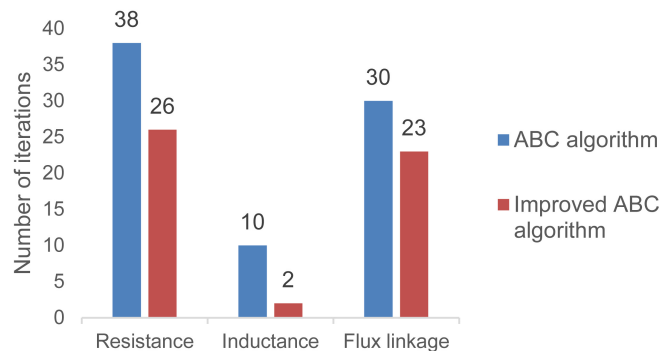

Fig. 6. Comparison of the convergence for key PMSM parameters

It can also be seen from Table 2 that the improved ABC algorithm has higher identification accuracy, and the results are closer to the real values. Compared with the ABC algorithm, the improved ABC algorithm reduces the stator resistance error by 4.60% and the inductance error by 0.15%, while the flux linkage error is reduced by 1.61%. These results show that the improved

ABC algorithm based on Euclidean distance is more effective in searching for solutions, thereby increasing the convergence speed of the identification results and reducing the steady-state error.

5. Experimental verification

In order to verify the performance of the parameter identification algorithm under dynamic operating conditions, the experiments have been performed by using a 1 kW SPMSM and a motor main control system with TMS320F28069M. The experimental platform is shown in Fig. 7. The parameters of the PMSM are shown in Table 1.

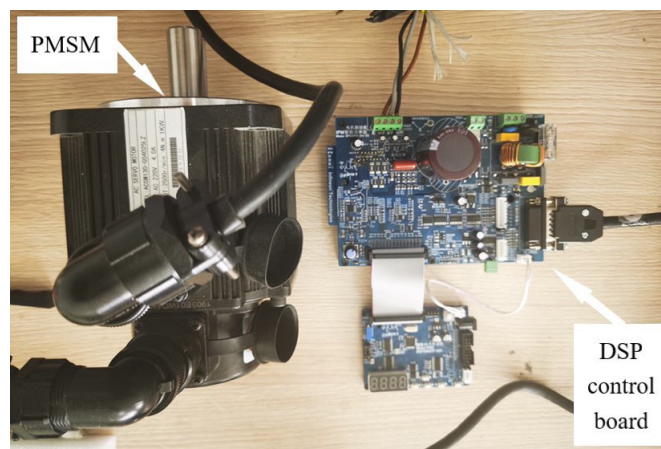

Fig. 7. The experiment platform

The parameter identification of the PMSM based on the ABC algorithm and the improved ABC algorithm is respectively verified by experiments. The motor speed is 2500 r/min, the negative current is given as -2 A, the injection time is 500 ms, and the load torque is 4 N·m. The motor parameters identified during the experiment are recorded by the upper computer, and the waveform of the identification result is output in MATLAB, as shown in Fig. 8.

It can be seen in Fig. 8 that the improved ABC algorithm performs better than the ABC algorithm in the identification of the resistance value, inductance value and flux linkage value of the PMSM under dynamic operating conditions. Figures 8(a)–8(c) are the results of the parameter identification of PMSM stator resistance, inductance and flux linkage. The convergence time of the ABC algorithm for these three parameters is approximately 0.623 s, 0.292 s and 0.613 s, respectively. Moreover, the convergence time of the improved ABC algorithm for the identification of these three parameters is about 0.602 s, 0.230 s and 0.602 s, respectively. It can be seen that introducing Euclidean distance to the ABC algorithm can effectively improve the convergence speed of the identification. Furthermore, from Figs. 8(a)–8(c), it can be clearly seen that compared with ABC algorithm, the improved ABC algorithm has better results in steady-state error and waveform pulsation amplitude of the stator resistance, inductance and flux linkage.

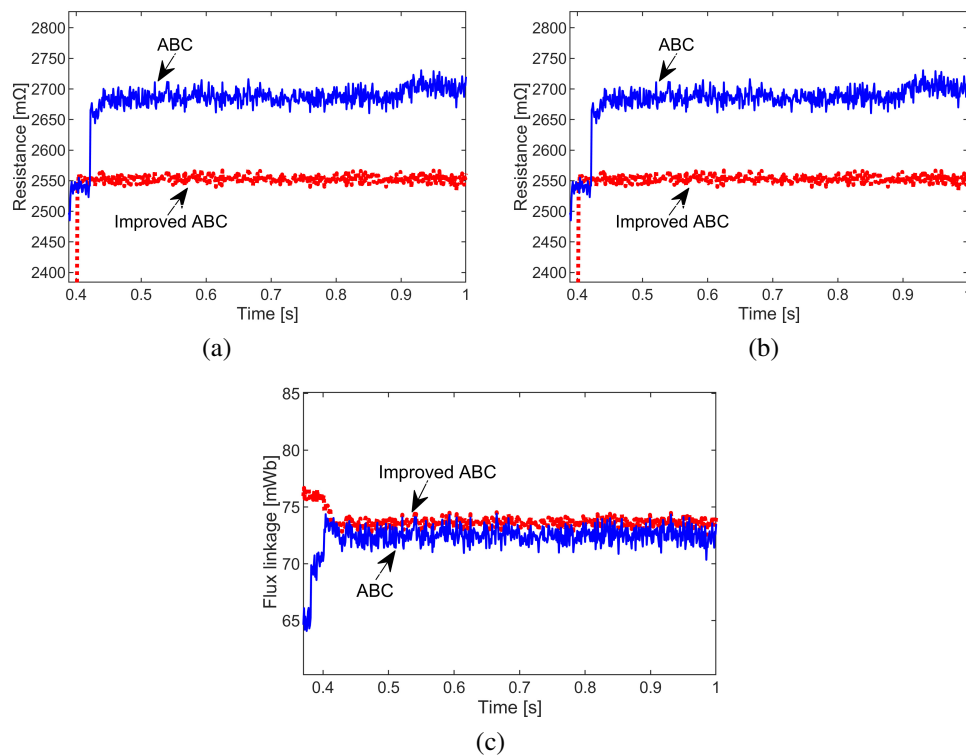

Fig. 8. PMSM parameters identification curves under dynamic operating conditions: resistance (a); inductance (b); flux linkage (c)

6. Conclusions

This paper presents an instantaneous reverse sequence injection method to solve the parameter coupling problem in the parameter identification of the PMSM under $i_d = 0$ conditioned vector control, and the full rank equation of the motor model is established. In view of the shortcomings of the existing parameter identification algorithms, the ABC algorithm is applied to the multi-parameter identification of PMSMs. Through the analysis of the conventional ABC algorithm mechanism, an improved ABC algorithm based on Euclidean distance is proposed for the online identification of the stator resistance, inductance value and flux linkage parameters of PMSMs, and the two algorithms have been simulated and experimented. The research results show that compared with the conventional ABC algorithm, the improved ABC algorithm has faster convergence speed and smaller steady-state error in parameter identification. In addition, the algorithm has wide adaptability and strong robustness, and can also be applied to other multi-variable optimizations.

Acknowledgements

This work was supported by the National Natural Science Foundation of China under Grant 61773006.

References

- [1] Boileau T., Leboeuf N., Nahid-Mobarakeh B., *Online identification of PMSM parameters: parameter identifiability and estimator comparative study*, IEEE Transactions on Industry Applications, vol. 47, no. 4, pp. 1944–1957 (2011), DOI: [10.1109/TIA.2011.2155010](https://doi.org/10.1109/TIA.2011.2155010).
- [2] Ichikawa S., Tomita M., Doki S., *Sensorless control of permanent-magnet synchronous motors using online parameter identification based on system identification theory*, IEEE Transactions on Industrial Electronics, vol. 53, no. 2, pp. 363–372 (2006), DOI: [10.1109/TIE.2006.870875](https://doi.org/10.1109/TIE.2006.870875).
- [3] Jian-fei S., Bao-jun G., Yan-ling L., *Research of parameter identification of permanent magnet synchronous motor online*, Electric Machines and Control, vol. 22, no. 3, pp. 17–24 (2018), DOI: [10.15938/j.emc.2018.03.003](https://doi.org/10.15938/j.emc.2018.03.003).
- [4] Fan S., Luo W., Zou J., *A hybrid speed sensorless control strategy for PMSM based on MRAS and fuzzy control*, Proceedings of 7th International Power Electronics and Motion Control Conference, Harbin, China, pp. 2976–2980 (2012), DOI: [10.1109/IPEMC.2012.6259344](https://doi.org/10.1109/IPEMC.2012.6259344).
- [5] Shi Y., Sun K., Huang L., *Online identification of permanent magnet flux based on extended Kalman filter for IPMSM drive with position sensorless control*, IEEE Transactions on Industrial Electronics, vol. 59, no. 11, pp. 4169–4178 (2012), DOI: [10.1109/TIE.2011.2168792](https://doi.org/10.1109/TIE.2011.2168792).
- [6] Liu K., Zhang J., *Adaline neural network based online parameter estimation for surface-mounted permanent magnet synchronous machines*, Proceedings of the CSEE, vol. 30, no. 30, pp. 68–73 (2010).
- [7] Gu X., Hu S., Shi T., *Muti-parameter decoupling online identification of permanent magnet synchronous motor based on neural network*, Transactions of China Electrotechnical Society, vol. 30, no. 6, pp. 114–121 (2015).
- [8] Liwei Z., Peng Z., Yuefeng L., *Parameter identification of permanent magnet synchronous motor based on variable step-size Adaline neural network*, Transactions of China Electrotechnical Society, vol. 33, no. z2, pp. 377–384 (2018).
- [9] Pe erez J.N.H., Hernandez O.S., Caporal R.M., *Parameter identification of a permanent magnet synchronous machine based on current decay test and particle swarm optimization*, IEEE Latin America Transactions, vol. 11, no. 5, pp. 1176–1181 (2013), DOI: [10.1109/TLA.2013.6684392](https://doi.org/10.1109/TLA.2013.6684392).
- [10] Liu Z., Wei H., Zhong Q., *Parameter estimation for VSI-Fed PMSM based on a dynamic PSO with learning strategies*, IEEE Transactions on Power Electronics, vol. 32, no. 4, pp. 3154–3165 (2017), DOI: [10.1109/TPEL.2016.2572186](https://doi.org/10.1109/TPEL.2016.2572186).
- [11] Liu Z., Wei H., Li X., *Global identification of electrical and mechanical parameters in PMSM drive based on dynamic self-learning PSO*, IEEE Transactions on Power Electronics, vol. 33, no. 12, pp. 10858–10871 (2018), DOI: [10.1109/TPEL.2018.2801331](https://doi.org/10.1109/TPEL.2018.2801331).
- [12] Sandre-Hernandez O., Morales-Caporal R., Rangel-Magdaleno J., *Parameter identification of PMSMs using experimental measurements and a PSO algorithm*, IEEE Transactions on Instrumentation and Measurement, vol. 64, no. 8, pp. 2146–2154 (2015), DOI: [10.1109/TIM.2015.2390958](https://doi.org/10.1109/TIM.2015.2390958).
- [13] Liu X., Hu W., Ding W., *Research on multi-parameter identification method of permanent magnet synchronous motor*, Transactions of China Electrotechnical Society, vol. 35, no. 6, pp. 1198–1207 (2020).
- [14] Liu C., Zhou S., Liu K., *Permanent magnet synchronous motor multiple parameter identification and temperature monitoring based on binary-modal adaptive wavelet particle swarm optimization*, Acta Automatica Sinica, vol. 39, no. 12, pp. 2121–2130 (2013), DOI: [10.3724/SP.J.1004.2013.02121](https://doi.org/10.3724/SP.J.1004.2013.02121).
- [15] Fu X., Gu H., Chen G., *Permanent magnet synchronous motors parameters identification based on Cauchy mutation particle swarm optimization*, Transactions of China Electrotechnical Society, vol. 29, no. 5, pp. 127–131 (2014).

- [16] Guo-han L., Jing Z., Zhao-hua L., Kui-yin Z., *Parameter identification of PMSM using improved comprehensive learning particle swarm optimization*, *Electric Machines and Control*, vol. 19, no. 1, pp. 51–57 (2015).
- [17] San-yang L., Ping Z., Ming-min Z., *Artificial bee colony algorithm based on local search*, *Control and Decision*, vol. 29, no. 1, pp. 123–128 (2014).
- [18] Ding X., Liu G., Du M., *Efficiency improvement of overall PMSM-Inverter system based on artificial bee colony algorithm under full power range*, *IEEE Transactions on Magnetics*, vol. 52, no. 7, pp. 1–4 (2016), DOI: [10.1109/TMAG.2016.2526614](https://doi.org/10.1109/TMAG.2016.2526614).
- [19] Zawilak T., *Influence of rotor's cage resistance on demagnetization process in the line start permanent magnet synchronous motor*, *Archives of Electrical Engineering*, vol. 69, no. 2, pp. 249–258 (2020), DOI: [10.24425/aee.2020.133023](https://doi.org/10.24425/aee.2020.133023).