

ADVANCED OXIDATION OF DICLOFENAC  
IN VARIOUS AQUATIC ENVIRONMENTS

EWA FELIS\*, JAROSŁAW WISZNIOWSKI, KORNELIUSZ MIKSCH

Silesian University of Technology, Environmental Biotechnology Department  
ul. Akademicka 2, 44-100 Gliwice, Poland

\* Corresponding author e-mail: Ewa.Felis@polsl.pl

**Keywords:** Diclofenac, Fenton's reaction, photolysis, UV/H<sub>2</sub>O<sub>2</sub>, aquatic solution.

**Abstract:** Many of the drugs used are not completely metabolized in the human body and with urine and feces are introduced into the sewage system. Finally, due to their incomplete removal during the conventional wastewater treatment process (CWTP), they can be released into the receiving water. One of the medicaments frequently detected in surface water is diclofenac. The present study addresses the problem of diclofenac removal in various aquatic samples using advanced oxidation processes (AOPs). The experiments were performed in distilled water and in biologically treated wastewater. The following AOPs were applied: Fenton's reagent, UV- and UV/H<sub>2</sub>O<sub>2</sub>-processes. The concentration of diclofenac in distilled water corresponded to the concentration of this drug in human urine (ca. 20 mg·dm<sup>-3</sup>). The real wastewater samples contained diclofenac concentrations ranging from 630 to 790 ng·dm<sup>-3</sup>. The photodegradation of diclofenac was carried out in the photoreactor with a medium pressure Hg-vapor lamp (400 W). In the Fenton's reaction different molar ratios of H<sub>2</sub>O<sub>2</sub>/Fe<sup>2+</sup> were used. The diclofenac mineralization (TOC removal) strictly depended on the amount of H<sub>2</sub>O<sub>2</sub> applied in the Fenton's reaction. Diclofenac was rapidly degraded by direct photolysis (UV) and in UV/H<sub>2</sub>O<sub>2</sub> process both in distilled water and in wastewater samples. The results proved that the advanced oxidation processes are effective in diclofenac removal from aquatic samples. The pseudo first order rate constants for diclofenac photodegradation were determined.

## INTRODUCTION

Pharmaceuticals present in the environment are at a very low concentration (ng- or µg per dm<sup>3</sup>) [7], which is generally a non-toxic level [2] and frequently undergo rapid transformation or decay. Nevertheless their ubiquitous, continuous discharge into the environment and uncertainty regarding chronic impact of residual pharmaceutical on human health makes them intrinsically key pollutants.

After administration, many drugs are extracted non-metabolized by patients and enter with urine and feces the sewage system [10]. Finally, due to incomplete removal of pharmaceuticals and their metabolites during the conventional wastewater treatment process (CWTP), they are released into the receiving water. This is the most significant entry route for pharmaceuticals into the aquatic environment [20]. Diclofenac (2-[2',6'-(dichlorophenyl)amino]phenylacetic acid) belongs to the group of analgesic agents and is classified as a non-steroidal anti-inflammatory drug. It is often used to treat inflammatory and painful diseases of rheumatic and non-rheumatic origin. The basic data

concerning diclofenac is listed in Table 1. Approximately, 3.7 Mg of the prescription drug – diclofenac is annually sold in Poland. In comparison to other analgesic substance such as ibuprofen, which is degraded in more than 90%, diclofenac removal in CWTP is rather low ranging from 20 to 40% [4–8]. Non significant improvement of diclofenac removal (to about 50%) can be obtained using the membrane bioreactor (MBR) [11]. It can be explained by a very low sorption to activated sludge flocks (sorption coefficient  $K_d$  amounted to  $1.6 \text{ dm}^3 \cdot \text{kg}^{-1}$ ), and low degradation in the biological system, i.e. the value of degradation constant  $k_{\text{biol}}$  is below  $0.1 \text{ (dm}^3 \cdot \text{g}^{-1} \cdot \text{d}^{-1})$ . According to the classification scheme proposed by Joss *et al.* [9], no substantial removal (generally below 20%) by degradation can be expected for diclofenac. Diclofenac is one of the medicaments most frequently detected in aquatic environment such as surface waters and its traces were found in drinking water [7]. Its concentration in raw municipal wastewater exceeded the level of few  $\mu\text{g} \cdot \text{dm}^{-3}$  [1, 20].

Table 1. Basic data concerning diclofenac

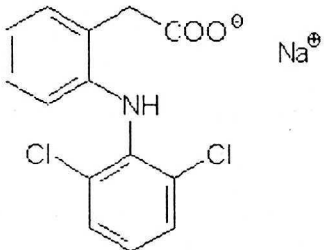
Parameter	Data
Name	Diclofenac
Molecular formula	$\text{C}_{16}\text{H}_{11}\text{Cl}_2\text{NO}_2$
Molar mass	$296.16 \text{ g} \cdot \text{mol}^{-1}$
CAS number	15307-86-5
Structural formula (sodium salt of diclofenac)	

Photochemical reaction is likely to be the most important abiotic process affecting the fate of non-biodegradable and non-sorbing pharmaceuticals in the environment. Diclofenac can be photodegraded in the surface waters by sunlight [1, 14]. For instance, even in winter conditions the half life for direct photolysis of diclofenac ( $\mu\text{g}$  level) in bi-distilled water was estimated as 5 days [1]. Recently, the degradation performance of high concentrated solutions of diclofenac ( $50 \text{ mg} \cdot \text{dm}^{-3}$ ) was proved in the pilot plant scale using compound parabolic collector [15]. The authors observed significant solar photolytic degradation reaching 85% for diclofenac solution within 62 h of operation.

The UV-based advanced oxidation processes (AOPs) have high potential for elimination of diclofenac. Some previous studies reported the use of Fenton photo-assisted treatment [15, 18],  $\text{H}_2\text{O}_2/\text{UV}$  [6, 22],  $\text{O}_3/\text{UV}$  [6] or  $\text{TiO}_2/\text{UV}$  [3, 12]. In order to prevent accumulation and unfavorable transformation of pharmaceuticals into the environment, an effective treatment technology for the removal of such compounds is indispensable. The aim of the study was to investigate the removal efficiency of diclofenac using such oxidation processes as: ultraviolet irradiation (UV), Fenton's reaction and  $\text{UV}/\text{H}_2\text{O}_2$ -process. Two approaches were tested: i) elimination of diclofenac from the treated wastewater (end-of-pipe treatment), ii) diclofenac elimination from its relatively high concentrated

solutions, which corresponded to its concentration in human urine (ca. 20 mg·dm<sup>-3</sup>). This latter is reflected in treatment processes applied for a source separated waste.

## MATERIALS AND METHODS

The experiments were performed in distilled water and biologically treated wastewater. The concentration of diclofenac in distilled water corresponded to the concentration of this drug in human urine (20 mg·dm<sup>-3</sup>). In the treated wastewater the experiments at real concentrations of diclofenac (630–790 ng·dm<sup>-3</sup>) were performed. The collected wastewater samples were taken after biological treatment from urban sewage treatment plant (STP) of Kloten (Switzerland). The detailed description of STP is presented in the references (e.g. [8]).

### *Analytical methods*

The detection of diclofenac in the biologically treated wastewater was performed by gas chromatography/mass spectrometry (GC/MS) after solid phase extraction (SPE) and derivatisation by a diazomethane/diethylether – solution. After the reaction time, the diazomethane was destroyed by adding the acidic acid/acetone solution (1:10, v/v). Prior to SPE the wastewater samples were filtered, acidified with sulphuric acid to pH 2 and a surrogate standard (Br-diclofenac) was added. PCB nr 30 as an internal standard was used. The analytical standards were purchased from Sigma-Aldrich. The GC/MS measurements were performed on a gas chromatograph HP 5890 (equipped with autosampler HP 7673), coupled with the mass spectrometer HP 5971. The Restek XTI – 5 (30 m x 0.25 mm x 0.25 µm) as GC – column was used. The limit of detection (LOD) of diclofenac in the treated wastewater samples was at the level of 0.02 µg·dm<sup>-3</sup>. All GC/MS analyses were performed in a single-ion monitoring (SIM) mode, according to the methods concerning acidic drugs determination proposed by Ternes [19] and Ternes *et al.* [21]. The diclofenac concentrations in the distilled water were confirmed by high performance liquid chromatography (HPLC) (HPLC-UVD 340u, Gynkotek). The LichroCard 250-4 (Lichrospher 100, Merck) as the HPLC – column was used. The acetonitrile and phosphate buffer (5 mmol K<sub>2</sub>HPO<sub>3</sub>, adjusted with H<sub>3</sub>PO<sub>4</sub> to pH 3) in a ratio of 60:40 (v/v) was applied as a mobile phase. The acetonitrile used for the experiments was of the highest commercially available, grade and it was purchased from POCH – Gliwice (Poland). A flow rate of mobile phase was 1 cm<sup>3</sup>·min<sup>-1</sup> and the detection wavelength was set at 220 nm. Under the conditions described, the retention time (RT) of diclofenac was equal 6.8 ± 0.1 min. An external standard method was used for diclofenac determination in distilled water. The limit of quantification (LOQ) was set at first at the lowest point of linear calibration while the ratio signal/noise (S/N) exceeded the value 10 (S/N > 10). The concentration of total organic carbon (TOC) during all experiments was controlled using total carbon analyzer TOC-V<sub>CSH</sub> (Shimadzu).

### *Experiments set up*

The following advanced oxidation processes (AOPs) were used: Fenton's reaction, photolysis (UV) and photolysis accelerated with hydrogen peroxide (UV/H<sub>2</sub>O<sub>2</sub>) in oxidation of diclofenac. The Fenton's reagent was applied only for oxidation of the diclofenac solution. The solution was prepared by dissolving 20 mg·dm<sup>-3</sup> of diclofenac in distilled

water (HPLC grade). The oxidation by means of Fenton's reagent was performed in the glass reactor (volume of 1 dm<sup>3</sup>). The solution in the reactor was slowly stirred during the experiment and sampled after definite times (1, 2, 5, 10, 15, 20, 30, 45 and 60 min). In the Fenton's reagent different molar ratios of H<sub>2</sub>O<sub>2</sub>/Fe<sup>2+</sup> (0.3/1; 0.6/1 and 1.2/1) were used. The pH of solution was adjusted with sulphuric acid to pH 3. The amount of H<sub>2</sub>O<sub>2</sub> was estimated basing on the COD of diclofenac solution, according to the equation (1).

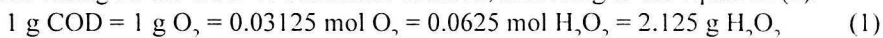

The photochemical investigations were carried out in the reactor UviLab P400 (VitaTec, Germany). The biologically treated wastewater and distilled water spiked with diclofenac standard as experimental matrices were used. In the photochemical processes the system was operated as a plug-flow reactor (Fig. 1a) or as a circulation loop (Fig. 1b). A medium-pressure mercury lamp (P = 400 W) in quartz casing was immersed in the glass reactor (V = 0.350 dm<sup>3</sup>). All experiments were performed using half of the maximal lamp power (P = 200 W). The average path length of light through the solution was equal 10 mm. In the UV/H<sub>2</sub>O<sub>2</sub> experiments the overdosed concentrations of H<sub>2</sub>O<sub>2</sub> were applied – 1 g H<sub>2</sub>O<sub>2</sub>·dm<sup>-3</sup> in the case of distilled water spiked with diclofenac standard and 1 mg·dm<sup>-3</sup> in the case of the treated wastewater. The pH of the experimental matrices was adjusted to 7. The photochemical investigation was performed at the ambient temperature (ranging from 23 to 25°C). Reported values were the average of 3 replicates.

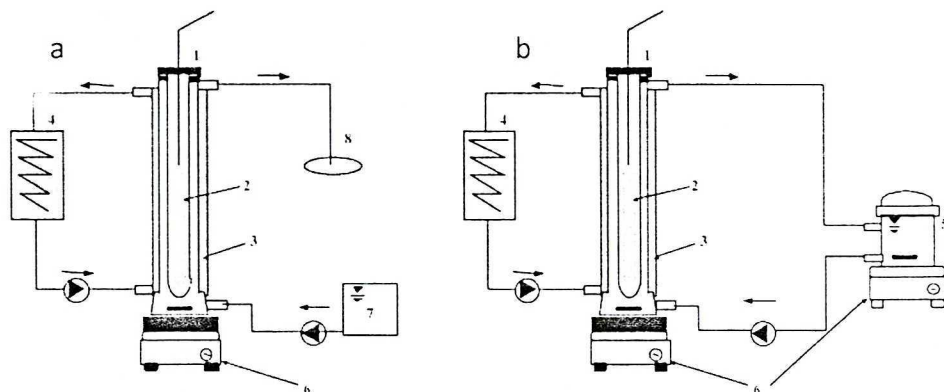

Fig. 1. Schematic diagram of photocatalytic set-up: a) plug-flow reactor, b) circulation loop mode; 1 – photoreactor, 2 – UV-lamp, 3 – cooling (jacket) loop, 4 – refrigerated bath circulator, 5 – indirect (mix) chamber, 6 – magnetic stirrers, 7 – wastewater influent, 8 – wastewater effluent

## RESULTS AND DISCUSSION

### *Fenton's reagent*

For the diclofenac solution (20.0 mg·dm<sup>-3</sup>), the average concentration of TOC amounted to 11.4 mg C·dm<sup>-3</sup> and COD was equal 35.0 mg O<sub>2</sub>·dm<sup>-3</sup>. After the pH correction with sulphuric acid to the value of 3, a considerable elimination of diclofenac concentration was observed. It ranged from 35.0 to 47.0% of the initial diclofenac concentration. The decrease of diclofenac concentration in the solution at pH = 3 could have been caused by the partial diclofenac precipitation. Diclofenac is weak acid (pK<sub>a</sub> = 4.15), soluble in its

deprotonised form, but practically insoluble when it is protonised. As reported by Perez-Estrada *et al.* [15] the similar diclofenac behavior at acidic pH was observed. Prior to HPLC-analysis all samples were filtered and partially precipitated diclofenac (including the chemical sludge originated from Fenton's process) remained on the glass fiber filter. The elimination of TOC from diclofenac solution as a consequence of pH decreasing varied from 18 to 32%.

Consequently, the removal of diclofenac with Fenton's reagent at pH around 3, should be summarized as oxidation, the precipitation and re-dissolution processes occurred simultaneously in the reaction mixture [15]. Irrespective of  $\text{H}_2\text{O}_2/\text{Fe}^{2+}$  ratio used in the Fenton's reagent, above 90% of diclofenac disappearance within 1 min was observed (Fig. 2). In the result of the oxidation with Fenton's reagent the concentrations of TOC in the diclofenac solution were reduced. The dependency between the concentration of  $\text{H}_2\text{O}_2$  in the Fenton's reagent and the efficiency of the TOC-removal was noticed (Fig. 3). The maximal TOC removal (ca. 75%) was achieved when a molar ratio of  $\text{H}_2\text{O}_2/\text{Fe}^{2+}$  used in a Fenton's reagent amounted to 0.6/1.0. When the ratio  $\text{H}_2\text{O}_2/\text{Fe}^{2+}$  was 0.3/1.0, the TOC removal did not exceed the value of 35%. It should be noted that significant changes of diclofenac concentrations can be noticed already within the few first minutes of the process.

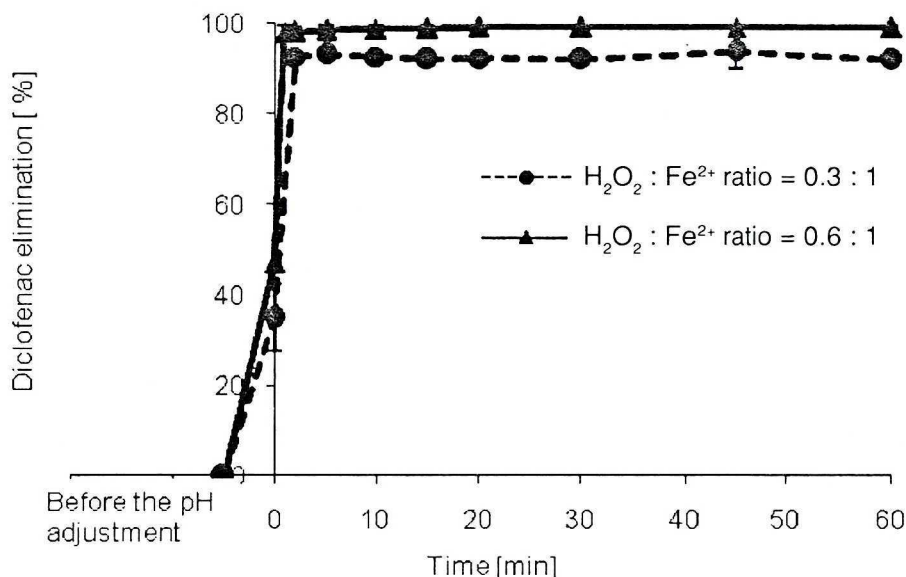

Fig. 2. Diclofenac removal during the Fenton's reaction (performed in water)

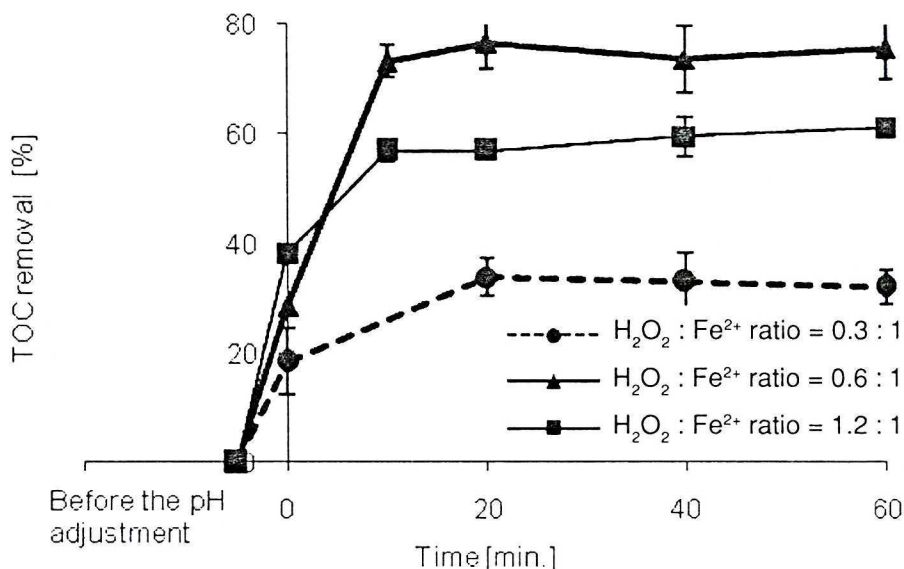

Fig. 3. Removal of TOC during Fenton's reaction (performed in water)

#### *Diclofenac photodegradation in water (UV- and UV/H<sub>2</sub>O<sub>2</sub>-processes)*

Diclofenac has the maximum absorbance at 273 nm, but also can absorb irradiation from a broad UV-range and partly in the solar region (Fig. 4). The initial concentration of diclofenac in the distilled water amounted to 20.0 mg·dm<sup>-3</sup> (TOC = 11.4 mg·dm<sup>-3</sup>). The Figure 5 depicts the removal percentages of diclofenac in water recorded in the experiments with the UV-radiation and in the UV/H<sub>2</sub>O<sub>2</sub>-process. The 45% of diclofenac removal with reference to its initial concentration after 1 min of the UV-process was observed. After 5 min of UV-process, the initially colorless diclofenac solution changed into red-brown color. A new peak with RT of 1.86 min appeared on the chromatogram (data not shown). The peak was not successfully identified. On the chromatogram the peak with RT = 1.86 min was still present to the end of the irradiation time (30 min). The diclofenac concentration after 15 min of irradiation reached level below of LOQ. The coloration of diclofenac solution during the UV-process can be caused by the formation of the diclofenac photoproducts. Petrovic and Barceló [16] identified by means of LC-TOF-MS the diclofenac photoproduct with quinone-imine structures. Other possibility is a formation of the principal products, carbazole derivatives, generated due to the diclofenac dechlorination and formation of an inter-ring carbon bond [13, 17]. The carbazole structure is an active chromophore absorbing visible light. The appearance of specific red-brown color under solar irradiation of diclofenac was reported by Perez-Estrada *et al.* [15].

In the case of UV/H<sub>2</sub>O<sub>2</sub>-process, the addition of H<sub>2</sub>O<sub>2</sub> (1.0 g·dm<sup>-3</sup>) brought about the diclofenac decomposition by 9%. After 1 min of operation, the diclofenac removal exceeded 60%. The specific red-brown color of diclofenac solution appeared after 5 min of UV/H<sub>2</sub>O<sub>2</sub>-process. In the same time the peak with RT = 1.86 min was observed on the chromatogram. The diclofenac removal exceeded 97% and after another 5 min of the process (irradiation time = 10 min) its concentration was below LOQ. The decoloration of experimental solution after approximately 15 min of the UV/H<sub>2</sub>O<sub>2</sub>-process was observed.

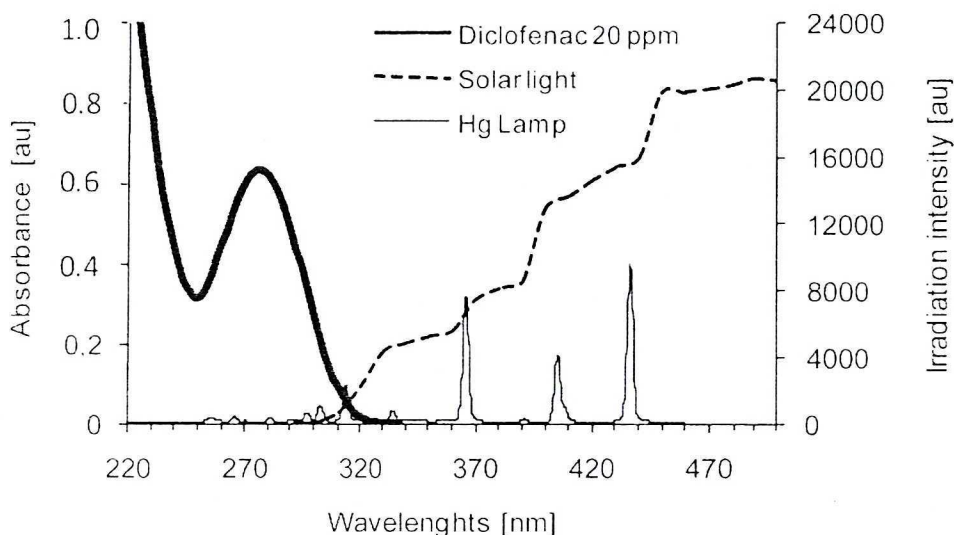

Fig. 4. Diclofenac absorbance spectrum in water (pH = 7) with reference to solar and medium pressure Hg-lamp emission spectra

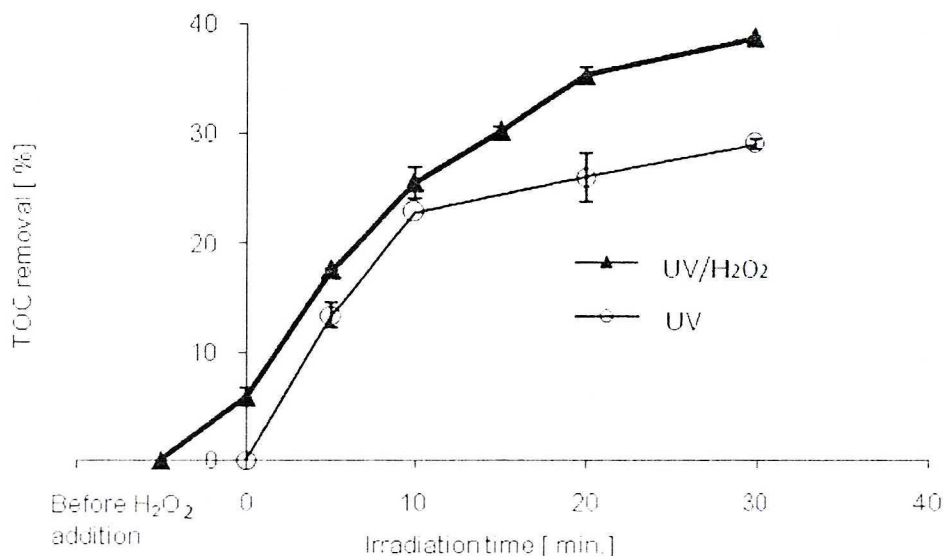

Fig. 5. Diclofenac removal by means of the UV- and UV/H<sub>2</sub>O<sub>2</sub>-processes in water

In the same time, on the chromatogram, the peak at RT = 1.86 min was not present. It suggests that in the UV/H<sub>2</sub>O<sub>2</sub>-process not only the diclofenac molecules, but also the molecules of the diclofenac by-product were decomposed. The addition of H<sub>2</sub>O<sub>2</sub> in the UV-process probably caused the cleavage of carbon ring in the diclofenac derivatives and leads to the carboxylic acid formation *via* the classic degradation pathways [22]. For diclofenac oxidation by means of UV-radiation and in the UV/H<sub>2</sub>O<sub>2</sub>-process the pseudo

first order rate constants ( $k$ ) were calculated (Tab. 2). The addition of  $H_2O_2$  by diclofenac irradiation with UV caused 1.6-times acceleration of its decay with comparison to the decay in the absence of  $H_2O_2$ . After 5 min of diclofenac photolysis, the TOC-removal exceeded 13% and after next 5 min of the process the TOC-removal reached 23%. TOC removal after 30 min of irradiation was at the level of 30%. The TOC removal after 5 min of UV/ $H_2O_2$ -process was at the level of 17%. After 30 min of this process, near by 40% TOC removal was noticed (Fig. 6).

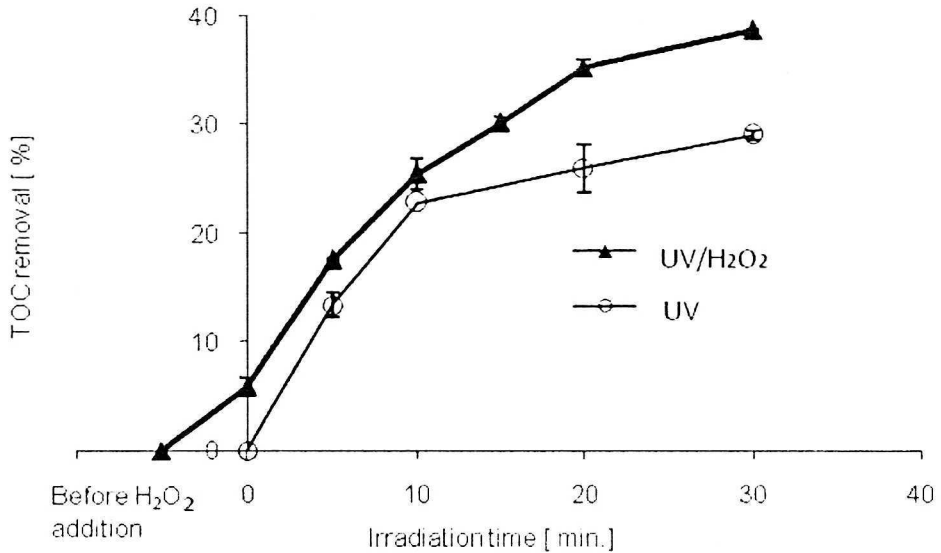

Fig. 6. TOC removal during diclofenac oxidation using the UV- and UV/H<sub>2</sub>O<sub>2</sub>-processes in water

Table 2. Pseudo first order kinetic constants ( $k$ ) of diclofenac photodegradation in water

Process	$k$ [min <sup>-1</sup> ]	R <sup>2</sup>
UV	0.449	0.984
UV/H <sub>2</sub> O <sub>2</sub>	0.716	0.986

### ***Diclofenac photodegradation in wastewater (UV- and UV/H<sub>2</sub>O<sub>2</sub>-processes)***

The diclofenac concentration in the biologically treated wastewater varied from 630–790 ng·dm<sup>-3</sup>, while the average COD of wastewater during the whole experimental period was equal to 29.0 mg·dm<sup>-3</sup>. Considering the low diclofenac concentrations in the treated wastewater, the degradation of this compound by means of UV-radiation and in the UV/ $H_2O_2$  proceeded very rapidly in the both cases.

After 1 min of diclofenac photolysis and in the UV/ $H_2O_2$ -process the diclofenac removals were at the level of 79% and 83%, respectively. Complete diclofenac decay (the concentration below of LOD) was obtained within 2 min of UV/ $H_2O_2$ -process and within 3 min of UV-irradiation (Fig. 7). Due to the specific color of wastewater matrix and a very low concentration of diclofenac, no apparent color variation (resulting from a generation of diclofenac by-products) could be distinguished. The pseudo first order rate constants ( $k$ ) are presented in Table 3. The calculated kinetic constant for diclofenac decay in the



UV/H<sub>2</sub>O<sub>2</sub>-process was equal to 1.78 min<sup>-1</sup> and this value was only 1.05-folds higher than kinetic constant determined for UV-process (without H<sub>2</sub>O<sub>2</sub> addition).

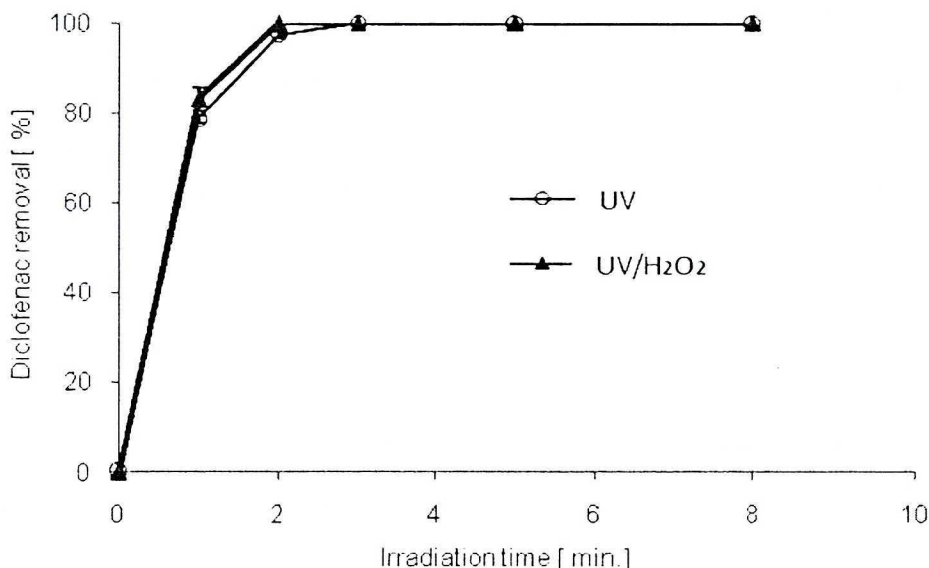

Fig. 7. Diclofenac removal by means of UV- and UV/H<sub>2</sub>O<sub>2</sub>-processes in wastewater

Table 3. Pseudo first order kinetic constants (*k*) of diclofenac photodegradation in wastewater

Process	<i>k</i> [min <sup>-1</sup> ]	R <sup>2</sup>
UV	1.694	0.995
UV/H <sub>2</sub> O <sub>2</sub>	1.780	0.910

In the wastewater the H<sub>2</sub>O<sub>2</sub> addition accelerated the diclofenac decomposition rate, but the positive effect was not so obvious in comparison with the results of experiments performed in the distilled water (at higher concentration of diclofenac). This result can partly be explained by a composition of wastewater samples (solution matrix), which could strongly influence the performance of photochemical processes. It is widely accepted that carbonate/bicarbonate anions act as the effective OH<sup>•</sup> radical scavengers. Consequently, the ions present in the wastewater, such as HCO<sub>3</sub><sup>-</sup>/CO<sub>3</sub><sup>2-</sup>, could deactivate the reactive intermediates of oxygen generated during the H<sub>2</sub>O<sub>2</sub> photolysis. This phenomenon merits a closer examination using the diclofenac solution. On the other hand, matrix of wastewater did not affect direct photolysis of diclofenac molecules.

### CONCLUSION

In the case of diclofenac oxidation with Fenton's reagent irrespective of H<sub>2</sub>O<sub>2</sub>/Fe<sup>2+</sup> ratio, above 90% of diclofenac disappearance within 1 min of the process was observed. The maximal TOC removal (75%) was achieved when a molar ratio of H<sub>2</sub>O<sub>2</sub>/Fe<sup>2+</sup> used in a Fenton's reagent was equal to 0.6/1.0. The decrease of diclofenac concentration (from

35.0 to 47.0% of the initial concentration) after pH adjustment to 3 can be attributed to the partial precipitation of this compound. The removal of diclofenac by means of Fenton's reagent (at pH = 3) should be perceived not only as advanced oxidation process but also as simultaneously occurred processes including oxidation, precipitation and re-dissolution diclofenac in the reaction mixture.

The kinetic calculated on the basis of the results of photochemical experiments' constants indicated that the addition of hydrogen peroxide accelerated the rate of diclofenac disappearance. In the case of the investigation performed in water, the addition of hydrogen peroxide accelerated the diclofenac decay rate from the value  $k = 0.440 \text{ min}^{-1}$  (without  $\text{H}_2\text{O}_2$ ) to the value  $k = 0.716 \text{ min}^{-1}$  (in the presence of  $\text{H}_2\text{O}_2$ ).

The obtained results proved that advanced oxidation processes (AOPs) are effective in diclofenac removal from the aquatic samples and the UV/ $\text{H}_2\text{O}_2$ -process can play a significant role in diclofenac removal from the aquatic environment, for instance as tertiary treatment (polishing stage) after the biological wastewater treatment.

#### Acknowledgements

The authors gratefully acknowledge the financial support provided by Polish research project 4 T09C05225 and EU project DEMETER (EVK1-CT62002-80009).

#### REFERENCES

- [1] Andreozzi R., M. Raffaele, P. Nicklas: *Pharmaceuticals in STP effluents and their solar photodegradation in aquatic environment*, Chemosphere, **50**, 1319–1330 (2003).
- [2] Bound P., N. Voulvoulis: *Pharmaceuticals in the aquatic environment — a comparison of risk assessment strategies*, Applied Catalysis B: Environmental, **67**, 197–205 (2006).
- [3] Calza P., V.A. Sakkas, C. Medana, C. Baiocchi, A. Dimou, F. Pelizzetti, T. Albanis: *Photocatalytic degradation study of diclofenac over aqueous  $\text{TiO}_2$  suspensions*, Chemosphere, **45**, 957–969 (2001).
- [4] Clara M., B. Strenn, N. Kreuzinger: *Carbamazepine as possible anthropogenic marker in the aquatic environment: investigation on the behavior of Carbamazepine in wastewater treatment and during ground-water infiltration*, Water Research, **38**, 947–954 (2004).
- [5] Clara M., B. Strenn, O. Gans, E. Martinez, N. Kreuzinger, H. Kroiss: *Removal of selected pharmaceuticals, fragrances and endocrine disrupting compounds in a membrane bioreactor and conventional wastewater treatment plants*, Water Research **39**, 4797–4807 (2005).
- [6] Gebhardt W., H.F. Schroder: *Liquid chromatography–(tandem) mass spectrometry for the follow-up of the elimination of persistent pharmaceuticals during wastewater treatment applying biological wastewater treatment and advanced oxidation*, Journal of Chromatography A, **1160**, 34–43 (2007).
- [7] Heberer T.: *Occurrence, fate, and removal of pharmaceutical residues in the aquatic environment: a review of recent research data*, Toxicology Letters, **131**, 5–17 (2002).
- [8] Joss A., E. Keller, A. Alder, A. Goebel, C. McArdell, T.A. Ternes, H. Siegrist: *Removal of pharmaceuticals and fragrances in biological wastewater treatment*, Water Research, **39**, 3139–3152 (2005).
- [9] Joss A., S. Zabczynski, A. Göbel, B. Hoffmann, D. Löffler, C. McArdell, T.A. Ternes, A. Thomsen, H. Siegrist: *Biological degradation of pharmaceuticals in municipal wastewater treatment: Proposing a classification scheme*, Water Research, **40**, 1686–1696 (2006).
- [10] Kümmerer K.: *Drugs in the environment: emission of drugs, diagnostic aids and disinfectants into wastewater by hospitals in relation to other sources – a review*, Chemosphere, **56**, 1143–1155 (2004).
- [11] McArdell C., A. Alder, M. Clara, A. Goebel, A. Joss, E. Keller, N. Kreuzinger, H. Pluess, H. Siegrist, B. Strenn: *Impact of treatment technologies on the elimination of selected pharmaceuticals from wastewater*, [in:] SETAC Europe Meeting, Prague, Czech Republic 2004.
- [12] Méndez-Arriaga F., S. Esplugas J. Giménez: *Photocatalytic degradation of non-steroidal anti-inflammatory drugs with  $\text{TiO}_2$  and simulated solar irradiation*, Water Research, **42**, 585–594 (2008).
- [13] Moore D.E., S. Roberts-Thomson, D. Zhen, C. Duke: *Photochemical studies on the anti-inflammatory drug diclofenac*, Photochemistry and Photobiology, **52**, 685–690 (1990).

- [14] Packer J., J. Werner, D. Latch, K. McNeill, W. Arnold, *Photochemical fate of pharmaceuticals in the environment: Naproxen, diclofenac, clofibric acid and ibuprofen*, *Aquatic Science*, **65**, 342–35 (2003).
- [15] Perez-Estrada L., M. Maldonado, W. Gernjak, A. Aguera, A. Fernandez-Alba, M. Ballesteros, S. Malato: *Decomposition of diclofenac by solar driven photocatalysis at pilot plant scale*, *Catalysis Today*, **101**, 219–226 (2005).
- [16] Petrovic M., D. Barceló: *LC-MS for identifying photodegradation products of pharmaceuticals in the environment*, *Trends in Analytical Chemistry*, **26**, 486–493 (2007).
- [17] Poiger T., H. Buser, M. Müller: *Photodegradation of the pharmaceutical drug diclofenac in a lake: pathway, field measurements and mathematical modeling*, *Environmental Science and Technology*: **20**, 256–63 (2001).
- [18] Ravina M., L. Campanella, J. Kiwia: *Accelerated mineralization of the drug Diclofenac via Fenton reactions in a concentric photo-reactor*, *Water Research*, **36**, 3553–3560 (2002).
- [19] Ternes T.A.: *Analytical methods for the determination of pharmaceuticals in aqueous environmental samples*, *Trends in Analytical Chemistry*, **20**, 419–430 (2001).
- [20] Ternes T.A.: *Occurrence of drugs in German sewage treatment plants and rivers*, *Water Research*, **32**, 3245–3260 (1998).
- [21] Ternes T.A., M. Bonerz, N. Herrmann, E. Keller, B. Bago, A. Alder: *Determination of pharmaceuticals, iodinated contrast media and musk fragrances in sludge and water via LC tandem MS and GC/MS*, *Journal of Chromatography*, **1067**, 213–223 (2005).
- [22] Vogna D., R. Marotta, A. Napolitano, R. Andreozzi, M. d'Ischia: *Advanced oxidation of the pharmaceutical drug diclofenac with UV/H<sub>2</sub>O<sub>2</sub> and ozone*, *Water Research*, **38**, 414–422 (2004).

Received: August 5, 2008; accepted: March 12, 2009.

#### ZAAWANSOWANY ROZKŁAD DIKLOFENAKU W ŚRODOWISKU WODNYM

Większość farmaceutyków stosowanych w medycynie nie ulega całkowitemu zmetabolizowaniu w ciele pacjenta i wraz z moczem i kałem trafia do systemu kanalizacyjnego. Ze względu na swe właściwości, nie są one całkowicie usuwane ze ścieków w konwencjonalnych procesach oczyszczania ścieków i wraz ze ściekami oczyszczonymi mogą przedostawać się do odbiorników. Diklofenak jest lekiem często identyfikowanym w wodach powierzchniowych. Prezentowane w niniejszej publikacji badania dotyczą problemu usuwania diklofenaku ze środowiska wodnego za pomocą zaawansowanych procesów utleniania (ang. advanced oxidation processes, AOPs). Badania prowadzono w roztworach wodnych diklofenaku (przygotowanego z wykorzystaniem wody destylowanej) oraz w ściekach po biologicznym procesie oczyszczania. W badaniach zastosowano następujące techniki AOPs: utlenianie odczynnikiem Fentona, utlenianie za pomocą promieniowania UV oraz proces UV/H<sub>2</sub>O<sub>2</sub>. Stężenie diklofenaku odpowiadało stężeniom, jakich można spodziewać się w moczu pacjenta podczas kuracji tym lekiem (20 mg·dm<sup>-3</sup>). Ścieki oczyszczone zawierały diklofenak na poziomie 630–790 ng·dm<sup>-3</sup>. Badania z wykorzystaniem promieniowania UV prowadzono w fotoreaktorze wyposażonym w średniociśnieniową lampę rtęciową (400 W). Utlenianie za pomocą odczynnika Fentona prowadzono przy różnych stosunkach molowych H<sub>2</sub>O<sub>2</sub>/Fe<sup>2+</sup>. Mineralizacja diklofenaku (określana jako usunięcie OWO) bezpośrednio zależała od ilości H<sub>2</sub>O<sub>2</sub> w odczynniku Fentona stosowanego podczas badań. Diklofenak ulegał szybkiemu rozkładowi za pomocą promieniowania UV i w procesie UV/H<sub>2</sub>O<sub>2</sub>, zarówno w roztworze wodnym tego leku jak i w próbkach ścieków. Wyniki przeprowadzonych badań wskazują, iż zastosowanie zaawansowanych procesów utleniania w znacznym stopniu zwiększa efektywność usuwania diklofenaku ze środowiska wodnego. W ramach niniejszych badań obliczone zostały pseudo pierwszorzędowe stałe szybkości rozkładu diklofenaku przy zastosowaniu metod fotochemicznych.