

DOI: <https://doi.org/10.24425/amm.2022.141047>M.A. PLATON<sup>1</sup>, O. NEMEȘ<sup>1,4\*</sup>, A.-E. TIUC<sup>1</sup>, C. VILĂU<sup>2</sup>, C.M. DUDESCU<sup>2</sup>, S. PĂDUREȚU<sup>3</sup>

## THE INFLUENCE OF PROCESS PARAMETERS ON THE MECHANICAL BEHAVIOR OF A COMPOSITE MATERIAL MADE FROM MIXED PLASTIC WASTES

Accordingly with the principles of the circular economy, mixed plastic wastes can be recycled also by thermoforming, getting new non-oriented fibers composite materials. This study highlights the mechanical behavior of new composite material plates containing recycled glass fibers as reinforcing element and ABS-PMMA mixture as matrix, as well as an efficient way to convert a manufacturing process wastes in a product. The mechanical behavior of new composite material plates was evidenced by tensile, flexural and compression tests. In addition a surface morphology analysis was performed.

*Keyword:* mixed waste; waste recycling; sustainability

### 1. Introduction

Polymethyl-methacrylate (PMMA) and Acrylonitrile butadiene styrene (ABS) are polymers widely used in various industries such as auto-motive, aero-spatial, sanitary products, etc. The Glass Fiber Reinforced Polymers (GFRP) quantity is increasing, and its disposal is becoming an issue no longer accepted under the concept of circular economy, which states that the loop must be closed for any Fiber Reinforced Polymers (FRP) products. GFRP based materials can handle high structural load and they are an alternative to conventional materials.

To recycle the FRP wastes, some recycling methods as chemical, mechanical, thermal, and comprehensive recovery [1-4] as well as filler in concrete and mortars [5-8] are developed.

Correia et al. [9] claim that landfilling is the least preferable option and countries like Germany have already forbidden composite landfilling. Correia reported worsened concrete mechanical behavior and durability-related properties and advice to use lower quantities of GFRP mainly for non-structural applications, where mechanical properties are not of primary importance.

Titarelli and Shah [10] studied the mechanical behavior of mortar and concrete using a GFRP waste powder to replace the sand in cement mortars. The conclusion was that a low quantity of GFRP waste powder generates a lower mechanical behavior,

particularly when wet curing conditions are used. In another study, Titarelli [11] observed that by replacing 0 ÷ 5% of natural silica sand with GFRP powder in mortars it causes an increasing in mortars durability and can be considered a viable technological solution for GFRP recycling.

Asokan et al. [12] claim that using GFRP waste in concrete will lead to cost saving, since waste handling, transport, storage, and landfill tax are not necessary anymore. An approximation shows that when GFRP substitutes sand, the savings in quantity will amount to 15%.

Yazdanbakhsh et al. [13] shows the energy needed for mechanical recycling is 0.5 ÷ 5% of that needed for chemical recycling and 0.4 ÷ 16% of the energy needed for pyrolysis (thermal recycling).

Feih et al. [14] concluded that a temperature above 450°C, used in conventional thermal recycling, will lead to a 40% decrease in strength for single fiber and 80% for fiber bundles. Incineration of GFRP waste has two main disadvantages, even if it is still widely used. Firstly, during the incineration, the glass fibers will lose in strength [15], and later will melt, which causes other damage to the burning installations.

Ribeiro et al. [16] show that even if the incineration will recover part of the energy of the GFRP waste, air pollution resulting from incineration is still an important disadvantage.

<sup>1</sup> TECHNICAL UNIVERSITY OF CLUJ-NAPOCA, FACULTY OF MATERIALS AND ENVIRONMENTAL ENGINEERING, 28 MEMORANDUMULUI STREET, 400114, CLUJ-NAPOCA, ROMANIA.

<sup>2</sup> TECHNICAL UNIVERSITY OF CLUJ-NAPOCA, FACULTY OF AUTOMOTIVE, MECHATRONICS AND MECHANICAL ENGINEERING, 28 MEMORANDUMULUI STREET, 400114, CLUJ-NAPOCA, ROMANIA.

<sup>3</sup> TECHNICAL UNIVERSITY OF CLUJ-NAPOCA, FACULTY OF MACHINE BUILDING, 28 MEMORANDUMULUI STREET, 400114, CLUJ-NAPOCA, ROMANIA.

<sup>4</sup> NATIONAL INSTITUTE FOR RESEARCH AND DEVELOPMENT IN ENVIRONMENTAL PROTECTION, 294 BLVD. SPLAIUL INDEPENDENTEI, SECTOR 6, 060031, BUCHAREST, ROMANIA.

\* Corresponding author: [ovidiu.nemes@imadd.utcluj.ro](mailto:ovidiu.nemes@imadd.utcluj.ro)



European environmental legislation discourage incineration. Jensen et al. [17] shows that an inconvenient in GFRP recycling is represented by the different sizes and shapes of the waste, an aspect which makes it difficult to have a standardized process. GFRP recycling in terms of retrieving the original materials with original properties is hard to obtain.

Job [18] considers that in the last years the desire for recycling GFRP is increasing in the companies; before reasons which are both economical (landfill is increasing in price) and environmental. However, it is obvious that every recycling GFRP method bears some disadvantages. Chemical ways of recycling are at a higher cost due to less recycled GFRP in comparison with Carbon Fiber Reinforced Plastic (CFRP). By adding GFRP waste into various compounds, the mechanical properties decrease, and the behavior becomes unpredictable.

The GFRP waste available on the market is in greater quantity than the CFRP waste [19-21] and it is estimated that in near future the GFRP waste quantity will increase. An important supplier is the wind turbine industry, where a blade end-of-life is 20 years, and according to European Energy strategy in 2020 the main goal is to achieve 20% of energy through renewable energy [22] this will lead to an increasing of wind parks. End of Life Vehicles directive aims at the making, dismantling, and recycling of vehicles to become more environmentally friendly [23,24].

It is obviously necessary to develop new energy-saving methods, more energy efficient than thermal recycling and less pollutant than incineration, which enable obtaining new materials with improved mechanical behavior. In the context of circular economy, the trend is more and more waste should gain added value and close the loop – a better solution than comprehensive recovery. Nonetheless managing waste represents a design challenge and future products should be redesigned to be re-used in the current shape and at the same time remanufacturing and recycling should become more facile [25-28].

Our research is focused on molding GFRP waste chips into new structures to integrate them in an industrial production cycle and replace a different wood structure, Low Density Fiberboard (LDF). Also, the GFRP waste mixed with other wastes or materials can be used as phono absorbent material as our previously studies showed [29-31].



(a)

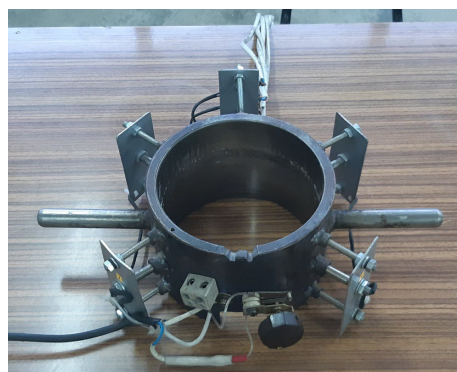

(b)



(c)

## 2. Materials and methods

### 2.1. Materials

The waste used consists of fiberglass chips mixed with a thermoplastic material (Fig. 1a). We mention that the thermoplastic material, from the mixture, is a laminate that has a composition of 90% ABS and 10% PMMA and comes from the manufacturing process of swimming pools and bathtubs. Glass fiber consists of chopped roving pieces with a length of  $8 \div 10$  mm. In the new material with non-oriented fibers composite material, the glass fiber is the reinforcement and ABS, PMMA is the matrix. For each sample molded 150 grams of waste were used, to obtain plates with the diameter of 142 mm and thickness of 10 mm (Fig. 1c).

### 2.2. Thermoforming

The molding system used is shown in Fig. 1b. With cylindrical shape and two plates mounted on both sides, the molding system is designed to heat the material in both directions through an Electrical Resistance Heating (ERH) embedded. Working pressure varies between  $3.17 \div 9.55$  MPa and temperature between  $130 \div 150^\circ\text{C}$ , as shown in TABLE 1. For the mechanical test comparison, samples from LDF board were used.

TABLE 1

Process parameters

Sample No	Sample code	Temperature [°C]	Pressure [MPa]
1	T130_P317	130	3.17
2	T130_P445	130	4.45
3	T135_P317	135	3.17
4	T135_P445	135	4.45
5	T135_P637	135	6.37
6	T140_P637	140	6.37
7	T150_P317	150	3.17
8	T150_P637	150	6.37
9	T150_P955	150	9.55

Fig. 1. Materials and equipment: (a) GFRP waste chips; (b) Molding system [28,32]; (c) GFRP sample plate for tests

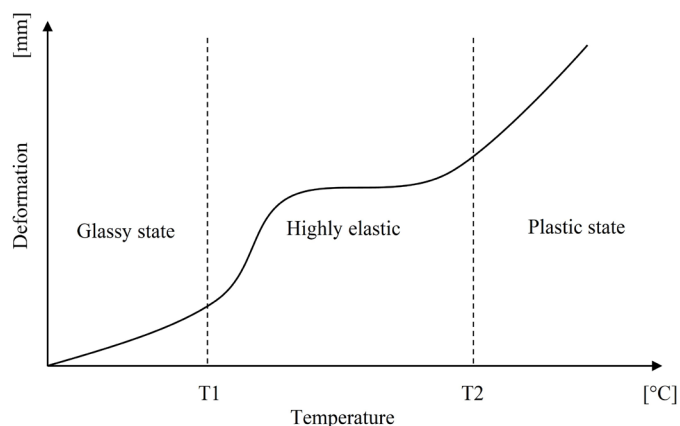

Fig. 2. Deformation versus temperature of a thermoplastic material [33]

The working temperature range was set by taking into consideration the glass transition temperature of the constituents 105°C (for ABS and PMMA), to operate on the highly elastic zone (Fig. 2), and melting point (204 ÷ 238°C for ABS, 130°C for PMMA), to prevent the main constituent (ABS) melting in the molding system.

Each sample was given a code that represents process parameters, temperature (T) and pressure (P), as shown in TABLE 1.

The behavior of studied material is directly related to its fundamental constituents – polymers, glass fiber and microstructure. The tests were carried out on rectangular specimens, with shapes like in Fig. 3, and dimensions specified in TABLE 2, for the purpose of reliable mechanical characterization and a statistical study for a better understanding of the behavior. Nine specimens were used to perform the mechanical tests.

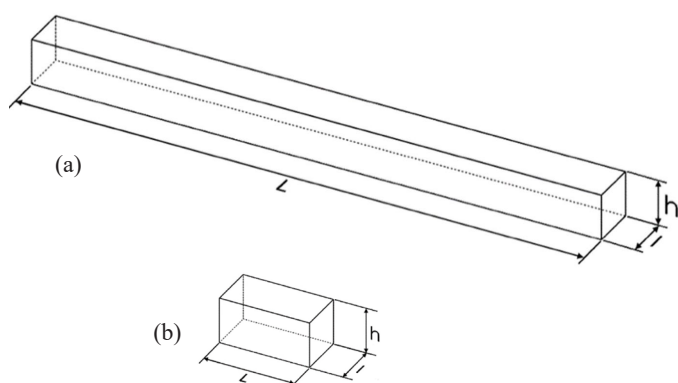

Fig. 3. Shape of test specimens: (a) Flexural/tensile specimen; (b) Compression specimen

TABLE 2

Specimen dimensions

Mechanical test	h [mm]	l [mm]	L [mm]
Tensile	10	10	125
Flexural	10	10	125
Compression	10	10	20

### 3. Results and discussion

The mechanical behavior of the new composite material plates described in this work was accomplished through mechanical tests as tensile, flexural and compression tests. The characterization of the obtained plates was completed by a morphological study.

#### 3.1. Mechanical tests

Flexural, tensile and compression tests were performed on testing equipment as shown in Fig. 4. Those tests were performed using an Instron 3366 machine to determine the mechanical behavior of the GFRP plates compared to LDF plates. The used standards are presented in TABLE 3.

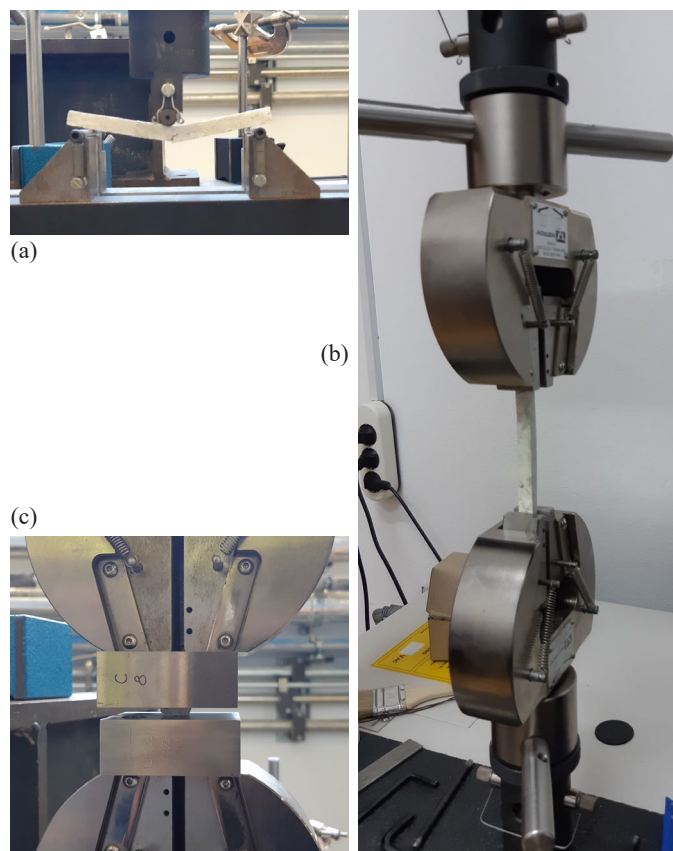

Fig. 4. Testing equipment for: (a) flexural test; (b) tensile test; (c) compression test

TABLE 3

Used standards

Mechanical test	Standard used
Flexural	ASTM D7264 / D7264M-15 [34]
Tensile	ASTM D3039 / D3039M-17 [35]
Compression	ASTM D3410 / D3410M-16 [36]

The results obtained after performing mechanical tests consist in values for stress, strain, load, and stress-strain curve.

The research focuses on failure stress ( $\sigma$ ) which is defined by the formula:

$$\sigma = F/A \quad (1)$$

Where:  $F$  = Load and  $A = h \times l$  (specimen dimensions).

### 3.1.1. Results for tensile test

The results of tensile test, Fig. 5, were arranged in the chart from left to right following a constant pressure parameter while temperature is increasing.

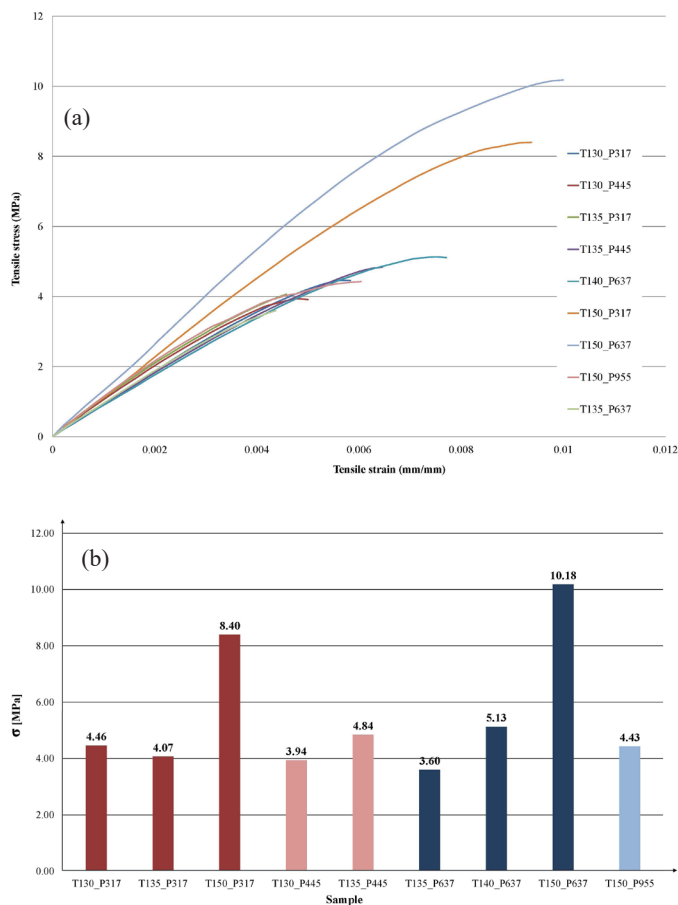

Fig. 5. Tensile test. a) Stress-strain diagram; b) Fracture tensile stress

We can observe that when pressure remains constant (317 MPa for samples 1 ÷ 3), temperature induces a better tensile behavior. Also, this can be noticed for samples 4 and 5 and for samples 6 ÷ 8. The results for sample 2 and 9 are out of this trend since the waste used is non-homogenous. The percentage of constituents can vary and will lead to a composite material with mechanical properties influenced by fiberglass (the reinforcement) and ABS, PMMA (the matrix) quantities and disposal. Nevertheless, it can be observed that samples 3 and 8 possess the highest tensile resistance due to the maximum temperature used in the process (150°C).

These results indicate a better tensile behavior of the mixed waste being studied in comparison with LDF due to various fac-

tors, such as the density of the matrix, reinforcement disposal and density, nature of the constituents in the composite. Both studied materials are of the same type – short unoriented fiber composites. Even with a non-homogenous waste mix, the tensile behavior of waste-based material is better than LDF.

### 3.1.2. Results for flexural test

The flexural test was achieved to determine the flexural behavior of the GFRP plates compared to LDF plates. As shown in Fig. 6, the samples results were arranged in the chart from left to right following a constant pressure parameter, while temperature is increasing.

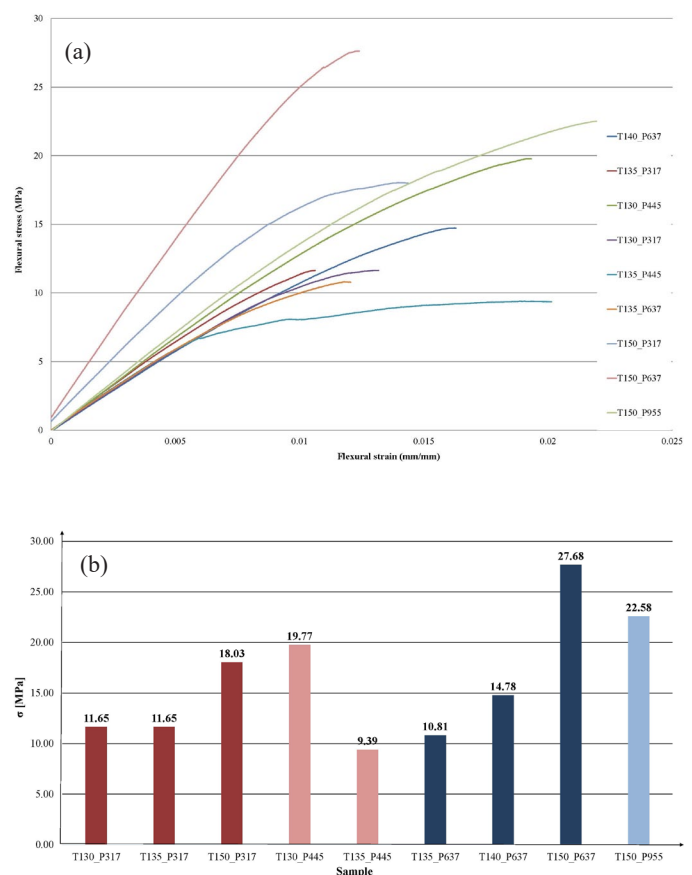

Fig. 6. Flexural test. a) Stress-strain diagram; b) Fracture flexural stress

We notice in samples 1 ÷ 3 that a slight change in temperature (5°C) will not influence the flexural behavior, but when the temperature rises to 20°C the mechanical behavior improves considerably. Also, the same temperature-related behavior can be observed for samples 6 ÷ 8. Samples 4 ÷ 9 manifest other behavior since the waste used is non-homogenous as we shown in the previous analysis of the tensile test. Samples 8 and 9 manifest the highest flexural resistance due to the temperature parameter (150°C).



### 3.1.3. Results for compression test

The results of compression test are showed in Fig. 7 where the samples results were arranged in the chart from left to right, marked with the same color when pressure is constant, and temperature is increasing. For the first group (samples 1 ÷ 3) it can be concluded that temperature induces a higher resistance to compression. The same phenomenon can be observed for samples 6 ÷ 7. The explanation for the other samples, which cannot prove this temperature-induced behavior, is a lack of homogeneity in the waste.

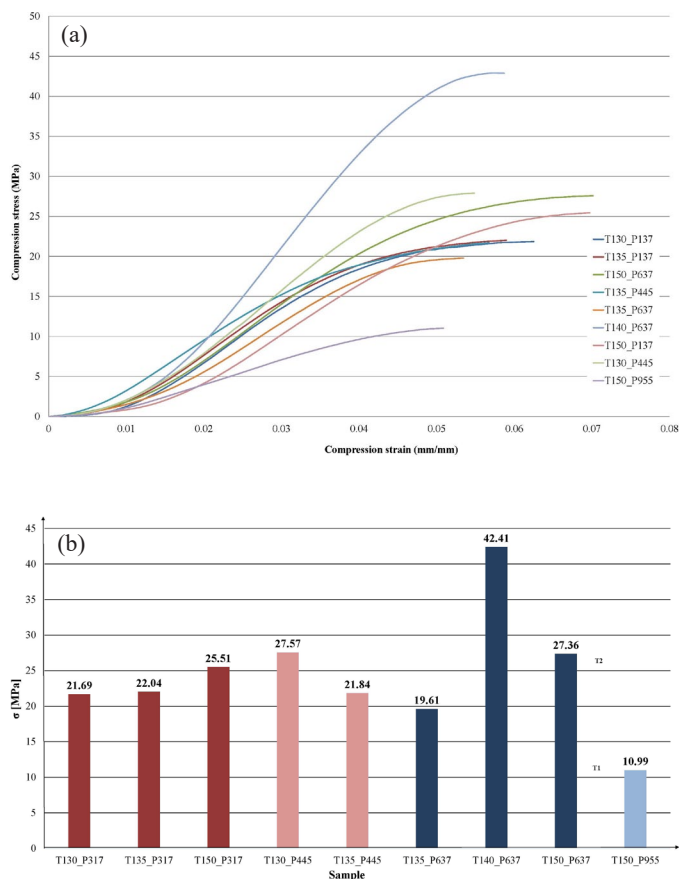

Fig. 7. Compression test. a) Stress-strain diagram; b) Fracture compression stress

The same behavior was observed for tensile and flexural tests and the explanations are similar, but what differentiates the material in this case is a superior compression strength 24.08 MPa (waste sample) versus 8.69 MPa (LDF), the two average values being compared. This property makes the obtained material a better suitable replacer for LDF, from a mechanical perspective.

### 3.2. Surface morphology

The surface morphological analysis of plates obtained from recycled mixed waste and LDF plates reveals the constituents of each plate. Depending on their nature (fiberglass,

plastic materials, or wood chips), dimensions and arrangement, each component influence the mechanical behavior of the final material. For the material thermoformed from the waste, the matrix is given by the polymeric flakes (ABS, PMMA) and the reinforcement by the fiberglass (Fig. 8a). For LDF, the matrix is given by the formaldehyde resin and the reinforcement by the wood chips (Fig. 8b).

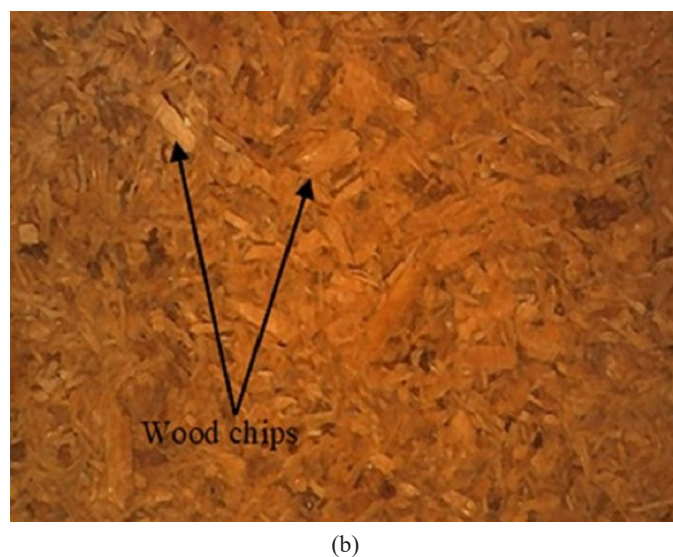
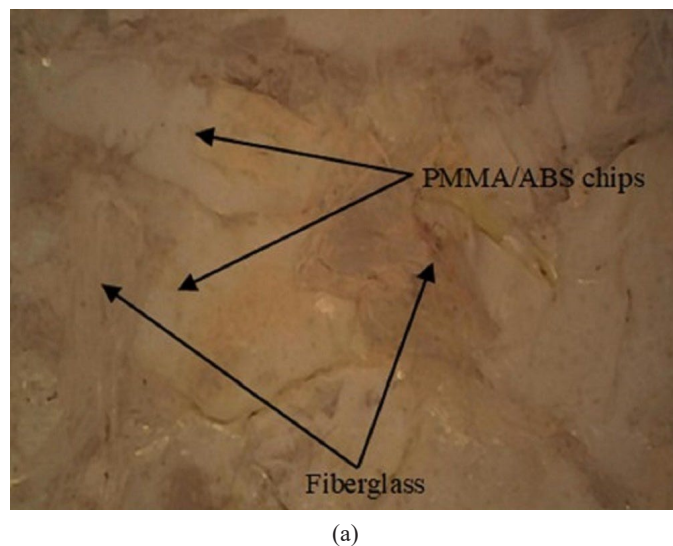

Fig. 8. Surface morphology: (a) Mixed waste; (b) Wood fiber plate (LDF)

## 4. Conclusions

The studied waste manifests outstanding features to be thermoformed due to its constituents – ABS, PMMA – thermo-plastic polymers. As a process parameter, temperature influences mechanical behavior. ABS properties are strongly related to processing and are especially dependent on the dispersal, size, and shape of the elastomers [37-41]. Moreover, the GFRP behavioral properties are strongly related to temperature, and static or low-velocity loads [42-47].

The newly studied composite material possesses the proper mechanical characteristics to successfully replace the LDF. Further studies will approach other characteristics: hydro absorption and adsorption, porosity, UV behavior – necessary because LDF is a wood composite designed and optimized to be used in various environments – with different percentage of moisture [48] and a replacer should manifest the same properties or even higher ones.

The novelty of the work consists, in addition to the mechanical characterization of the plates obtained from mixed waste, in determining an ecologically and economically efficient way to convert the process waste into a usable product.

#### Acknowledgments

The authors thank the following projects: “Entrepreneurial skills and research excellence in doctoral and postdoctoral study programs” – ANTREDOC (POCU/380/6/13/123927 CODE SMIS 123927); ExNanoMaT- “Supporting excellence in research in the field of nanotechnologies and advanced materials” and the Research Contract No. 19249/05.08.2020 “Ecological method for recyclable wastes valorization” – ECOWASTE.

#### REFERENCES

- [1] Y.C. Feng, F. Zhao, H. Xu, MATEC Web of Conferences (2016).
- [2] V. Vladimirov, I. Bica, International symposium “The environment and the industry” (2017).
- [3] S.N. Kasa, M.F. Omar, M.M.A. Abdullah, I.N. Ismail, S.S. Ting, S.C. Vac, P. Vazureanu, Mater. Plast. **54**, 91-97 (2017).
- [4] H. Jaya, M.F. Omar, H.M. Akil, Z.A. Ahmad, N.N. Zulkepli, M.M.A. Abdullah, I.G. Sandu, P. Vazureanu, Mater. Plast. **53**, 85-90 (2016).
- [5] A.M. Izzat, A.M.M. Al Bakri, H. Kamarudin, L.M. Moga, G.C.M. Ruzaidi, M.T.M. Faheem, A.V. Sandu, Mater. Plast. **50**, 171-174 (2013).
- [6] M.A. Faris, M.M.A. Abdullah, A.V. Sandu, K.N. Ismail, L.M. Moga, O. Neculai, R. Muniandy, Mater. Plast. **54**, 145-154 (2017).
- [7] W.M.W. Ibrahim, M.M.A. Abdullah, A.V. Sandu, K. Hussin, I.G. Sandu, K.N. Ismail, A.A. Radir, M. Binhussain, Rev. Chim. **65**, 1340-1345 (2014).
- [8] G.E. Popita, C. Rosu, D. Manciu, O. Corbu, A. Popovici, O. Nemes, A.V. Sandu, M. Proorocu, S.B. Dan, Mater. Plast. **53**, 308-311 (2016).
- [9] J.R. Correia, N.M. Almeida, J. R. Figueira, J. of Cle. Prod. **19**, 1745-1753 (2011).
- [10] F. Tittarelli, S.P. Shah, Constr. and Build. Mater. **47**, 1532-1538 (2013).
- [11] F. Tittarelli, Constr. and Build. Mater. **47**, 1539-1543 (2013).
- [12] P. Asokan, M. Osmani, A.D.F. Price, J. of Cle. Prod. **17**, 821-829 (2009).
- [13] A. Yazdanbakhsh, L.C. Bank, Y. Tian, Recycling **3** (1), 8 (2018).
- [14] S. Feih, E. Boiocchi, G. Mathys, Z. Mathys, A.G. Gibson, A.P. Mouritz, Compos.: Part B. **42**, 350-358 (2011).
- [15] S. Job, G. Leeke, P. Tarisai Mativenga, P. Pickering, N.A. Shuaib, Composites Recycling: Where are we now?, Composites UK (2016).
- [16] M.C. Santos Ribeiro, A. Fiuza, A. Ferreira, M. Lurdes Dinis, A.C.M. Castro, J.P. Meixedo, M.R. Alvim, Recycling **1**, 178-193 (2016).
- [17] J.P. Jensen, K. Skelton, Renew. and Sust. Ene. Rev. **97**, 165-176 (2018).
- [18] S. Job, Composite materials and end of life, Knowledge Transfer Network (2014).
- [19] E. Gutierrez, F. Bono, Review of industrial manufacturing capacity for fiber-reinforced polymers as prospective structural components in Shipping Containers, Publications Office of the European Union (2013).
- [20] Y. Aono, S. Murae, T. Kuboa, Pro. Eng. **10**, 2080-2085 (2011).
- [21] X.F. Nie, B. Fu, J.G. Teng, L.C. Bank, Y. Tian, Adv. in Eng. Mat., Str. and Sys.: Inno., Mec. and App. (2009).
- [22] A strategy for competitive, sustainable, and secure energy, Publications Office of the European Union (2010).
- [23] Directive 2000/53/EC of the European parliament and of the council on end-of life vehicles, Official Journal of the European Union (2000).
- [24] J. Palmer, O.R. Ghita, L. Savage, K.E. Evans, Comp.: Part A **40**, 490-498 (2009).
- [25] O. Hollins, P. Lee, E. Sims, O. Bertham, H. Symington, N. Bell, L. Pfaltzgraff, P. Sjögren. Towards a circular economy – Waste management in the EU, Science and Technology Options Assessment (2017).
- [26] K. Hamad, M. Kassem, F. Deri, Pol. Deg. and Sta. **98**, 2801-2812 (2013).
- [27] A.E. Tiuc, O. Vasile, H. Vermesan, M.A. Platon, Mat. Plas. **55**, 419-422 (2018).
- [28] M.A. Platon, M. Stef, A. Popa, A.E. Tiuc, O. Nemes, IOP Conference Series: Materials Science and Engineering (2018).
- [29] A.E. Tiuc, O. Nemes, H. Vermesan, A.C. Toma, Comp. Part B **165**, 120-130 (2019).
- [30] A. Borlea (Tiuc), T. Rusu, S. Ionescu, O. Nemes, Rom. Jou. of Mat. **42**, 405-414 (2012).
- [31] S. I. Borlea (Muresan), A.E. Tiuc, O. Nemes, H. Vermesan, O. Vasile. Materials **13**, 694 (2020).
- [32] A.M. Gombos, O. Nemes, V.F. Soporan, A. Vescan, Stud. Babes-Bol. Che. **81**, LIII (2008).
- [33] M.A. Platon, O. Nemes, A.E. Tiuc, O. Vasile, S. Paduretu, Phono absorbent behavior of new fiberglass plates from mixed plastic material wastes, in Lucas F. M. da Silva (Ed.), Materials Design and Applications III, Springer (2020).
- [34] ASTM D7264 / D7264M-15, Standard Test Method for Flexural Properties of Polymer Matrix Composite Materials, ASTM International, West Conshohocken, PA, 2015, www.astm.org.
- [35] ASTM D3039 / D3039M-17, Standard Test Method for Tensile Properties of Polymer Matrix Composite Materials, ASTM International, West Conshohocken, PA, 2017, www.astm.org.
- [36] ASTM D3410 / D3410M-16, Standard Test Method for Compressive Properties of Polymer Matrix Composite Materials with Un-

- supported Gage Section by Shear Loading, ASTM International, West Conshohocken, PA, 2016, [www.astm.org](http://www.astm.org).
- [37] A. Casale, O. Salvatore, G. Pizzigoni, *Pol. Eng. and Sci.* **15**, 286-293 (1975).
- [38] E. Scalco, T.W. Huseby, J.R. Blyler, *Jou. of App. Pol. Sci.* **12**, 1343-1353 (1968).
- [39] B.E. Tiganis, L.S. Burn, P. Davis, A. J. Hill, *Pol. Deg. and Stab.* **76**, 425-434 (2002).
- [40] M. Dawoud, I. Taha, S.J. Ebeid, *Jou. of Manuf. Proc.* **21**, 39-45 (2016).
- [41] C.R. Bernal, P.M. Frontini, R. Herrera. *Pol. Test.* **11**, 271-288 (1992).
- [42] M. Rahman, N.R. Schott, L.K. Sadhu, *Proceedings of the COM-SOL Conference* (2016).
- [43] R.W. Truss, G.A. Chadwick, *Jou. of Mat. Sci.* **11**, 111-117 (1976).
- [44] D. Garcia-Gonzales, A. Rusinek, A. Bendarma, R. Bernier, S. Klosak, S. Bahi, *Pol. Test* **81**, 106263 (2020).
- [45] S. Zangana, J. Epaarachchi, W. Ferdous, J.S. Leng, *Int. J. Impact Eng.* **137**, 103430, (2020).
- [46] W. Ferdous, T.D. Ngo, K.T.Q. Nguyen, A. Ghazlan, P. Mendis, A. Manalo, *Comp. Part B* **155**, 414-424 (2018).
- [47] M. Nasraoui, P. Forquin, L. Siad, A. Rusinek, E. Dossou, *Dym. Int. Conf.* **2**, 1103-1108, (2009).
- [48] K. Lengyel, PhD thesis, Contributions to the manufacturing technology of wooden particleboards (PB) with a view to improving some of their properties, Transilvania University, Brasov, (2019).