



Juliya MALOGULKO¹, Vira TEPTIA², Natalia OSTRAS³, Olena SIKORSKA⁴, Kateryna POVSTIANKO⁵

Tools for modeling the level of harmonic distortion in power grids and their impact

ABSTRACT: The impact of harmonic distortions on power grids is a major issue in contemporary power networks as a result of the extensive application of non-linear loads. The purpose of this article is to explore the problem of harmonic distortion in power grids and its impact on the elements of the power grid, such as cable lines and transformers. The Schaffner PQS software product was used in this study to model power grids. New techniques for modeling power grids and finding technical solutions that meet the IEEE 519-2014 standard were introduced. The study finds that harmonic distortion can lead to an additional heat load being placed on cable lines and reduces the power available to transformers, which can decrease their rated power. The application of modern software reduces the time and complexity of calculations, and the availability of software solutions for limiting harmonic distortion simplifies the creation of solutions that meet this standard. Using the methods

✉ Corresponding Author: Juliya Malogulko; e-mail: juliya.malogulko@ukr.net

¹ Vinnytsia National Technical University, Ukraine; ORCID iD: 0000-0002-6637-7391; e-mail: juliya.malogulko@ukr.net

² Vinnytsia National Technical University, Ukraine; ORCID iD: 0000-0002-2792-0160; e-mail: teptia.vi@gmail.com

³ Vinnytsia National Technical University, Ukraine; ORCID iD: 0000-0002-8245-2937; e-mail: ostra_n@yahoo.com

⁴ Vinnytsia National Technical University, Ukraine; ORCID iD: 0000-0001-7341-9724; e-mail: sikorska.o@ukr.net

⁵ Vinnytsia National Technical University, Ukraine; ORCID iD: 0000-0002-5501-662X; e-mail: ka_povstianko@aol.com



© 2023. The Author(s). This is an open-access article distributed under the terms of the Creative Commons Attribution-ShareAlike International License (CC BY-SA 4.0, <http://creativecommons.org/licenses/by-sa/4.0/>), which permits use, distribution, and reproduction in any medium, provided that the Article is properly cited.

presented in the study, engineering solutions can be improved, the reliability of electrical systems can be increased, and the loss of electrical energy can be reduced. This can enhance efficiency for design engineers and technical specialists involved in the operation of power grids.

KEYWORDS: energy quality, harmonics, harmonic calculation, energy saving technologies, nonlinear consumers

Introduction

The growing number of accidents in power grids caused by non-linear consumers has become a serious concern in modern power networks. Non-linear consumers refer to electrical loads that do not have a linear relationship between the applied voltage and the resulting current, including computers, televisions, and other electronic equipment that use power supplies based on switching technology (Manoj et al. 2022; Bondarenko et al. 2018). Such loads cause harmonic distortions in the electrical system, leading to various problems such as waveform distortion, the overheating of electrical equipment, interference with sensitive electronic equipment, and even equipment malfunction or failure, which can constitute safety hazards and cause emergencies (Kharlamov et al. 2015; Korzhyk et al. 2017). In addition, non-linear consumers can increase the level of reactive power in the electrical system, which can lead to a reduction in power factor and increased energy costs.

Although much theoretical research has been conducted on this topic, such as the work of Fuch and Masoum (2008), these studies are not relevant to the present situation due to their narrow focus on a particular industry sector. However, with the widespread use of non-linear load types, such studies have gained new importance (Atamanyuk et al. 2019; Bhavani et al. 2022). The latest energy-saving technologies in industrial enterprises that use variable frequency drives, in addition to the positive effect of energy storage, negatively affect the state of the power grid (Bondarenko and Gorbenko 2018; Niyazbekova et al. 2022). Aside from this, all the positive effects will be offset by a decrease in the service life and premature failure of the equipment (Batrakov et al. 2017; Fialko et al. 1994).

World leaders in the electrical market, such as Schneider electric – one of the largest suppliers of frequency converters – offer consumers a complete solution that reduces the impact of harmonic distortion in the network to the level defined by the IEEE 519-2014 standard (2014), which was specifically created for this purpose. The main modern criterion that regulates the requirements for power grids regarding the permissible level of harmonic distortion is compliance with the IEEE 519-2014 standard. A set of solutions offered by Schneider electric to reduce the level of harmonic distortion can be found in the paper (Harmonic mitigation 2009). Special attention should be paid to the Swiss company, Schaffner Group, which specializes in the production of a huge range of equipment necessary to reduce the level of harmonic distortion. Firstly, this company is a supplier of equipment for world industry leaders, and secondly,

it has extensive practical experience in this specialized industry. Useful information on current standards and problems that cause harmonic distortions in power grids can be obtained in the literature (Kamenka 2014).

One of the main obstacles to the distribution of solutions for limiting harmonic distortion was the lack of software products available to a wide range of specialists that would substantially simplify and speed up the production of appropriate calculations and technical solutions. However, due to the rapid development of information technologies, Schaffner has created a software product – Schaffner PQS (Power Quality Simulation) (2016) – for modelling the level of harmonic distortion of the power network, which enables the selection of technical solutions and checking compliance with the IEEE 519-2014 standard.

The main goal of this study is to introduce Schaffner PQS and perform simulations to analyze the impact of non-linear consumers on conventional power grids in the scenario in which solutions to reduce harmonic distortion are not implemented. Additionally, the study provides coefficients for increasing the size of the cross section of conductors with consideration to the harmonic distortions in the network and data on the influence of reactive power compensation devices on the level of harmonic distortion in the power grid. The study also presents individual technical solutions of Schaffner, including passive harmonic filters (2020), which were used in the analysis.

1. Materials and methods

The main method used in this study is the modelling of power grids using the Schaffner PQS software product of the Schaffner company. This software is a web-based simulator of electricity quality in power grids. It is necessary to download one of the following minimum versions of the tested browsers in order to be able to use the program: Internet Explorer (version 10), Firefox (version 46), Chrome (version 49), Opera (version 37), Safari (version 9). Every new computer should be able to work with these browsers, and most already have one of these versions installed. However, before downloading and installing, it is always a good idea to check the minimum system requirements to make sure that the selected browser will work smoothly on the computer. As a web application, the Schaffner PQS software is highly dependent on internet technologies and uses one of the default browsers installed on the system. Therefore, an appropriate internet connection is required to use Schaffner PQS. The use of a broadband internet connection is recommended. However, the Schaffner PQS will also work on low-speed internet connections.

The study has three main stages. In the first stage, general information regarding the power grid which needs to be modelled is collected. This information includes: frequency, primary and secondary voltage, power, transformer short circuit coefficient, cross section, and cable line length; the number, power, and type of each load; length and cross section of cable lines for connecting the load; load factor for each consumer; availability, power, and type of reactive power

compensation device. In the second stage, a simplified electrical diagram of the corresponding power grid is modelled using the graphical interface, and the collected information is entered into its corresponding elements. After that, the project is saved and the system is calculated.

In the third stage, calculations are analyzed for compliance with the level of harmonic distortion corresponding to the standard. In this study, in particular, the [IEEE 519-2014 standard \(2014\)](#) applies. If the harmonic distortion level exceeds the established standards, it is necessary to add appropriate elements to reduce the harmonic distortion level from a Schaffner products line. These components include: active harmonic filters, passive harmonic filters, input throttles for frequency drives and 18-pulse smoothing filters. By trial and error, a technical solution that meets the relevant standard is identified. Admittedly, there are general recommendations for using certain elements and developing an optimal solution from the technical and financial side. For example, it is recommended to use the input throttle of a frequency converter in most cases. Restrictions can only be imposed if the line length is long. Notably, the throttle additionally reduces the voltage at the input of the converter. When installing a reactive power compensation device, it is necessary to add protective throttles for capacitors. It is recommended to examine the best practices of well-known specialists in order to get relevant experience in using certain elements.

After receiving a technical solution that meets the [IEEE 519-2014 standard \(2014\)](#), the program allows the production of a complete report, in which the calculated data of the simulated power grid is provided in graphical and tabular form. The graphic form greatly facilitates the perception of information and allows making the report more complete and simplified for analysis.

2. Results and discussion

2.1. Power factor under harmonic distortion conditions

It is proposed to consider a practical task that a wide range of specialists now face, specifically power grid designers and operating engineers. The technical solutions performed using outdated methods (disregarding the impact of nonlinear loads) and modern methods (Schaffner PQS program) are analyzed and compared with current international standards, such as [IEEE 519-2014 standard \(2014\)](#). Firstly, a very important indicator that characterizes the load at alternating current is considered, namely the power factor (PF) in the context of the active power ratio (P) of the consumer to the full (S):

$$PF = P/S \tag{1}$$

In systems where there are no non-linear consumers, the total power is determined only by an active and reactive (Q) composite:

$$S = \sqrt{P^2 + Q^2} \quad (2)$$

In this case, the power factor is equal to $\cos\varphi$ or DPF (displacement power factor):

$$\cos\varphi = P / S = DPF \quad (3)$$

Graphically, this looks like a shift in the voltage and current curves. It is very important to note that the shapes of the voltage and current curves are undistorted (pure) sinusoids (Fig. 1).

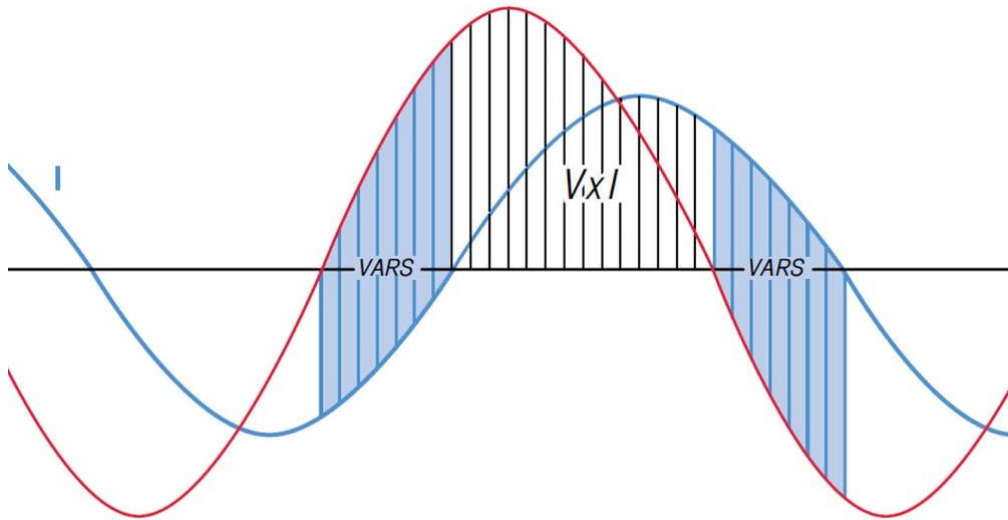

Fig. 1. $\cos\varphi$ or DPF

Rys. 1. $\cos\varphi$ lub DPF

The presence of harmonic distortion leads to the appearance of another component of power D , which further increases the full power:

$$Spq = \sqrt{P^2 + Q^2 + D^2} \quad (4)$$

Figure 2 graphically displays these ratios and simplifies perception to increase the information content.

In addition to the above, a graph obtained from real measurements of a nonlinear load (a frequency converter (FC)) is offered. The levels of a sinusoid of current and even voltage distortion are presented in this graph. These are the existing signs of the presence of harmonic distortions in the power grid, and in such cases, it is necessary to consider the third component of total power, power D (Fig. 3).

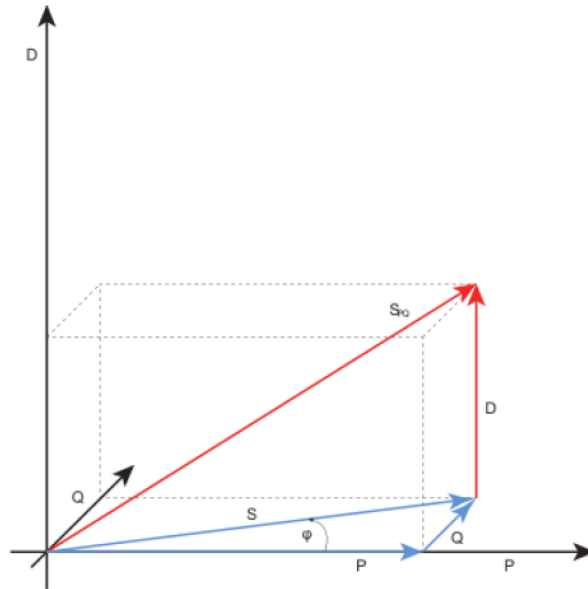

Fig. 2. Power in the presence of harmonic distortion

Rys. 2. Moc w obecności zniekształceń harmoniczných

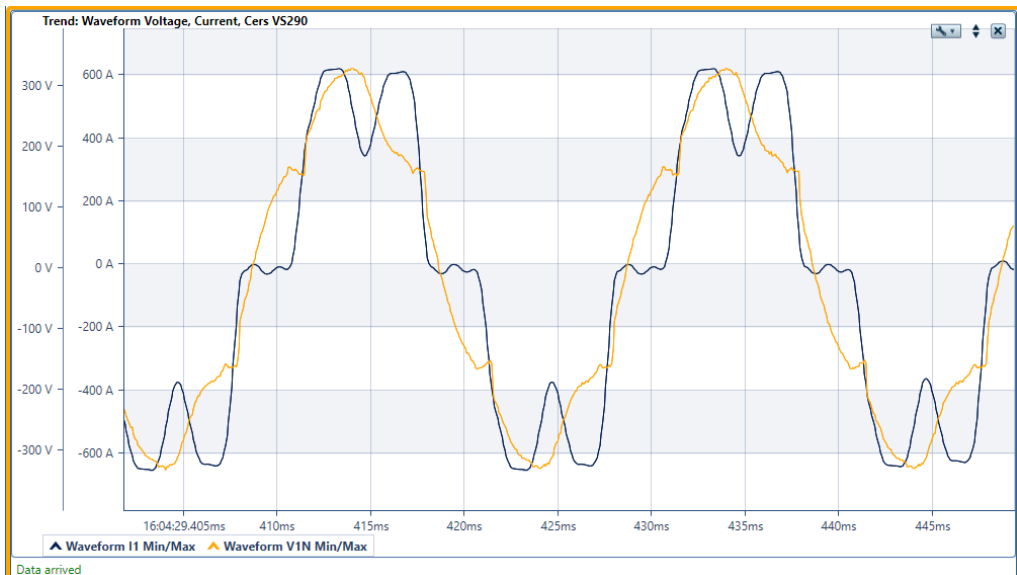

Fig. 3. Shape of voltage and current curves under conditions of substantial harmonic distortion

Rys. 3. Kształt krzywych napięć i prądów w warunkach znacznych odkształceń harmoniczných

More extensive and analytical information and methods for determining the power factor in accordance with the IEEE Standard 1459-2010 can be obtained in the literature (Malengret and Gaunt 2020). According to the information received regarding the concept of the power factor, it is necessary to accurately understand the difference between the cosine phi and the power factor. Their values only match when there is no distortion of the current and voltage curves in the network. If the distortion of the sinusoids is present, it is necessary to operate with the concept of power factor. Unfortunately, a very large proportion of specialists do not realize this difference and receive incorrect calculations as a result, thus increasing the likelihood of using the wrong technical solution, which can lead to a reduction in the service life of the equipment, its premature failure, and in general, the impossibility of the correct operation of the entire system.

There is another important nuance that is very often not considered when determining DPF or $\cos\phi$. Depending on the characteristics of the inductive or capacitive load, the sign of this parameter should change; for inductive loads, it has a positive value, and for capacitive loads, it has a negative value. For a motor, for example, $\cos\phi = 0.8$, and for an LED (Light-Emitting Diode) floodlight $\cos\phi = -0.9$. When calculating the reactive power balance, this should be considered, and negative reactive power values for the capacitive load should be included in the calculation of the total reactive power of the system. In practice, some manufacturers of electrical equipment add the following designations: *lag* or *lead* for the load type mark, and the sign $\cos\phi$. They also sometimes add an index *cap* or *ind*, denoting capacitive and inductive $\cos\phi$. Figure 4 shows typical graphs for different types of loads.

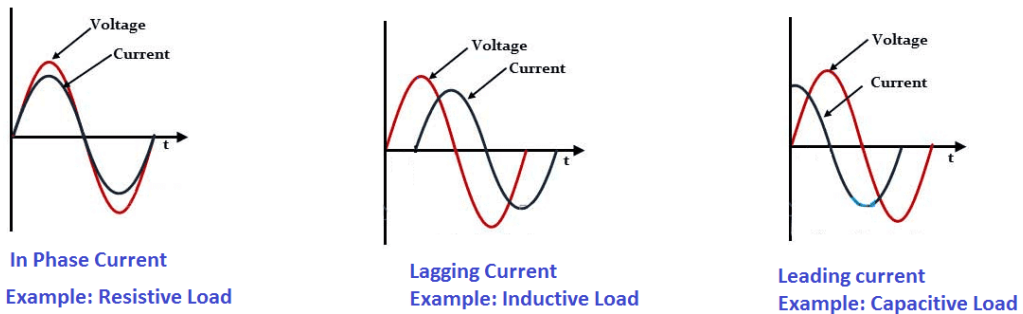

Fig. 4. Voltage and current graphs for resistive, inductive, and capacitive loads

Rys. 4. Wykresy napięć i prądów dla obciążeń rezystancyjnych, indukcyjnych i pojemnościowych

Fifteen to twenty years ago, inductive consumers prevailed in the power grid but recently this situation has changed to the opposite. The graphs in Figure 5 show the results of real measurements taken on the power line of a set of controlled LED floodlights.

There is a fairly high generation (negative values) of reactive power. In fact, the trend of increasing reactive power generation is becoming increasingly relevant for modern power grids, for example, in a very large proportion of offices and shops, the capacitive load produced by lighting, computers, and other equipment with switching power supplies prevails. In such cases,

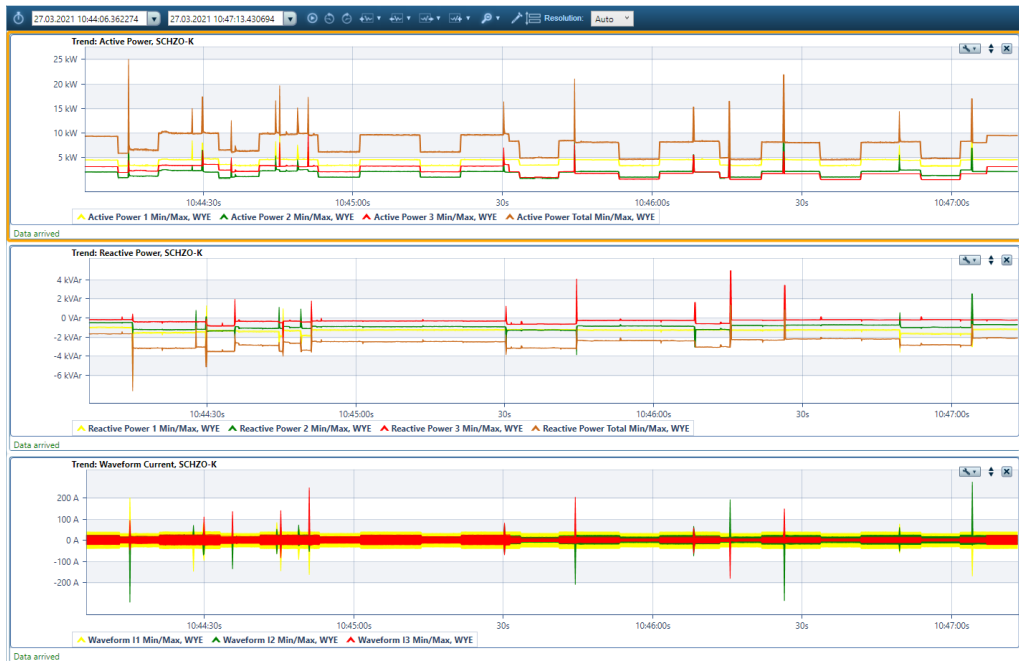

Fig. 5. Graphs of measurement of active, reactive power, and current waveform on the LED floodlight power line

Rys. 5. Wykresy przebiegu pomiarów mocy czynnej, biernej i prądu na linii zasilającej naświetlacz LED

other solutions are used to correct the power factor instead of the usual capacitor systems. Figure 6 shows the measurement data on the power supply line of the office space.

Figure 6 displays that even turning on the compressors of air conditioners does not transfer the reactive power balance to being inductive and it remains capacitive, and on average, DPF is equal to 0.92 *cap*.

2.2. Power grid modelling using Schaffner PQS

The third component of total power-harmonic distortion is considered in more detail. In fact, this concept adds another dimension by converting all the calculations into 3D. A simulation of the power grid with the main factor in the occurrence of the 3rd dimension in the modern power grid is created; this is the variable speed drive frequency converter (VSD). A huge number of manufacturers offer this equipment and promise substantial savings in electrical energy when used in some applications. The study attempts to identify what is needed in order to get energy savings when installing an FC without reducing the service life of other elements of the power grid. What are the methods for reducing harmonic distortion and how do they



Fig. 6. Graphs of measurement of reactive, active power, and the power factor on the office power line

Rys. 6. Wykresy pomiarów mocy biernej, czynnej i współczynnika mocy na biurowej linii elektroenergetycznej

impact the power grid? The power grid in which a 290 kW compressor with a frequency drive is installed is simulated. The Schaffner PQS program is used to perform calculations. Instruction on access to this program and the requirements for the technical component are given in the previous sections.

A typical industrial network is considered, it has a frequency of 50 Hz, a medium voltage transformer with an output of 10 kV, a power of 20 MW, $U_{sc} = 5\%$ that supplies a line made of aluminum with a cross section of 120 mm^2 , a length of 800 m, a 10/0.4 kV transformer, a power of 1000 kW with $U_{sc} = 6\%$. The transformer supplies power to a 290 kW FC compressor with a line length of 370 mm^2 made of 30 m of copper, a motor control cabinet with a power of 200 kW with a line length of 300 mm^2 made of 30 m of copper. It is necessary to make network calculations for compliance with the [IEEE 519-2014 standard \(2014\)](#) and select a power factor correction device that will provide a $DPF (\cos\phi)$ of not less than 0.98.

After registering a personal account in the Schaffner PQS program, a new project is created. Using the graphical interface of the program, a single-line diagram is formed according to the terms of reference. Following this, the characteristics of the elements are entered. When entering the VSD indicators, a 4% DC (direct current) throttle is additionally selected. Usually, powerful VSD devices are equipped with this option from the factory. However, in any case, it is necessary to check this information with the equipment supplier. In this example, the most typical sets of

equipment are considered. In the first scenario of the simulation, Figure 7 shows a circuit without a reactive power compensation device.

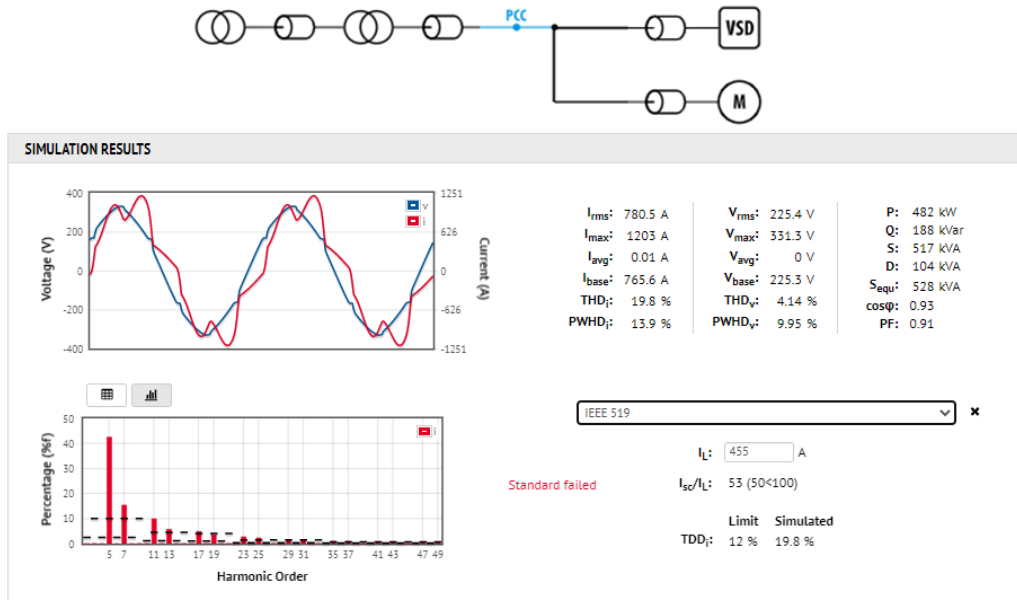

Fig. 7. Scenario 1 (without reactive power compensation device)

Rys. 7. Scenariusz 1 (bez urządzenia do kompensacji mocy biernej)

This is necessary in order to determine the reactive power value that the system requires. Please note that the parameters are calculated for the PCC (point of common coupling). It is indicated in blue on the diagram. According to the simulation results, the system parameters do not comply with the IEEE 519-2014 standard (2014). The THD_i (total demand distortion) values of the current are exceeded by 19.8% at the allowed 12%, the values of harmonics of the current are exceeded, too. In addition, the reactive power consumption is 188 kVar. In the second scenario, a reactive power compensation device is added (Fig. 8).

The common standard power of 200 kVar is chosen. As the dominant harmonic is the fifth, the frequency of the capacitor throttle is 189 Hz. This protects the capacitors and reduces the probability of resonant phenomena in the network (Key components for power... 2018). The following simulation results are obtained. The THD_i level decreased from 19.8% to 16.5% but still remains above normal; the levels of 5, 7 and other harmonics of current also decreased, but these were also above normal. The reactive power values are 19.2 kVar, but this value should be negative, based on the fact that 200 kVar of capacitive load, with the need for 188 kVar was added. This disadvantage of the program should be recognized. In any case, the installation of a compensation device reduced the level of harmonic distortion, reducing the current from 780A to 726A and thus reducing the load on the power transformer. The compensation device absorbs

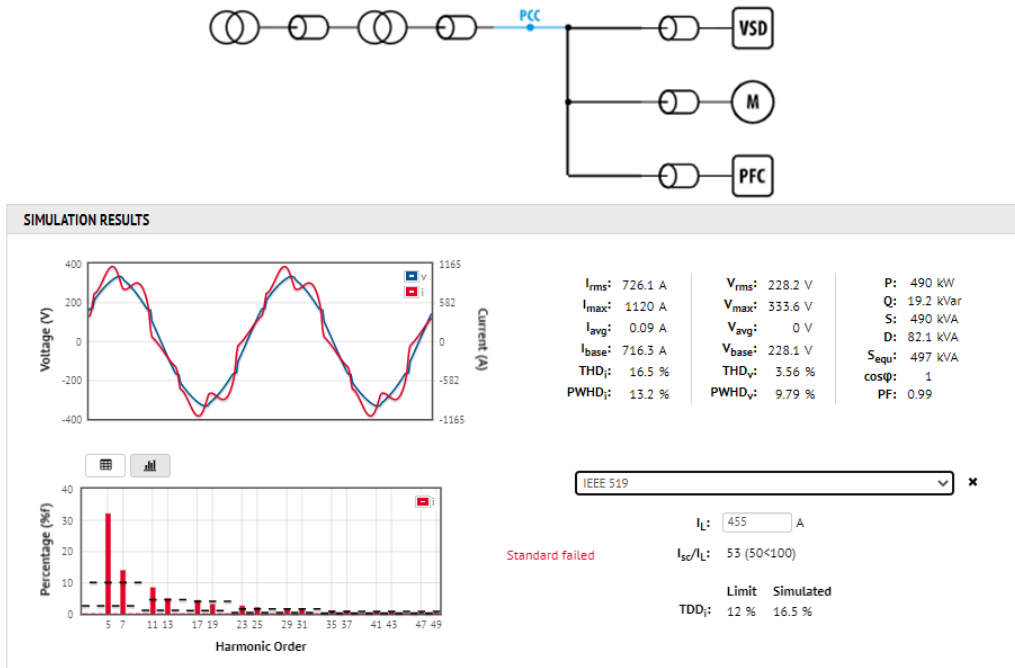

Fig. 8. Scenario 2 (with reactive power compensation device 200 kVar, 189 Hz)

Note: PFC – power factor correction

Rys. 8. Scenariusz 2 (z urządzeniem do kompensacji mocy biernej 200 kVar, 189 Hz)

Uwaga: PFC – korekcja współczynnika mocy

part of the current at the main frequency and its harmonic components from the system. However, this effect is observed only if the device parameters are correctly selected and throttles are used. In the third scenario, the reduction of harmonic distortion is affected by the installation of a linear throttle (Fig. 9).

A standard linear throttle RWK 212-500-s is added to the FC power line. After performing calculations, a TDD_i level of 13% is obtained, which is very close to the allowed limit of 12%. Harmonic levels have also decreased but are still above the limits set by the [IEEE 519-2014 standard \(2014\)](#). Therefore, the installation of a linear throttle, although it reduces the level of harmonics, does not guarantee their reduction to the required level. In Scenario 4, the manner in which the harmonic distortion reduction is affected by installing a passive filter instead of a linear throttle is considered (Fig. 10).

A passive filter FN3471-315-99 is installed. As a result, $TDD_i = 2.52$ at a norm of 12, and current harmonic levels with a margin within the normal range are obtained. Therefore, the power grid with these elements meets the norms of the [IEEE 519-2014 standard \(2014\)](#). In addition, the excess reactive power increased to 47 kVar, which compared to Scenario 2, differs by 28 kVar. This was influenced by the capacitive component of the passive filter, considering which, the

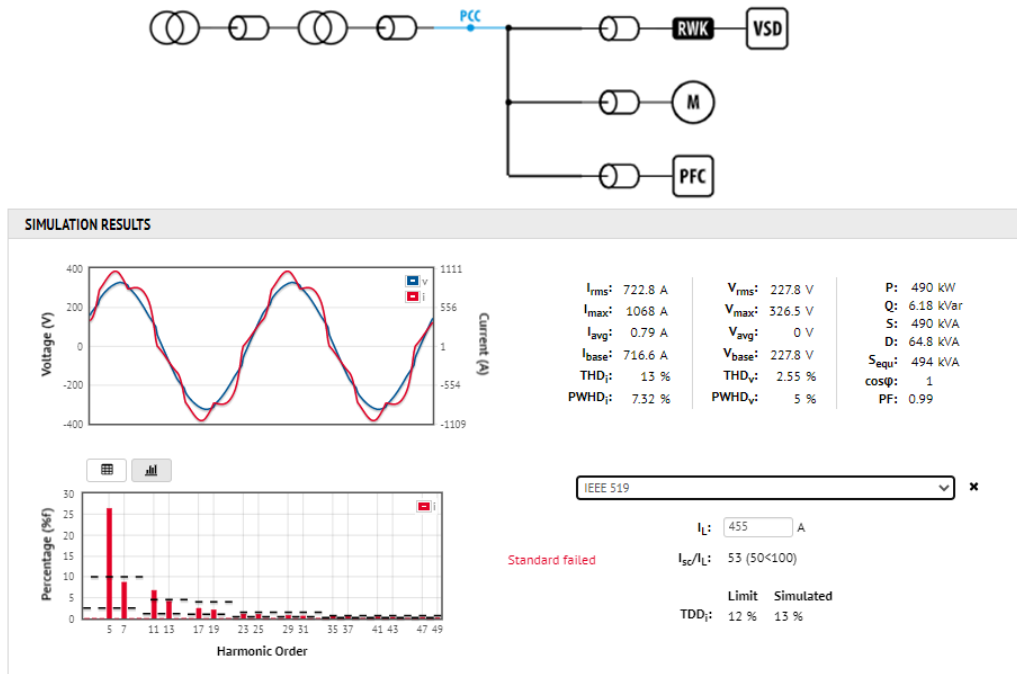

Fig. 9. Scenario 3 (with additional linear throttle)

Rys. 9. Scenariusz 3 (z dodatkowym dławikiem liniowym)

power of the reactive power compensation device can be reduced by 160 kVar. Thus, to meet the requirements of the IEEE 519-2014 standard, a passive filter had to be added to the solution. In addition to reducing the harmonics of the current, setting the PHF (passive harmonic filters) also resulted in a very substantial reduction in harmonic voltage distortion. Compared to Scenario 2, THD_v decreased from 3.56 to 0.86%. This has a very positive effect on all elements of the system by reducing losses and increasing the service life of the equipment. After the solution has become compliant with the standard, the program has the opportunity to make an extended report of these calculations, it reflects in great detail all the important nodes of the system, graphs, and calculation data.

2.3. The effect of harmonic distortion on cable lines

An assessment of the effect of harmonic distortions on elements of the power grid has also been performed (Electrical Installation Guide 2018). This helps to determine additional losses in the cable line depending on the level of harmonic current distortion THD_i (Fig. 11).

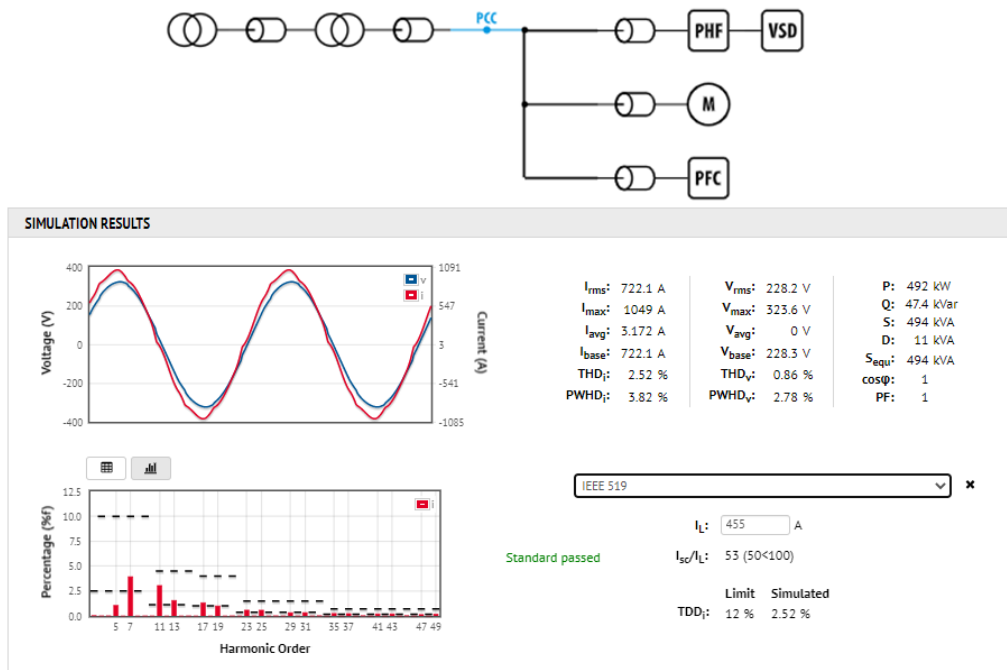

Fig. 10. Scenario 4 (with additional passive filter)

Rys. 10. Scenariusz 4 (z dodatkowym filtrem pasywnym)

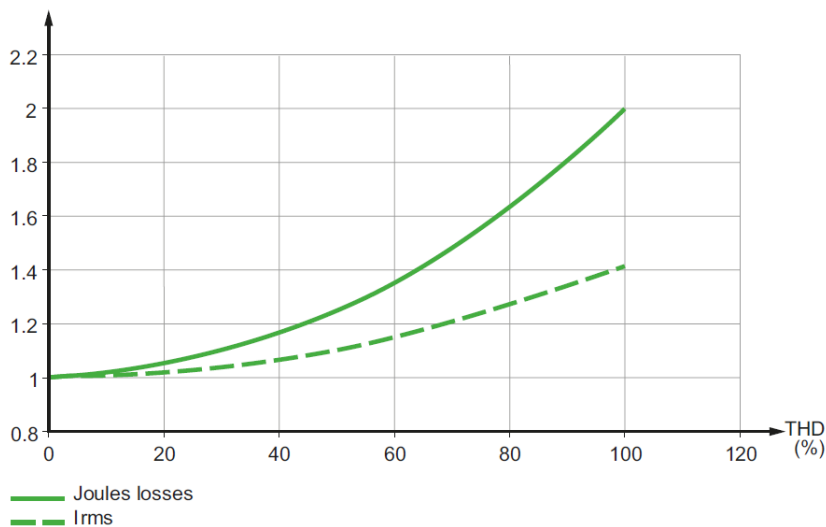

Fig. 11. Additional losses in the cable line depending on harmonic current distortion THD_i

Rys. 11. Dodatkowe straty w linii kablowej w zależności od odkształceń harmoniczných prądu THD_i

The effect of the installation of a passive filter in the FC power supply line on the additional heat load of the cable line has also been analyzed. With regard to the data of this study, in the FC power line without an additional filter $THD_i = 37\%$, additional losses are approximately 16%, i.e. this additional heat load must be considered when calculating the cable line. Figure 12 demonstrates how the current in the FC supply line has changed.

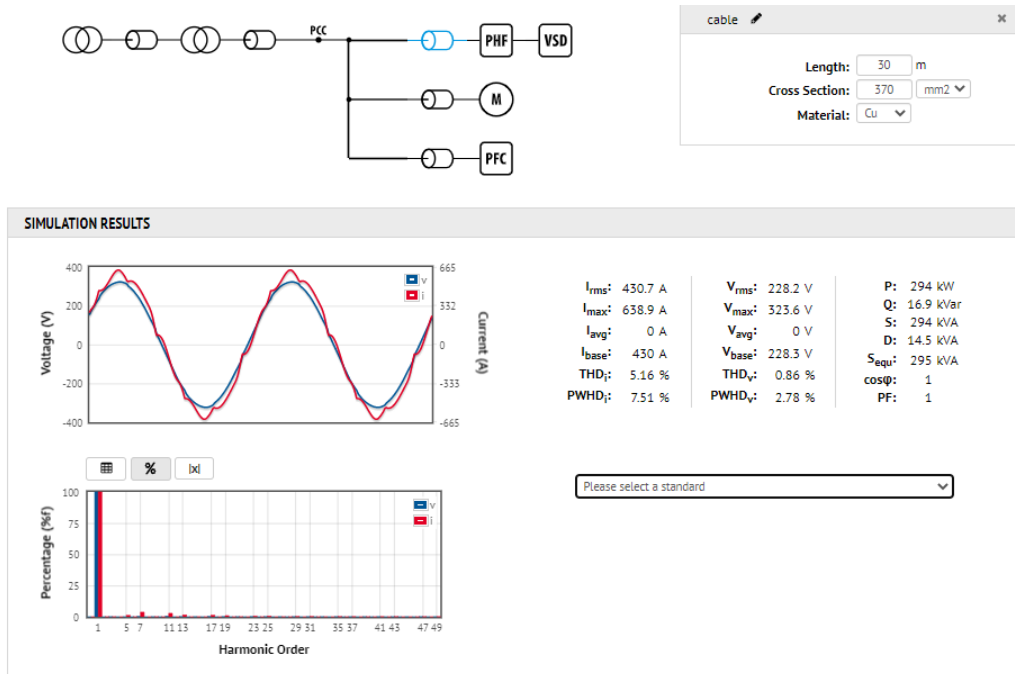

Fig. 12. FC power line with additional passive filter

Rys. 12. Linia zasilająca FC z dodatkowym filtrem pasywnym

The program enables obtaining this data by simply selecting the desired element. Therefore, after installing the passive filter, the current in the line is 430 A, and the coefficient of nonlinear current distortion is $THD_i = 5.16\%$. The current values in the FC line without filters are presented for comparison (Fig. 13).

The line current is 461 A, and the nonlinear distortion coefficient is $THD_i = 37\%$. Most evident is the comparison of current and voltage graphs, in which a substantial difference is observed. The sinusoid of the current on the line with filters is almost not distorted, and the sinusoid of the current on the line without a filter is very distorted. By numerical values, the current is 7% higher, and the THD_i is seven times higher. In other words, the FC cable line without filters has a greater load and the additional influence of the current of higher harmonics. This should be considered when calculating the cross-section of the cable line. With a sufficiently large cable length, installing a passive filter reduces the required line cross section and reduces the cost of

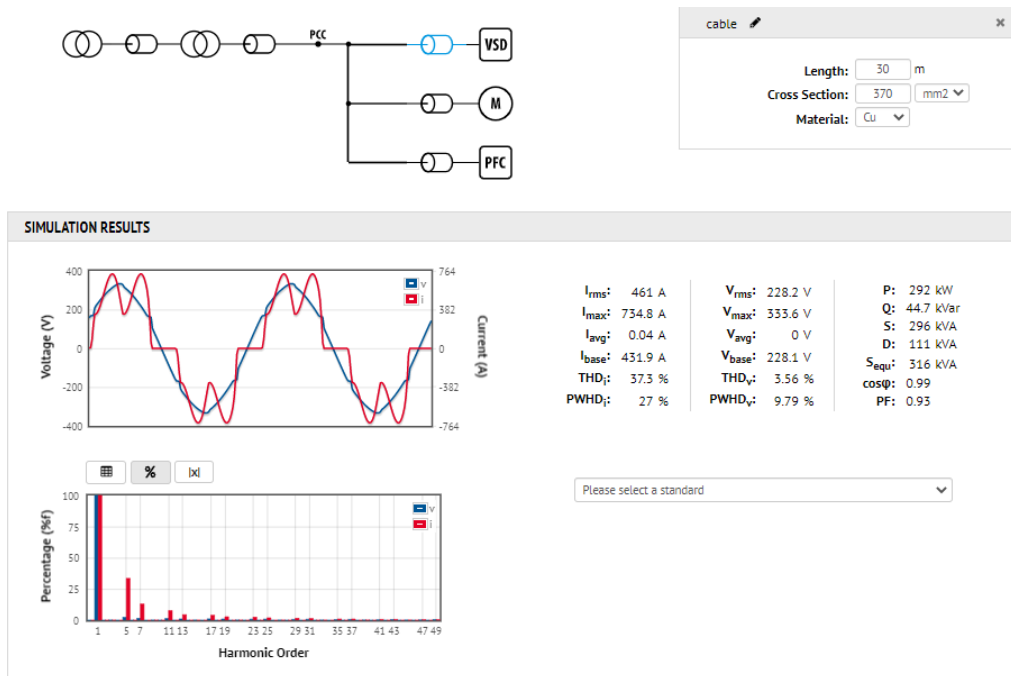

Fig. 13. FC power line without a filter

Rys. 13. Linia zasilająca FC bez filtra

the project. Thus, the cost of the filter is compensated by a decrease in the cost of the cable line, and the total cost of the solution does not increase. In addition, improving the quality of energy can substantially reduce energy losses, increase the service life of equipment, and substantially increase the efficiency of electrical equipment operation. These conclusions are supported by studies of other authors who also come to the conclusion that it is necessary to consider the influence of harmonic distortions on elements of power grids. It is necessary to introduce new, modern methods that can effectively simulate the level of harmonic distortion in electrical systems to assess the impact.

O'Connell et al. (2012) discuss the expediency of introducing an additional cable-deriving factor in accordance with the influence of harmonic loads in their paper. Sets of measurements made on a typical cable are analyzed. It is concluded that the direct use of the deriving factor adopted by the BS7671 standard is rather conservative and can lead to exceeding the size of linear conductors for three-phase circuits, but it is considered beneficial in the long run. The study by Duran-Tovar et al. (2013) presented a method for estimating the expected service life of a cable under the influence of harmonic distortion and an imbalance in low-voltage (LW) conductors. Available models for estimating the ageing rate of cable conductor insulation are presented. These studies also confirm the urgency of the problem of the effect of harmonic distortion on cable lines, which leads to their additional loading and reduced service life.

It can be said that harmonic distortions have a significant impact on the power factor of electrical systems. The power factor is affected by the phase relationship between the voltage and current in the system. In a system with harmonic distortions, the phase relationship between the voltage and current can be altered, leading to a reduction in the power factor. This is because the harmonic currents create reactive power that cannot be used effectively, resulting in a lower power factor. Therefore, it is important to characterise the influence of harmonic distortions on the power factor in order to ensure the efficient use of electrical power and reduce energy losses. This can be done by using devices such as active power filters and passive filters to reduce the level of harmonic distortion in the system and improve the power factor.

2.4. The effect of harmonic distortion on transformers

In addition to affecting cable lines, harmonic distortions can reduce the available power to the transformer which is used to power nonlinear loads. This additional thermal load is added to both the transformer windings and the magnetic circuit, leading to a decrease in the rated power of the transformer (Stavinskii et al. 2019). The decrease in the rated power of the transformer depending on the percentage of nonlinear consumers in the power grid is shown in Figure 14. This graph is presented in the UTE C15-112 standard (2000).

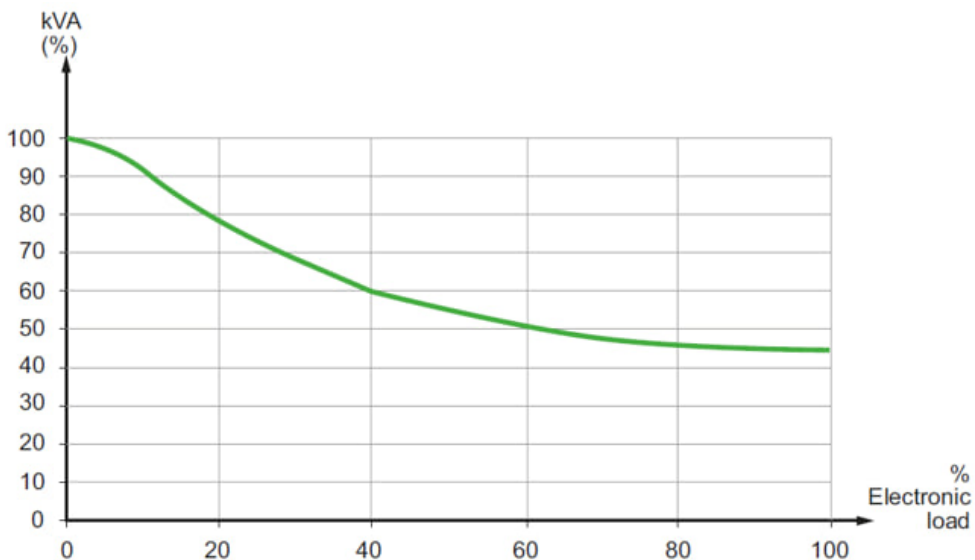

Fig. 14. Derating coefficient for transformers as a function of harmonic currents according to the UTE C15-112 standard

Rys. 14. Wyrowadzenie współczynnika dla transformatorów w funkcji prądów harmoniczných według normy UTE C15-112

Figure 15 presents a photograph of the transformer from a real thermographic survey of the object, in which constant overheating of the power transformer was observed as a result of harmonic currents.

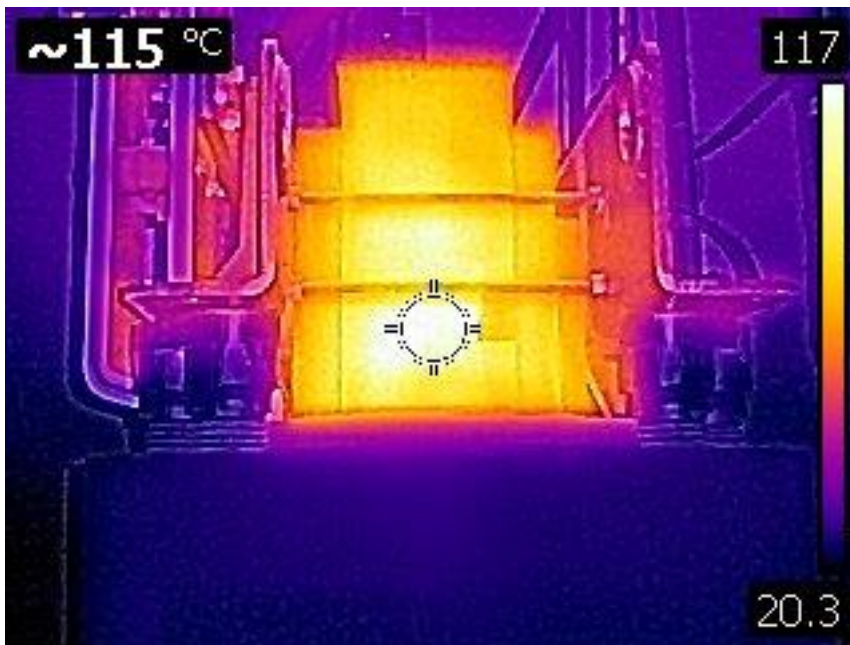

Fig. 15. Heating of the dry transformer magnetic circuit under the influence of harmonic distortion

Rys. 15. Nagrzewanie obwodu magnetycznego suchego transformatora pod wpływem zniekształceń harmoniczných

The transformer temperature reduction was achieved only after replacing existing reactive power compensation devices. Thermographic examination of a power transformer device can be used to see the consequences of not taking into account harmonic distortions when designing an electrical network. If there is harmonic distortion present in the network, reactive power compensation devices may amplify the distortion, causing additional thermal loads on the transformer's windings and magnetic circuit. This can lead to a decrease in the transformer's rated power and potentially even failure. The thermographic examination of the transformer device can reveal hotspots, indicating areas of high temperature caused by the additional thermal load. Therefore, it is crucial to consider the impact of harmonic distortions when designing power grids in order to avoid potential equipment failures and ensure the reliability and safety of the power system.

2.5. The effect of reactive power compensation devices on harmonic distortion

Another component that substantially affects the level of harmonic distortion and the quality of electrical energy is a reactive power compensation device. The capacitor device is the most common means of correcting the power factor of power grids. Outdated equipment that does not have throttles to protect capacitors quickly fails in the presence of harmonic currents, and in addition, it leads to an increase in harmonic distortion in the system and sometimes the creation of emergency situations. Unfortunately, it is quite common for such devices to ignite, which leads to fires. In addition, when resonant phenomena occur, protective devices can be triggered, thereby reducing the reliability of the power supply (Bondarenko and Galich 2013; Ali et al. 2022). Figure 16 presents graphs showing the connection of a capacitor device without throttles to a device.



Fig. 16. Connecting a capacitor device without capacitor protection throttles

Rys. 16. Podłączenie urządzenia kondensatorowego bez dławików zabezpieczających kondensatory

When the device was turned on, the voltage level increased from 398 to 405 V. Active power increased from 1,083 to 1,085 kW. Reactive power is reduced from 475 to 100 kVar. Nonlinear

voltage distortion increases from 2 to 2.8%. Thus, the voltage has substantially increased, and the level of harmonic voltage distortion has also increased, and this negatively affects all connected equipment. Active power consumption has also increased. The next graphs display the situation when connecting a capacitor device with 189 Hz throttles (Fig. 17).



Fig. 17. Connecting a capacitor device with 189 Hz protective throttles

Rys. 17. Podłączenie urządzenia kondensatorowego z dławikami ochronnymi 189 Hz

The voltage level increases from 400 to 402 V. Active power is reduced from 1,025 to 1,000 kW. Reactive power is reduced from 360 to 50 kVar. Nonlinear voltage distortion is reduced from 2.7 to 2.4%. In other words, a properly selected compensation device with protective throttles, in addition to reducing harmonic distortion, enables a substantial reduction in active power consumption. It can be said that 25 kW per hour is 219,000 kW per year. This additional factor substantially reduces the payback period of such systems. Unfortunately, it is very difficult to calculate this effect through preliminary calculations, but in practical application, it is very noticeable.

3. Discussion

Based on the previous graphs, connecting capacitors leads to an increase in the voltage in the system. It is necessary to consider this phenomenon so that the voltage does not exceed the permitted limits. This principle is used to create systems designed to stabilize the voltage in the network. One such example is the study by [Bagdadee et al. \(2020\)](#) in which a promising control model using industrial super-dynamic voltage recovery equipment is presented. [Tu et al. \(2019\)](#) presented an effective strategy for increasing the quality of the voltage of sensitive loads with the optimal use of dynamic voltage recovery (DVR). The main goal of their method is to mitigate the phase voltage surge on the load side and reduce the total voltage failure compensation time ([Bondarenko and Galich 2015](#); [Borisov et al. 1998](#)).

Recently, devices based on active filters (APF – active power filters) have replaced conventional capacitor-based power factor correction devices. Due to their ability to work both for the generation and consumption of reactive power, they are indispensable in modern networks, where the nature of the load changes from inductive to capacitive during the day. In addition, they are also able to reduce the level of harmonics in the system, injecting out-of-phase current with harmonic. However, these are not all the features of APF. In their study, [Kumar et al. \(2022\)](#) suggest using an active filter as a DVR.

In the paper of [Dubey et al. \(2022\)](#) an APF based on a reduced-order generalized integrator (ROGI) is proposed for an active power shunt filter. ROGI requires only half of the calculations of a conventional second-order generalized integrator (SOGI) and is implemented in a stationary reference frame without using rotating coordinate transformations. Thus, the proposed spectral harmonics correlation (SHC) method requires lower calculation costs than conventional SHC schemes. In addition, ROGI is sensitive to both sequence and frequency; it can be assigned an individual gain and bandwidth for different harmonics of the sequence and frequency.

Despite the excellent capabilities of technologies such as APF, passive filters remain a fairly powerful and reliable means of reducing harmonic distortion and solving problems of electrical energy quality. During the practical modelling of the system, which was discussed earlier, the installation of a passive filter allowed changing the level of harmonic distortion in the system to comply with the [IEEE 519-2014 standard \(2014\)](#). An example of the practical use of passive filters is described in the study by [Park et al. \(2021\)](#). Passive filters with a rated voltage of 22 kV not only helped to reduce the harmonic level at the PCC point but also substantially reduce voltage fluctuations caused by dynamic reactive power consumption. A paper by [Almutairi and Hadjiloucas \(2019\)](#) proposes a new method for reducing distortion using the non-linearity current index (NLICI) in order to determine the value of a single-tuned passive filter compensator shunt (STPF) in non-sinusoidal power supply systems for the purposes of maintaining the power factor within the required limits. STPF is also used by [Abbas et al. \(2021\)](#) to reduce harmonic distortion caused by the spread of network inverters in residential electrical systems. The problem of optimal filter placement is solved due to water cycle algorithms.

Rapid growth in the number of electric vehicles around the world has set serious challenges for researchers to assess their impact on the quality of electrical energy in residential networks. In their joint study, [Rodriguez-Pajaron et al. \(2021\)](#) use Monte Carlo simulations to obtain a probabilistic estimate of the quality of electricity in accordance with the penetration levels of non-linear loads for the period until 2030, including their interaction with photovoltaic systems. The proliferation of photovoltaic systems leads to the need to develop methods for assessing the stability of such micro-networks and calculating the quality indicators of electrical energy ([Azieva et al. 2021](#)). In the report by [Wu et al. \(2019\)](#), the energy quality is analyzed both on the AC side of the system and on the DC side. The area of direct current has also become relevant recently as a result of the rapid development of renewable energy.

The spread of non-linear consumers has even affected such a special area as nuclear power ([Alameri and Alkaabi 2018](#)). In the study by [Nassar et al. \(2020\)](#), the results showed that the quality parameters of the electrical energy of the research reactor network are normal. The simulation was conducted using the ETAP software product, which also enables the performing of necessary calculations of power grids for compliance with harmonic distortion standards. Summarizing the results of the study and trends in the development of power grids, it can be stated that new technologies, such as AHF filters, are replacing standard devices with capacitors and are becoming increasingly popular due to their versatility. The ability of active filters to compensate for the capacitive component and the distribution of loads with the capacitive component of current makes them very relevant in modern conditions. Therewith, the simultaneous ability to reduce harmonic distortion is also a very demanding feature, especially when it is necessary to meet the requirements of the [IEEE 519-2014 standard \(2014\)](#). Given the fact that new algorithms are being developed for these devices that allow them to be used as voltage stabilisers, the spread of this technology is inevitable.

Conclusions

This practical study of the capabilities of the Schaffner PQS software has shown that new modern methods for modelling power grids and assessing the impact of nonlinear loads on them are emerging. The results of modelling a typical scheme for many enterprises has shown that to ensure the level of harmonic distortion within the IEEE 519-2014 standard, it is necessary to install a passive filter on the frequency converter. The software tools allow intuitive calculations and the obtaining of the necessary data and graphical reports in an accessible way. It is very useful that calculations can be made for each element of the system, so it is possible to analyse the functional features of the product. The article thoroughly examines the concept of power factor and its characteristics in the presence of harmonic distortions, as well as the impact of such distortions on various elements of power grids, such as cable lines and transformers. It is crucial to consider this factor when designing power grids as failure to

do so can result in significant consequences, as evidenced by the thermographic examination of a power transformer. Reactive power compensation devices, for example, may exacerbate distortion in the presence of such harmonic distortions. To support this claim, the article presents actual measurement data obtained from the operation of reactive power compensation devices, which demonstrate that reducing harmonic distortion results in considerable savings in active energy.

The literature reviewed during the study highlights the growing importance of addressing harmonic distortion issues in power grids. Various new approaches and technologies are being developed to mitigate their impact on the grid. With the significant proliferation of photovoltaic systems, which are known to be generators of harmonic distortion, challenges have increased. Similarly, the surge in the number and capacity of charging stations for electric vehicles is creating new challenges that require attention from the scientific community. Furthermore, harmonic distortion problems are pervasive, affecting everything from household outlets to nuclear power plants.

References

- ABBAS et al. 2021 – ABBAS, A.S., EL-SEHIEMY, R.A., EL-ELA, A.A., ALI, E.S., MAHMOUD, K., LEHTONEN, M. and DARWISH, M.M.F. 2021. Optimal harmonic mitigation in distribution systems with inverter based distributed generation. *Applied Sciences* 11(2), DOI: 10.3390/app11020774.
- ALAMERI, S.A. and ALKAABI, A.K. 2018. Assessment of a nuclear reactor-thermal energy storage coupled system. *Transactions of the American Nuclear Society* 1(118), pp. 693–695.
- ALI et al. 2022 – ALI, M., ALKAABI, A.K. and ADDAD, Y. 2022. Numerical investigation of a vertical triplex-tube latent heat storage/exchanger to achieve flexible operation of nuclear power plants. *International Journal of Energy Research* 46(3), pp. 2970–2987, DOI: 10.1002/er.7357.
- ALMUTAIRI, M.S. and HADJILOUCAS, S. 2019. Harmonics mitigation based on the minimization of non-linearity current in a power system. *Designs* 3(2), pp. 29–32, DOI: 10.3390/designs3020029.
- ATAMANYUK et al. 2019 – ATAMANYUK, I., SHEBANIN, V., KONDRATENKO, Y., VOLOSUYUK, Y., SHEPTYLEVSKIY, O. and ATAMANIUK, V. 2019. Predictive Control of Electrical Equipment Reliability on the Basis of the Non-linear Canonical Model of a Vector Random Sequence. [In:] *International Conference on Modern Electrical and Energy Systems, MEES 2019*, pp. 130–133. Kremenchuk: Institute of Electrical and Electronics Engineers, DOI: 10.1109/MEES.2019.8896569.
- AZIEVA et al. 2021 – AZIEVA, G. KERIMKHULLE, S., TURUSBEKOVA, U., ALIMAGAMBETOVA, A. and NIYAZBEKOVA, S. 2021. Analysis of access to the electricity transmission network using information technologies in some countries. *E3S Web of Conferences* 258, DOI: 10.1051/e3sconf/202125811003.
- BAGDADEE et al. 2020 – BAGDADEE, A.H., KHAN, M.Y.A., DING, H., CAO, J., ZHANG, L. and DING, Y. 2020. Implement industrial super-dynamic voltage recovery equipment for power quality improvement in the industrial sector. *Energy Reports* 6(9), pp. 1167–1175, DOI: 10.1016/j.egy.2020.11.058.
- BATRAKOV et al. 2017 – BATRAKOV, D.O., ANTYUFYEVA, M.S., ANTYUFYEV, A.V. and BATRAKOVA, A.G. 2017. Remote sensing of plane-layered media with losses using UWB signals. [In:] *11th International Conference on Antenna Theory and Techniques, ICATT 2017*, pp. 370–373. Kyiv: Institute of Electrical and Electronics Engineers, DOI: 10.1109/ICATT.2017.7972666.
- BHAVANI et al. 2022 – BHAVANI, R., PRABHA, N.R. and JAWAHAR, M. 2022. An ultra-capacitor integrated dynamic voltage restorer for power quality enhancement in a three-phase distribution system using an

- adaptive neuro-fuzzy interference system controller. *Revue Roumaine des Sciences Techniques Serie Electrotechnique et Energetique* 67(4), pp. 383–388.
- BONDARENKO et al. 2018 – BONDARENKO, I.N., GORBENKO, E.A. and KRASNOSHCHOK, V. I. 2018. Microwave switch based on a combined coaxial-waveguide tee for a cavity pulse shaper. *Telecommunications and Radio Engineering* 77(5), pp. 391–397, DOI: 10.1615/TelecomRadEng.v77.i5.30.
- BONDARENKO, I.N. and GALICH, A.V. 2013. Electrodeless lamps based on the resonant irregular microwave structures. *23rd International Crimean Conference Microwave and Telecommunication Technology CriMiCo 2013–2013*, Conference Proceedings 1, pp. 1063–1064.
- BONDARENKO, I.N. and GALICH, A.V. 2015. Measuring resonant transducers on the basis of microstrip structures. *Telecommunications and Radio Engineering* 74(9), pp. 807–814, DOI: 10.1615/TelecomRadEng.v74.i9.60.
- BONDARENKO, I.N. and GORBENKO, E.A. 2018. Forming the powerful microwave pulses using resonator storage. *Telecommunications and Radio Engineering* 77(15), pp. 1311–1319, DOI: 10.1615/telecomradeng.v77.i15.20.
- BORISOV et al. 1998 – BORISOV, Y., KORZHYK, V. and REVO, S. 1998. Electric and magnetic properties of thermal spray coatings with an amorphous structure. *Proceedings of the International Thermal Spray Conference* 1, pp. 687–691, DOI: 10.31399/asm.cp.itsc1998p0687.
- DUBEY et al. 2022 – DUBEY, A.K., MISHRA, J.P. and KUMAR, A. 2022. Comparative analysis of ROGI based shunt active power filter under current fed and voltage fed type non-linear loading condition. *IFAC-PapersOnLine* 55(1), pp. 156–161, DOI: 10.1016/j.ifacol.2022.04.026.
- DURAN-TOVAR et al. 2013 – DURAN-TOVAR, I.C., DUARTE, O.G. and PAVAS, A. 2013. Effects of stationary Power Quality disturbances on lifetime of low voltage conductors. [In:] *VII International Symposium on Quality of Electric Power*, pp. 1–6, Medellin: SICEL.
- Electrical Installation Guide 2018. [Online] <https://fenix.tecnico.ulisboa.pt/downloadFile/1126518382241064/Electrical-Installation-Guide-2018.pdf> [Accessed: 2022-06-14].
- FIALKO et al. 1994 – FIALKO, N., PROKOPOV, V.G., MERANOVA, N.O., BORISOV, Y., KORZHIK, V.N. and SHERENKOVSKAYA, G.P. 1994. Single particle-substrate thermal interaction during gas-thermal coatings fabrication. *Fizika i Khimiya Obrabotki Materialov* (1), pp. 70–78.
- FUCHS, E.F. and MASOUM, M.A.S. 2008. *Power quality in power systems and electrical machines*. Amsterdam: Elsevier.
- Harmonic mitigation 2009. [Online] <https://electronicpowersolutions.com/wp-content/uploads/2014/02/Schneider-Harmonic-Mitigation-Solution-Handbook.pdf>. [Accessed: 2022-06-14].
- IEEE 519-2014 standard 2014. [Online] <https://www.elspec-ltd.com/ieee-519-2014-standard-for-harmonics/> [Accessed: 2022-06-14].
- KAMENKA, A. 2014. Six tough topics about harmonic distortion and power quality indices in electric power systems. Luterbach: The Schaffner Group.
- Key components for power factor correction in 50 Hz mains 2018. [Online] <http://surl.li/eyjrv> [Accessed: 2022-06-14].
- KHARLAMOV et al. 2015 – KHARLAMOV, M.YU., KRIVTSUN, I.V., KORZHYK, V.N., RYABOVOLYK, Y.V. and DEMYANOV, O.I. 2015. Simulation of Motion, Heating, and Breakup of Molten Metal Droplets in the Plasma Jet at Plasma-Arc Spraying. *Journal of Thermal Spray Technology* 24(4), pp. 659–670, DOI: 10.1007/s11666-015-0216-4.
- KORZHYK et al. 2017 – KORZHYK, V.N., KULAK, L.D., SHEVCHENKO, V.E. and KVASNITSKIY, V.V. 2017. New equipment for production of super hard spherical tungsten carbide and other high-melting compounds using the method of plasma atomization of rotating billet. *Materials Science Forum 898 MSF*, pp. 1485–1497, DOI: 10.4028/www.scientific.net/MSF.898.1485.

- KUMAR et al. 2022 – KUMAR, C., GHOSH, P. and CHATTERJEE, S. 2022. Enhancement of power quality by mitigating of sag and swell problem in power system using DVR. *IFAC-PapersOnLine* 55(1), pp. 131–137, DOI: 10.1016/j.ifacol.2022.04.022.
- MALENGRET, M. and GAUNT, T. 2020. *Active currents, power factor, and apparent power for practical power delivery systems*. Cape Town: University of Cape Town.
- MANOJ et al. 2022 – MANOJ, V., KHAMPARIYA, P. and PILLA, R. 2022. A review on techniques for improving power quality: research gaps and emerging trends. *Bulletin of Electrical Engineering and Informatics* 11(6), pp. 3099–3107, DOI: 10.11591/eei.v11i6.4396.
- NASSAR et al. 2020 – NASSAR, S.R., EISA, A.A., SALEH, A.A., FARAHAT, M.A. and ABDEL-GAWAD, A.F. 2020. Evaluating the impact of connected non-linear loads on power quality – A nuclear reactor case study. *Journal of Radiation Research and Applied Sciences* 13(1), pp. 688–697, DOI: 10.1080/16878507.2020.1828018.
- NIYAZBEKOVA et al. 2022 – NIYAZBEKOVA, S., YESSYMKHANOVA, Z., KERIMKHULLE, S., BROVKINA, N., ANNENSKAYA, N., SEMENOV, A., BURKALTSEVA, D., NURPEISOVA, A., MAISIGOVA, L. and VARZIN, V. 2022. Assessment of Regional and Sectoral Parameters of Energy Supply in the Context of Effective Implementation of Kazakhstan’s Energy Policy. *Energies* 15(5), DOI: 10.3390/en15051777.
- O’CONNELL et al. 2012 – O’CONNELL, K., BARRETT, M., BLACKLEDGE, J. and SUNG, A. 2012. Cable heating effects due to harmonic distortion in electrical installations. [In:] *International Conference of Electrical and Electronics Engineering 2012*, pp. 1–8, London: International Association of Engineers.
- PARK et al. 2021 – PARK, B., LEE, J., YOO, H. and JANG, G. 2021. Harmonic mitigation using passive harmonic filters: Case study in a steel mill power system. *Energies* 14(8), DOI: 10.3390/en14082278.
- Passive Harmonic Filters 2020. [Online] https://www.schaffner.com/fileadmin/user_upload/Media/Downloads/installation-manual-ecosine-evo-rev08-en.pdf [Accessed: 2022-06-14].
- RODRIGUEZ-PAJARON et al. 2021 – RODRÍGUEZ-PAJARÓN, P., HERNÁNDEZ, A. and MILANOVIĆ, J.V. 2021. Probabilistic assessment of the impact of electric vehicles and nonlinear loads on power quality in residential networks. *International Journal of Electrical Power & Energy Systems* 129, DOI: 10.1016/j.ijepes.2021.106807.
- Schaffner power quality simulator user manual 2016. [Online] <https://pqs.schaffner.com/manual.pdf>. [Accessed: 2022-06-14].
- STAVINSKII et al. 2019 – STAVINSKII, A., SHEBANIN, V., AVDIEIEVA, E., TSYGANOV, A., STAVINSKIY, R. and SADOVOY, O. 2019. Dependence of the Indicators of Three-phase Transformers with Planar Plate Magnetic Wires from Variants of Rod Configuration. [In:] *International Conference on Modern Electrical and Energy Systems, MEES 2019*, pp. 102–105. Kremenchuk: Institute of Electrical and Electronics Engineers, DOI: 10.1109/MEES.2019.8896451.
- TU et al. 2019 – TU, C., GUO, Q., JIANG, F., WANG, H. and SHUAI, Z. 2019. A comprehensive study to mitigate voltage sags and phase jumps using a dynamic voltage restorer. *IEEE Journal of Emerging and Selected Topics in Power Electronics* 8(2), pp. 1490–1502, DOI: 10.1109/JESTPE.2019.2914308.
- UTE C15-112 standard 2000. [Online] https://arenatecnica.com/en/technical-standards/ute_c15-112. [Accessed: 2022-06-14].
- WU et al. 2019 – WU, M., NIU, X., GAO, S. and WU, J. 2019. Power quality assessment for AC/DC hybrid micro grid based on on-site measurements. *Energy Procedia* 156, pp. 396–400, DOI: 10.1016/j.egypro.2018.11.105.

Juliya MALOGULKO, Vira TEPTIA, Natalia OSTRĄ, Olena SIKORSKA, Kateryna POVSTIANKO

Narzędzia do modelowania poziomu zniekształceń harmonicznych w sieciach elektroenergetycznych i ich wpływ

Streszczenie

Wpływ zniekształceń harmonicznych na sieci elektroenergetyczne jest ważnym zagadnieniem we współczesnych sieciach elektroenergetycznych w wyniku szerokiego zastosowania obciążeń nieliniowych. Celem niniejszego artykułu jest zbadanie problemu zniekształceń harmonicznych w sieciach elektroenergetycznych i ich wpływu na elementy sieci, takie jak linie kablowe i transformatory. Do modelowania sieci elektroenergetycznych wykorzystano oprogramowanie Schaffner PQS. Przedstawiono nowe techniki modelowania sieci elektroenergetycznych i znajdowania rozwiązań technicznych zgodnych ze standardem IEEE 519-2014. Badanie wykazało, że zniekształcenia harmoniczne mogą prowadzić do dodatkowego obciążenia cieplnego linii kablowych i zmniejszać moc dostępną dla transformatorów, co może zmniejszać ich wydajność. Zastosowanie nowoczesnego oprogramowania zmniejsza czas i złożoność obliczeń, a dostępność rozwiązań programowych do ograniczania zniekształceń harmonicznych upraszcza tworzenie rozwiązań spełniających tę normę. Korzystając z metod przedstawionych w badaniu, można ulepszyć rozwiązania inżynierskie, zwiększyć niezawodność systemów elektrycznych i zmniejszyć straty energii elektrycznej. Może to poprawić efektywność pracy inżynierów-projektantów i specjalistów technicznych zaangażowanych w eksploatację sieci elektroenergetycznych.

Słowa kluczowe: jakość energii, harmonia mocy, obliczenia harmoniczne, technologie energooszczędne, odbiorniki nieliniowe

