

IRENA HARAŃCZYK

ANODIC DISSOLUTION OF METAL POWDERS**ANODOWE ROZTWARZANIE PROSZKÓW METALI**

The paper presents the results of some preliminary investigations on electrolytic separation of chemical elements contained in anode slimes. A new type of electrolyzer is presented which can enable a continuous transport of the electrolysis products to a receiver. Then, both the kinetics and the mechanism of anodic dissolution of powder electrodes, taking as example silver powder are discussed. An empirical formula allowing to control this process by means of such parameters as powder mass, current density, electrolyte concentration and grain structure has also been derived. Finally, a procedure for conducting anodic dissolution so as to reverse passivation and to increase the fraction reacted is suggested.

W pracy przedstawiono wyniki wstępnych badań dotyczących elektrolitycznego rozdzielania pierwiastków wchodzących w skład szlamów anodowych. Przedstawiono projekt nowego typu elektrolizera, w którym produkty są w sposób ciągły odprowadzane do odbieralnika. Omówiono kinetykę i mechanizm anodowego roztwarzania elektrod proszkowych na przykładzie proszku srebra i wyprowadzono wzór empiryczny pozwalający sterować tym procesem za pomocą zmian parametrów takich jak masa proszku, gęstość prądu, stężenie elektrolitu a także struktura ziarnowa. Zaproponowano sposób roztwarzania anodowego, który pozwala na cofnięcie pasywacji i zwiększenie stopnia przereagowania

1. Introduction

Intermediate metallurgical industry products often occur as powders, slags or slimes. They are sources of a large number of chemical elements. For example, copper electrorefining slimes contain not only basic constituents, like silver and lead, but also copper, bismuth, tin, antimony, arsenic, and even small amounts of gold and platinum.

In order to recover the constituents mentioned above, anodic slime is subject to complex technologies, viz. to fire, chemical or electrochemical processes. Here a question arises – whether it is possible to have such a complex process simplified by reducing it down to one stage only – electrolysis. Thus is considered a possibility of recovering respective elements through successive processes of cathodic reduction of sparingly soluble compounds is considered, so as to obtain metal powders, followed by anodic dissolution of those metals in the form of powders.

From the thermodynamic point of view the suggested method of the slime constituents recovery is possible. The basis of these considerations is free enthalpy dependence ΔG_i of the i -constituent on the equilibrium potential E° of this constituent:

$$\Delta G_i = -z_i F E^\circ$$

where F is Faraday's constant and z_i the number of electrons.

Here however the problem of the anodic process mechanism change connected with the necessity of constructional changes of the electrolytic system appears. In the traditional electrolyzers of solid metal anodes are connected to the current source, the connection being outside the electrolyzer. The transport of electrons to the reaction surface takes place with the speed so much bigger than the metal-solution reaction speed that it can be neglected. Therefore in the examination of electrode kinetics processes electron transport is not at all taken into consideration.

In case of polycrystalline materials such as loose anodic slimes or slag, the current has to be supplied by a solid substrate on which this material is placed. Supplying the electric current to the soluble part of the polycrystalline electrode takes place inside the electrolyzer where the electrolyte can penetrate through the grains to the substrate surface. Here we can talk about a mixed ionic-electron conductivity.

The acceptance of the postulated method of recovery of anodic slime constituents entails, however, a new type of electrolyzers. A design of such a system is presented in Fig.1

In the system under consideration, anode [1] is the graphite lining of the electrolytic cell and the electrorefining anodic slime piled up on it. The cathode is a metal strip [2] moving through a gear [3] on a cylinder of organic glass [4] placed in an electrolytic cell, and on a cylinder with a metal raceway [5] placed in receiver [6]. Current is supplied [7] to cathode through a copper sliding wheel, arranged in the cylinder axis, and through a graphite brush. In the receiver, cathodic deposit is rinsed onto the filters in a strong water stream and removed with a sweeper [8]. The process course is controlled by the potential measuring system – salt bridges [9] – connecting the anode to a calomel electrode [10]. The electrolytic solution can circulate due to a peristaltic pump [11].

An essential feature of this design is the construction of the cathode – realized as a moving strip – which operates both as an electrode and a transmission belt. The strip-cathode is moved at a given speed [frequency], ensuring a continuous removal of the pure slime constituent out of the electrolyzer system; and consequently, the co-deposition of undesired admixtures can be prevented.

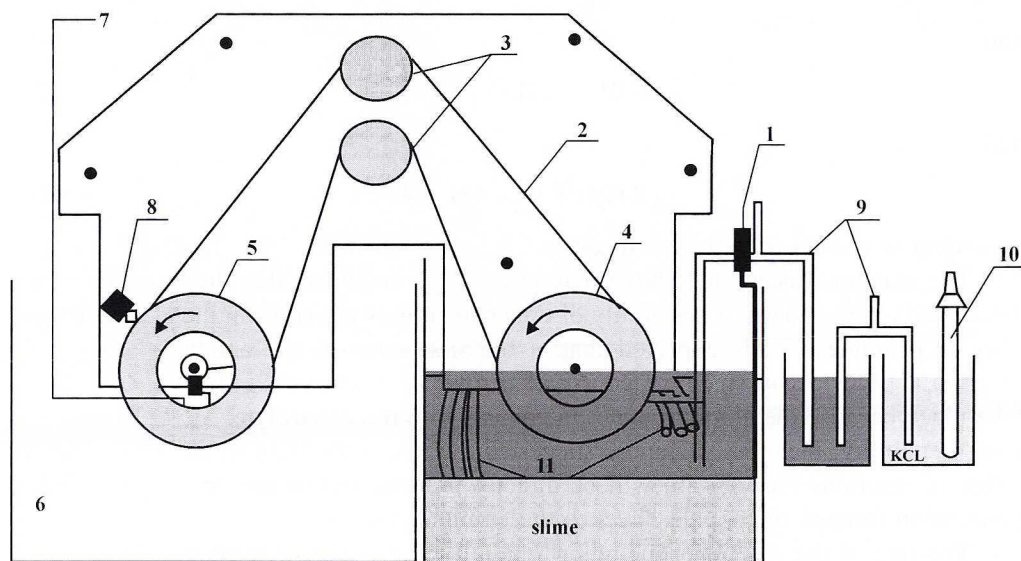

Fig. 1. Electrolyzer for the separation of anode slime components

The system described above was already used for the electrolysis of copper powder of given granulation grade [1]. It was also applied for obtaining a fine-grained lead deposit, since the adjustment of the strip shift speed can guarantee the control of the electrocrystallization process.

A modification of the process of recovery of anode slime constituents requires however a solution of numerous basic problems – viz. the determination of the kinetics and the mechanism of the cathodic and anodic processes occurring on electrodes made of powder, i.e. on polycrystalline electrodes. As an example of such investigations the dissolution of silver powder and cathodic reduction of AgCl were carried out.

The results of investigations on the kinetics and the mechanism of the cathodic reduction of AgCl have already been shown in previous publications [3], [4], [5], [6] and [7]. This paper is aimed, however, at presenting some information obtained during the investigations of the process of anodic dissolution of silver powder. Because of that a much simpler measuring system has been applied, making use of an immobile cathode in the form of Ti surrounding strip.

As has been mentioned above the fundamental difference between a powder electrode and one made of solid metal is that the former consists of two parts:

1. a layer of metal powder constituting the soluble part of the anode
2. a solid substrate made of a conductor [in this case – graphite] constituting the insoluble part of the electrode.

Taking into consideration the electrode structure, two anodic reactions are likely to occur:



and



and



according to the pH value of the medium.

The reactions mentioned above may proceed on condition that the potential of the electrode is high enough; a possibility of transport of ions to and from the electrode must also be guaranteed. It is expected that at the first stage of the anodic process, only reaction [1] will occur, since the course of neither of reactions (2a) or (2b) is likely to take place because the graphite is not in contact with the electrolyte. Silver powder has poor wettability; therefore, it can be suggested that the probability of the occurrence of either of reactions (2a) or (2b) will be directly proportional to the rate of the solution penetration through the powder layer to the graphite surface.

The rate of the solution penetration through the powder layer may influence both the fraction reacted and the yield of the anodic process of silver dissolution. And, if t_F – time of anodic dissolution of the entire silver sample of initial mass m_o – is shorter than t_g – time of solution penetration through the powder layer to the graphite surface, then reaction (1) will proceed to the end before process (2) becomes thermodynamically possible (on condition that concentration polarisation is prevented).

Instead, assuming that time t_g – after which the solution arrives at the graphite surface – is appreciably shorter than t_F , the current efficiency is likely to diminish if both reactions (1) and (2) run paralelly; or else, the fraction reacted X is likely to decrease

$$X = \frac{m_{rozp}}{m_o}, \quad (3)$$

where m_r stands for the silver mass coming into the solution in consequence of anodic dissolution in time t_p , in which a jump change in the potential will take place so as to reach the value typical of reaction (2).

This paper is aimed at checking which of the reactions (1) or (2) is decisive for the fraction of silver powder reacted in the process of anodic dissolution, as well as which factors might have a considerable effect upon that value. Current intensity and electrolyte concentration were the parameters considered as those which decide about occurrence of the concentration polarisation; attention was also focused upon the silver powder structure that affects the time of solution penetration through the powder layer.

One should remember that there are a number of papers [8]–[18] on powder electrodes, these, however, being most often merely theoretical considerations based on models not taking into account the specific characteristics of this system.

The present paper is of cognitive character, but is also aimed at solving a practical industrial problem – that is a modification of the process; the description of the anodic process is based mainly upon a large number of experiments performed.

2. Experimental

The investigations of the anodic dissolution of silver powder were carried out with an anode consisting of a graphite substrate, its active area being $S = 10 \text{ cm}^2$, on which the following compounds were placed during the successive measurements:

1. silver powder obtained in the cathodic reduction of AgCl , grain sizes: $30\text{--}1000 \mu\text{m}$.
2. silver powder obtained electrolytically, grain sizes: $30\text{--}1000 \mu\text{m}$. Average silver powder mass: $(5.26 \pm 0.2) \text{ g}$
3. silver plate dia 3.5 cm ($S_{\text{pt}} = 9.6 \text{ cm}^2$)

In all measurements (except for those in which the effect of the concentration of Ag^+ ions was examined) the same type of electrolyte was used, namely: 0.25 m Ag^+ , 0.5 m NaNO_3 , 0.08 m HNO_3 in 1 dm^3 of solution. The reagents applied were ppa grade, and all solutions were prepared using distilled water.

The measurements were performed galvanostatically on the apparatus presented in Fig 2. This design is simplified as compared to the planned electrolytical system, since the present work focuses solely on the anodic process.

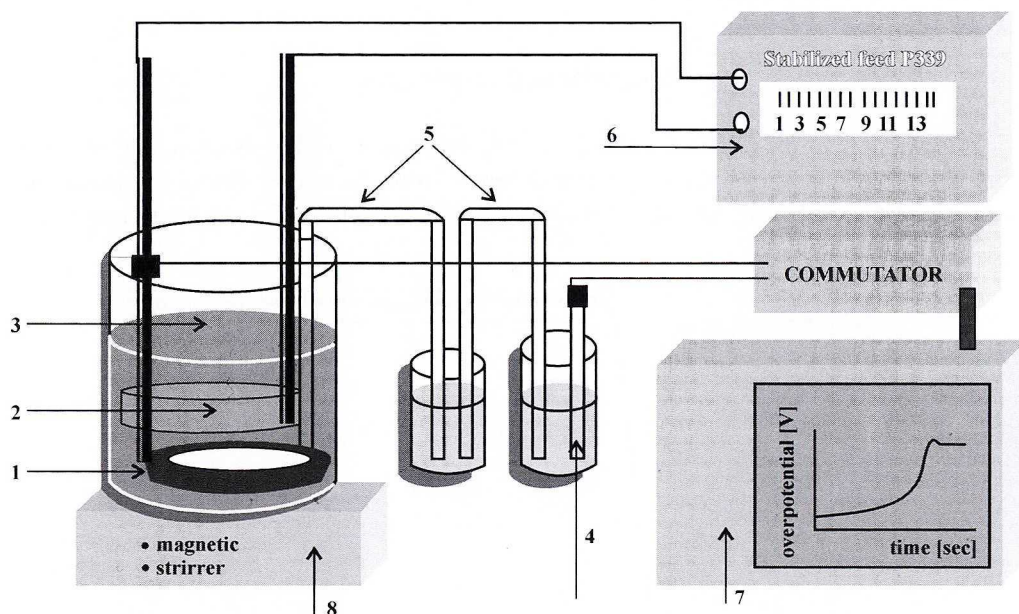

Fig. 2. Diagram of the measuring system for anodic dissolution of silver powder

1. Anode consisting of a graphite substrate, insulated from inside, covered with a silver powder layer
2. Clamp-shaped cathode of titanium plate (while making measurements – placed at the same level as the anode)
3. Beaker filled with electrolyte
4. Silver electrode – serving as reference electrode – immersed in the same solution as in the electrolyzer
5. Salt bridge
6. Stabilised power supply
7. Computer
8. Magnetic stirrer

The silver powder was first subject to sieve analysis. Samples, weighed on an analytical balance with an accuracy of 10^{-4} g, were taken from a fraction having determined grain sizes. The powder was put on the graphite substrate. After fixing the electrodes in the measuring cell and making connections to a stabilised power supply unit, the electrolyte was poured in and the measurements were started. During the measurements the solution was being mixed with a magnetic stirrer.

The anode potential was measured against the silver electrode immersed in the same solution as that in the electrolyzer. Such a measuring system could guarantee an accuracy as high as 10^{-4} V. The potential measurements enabled the control of the course of the anodic process. A rapid increase in the potential up to a value over 400 mV vs. $\text{Ag}/\text{Ag}^+ = 1200$ mV vs. normal hydrogen electrode indicated the end of the anodic dissolution. A copper coulometer was connected to the system during the measurements so as to determine precisely the quantity of charge which passed through the system in the course of electrolysis.

The fraction reacted and the current efficiency were determined gravimetrically.

Investigations of the silver powder before and after measurements were performed on a scanning electron microscope.

3. Results and conclusions

An example of the relation – powder anode potential vs time – is presented in Fig 3. This is a typical galvanostatic curve not different from the curves found for electrodes made of solid metals. Nevertheless, time t_p , after which a jump of the potential up to the

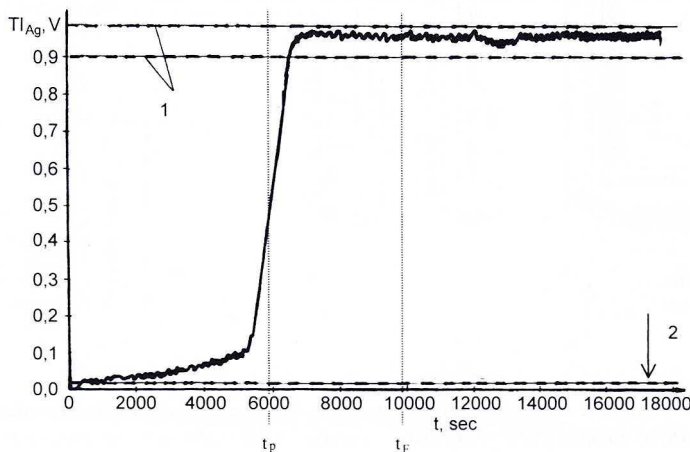

Fig 3. Galvanostatic curve of anodic dissolution of silver powder

1. Discharge potential of oxygen on graphite, determined in a separate measurement
2. Dissolution potential of the silver plate

t_F – time needed for entire dissolution of silver powder of mass m_o

t_p – real dissolution time of silver powder of mass m_o

value corresponding to oxygen anodic evolution occurred, is shorter than the expected time t_F resulting from Faraday's law. It means that the silver powder is subject to passivation.

In compliance with formula (3), the fraction reacted can be expressed as the ratio of the mass of the powder that has passed into the solution as a result of anodic dissolution m_r to initial mass m_o . By applying Faraday's law, it can also be presented as a ratio of the passivation time and Faraday time for a powder of a given mass and for the given current intensity:

$$X = \frac{m_r}{m_o} = \frac{kit_p}{kit_F} = \frac{t_p}{t_F}, \quad (4)$$

where k is the electrochemical equivalent of silver, and i – current intensity.

The results of the investigations of the effect of such parameters, as sample mass, current intensity, and electrolyte concentration upon the passivation time and the fraction reacted in the process of anodic dissolution of silver powder are presented collectively as graphs in Fig 4 accompanied by the equations 4b-4f determined on the basis of these graphs.

In Equations (4b) – (4f), the fraction reacted appears as a constant coefficient. This coefficient is (0.36 ± 0.03) in equation 4b; (0.33 ± 0.01) in equation 4d and (0.32 ± 0.01) in equation 4f. Taking into consideration the experimental mistake of the constant X one can assume that it is independent from the modified electrolysis parameters. As a result the average fraction reacted has been calculated on the level of (0.34 ± 0.2) . Accepting this simplification the above mentioned three dependencies can be presented as one generalized equation characteristic of a given silver powder:

$$t_p = X \frac{m_o}{ki} = 0.34 \frac{m_o}{ki}.$$

The analysis of the process of metal powder passivation, based upon the experimental results mentioned above, and especially on the proof that the change of the silver ions concentration of as much as the order of magnitude, does not influence the time of passivation, allows to state the lack of connection between the sudden potential rise and the changes in the electrolyte and allows to eliminate concentration polarisation as a cause of this phenomenon.

Another reason for passivation may be the formation of an oxide film on the metal surface. This type of passivation films is known for its stability, thus a transformation of a metal into active state entails depassivation performed either with current or with depassivation agents, (e.g. chlorides).

In order to find out if the experimentally found passivation state of silver powder is durable (whether it results from the formation of a surface oxide film), the powder left after anodic dissolution was filtered off, washed in water, dried, and finally subjected to dissolution again.

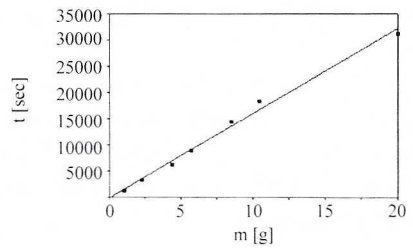
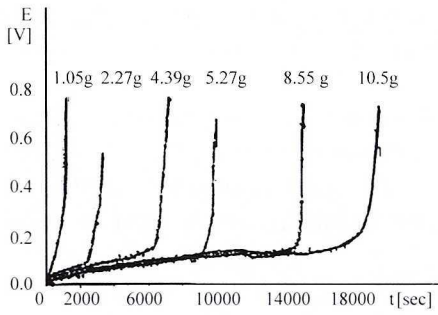

4 a

4 b

$$t_p = \frac{X}{ki} m_o = \frac{0.36}{ki} m_o$$

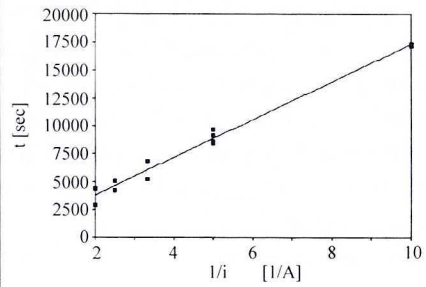
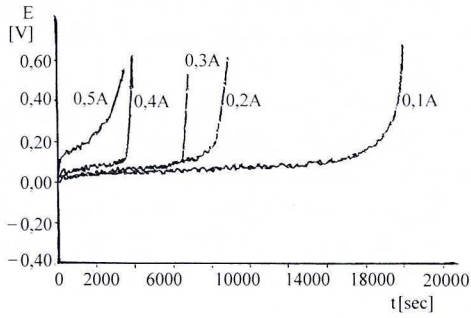

4 c

4 d

$$t_p = \frac{X m_o}{k} \frac{1}{i} = \frac{0.33 m_o}{k} \frac{1}{i}$$

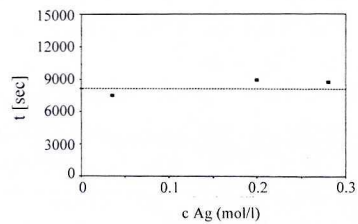
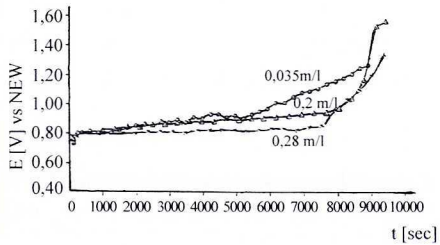

4 e

4 f

$$t_p = X m_o / ki = 0.32 m_o / ki$$

It was proved experimentally that the sample was conductive, and after connection to the power source, the potential value was exactly the same as it was during the first dissolution. Thus, the result obtained did indicate unequivocally that the inhibition of the dissolution of silver powder was not a result of the formation of a non-conductive oxide film, but was related to a change in the dissolution conditions.

Basing upon the above mentioned results of preliminary measurements it was assumed that a sudden rise in the potential value was attributed to the electrolyte penetration to the graphite surface. Consequently, investigations were carried out to check whether there was any relation between the fraction reacted of the silver powder and its grain size, structure and wetting time.

In the investigations of the effect of the structure on the fraction reacted, two types of silver powder were used: one was obtained in the cathodic reduction of AgCl, and the other – electrolytically from a AgNO₃ solution. Systematic measurements of the relation between the fraction reacted in the anodic process and grain sizes of the powders were performed.

At first investigation of both types of silver powder were conducted on a scanning electron microscope. Comparative results of that analysis are given below, taking as an example powder grains of diameters $150\ \mu\text{m} < \Phi < 200\ \mu\text{m}$. Photographs 5A and 5B present the powder morphology obtained in the cathodic reduction of AgCl whereas 5C and 5D – the other one obtained from electrolytic deposition.

The silver powder shown in Fig 5A, grain size $150\ \mu\text{m} < \Phi < 200\ \mu\text{m}$, consists of conglomerates of appreciably finer particles. Those are dendrites about $6\ \mu\text{m}$ long and fine crystallites of a diameter of approx. $3\ \mu\text{m}$. Small constituents of the conglomerates are shown separately in Fig 5A, the magnification value being more than 13 times larger than in Fig 5 B. Those particles are bridged with each other, however, those bridges can be easily broken. The conglomerates presented constitute a kind of sponge, easily absorbing in an electrolytic solution.

The electrolytic powder grains, separated on sieves of 150–200 μm grade, have a structure far different from the grains previously described, obtained from cathodic reduction of AgCl. It is visible in Figs 5C and 5D. Those grains exhibit a compact, polyhedral structure.

It seems that the differences observed in the grain structure can influence the course of the process of anodic powder dissolution. Below, Figs 6A, 6B and 6C, present the appearance of powders upon completion of the anodic process. They refer to the electrolytic powder before the dissolution process presented in Figs 5C and 5D.

←

Fig. 4. Effect of electrolysis parameters upon anodic dissolution of silver powder

- a) galvanostatic curves of anodic dissolution of silver powder for different masses of silver powder
- b) relation between anodic dissolution and initial mass of silver powder
- c) galvanostatic curves of anodic dissolution of silver powder at different current intensities
- d) relation between the time of anodic dissolution of silver powder and current intensity
- e) galvanostatic curves of anodic dissolution of silver powder for different concentrations of silver ions
- f) effect of Ag⁺ ion concentration upon the time of anodic dissolution of silver powder. Oxygen electrode equilibrium potential is marked with a dashed line

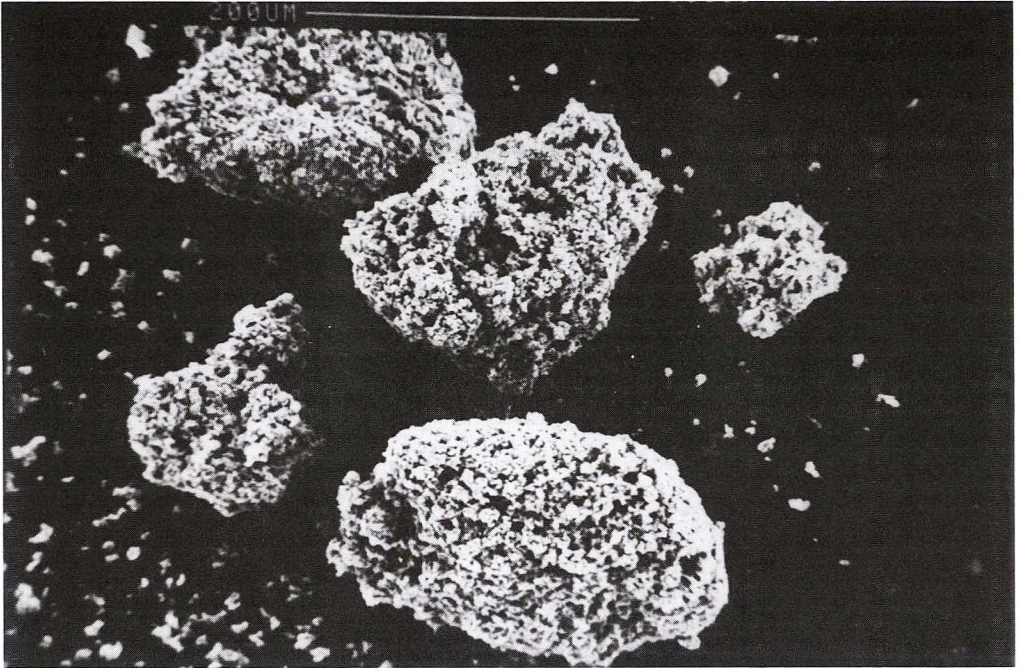

5A Silver powder obtained from cathodic reduction of AgCl; $150\ \mu\text{m} < \Phi < 200\ \mu\text{m}$; $P = 150\times$

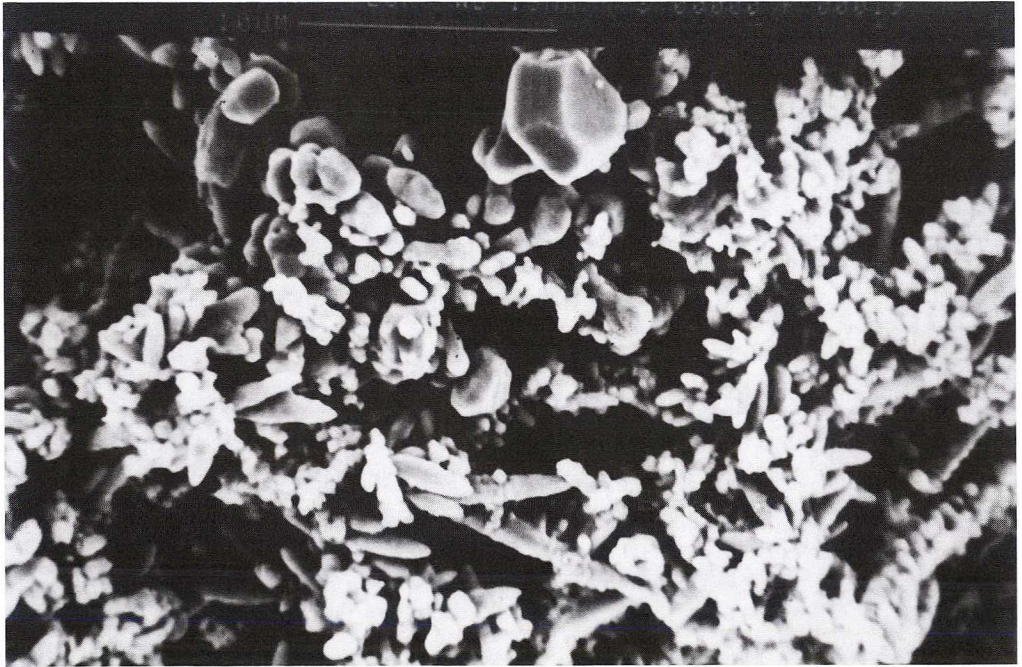

5B Silver powder obtained from cathodic reduction of AgCl; $150\ \mu\text{m} < \Phi < 200\ \mu\text{m}$; $P = 2000\times$

Fig. 5. Comparative list of the scanning analysis results of the initial silver powder, grain diameters: $150\ \mu\text{m} < \Phi < 200\ \mu\text{m}$, obtained in the cathodic reduction of AgCl

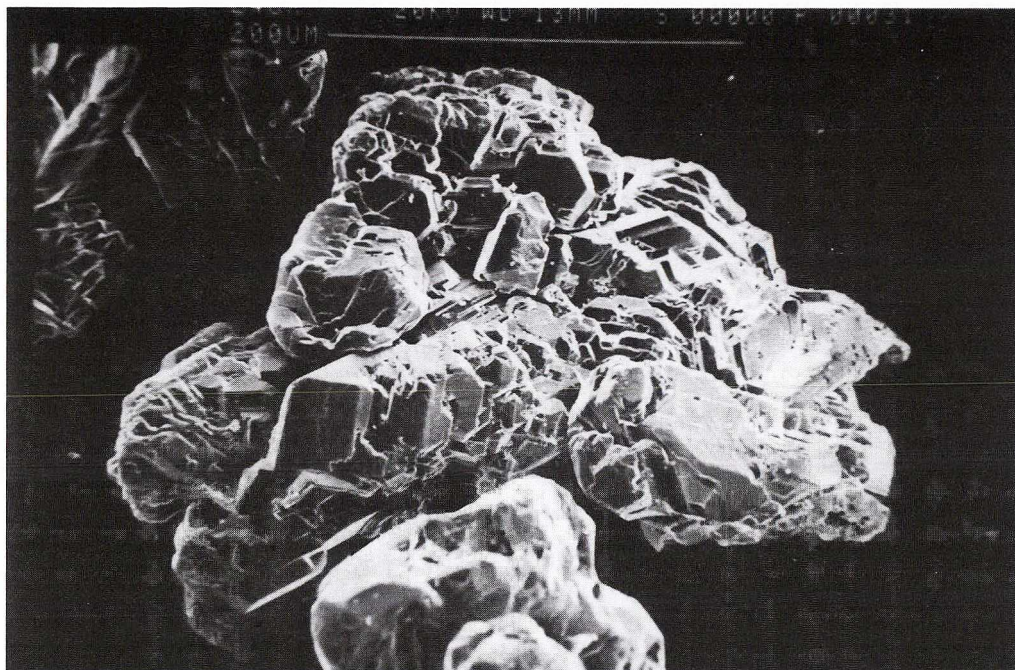

5C Electrolytic silver powder; $150\ \mu\text{m} < \Phi < 200\ \mu\text{m}$; P = 160×

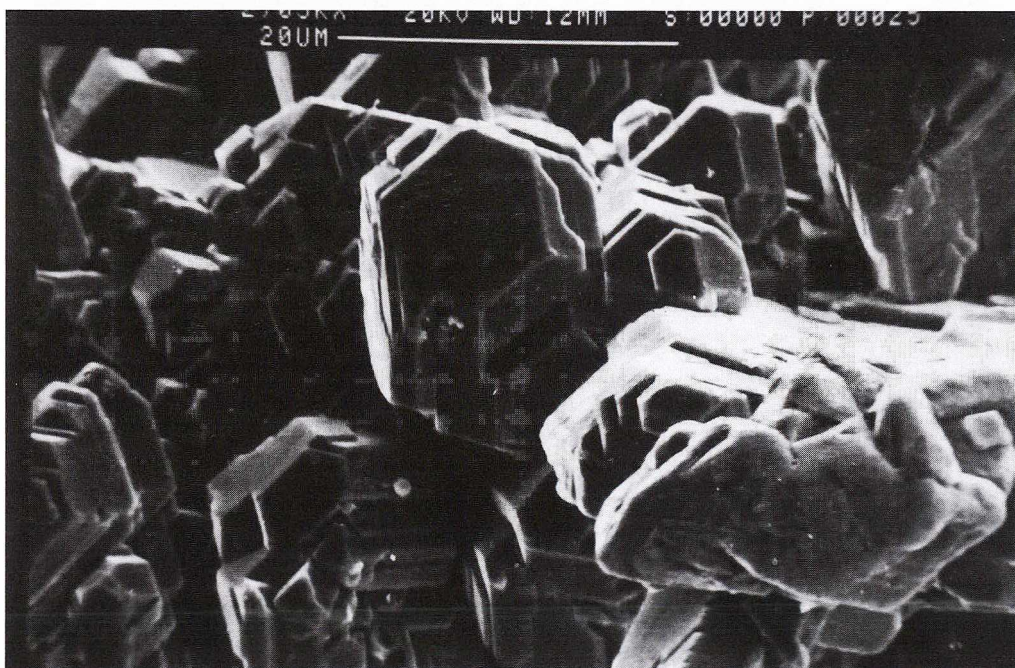

5D Electrolytic silver powder; $150\ \mu\text{m} < \Phi < 200\ \mu\text{m}$; P = 1400 ×

Fig. 5. Comparative list of the scanning analysis results of the initial silver powder, grain diameters: $150\ \mu\text{m} < \Phi < 200\ \mu\text{m}$, deposited electrolytically from a solution $0.2\ \text{m}\ \text{Ag}^+$, $0.5\ \text{m}\ \text{NaNO}_3$ and $0.08\ \text{m}\ \text{HNO}_3$, current intensity: $0.2\ \text{A}$, magnetic stirrer

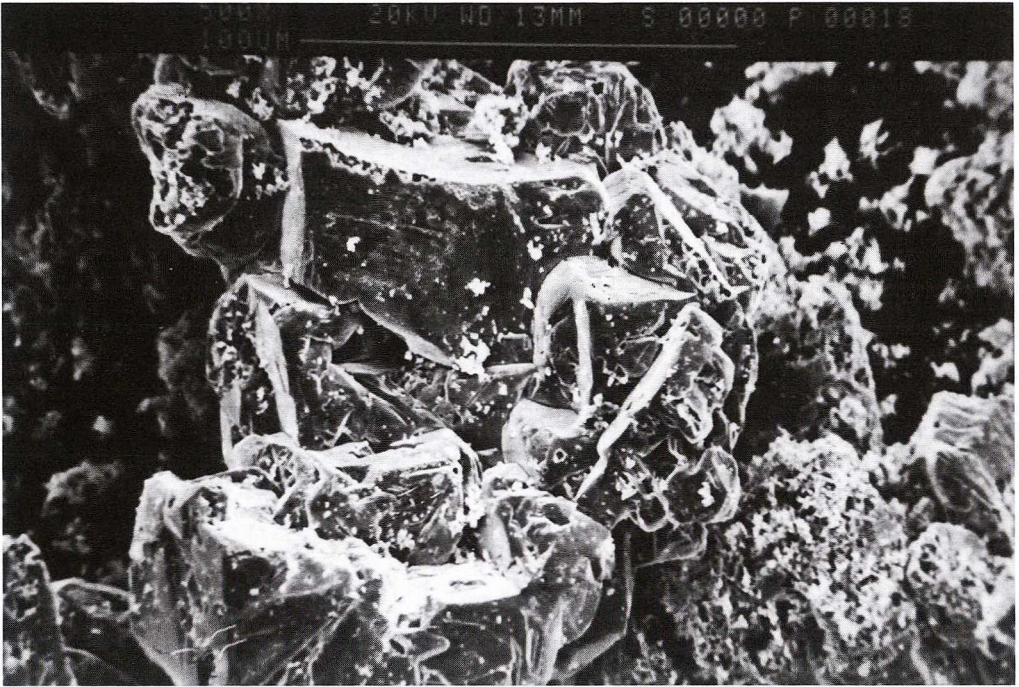

6A Electrolytic powder after anodic dissolution P=500 ×

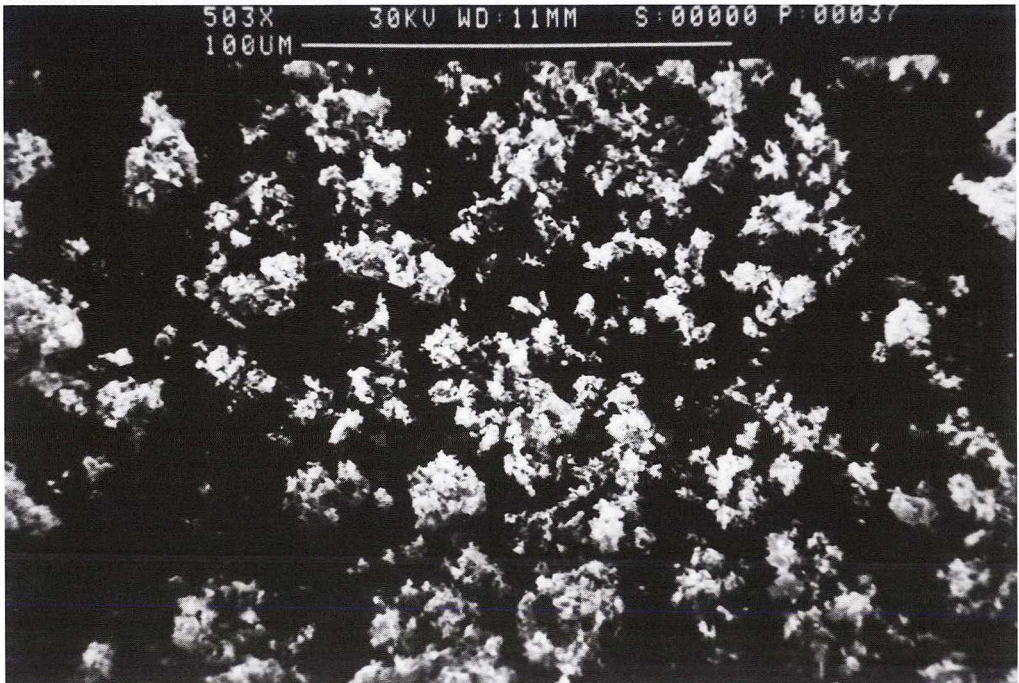

6B Electrolytic powder after dissolution (small fractions) P = 500 ×

Fig. 6. Appearance after anodic dissolution of electrolytic powder, initial diameter: $150 \mu\text{m} < \Phi < 200 \mu\text{m}$

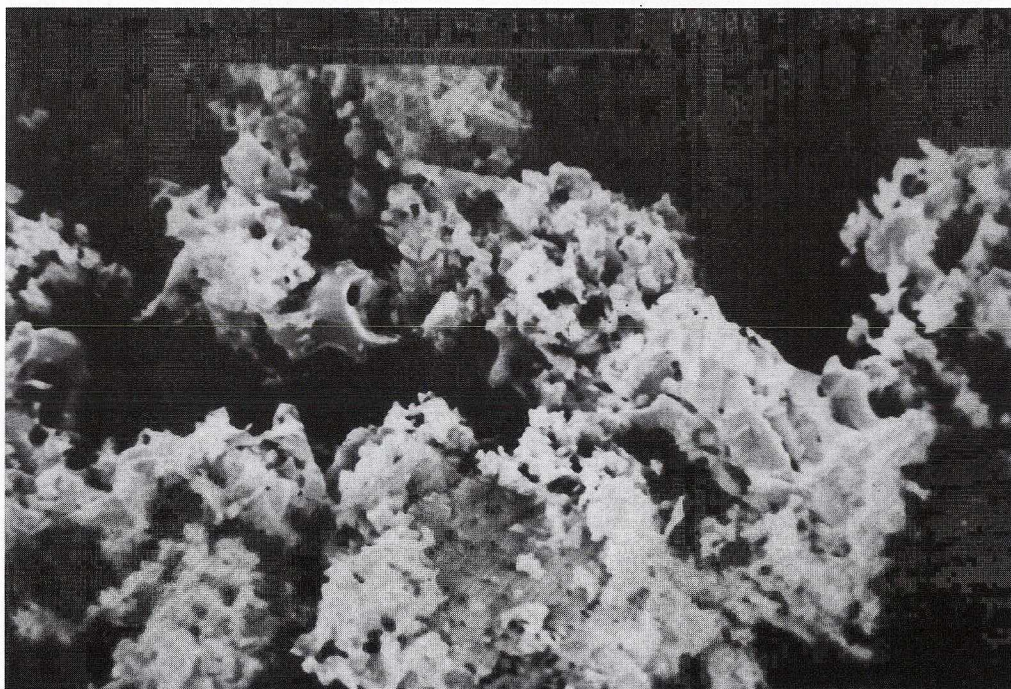

6C Electrolytic powder after anodic dissolution (small fractions) $P = 4000 \times$

Fig. 6. Appearance after anodic dissolution of electrolytic powder, initial diameter: $150 \mu\text{m} < \Phi < 200 \mu\text{m}$

As this powder is quite diversified in grain sizes, both fine and coarse grains are shown at the same magnification; while, fine grains are presented at a magnification eight times as big.

Distinct etching traces inside the grain are visible on quite large crystals preserved after dissolution. Fine grains, having irregular shapes and diameters of approx. $5 \mu\text{m}$, prevail.

Successive pictures (7A and 7B) show the electrolytic powder (initial diameter $0 < \Phi < 99 \mu\text{m}$) after anodic dissolution conducted under the same conditions as in the case of the powder with diameters $150 \mu\text{m} < \Phi < 200 \mu\text{m}$, presented above.

A characteristic feature of the grains shown in Figs 7A and 7B is that they have preserved their polyhedral shape after anodic dissolution. Then, there appear also finer grains but their number is comparable to the number of grains whose diameter is slightly smaller than the initial. The process of dissolution of that grain grade is likely to have been occurring much more mildly than in the case of the coarser grains.

The appearance of grains whose initial diameters were as large as $750 < \Phi < 1000 \mu\text{m}$ is presented after the anodic dissolution. A comparison of grains of powders obtained in the cathodic reduction of AgCl and electrolytically was performed for that grade as well.

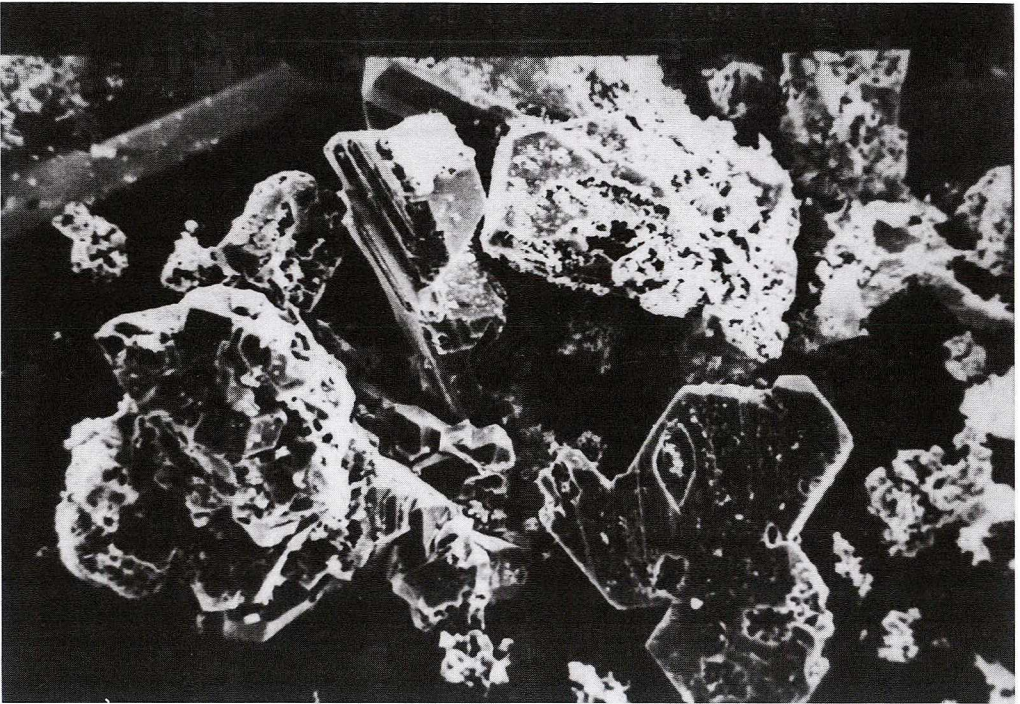

7A Electrolytic powder after anodic dissolution; P = 250 ×

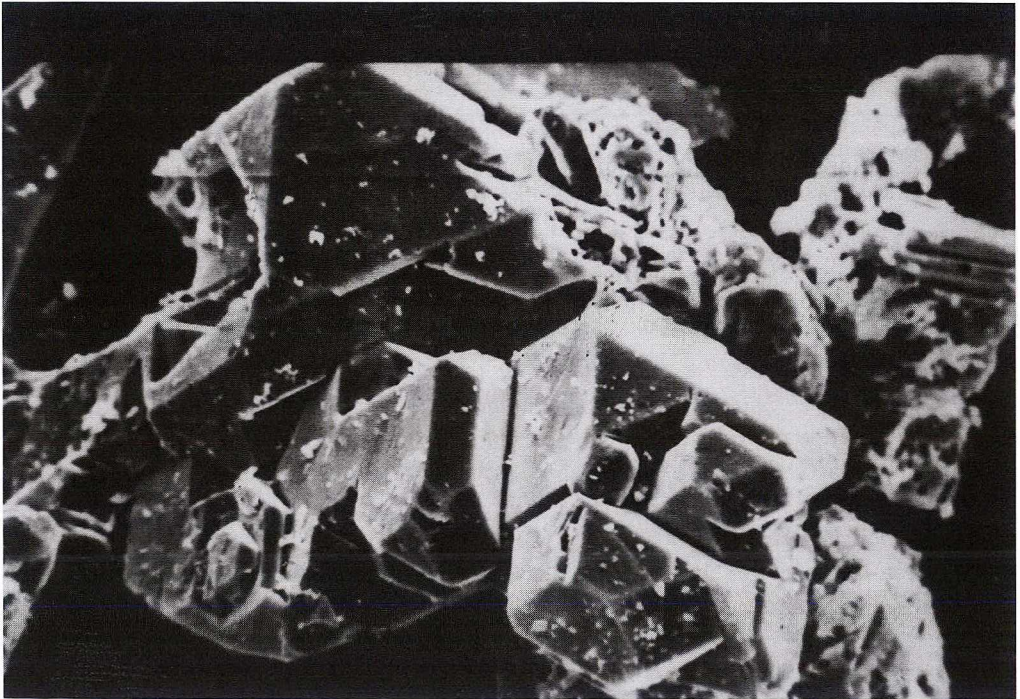

7B Electrolytic powder after anodic dissolution; P = 1000 ×

Fig. 7. Appearance after anodic dissolution of electrolytic powder, initial diameter, initial diameter $0 < \Phi < 99 \mu\text{m}$

An examination of the pictures, shown in Fig 8, confirms previous observations that the larger the grains, the longer the process of anodic dissolution runs.

As far as the powder obtained in the cathodic reduction of AgCl is concerned, the conglomerates produced consist of very fine grains. In Picture 8A, taken at a magnification of 50x, one can see that grains having the initial shape are still present after the process of anodic dissolution. Instead, in Fig 8B [magnification 5000 ×] it can be noticed that the etching process takes place on the surface of those fine grains, bringing about no damages.

The pictures of the powder produced electrolytically [Fig 8C] indicate a very intensive dissolution process. Apart from a frame of larger particles, there is an appreciable number of finer grains resembling bread crumbs. Increasing the magnification 2.5 times [Fig 8D], there is a visible clear-cut open-work construction of left-over grains as compact as before the anodic dissolution.

Summing up the results of the observations of the powder morphology, performed on a scanning microscope, it can be noticed that the experiments indicate quite a different effect than that stemming from the common belief that anodic dissolution of smaller grains occurs faster because of a higher current density.

This result complies with the assumed hypothesis that the powder passivation results from the penetration of the solution through the powder layer to the graphite surface. In the case of a fine-grained powder of a lower bulk density (1.66 g/cm^3), the solution will contact the graphite surface earlier than in the case of a compact electrolytic powder [bulk density 2.14 g/cm^3]. Consequently, the dissolution of compact grains of larger diameters takes more time.

Systematic investigations of the relation between the fraction reacted and the grain diameters for two types of silver powder were carried out. The results of those investigations are shown in Fig 9. The grain diameter was calculated as an average value of the lower and upper interval limits. For comparative purposes, this figure presents also an analogous relation found in the course of anodic dissolution of a compact silver plate, placed upon the graphite surface in the same system [the plate covered the entire graphite surface].

An analysis of the graphs presented in Fig 9 allows to draw the following conclusions:

1. The fraction reacted depends on the silver granulation grade. For solid metal, the fraction reacted amounts to 97.1 [%], current efficiency being 99.9 [%]. Practically, all silver has been dissolved.

The silver powder obtained electrolytically, with compact grains, has a lower fraction reacted than solid metal plates, however, this value is higher than that obtained for silver powder in the cathodic reduction of AgCl, whose grains constitute a conglomerate of very fine particles. In both cases, the current intensity amounts to 100%.

2. The relations presented in Fig. 9 can be written down as the following empirical formulae:

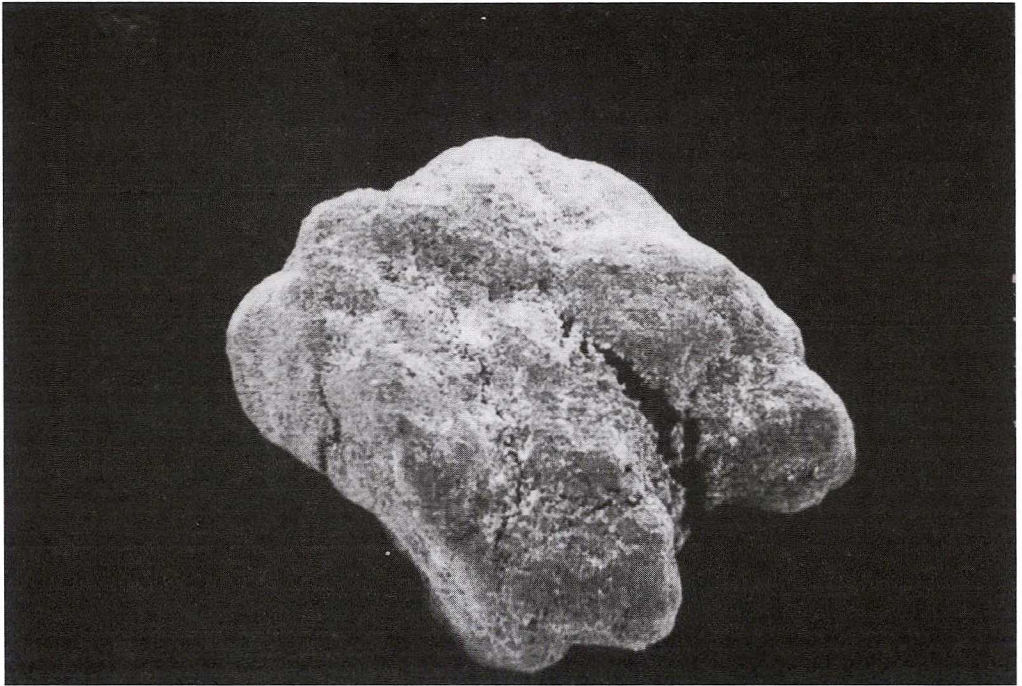

8A Powder obtained from cathodic reduction of AgCl; P = 50 ×

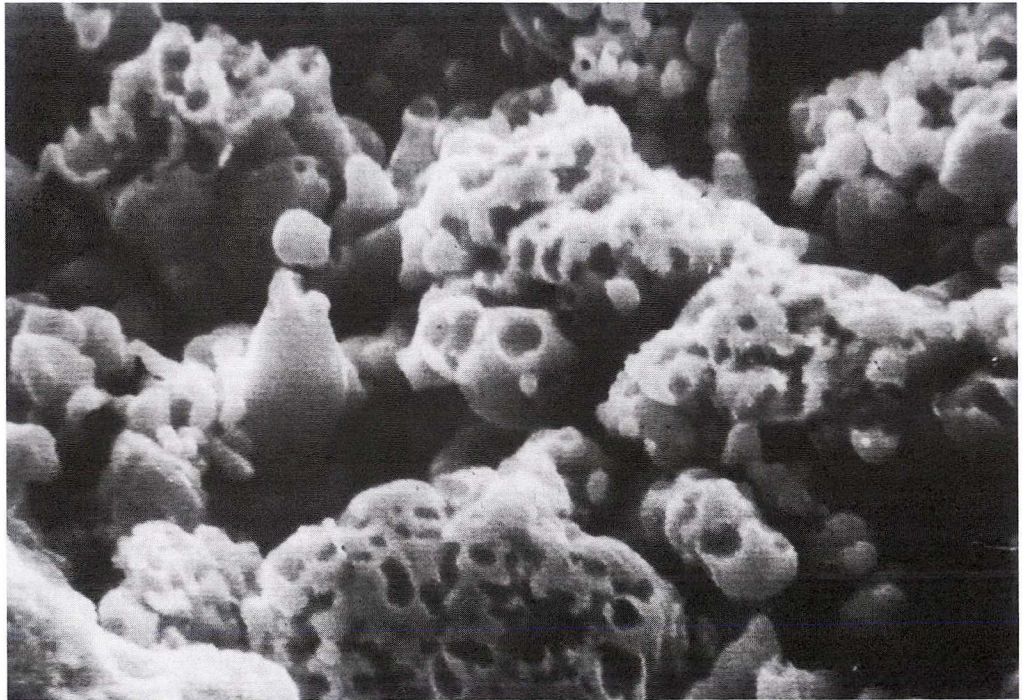

8B Powder obtained from cathodic reduction of AgCl; P = 5000 ×

Fig. 8. Appearance of powders after anodic dissolution. Initial diameters: $750 < \phi < 1000 \mu\text{m}$

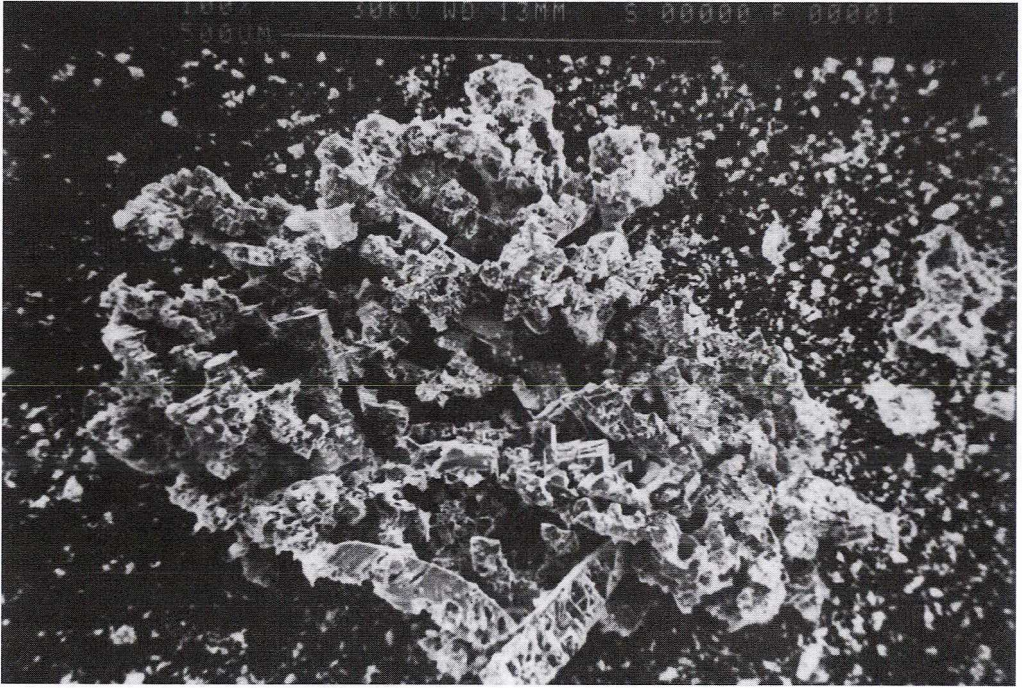

8C Powder obtained electrolytically; P = 100 ×

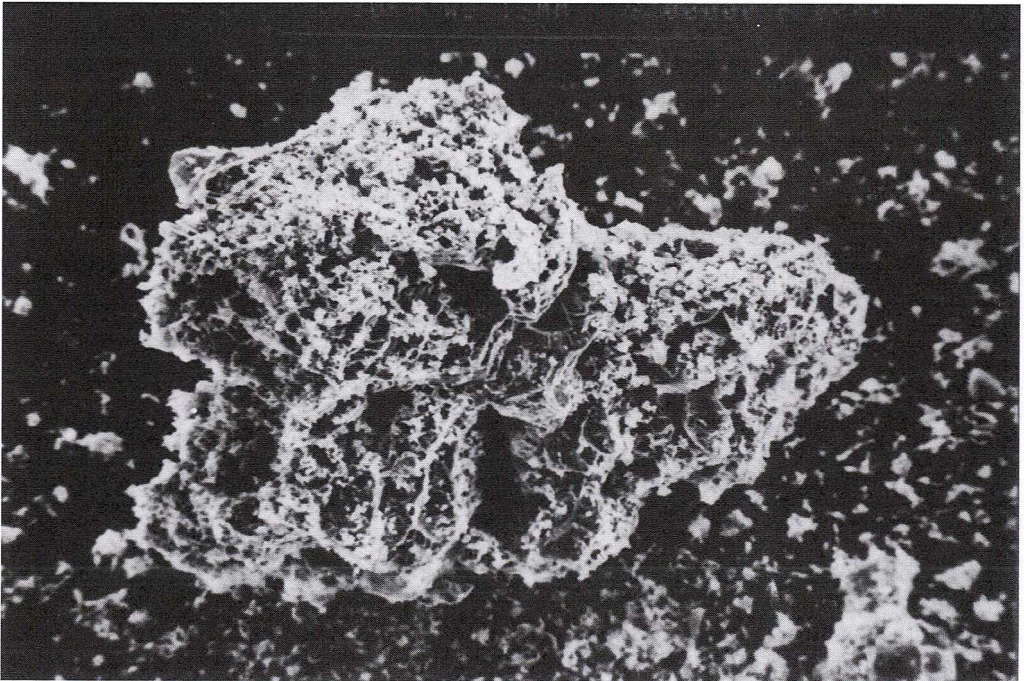

8D Powder obtained electrolytically; P = 250 ×

Fig. 8. Appearance of powders after anodic dissolution. Initial diameters: $750 < \Phi < 1000 \mu\text{m}$

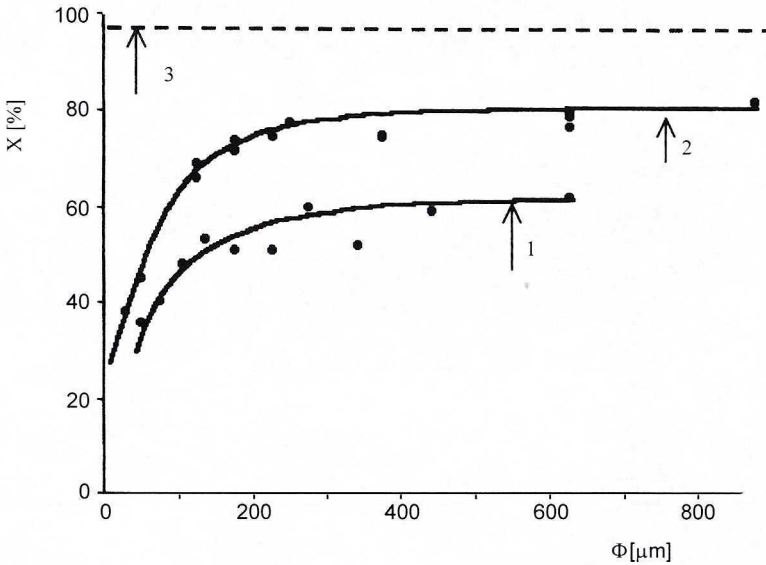

Fig. 9. Effect of grain structure of silver powder upon the fraction reacted in the process of anodic dissolution
 Curve 1 presents relation $X = f(\Phi)$ for silver powder obtained through cathodic reduction of AgCl
 Curve 2 regards silver powder obtained electrolytically from nitrate solutions. The fraction reacted for anodic dissolution of the silver plate is marked with a dashed line

- For the silver obtained in the cathodic reduction of AgCl, the relation between the fraction reacted X and conglomerate diameter Φ is as follows:

$$X = a + \frac{b}{\ln \Phi}, \quad (5)$$

correlation coefficient $r^2 = 0.8341$

coefficients "a" and "b" are, respectively:

$$a = (0.85 \pm 0.04) \quad b = -(1.7 \pm 0.2)$$

Assuming $X \rightarrow 0$ when $\Phi \rightarrow \Phi_o$, we can find the minimum diameter of grains [conglomerate] at which the anodic reaction is possible

$$-\frac{a}{b} = \frac{1}{\ln \Phi_o} = 0.5 \Rightarrow \ln \Phi_o = 2. \quad (6)$$

This means that in the case under consideration, the process of anodic dissolution is possible when the minimum grain diameter Φ_o exceeds $7.4 \mu\text{m}$. Applying the empirically determined values of "a" and "b" coefficients, equation (6) can be put down in the following form:

$$X = a \left(\frac{\ln \Phi - \ln \Phi_o}{\ln \Phi} \right) = 0.85 \left(\frac{\ln \Phi - 2}{\ln \Phi} \right). \quad (6a)$$

•• As far as the anodic dissolution of electrolytic silver powder is concerned, the relation between the fraction reacted and the grain diameter can be put down with an equation:

$$X = a + \frac{b}{\Phi}, \quad (7)$$

for a correlation coefficient $r^2 = 0.9597$

and the values of coefficients 'a' and 'b' are, respectively:

$$a = (0.83 \pm 0.01) \quad b = -(21 \pm 1).$$

Examining equation (7) in a way similar to that performed for equation (5), we find that the fraction reacted is 0, when $\Phi_o = -\frac{b}{a} = \frac{21}{0.83} = 25 \mu\text{m}$.

Equation (7) can be also presented in a simplified form:

$$X = 0.83 \left(\frac{\Phi - \Phi_o}{\Phi} \right) = 0.83 \left(\frac{\Phi - 25}{\Phi} \right). \quad (7a)$$

By setting expressions (6a) and (7a) into Formulae 4b–4f, we arrive at generalised kinetic equations combining the passivation time with the electrolysis parameters, through which the process of anodic dissolution of polycrystalline electrodes can be controlled.

For the silver powder obtained in the cathodic reduction of AgCl, the equation can be written down as follows:

$$t_p = \frac{m_o}{ki} X = \frac{m_o}{ki} 0.85 \left(\frac{\ln \Phi - 2}{\ln \Phi} \right). \quad (8)$$

Analogously, we can express the time of anodic dissolution for the electrolytic silver powder as follows:

$$t_p = \frac{m_o}{ki} X = \frac{m_o}{ki} 0.83 \left(\frac{\Phi - 25}{\Phi} \right). \quad (9)$$

Fig. 10 shows a comparison of the calculated curves with equations (8) and (9) and the experimental values. In both cases a good agreement is found.

If Equations (8) and (9) are multiplied by sides by the product of the electrochemical equivalent and current intensity, we get the formulae for the maximum mass of silver powder which can be passed into the solution through anodic dissolution until passivation occurs:

$$m_{rozp} = 0.85 m_o \left(\frac{\ln \Phi - 2}{\ln \Phi} \right) \quad (10)$$

and for the electrolytic silver powder:

$$m_{rozp} = 0.83 m_o \left(\frac{\Phi - 25}{\Phi} \right). \quad (11)$$

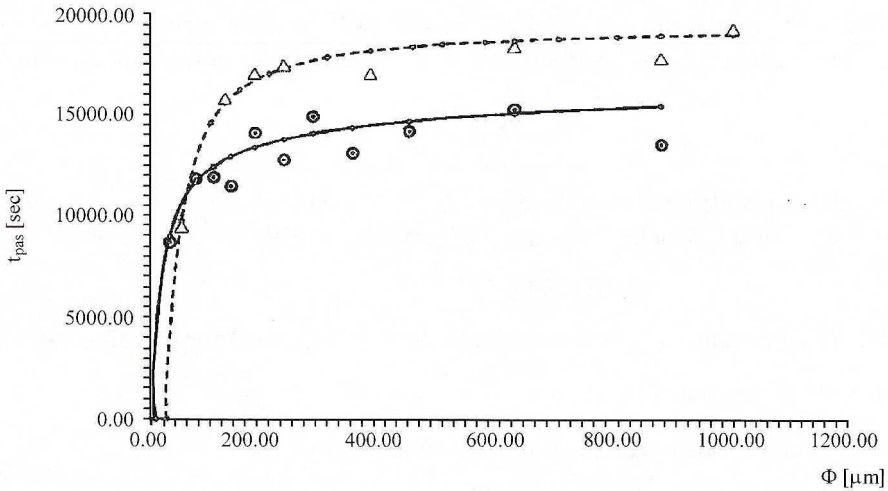

Fig. 10. List of relationships between passivation times and grain diameters, depicted with curves determined basing upon empirical equations (8) i (9), with the values found in direct measurements
 Continuous line and symbol \circ – regard the measurements performed with silver obtained from cathodic reduction of AgCl
 Dashed line and symbol Δ – stand for measurements performed with electrolytic silver

According to Formulae (10) and (11), one may conclude that if a layer of fresh, dry silver powder is placed on the passivated one, the process of anodic dissolution can be continued by recovering a successive portion of silver (taking into consideration the experimental result, presented before, proving that a powder layer is still electrically conducting after a jump change in the potential value has occurred). Such experiments have been performed and their results are shown both in Fig 11 and in Table 1. An

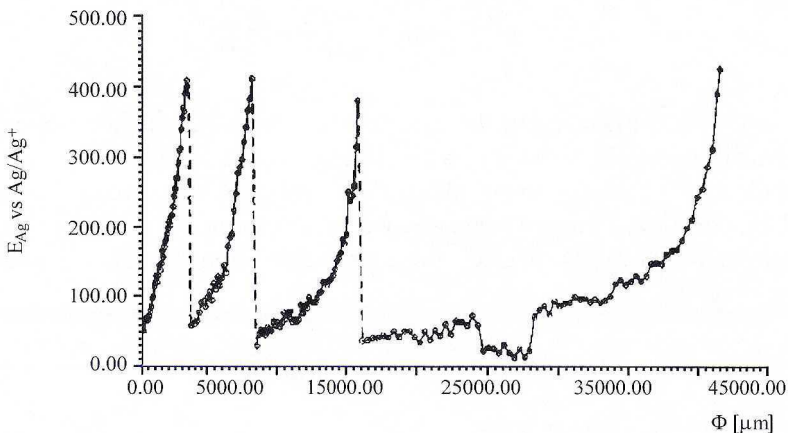

Fig. 11. Galvanostatic curves of anodic dissolution of silver powder. The process was being held with a gradual laying of fresh powder coatings upon reaching the passivation potential value

TABLE I

Relation between the fraction reacted and passivation time vs the weighed portions of silver powder, successively added

Nr	$m_{i.o}$	$m_{i.rozp}$	$m_{i.poz}$	$\Sigma m_{i.poz}$	t_p	X_i
	[g]	[g]	[g]	[g]	[sek]	%]
1	2	3	4	5	6	7
1	2.4828	0.4998	1.9830	1.9830	2168	20.13
2	2.4878	0.8653	1.6225	3.6055	3756	34.78
3	2.5154	0.2822	2.2332	5.8687	1162	11.22
4	6.8314	2.6932	4.1382	9.9769	11888	39.42
Σ	14.317	4.3405			18974	30.32
1	4.4872	0.7762	3.7110	3.7110	3253	17.00
2	4.4779	1.0734	3.4045	7.1155	4570	23.97
3	7.2811	1.7626	5.5185	12.6340	7822	24.21
4	12.5090	5.1899	7.3191	19.9530	23195	41.49
Σ	28.756	8.8021			38840	31.00
1	5.7578	1.6199	4.1379	4.1379	6970	28.13
2	5.7578	2.4610	3.2968	7.4347	10688	42.74
3	5.7679	1.6116	4.1563	11.5910	7195	27.94
Σ	17.284	5.6925			24853	32.93
150 $\mu\text{m} < \phi < 200 \mu\text{m}$						
1	5.7922	3.7653	2.0270	2.0270	16651	65.01
2	2.9970	1.6004	1.3970	3.4240	6738	53.40
1	2.9957	1.9466	1.0490	1.0490	8364	64.98
2	2.9976	2.9329	0.0650	1.1140	13089	97.84

analysis of the graphs presented allows to conclude that when a passivated powder layer is overlaid with a fresh powder portion, not only the potential comes back to its initial value, but the reacted fraction of the successive powder portion is higher than during the dissolution of the first one. The condition for increasing the fraction reacted is that the mass of fresh powder, laid as successive layer, should be higher than the total mass of the powder remaining after a jump change in the potential value has occurred. This regularity is likely to be connected with the average grain size at the given moment. The data collected in the table imply that the relation mentioned is satisfied for both a very fine powder, for which the first fraction reacted amounted to a dozen or so per cent and

after a few grades the overall amount X exceeded 30%, and for coarser powders, with initial value $X \sim 65\%$ rising to $\sim 98\%$ for the second grade.

The measurements aimed at finding a relation between the fraction reacted and the time for which a powder electrode remains in contact with the solutoins, are also worth mentioning. The result of such an experiment is shown as example in Fig 12. Curve 1 shows a galvanostatic measurement in which the current was applied immediately upon pouring the electrolyte. Curve 2 presents a relation between the anode potential and the dissolution time of the powder remaining in contact with the solution for 4 hours before the current is applied. While analysing the courses of those graphs, it can be noticed that a jump change in the potential value takes place appreciably earlier in the case of the powder remaining in contact with the electrolyte for a longer time before the electrolysis starts than in the case when the current is applied immediately upon rigging the measuring system.

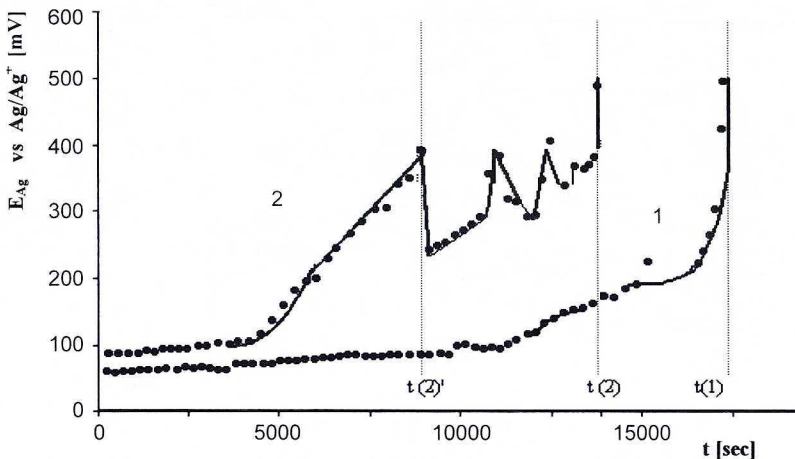

Fig. 12. Effect of the time of silver powder wetting for the passivation period during anodic dissolution
Graph 1 – galvanostatic curve found in a measurement in which the current was applied on immediately after the system has been assembled
Graph 2 – shows a relation between the anode potential and the time of dissolution of powder remaining in the solution for a 4 hours' time before the current is applied

The reason for the existence of the extremes, observed on curve 2, is that the inflow of the solution to each point of the graphite surface is irregular. Therefore, the anode surface is not equipotential. It was proved while shifting slightly a L u g i n ' s capillary tube. The experiments described above are likely to corroborate the initial hypothesis that the reason for a jump change in the potential value is the inflow of the electrolyte to the graphite surface, and this allows the anodic reaction to proceed in compliance with equation (2).

Nevertheless, there is a question about the behaviour of the silver powder when the reactive surface shifts to the interface graphite-electrolyte. In order to find an answer to

this question, an electrolyser was used in which some metal plates, not connected to a power source, were introduced between the cathode and the anode. This is a system of bipolar electrodes on which the rate of cathodic reduction of Ag^+ ions on one side of the plate is equal to the rate of anodic dissolution on the other side. Hence a zero mass balance in the processes occurring on the metal plates suspended between the cathode and the anode is obeyed.

By assuming that the layer of the metal powder, whose inter-grain spaces are filled with solution, can be considered as a group of bipolar electrodes, it can be expected that this layer will not be actually subject to dissolution. Hypothetically, the process of anodic dissolution of a metal powder can be presented as follows:

- At the first stage, it occurs on the interface between the dry powder surface and the electrolyte.

- As the reaction goes on and as the solution keeps on filling inter-grain spaces, the reactive surface shifts towards graphite. The layer of the dry powder still behaves as a solid metal through which electrons flow between the substrate surface and the reactive layer; instead, the solution-filled powder between the reactive surface and the electrolyte solution does not participate effectively in the process of dissolution.

- When the electrolyte has reached the graphite surface and a very thin film has come to exist between the powder and the substrate, the process of effective silver dissolution stops all over the silver powder layer. Oxygen evolution will be the anodic reaction, and this will be accompanied with a jump change in the potential value.

To verify this assumption some experiments were performed in which the silver powder was placed not directly on the graphite, but on a silver plate adjoining the graphite. In comparison, in a subsequent experiment, silver powder of identical weight was placed directly on the graphite; other experimental conditions were preserved. Examples of the experimental results are shown in Fig 13 and in Table 2.

Curve 1 shows the process of anodic dissolution of the silver powder placed on the graphite. It points to the fact that after the time of about ~ 18000 seconds a sudden rise in the potential up to the value of more than 400 mV vs. Ag/Ag^+ , which means that the anode becomes the oxygen electrode because the silver powder dissolution stops. It can be seen from Table 2 that this corresponds to the fact that 75% of the initial silver powder mass was reacted.

Curve 2 describes the route of the anodic process with the use of silver powder of the same mass but placed on a silver plate. In this case the potential stays on a constant level corresponding with the silver dissolution, even after the time of 24000 seconds is exceeded. The weight analysis performed after the electrolysis was completed showed that in this case also 75% of the initial silver powder mass was reacted, followed by the dissolution of the silver plate itself. (The results are presented in Table 2).

The fact that in both cases the same amount of the silver powder was reacted shows that the reason for the discontinuance in the silver powder dissolution are not the changes in the electrolyte, especially the saturation of the electrolyte with the Ag^+ ions

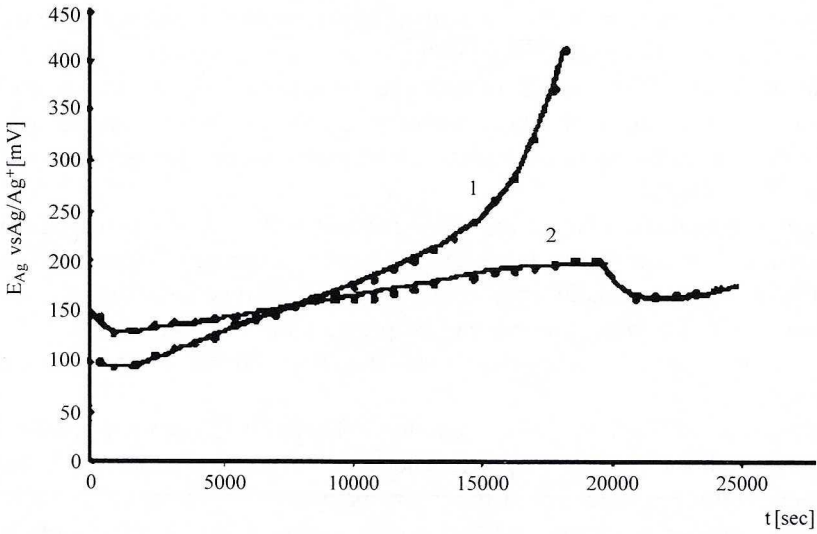

Fig. 13. Variation in the anode potential during the dissolution of silver powder laid on:
 1. a graphite substrate
 2. a silver substrate

TABLE 2

List of measurement results for fraction reacted of silver powder, diameter: $250 \mu\text{m} < \Phi < 500 \mu\text{m}$:

- 1] when the powder touched graphite
 2] when the powder touched a silver plate arranged on the graphite

$m_o \text{ powder}$ [g]	$m_o \text{ plate}$ [g]	$(m_{\text{rozp}})_{\text{powder}}$ [g]	$(m_{\text{rozp}})_{\text{plate}}$ [g]	X_{powder} [%]
5.3903		4,0278		74,7
5,3999		4,0159		74,4
5.3864	4.8709	4.2106	1.3329	78.2
5.3956	4.3233	3.9030	0.5653	72.3

does not take place (the dissolution of the silver plate being a proof here) but this discontinuance is connected with the reaching of the substrate by the electrolyte penetrating through the powder. Therefore, when the electrolyte reaches the solid surface of the substrate, the effective dissolution of silver powder falls to zero, since the silver powder is from that moment on a system of bipolar electrodes.

Summing up the results of this experiment, it can be concluded that the time of anodic dissolution of silver powder $-t_p$ is equal to the time after which the electrolyte reaches the interface: silver powder – current supplying substrate. The occurrence of

even a thinnest film of electrolyte solution causes the flow of electrons from the graphite substrate to the metal powder to take place as a result of the reaction of that electrolyte with graphite. Electrons cannot 'leap over' from the graphite to the silver.

The passivation time is thus not controlled by the type of the reaction occurring at the interface of the substrate made of a solid conductor, but by the separation of dry silver powder from the substrate caused by a 'leaking' electrolyte solution. However, taking into consideration the fact that the solution penetration through the powder layer is relatively slow, it can be stated that in an electrolytic process it is possible to recover about 60 to 80% of silver. This process can be controlled by pressing or increasing the powder grain size.

The degree of silver recovery may be also considerably increased by overlaying successive layers of fresh powder layers without interrupting the electrolysis. A layer of a fresh dry powder has a potential more electronegative than passivated powder; consequently, oxygen evolution stops. As a result, on the surface of a more electronegative silver powder, the deposition of silver powder will start on one side of the grains while the dissolution takes place on the other. However, in this case, the mass balance is positive.

The silver powder left upon the completion of the electrolysis is washed, filtered off, dried and can be re-used in a successive stage of the electrolysis.

4. Summary

In the absence of a complete and experimentally verified description of the anodic process of dissolution of polycrystalline electrodes, which could be applied for working out the problem of the recovery of metals from intermediate products of metallurgical industry, systematic investigations on the kinetics and the mechanism of the anodic dissolution of this type of electrodes were carried out, taking as example silver powder. The anode was silver powder placed on a graphite substrate immersed in a nitrate electrolyte. The investigations were carried out with the galvanostatic method supplemented with gravimetric and coulometric measurements. Also observations of the powder on a scanning microscope before and after the measurement were performed.

Taking into account the results of this study the following facts have been stated:

1. Initially, the process of anodic dissolution of silver powder occurs at overvoltages less than 60 mV.
2. During the anodic dissolution, the silver powder is subject to passivation resulting from a separation of the powder from the power supply substrate due to the formation of a thin film of the electrolytic solution.
3. The time of passivation depends on the sample mass, current intensity, but does not depend on either silver ion concentration in the electrolyte solution or on the solution mixing. The silver powder structure and the powder wetting time are the factors that affect the passivation time, and consequently, the fraction reacted in the anodic process most.

4. When the solution reaches the power supply substrate, the process of silver powder dissolution is inhibited independently of the process occurring on the solid part of the anode (whether evolution of gaseous oxygen or dissolution of the substrate itself). It was assumed that the silver powder behaves like a group of bipolar electrodes.

5. It was proved that the reacted fraction of the silver powder might be appreciably elevated by having the metal powder granulated and by conducting the dissolution process in several stages, viz. by overlaying passivated layers with fresh, dry powder. An overlaid layer of a fresh, dry powder is more electronegative in comparison to the powder left after anodic dissolution as soon as a jump change in the potential value [passivation] takes place. Consequently, the initial potential value of silver is restored and anodic dissolution takes place again. The time of dissolution till the successive passivation event depends upon the ratio of the mass of the newly placed powder layer to the mass of the powder left upon passivation.

6. There have been derived some empirical equations allowing to control the process of anodic dissolution. It can be calculated that in granulated slimes, the fraction reacted exceeds 60%. In case of a several-stage process [viz. when overlaying with layers of fresh powders], it may exceed 98%. It should also be mentioned that the powder passivation is not durable, so after the powder is filtered off and dried, it can be dissolved in a successive electrolytic process.

7. It has been proved that the most significant feature, differing polycrystalline anodes from those made of solid metal, is that the metal powder must be connected to the power supply in the electrolyte bulk through a substrate made of solid conductor. Hence, the process of bringing electrons to and from the reactive surface is the decisive stage in the case of powder electrodes. It may be entirely neglected in the case of solid metal electrodes because it is rapid and has no effect on the kinetics and the mechanism of the process.

The results obtained seem to justify further investigations on the recovery of metals from slimes by means of direct electrolysis. Further measurements on anodes consisting of a mixture of silver powder with lead sulphate, and of silver and copper powders are scheduled. And then the examination of the properties of respective products of the electrolytical restoring of anodic slimes, these products aggregating on the cathode in the form of a metal strip.

REFERENCES

- [1] Z. Zembura, W. Głodzińska, I. Harańczyk, Sposób otrzymywania proszków metali; Patent Nr 87839, 1977
- [2] I. Harańczyk, Anodowe roztwarzanie proszków metali jako metoda odzysku pierwiastków z odpadów i półproduktów przemysłu metalurgicznego; II KRAJOWA KONFERENCJA NAUKOWA na temat TEORETYCZNE I PRAKTYCZNE PROBLEMY ZAGOSPODAROWANIA ODPADÓW HUTNICZYCH; 23–24. 09. 1999
- [3] J. Sędzimir, I. Harańczyk, Z. Bogacz, Sposób odzyskiwania srebra z odpadowych roztworów zawierających związku srebra, Patent Nr 269427, 1992.

- [4] *J. Sędzimir, I. Harańczyk*, Cathodic reduction of silver chloride, Proceedings of the Second Intern.Conf. on Hydrometallurgy, Changsha, China, October 23–26, 523–527, (1992).
- [5] *I. Harańczyk, J. Sędzimir*, Dependence of the current, in the cell Ag/AgCl, electrolyte/Al. or Zn. on the external and internal resistance and on the electrode reactions, Archives of Metallurgy **36, 2**, 185–200 (1991).
- [6] *I. Harańczyk, S. Gacek*, Odzysk srebra z odpadów, Fundacja Metale Nieżelazne, Materiały I Krajowej Konferencji Naukowej pt. Teoretyczne i Praktyczne Problemy Zagospodarowania Odpadów Hutniczych, Niedzica, 8–9.10.1998.
- [7] *I. Harańczyk, S. Gacek*, Fundacja Metale Nieżelazne Tradycja i Rozwój, Materiały I Krajowej Konferencji „Metale Szlachetne”, Niedzica, 5–6.10.2000, p. 34–48, 2000.
- [8] *Pauline De Vidts, Ralph E. White*, Governing Equations for Transport in Porous Electrodes, J. Electrochem. Soc. **144, 4**, 1343–1353 (1997).
- [9] *A.M. Vidales, E. Miranda, M. Nazzarro, V. Mayagoitia, F.Rojas, G. Zgrablich*, Invasion percolation in correlated porous media, Europhys. Lett. **36, 4**, 259–264 (1996).
- [10] *Ju.W. Sałytkow, W.L. Kornienko*, Primienieniye Teorii Fraktalów dla Opisania Poristych Elektrodow. Efektywnyije Koefficienty w Modeli Cylindriczeskich Por, Elektrochimija **32, 10**, 12267–1269 (1996).
- [11] *H.J. Keh, Wen J. Li*, A Study of Bipolar Spheroids in an Electrolytic Cell, J. Electrochem. Soc. **144, 4**, 1323–1331 (1997).
- [12] *G. Zheng, B.N. Popov, R.E. White*, Application of Porous Electrode Theory on Metal Hydride Electrodes in Alkaline Solution, J. Electrochem. Soc. **143, 2**, 435–441 (1996).
- [13] *L.G. Austin, H. Lerner*, The Mode Operation Of Porous Diffusion Electrodes – I. Simple Redox System, Electrochimica Acta **9**, 1469–1481 (1964).
- [14] *L.G. Austin*, Tafel Slopes for Flooded Diffusion Electrodes, Trans. Faraday Soc. **60**, 1319–1324 (1964).
- [15] *E.A. Grens, C.W. Tobias, L.G. Austin*, Note On “The Influence Of Electrode Reaction Kinetics On The Polarization Of Flooded Porous Electrodes”, Electrochimica Acta **14**, 639– 641 (1969).
- [16] *C.W. Tanner, Kuan-Zong Fung, A.V. Virkar*, The Effect of Porous Composite Electrode Structure on Solid Oxide Fuel Cell Performance, J. Electrochem. Soc. **144, 1**, 21–30 (1997).
- [17] *X. Ling, Z.H. Gu, T.Z. Fahidy*, Anode Slime Behaviour in a Laboratory – Scale Copper Electrowinning Process, The Canadian J. of Chem. Eng. **72**, 683–695 (1994).
- [18] *X. Ling, Z.H. Gu, T.Z. Fahidy*, Effect of operating conditions on anode passivation in the electrowinning of copper, J. of Appl. Electrochem. **24**, 1109–1115 (1994).

REVIEWED BY: KRZYSZTOF FITZNER

Received: 20 September 2002.