

JULIAN PARTYKA*

POWER CYCLE OF AN UNDERGROUND LOADER

PRZEBIEG ŻUŻYCIA MOCY PRZEZ PODZIEMNĄ ŁADOWARKĘ

A power cycle for a large underground loader is developed using experimental data. Power measurements are taken by directly hooking up a computer to the electronic control module of the engine and recording the torque and rpm while the loader is working under normal condition. A power cycle for the engine is then calculated correlating these two parameters.

Results showed that the average power requirement for the loader while tramping with an empty bucket was 155 kW. During the duration of this operation, the loader had an energy expenditure of 31 MJ. When mucking, the average power of the loader was 216 kW, while expending 18 MJ of energy. Tramping with a full bucket required the loader to expend 40.5 MJ with an average power output of 174 kW. For one complete cycle, the energy storage requirement of the power supply is 95 MJ, with an average power output of 174 kW and a peak power output of 216 kW.

Key words: LHD, power cycle, fuel cell, ventilation, modelling

Produkcja energii elektrycznej w chemicznych ogniwach paliwowych (fuel cells) jest procesem, w którym jedynymi ubocznymi produktami są woda i minimalna ilość energii cieplnej. Procesowi chemicznemu nie towarzyszy formowanie się szkodliwych gazów podobnych do tych, które wydzielane są w czasie procesu spalania paliwa w silnikach dieslowskich. Fakt ten sprawia, iż prowadzone są intensywne próby zastąpienia silnika spalinowego w niektórych podziemnych maszynach górniczych przez ogniwo chemiczne. Powszechnie uważa się, iż wyeliminowanie szkodliwych gazów spalinowych umożliwi efektywne przewietrzanie kopalń za pomocą mniejszej ilości powietrza, a zatem bardziej ekonomicznie. Prowadzone badania naukowe koncentrowane są na wyprodukowaniu ogniw chemicznych stosownych do zasilania średniej ładowności ładowarek podziemnych. Zakłada się, iż zdolności produkcyjne oraz manewrowość ładowarek wyposażonych w ogniwa paliwowe i silnik spalinowy są identyczne. Oczekuje się ponadto, iż ładowarki z ogniwem chemicznym będą bardziej ekonomiczne niż ładowarki o tej samej ładowności, lecz wyposażone w silnik spalinowy czy ogniwo galwaniczne (tabl. 1).

W artykule przedstawiono i przeanalizowano eksperymentalne dane pomierzone w czasie pracy dużej pojemności ładowarki, wyposażonej w silnik dieslowski (rys. 1), transportującej urobek w ko-

* LAURENTIAN UNIVERSITY, SCHOOL OF ENGINEERING, RAMSEY LAKE ROAD, SUDBURY, ONTARIO, CANADA, P3E 2C6

palni miedzi i niklu. Wyniki badań wykorzystane zostały do opisu cyklu zużycia mocy silnika i do obliczania pojemności energetycznej ogniwa chemicznego, niezbędnej do ukończenia pełnego cyklu pracy ładowarki. Dane dotyczące mocy rejestrowane były przez komputer podłączony bezpośrednio do elektronicznego modułu kontrolnego silnika. Moc użytkowa silnika obliczana jest na bazie momentu obrotowego i prędkości obrotowej, parametrów mierzonych podczas aktualnej pracy ładowarki. Typowy cykl ruchu ładowarki (rys. 2, 4, tabl. 2) wyróżnia etapy takie jak postój, ruch do przodu bez ładunku, ładowanie, powrót z ładunkiem i wyładowywanie. Elektroniczny moduł kontrolny umożliwił pomiar obciążenia mocy (rys. 7), obroty i moment obrotowy silnika (rys. 6) oraz zużycie paliwa (rys. 5). Przy kompletnym wykorzystaniu modułu silnika komputer rejestruje także parametry charakteryzujące ruch ładowarki, w tym prędkość, postój, ruch do przodu i ruch wsteczny.

Końcowe wyniki wskazują, iż ładowarka zużywała średnio 155 kW i 31 MJ podczas ruchu bez ładunku, 216 kW i 18 MJ podczas operacji ładowania, 174 kW i 40,5 MJ podczas ruchu z pełnym ładunkiem (tabl. 6). Kompletny cykl ładowarki wymaga zakumulowania 95 MJ energii, której średnie i maksymalne zużycia wynoszą odpowiednio 174 kW i 216 kW (tabl. 7).

Słowa kluczowe: podziemna ładowarka, cykl energetyczny, ogniwo chemiczne, wentylacja, symulacja komputerowa

1. Introduction

Technological advancements have continually improved the safety and the efficiency of current mining operations over the last 5 decades. Mine seismic systems and remote controlled mucking are two of such innovations responsible for these continual improvements in the mining industry. These and other advancements allow engineers not only to reach deeper into the earth and recover mineral deposits that at one time could never be mined safely, but also resulted in the ability to increase the efficiency of today's mining operations to levels required to sustain the industry.

With the introduction of large-scale mobile underground equipment, companies have realized vast improvements in mine productivity, while decreasing the numbers of workers required. Diesel engine, the electric motor or the battery driven motor currently powers this equipment. Although up to now, these power sources have undoubtedly been fundamental in establishing mining as a profitable enterprise, they need to be improved. These technologies are currently unable to both simultaneously provide acceptable worker environments while maintaining high vehicle productivity and mobility.

The diesel engine has long been considered the benchmark for underground vehicular power. Diesel powered equipment delivers high production rates and allows good flexibility, so that equipment can move freely throughout routes in the mine. However, the very engine itself is responsible for the production of noxious emissions in the underground air supply. Much work has been done to the diesel engine to minimize the poisonous exhaust. Scrubbers are installed on diesel engines that significantly reduce the harmful gases in exhaust; however, constant monitoring of air quality is still required when operating diesel-powered equipment. High quantities of ventilation are supplied to areas where diesel equipment operates in order to dilute the noxious gases in the workplaces. This ventilation cost is usually one of the highest operational costs of the

mine. In addition, the diesel engine exhibits poor torque characteristics when compared to an electric powered engine. These torque characteristics tend not to lend the diesel engine well to automation.

Electric powered vehicles, although environmentally friendly, are often restricted to the limitations of their electrical cords. Most often, electric LHDs are used in workplaces where ventilation capacity is restricted to minimal amounts. Ramp travel for electric powered LHDs is often a time consuming procedure as once the length of the electric cord reaches its capacity, the operator must unplug it and attach the end to another outlet. However, electric powered haul trucks have been used with success as shown by the Kiruna truck system.

Underground equipment using a battery as a primary power source, has been limited to small tram motors on rail lines. The battery has a high weight to power ratio and is currently not well-suited for large-scale underground equipment. Even for smaller applications, the battery requires long recharge times to reach full capacity.

Mining companies continually research new technological advancements. One technological innovation that promises to significantly improve the efficiency and safety of current mining operations is the fuel cell (Anon 2001, 2002; Document 2001; Miller 2000; Gaibler, Miller 1998; Moller, Lucks 2000; Story 2000). The fuel cell is considered as the ideal replacement power source for today's large underground mobile equipment. Fuel cell technology could provide high vehicle productivity and have negligible environmental impact. This technology is considered a fundamental component in the development concept of a personless mine. However, before a fuel cell can be implemented in a mining environment, the power cycle and the energy utilized by the power source it will replace must be examined. This information is needed to establish the capacity of the fuel cell or any other advanced power source.

TABLE 1

Comparison of a hydride bed/fuelcell powerplant to a battery power in a four-ton mine locomotive

TABLICA 1

Porównanie mocy ogniwa wodorowego i akumulatora 4-tonowego elektrowozu górniczego

Parameter	Battery	HB/FC Powerplant
Power, continuous	7.1 kW (net)	14 kW (gross)
Current, continuous	71 A	135 A
Voltage at continuous rating	101 V	104 V
Weight of components	1650 kg	<550 kg
Volume of components	520 L	<250 L
Energy capacity, electrical	43 kWh	48 kWh
Operating time	6 h (available)	8 h
Recharge time	8 h	1/2 h (expected)

Fuel cells exhibit characteristics which are of utmost importance in an underground mining environment. As a part of their electricity producing reaction, fuel cells produce only pure water and a small quantity of heat as by-products. This factor alone allows for a safer working environment, as noxious emissions can be nearly eliminated from equipment sources. By eliminating these gases, ventilation requirements can be cut considerably, lowering many of the electrical costs associated with supplying large quantities of air throughout workings. Productivity and flexibility promises to remain equal to that of similar diesel powered engines. For smaller locomotive applications, fuel cells are expected to outperform comparable battery powered alternatives as shown in Table 1, published by the Fuelcell Propulsion Institute (Gaibler, Miller 1998).

2. Power cycle

The considered power cycle is a simple plot of the power output of a Load Haul Dump loader (LHD) engine over a period of time. A typical power cycle illustrates a variation of the engine power output. Each interval in the plot describes a specific operation of the loader, while the length of the interval represents the duration of the operation. The peak power output and the total energy expenditure required for a typical operation during different processes of underground material handling would be determined from the plot. Such a plot is used as a design foundation of any advanced power source, as this source must supply the same power as the engine it replaces. For the design purposes, the integral of this function defines the energy storage requirements of the designed power source, while the division of this integral is the average power or the minimum power necessary of the prime mover of a hybrid vehicle.

Equipment manufacturers do generally not develop the power cycle, and virtually no experimental data exists. For an accurate power cycle to be developed, experimental measurements are required. Therefore, it is the goal of this paper to accurately develop a power cycle for a large underground LHD. The two required components to calculate a power cycle are engine shaft power and time. Once recorded, the average power output and duration of each vehicle operation are correlated together to produce a power cycle.

3. Measurements

The vehicle chosen as the test vehicle for the project was a Wagner ST-8B LHD with a Detroit Diesel 215kW DDEC (Detroit Diesel Electronic Control) engine (Fig. 1) (Document 2002). This scoop has been modified by the mining company from its original design as a part of their tele-remote automation projects. The LHD is capable of being remote controlled from surface and can be fully automated when tramming. Information from the scoop is sent directly to the operator via a series of display monitors and control panels. The remote operator has the full function of all the controls and much of the information they receive is stored on a computer database. In our case,

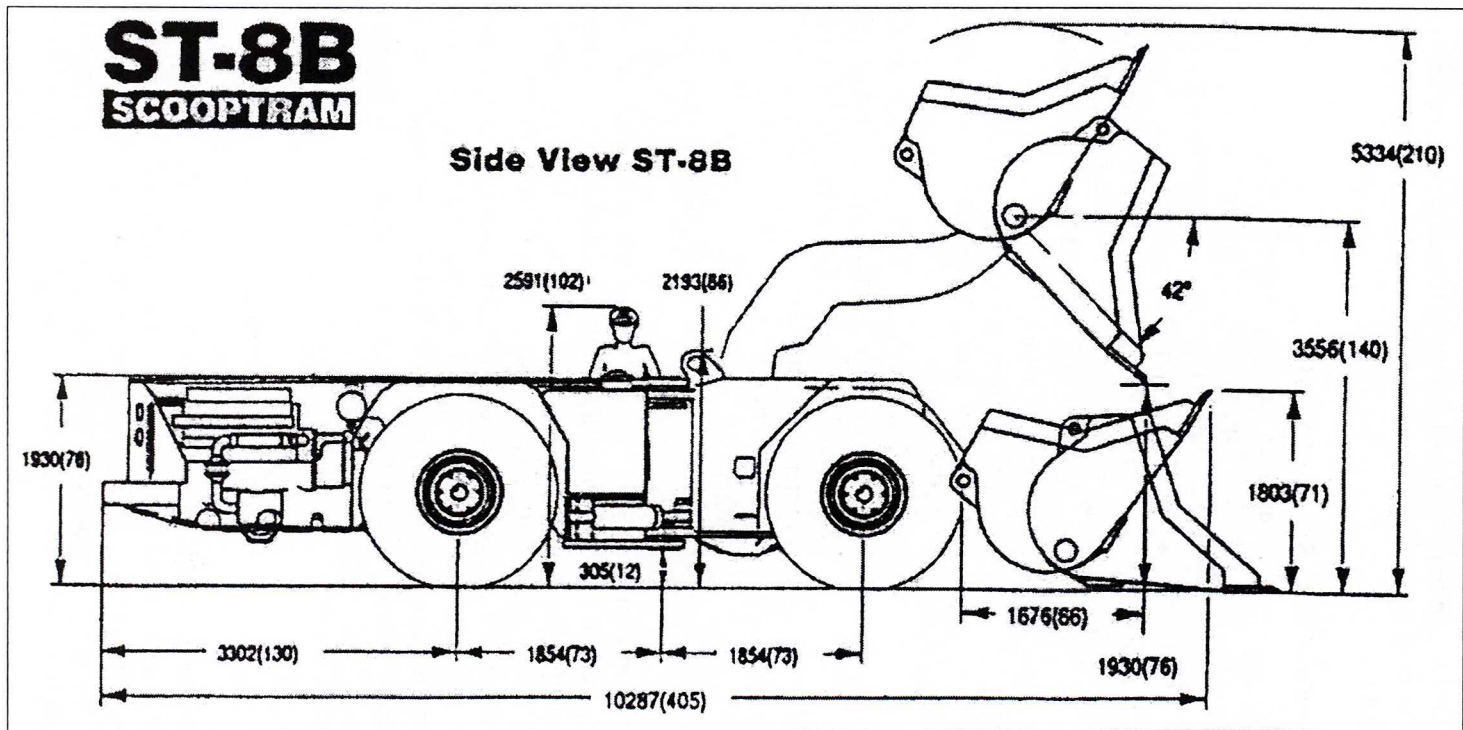

Fig. 1. ST-8B scooptram

Rys. 1. Ładowarka ST-8B

the power output is obtained from a computer hook-up to the diesel engine's electronic control module. The time and length of each vehicle operation is analyzed by viewing previously recorded files.

Technical Specification — Standard Version

Bucket	Tramming capacity:	13,608 kg
	Bucket capacity:	6.5 m ³
	Bucket dump time:	7 seconds
Transmission	4 Speeds Forward/Reverse	
Vehicle speed — Loaded:	Forward or Reverse with 3% Rolling Resistance	
	Gear: 1 st — 4.7 km/h; 2 nd — 8.0 km/h;	
	3 rd — 13.4 km/h; 4 th — 22.3 km/h	
Torque converter	Single Stage, Clark C-8000 Series	
Exhaust conditioner	Catalytic Purifier plus Exhaust Silencer	
Tank Capacity	Fuel — 380 litres; Hydraulic — 360 litres	
Dump/Hoist System Pressure	13.8MPa	
Engine	Deutz Diesel	F12L-413FW
	Power Rating @ 2,3000 rpm	210kW (285hp)
	Maximum Torque @ 1,500 rpm	975Nm (719ft-lb)
	Number of Cylinders	12, in "V"
	Displacement	19,1L
	Cooling	Air
	MSHA Ventilation	679 m ³ /min (24,000cfm)

In order to develop accurate cycle times for mucking, tramming and dumping, the company's tele-remote database information was used. Data files collected from the loader monitoring system in the past were used. Due to the extensive amount of data available, it was decided that only one-day files from 26/09/01 be analyzed so that average durations for the specific operations could be determined. They contained all the information necessary for the analysis since the LHD was mucking at that time in the same area as during the time of testing. This information was then used with the power measurements obtained separately at a later day to calculate the final duty cycle.

4. Location of testing

The loader operated on the 4350 level of a deep metal mine. Fig. 2 is a plan drawing of the level showing the drawpoints and location of the dump (O.P.). During the time of testing, the LHD was mucking in the 351 drawpoint or the furthest drawpoint to the left on the plan. This drawpoint is significant as it is the longest tram on which the scoop operates out of. The tram route can be described as rough, with pieces of loose rock on the main track.

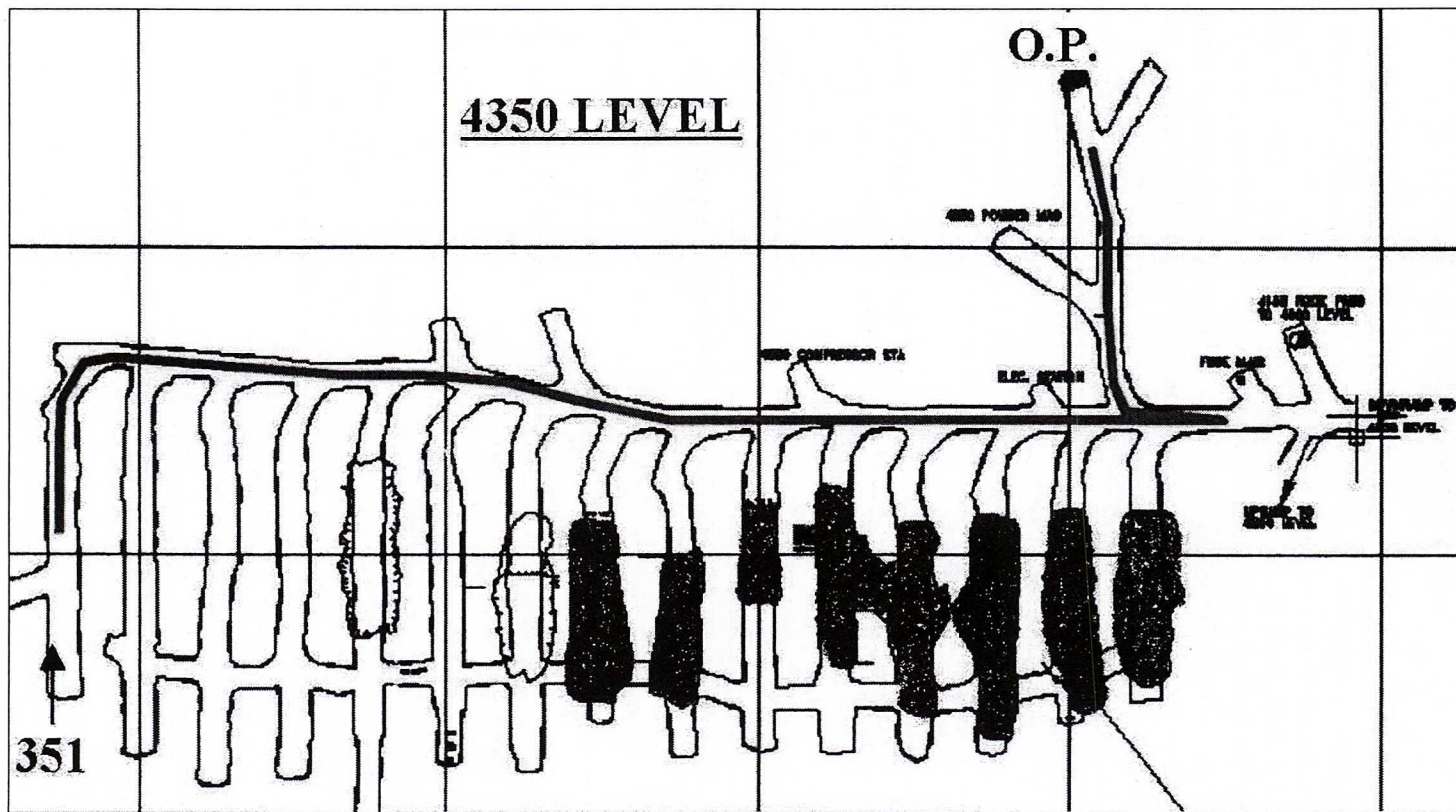

Fig. 2. Route of LHD

Rys. 2. Trasa ruchu ładowarki (LHD)

5. LHD movement

The first file analyzed contained pressure and temperature readings and the current track position values. This information was recorded in approximately 2-second intervals throughout the entire day, making it quite a lengthy file. The first stage in the analysis process was to graph the temperature and pressure data in order to establish if there were any trends that could be isolated to determine a starting point for one complete underground cycle. Once the pattern of a whole cycle could be established, it would be possible to break down the other operations of the LHD, namely the forward and reverse tramming. Fig. 3 is a graph of one complete cycle of operation for the loader showing the pressures and temperatures. As shown, the engine and converter pressures are relatively constant throughout the course of one cycle; however, there is a noticeable spike in the temperatures. These spikes indicate an increase in temperature in the engine and converter. This would be expected during mucking operations. Knowing this, the information could now be correlated with additional data to further analyse one complete cycle.

The next stage was to determine the motion of the LHD using its automation guidance cycle information. Two files stored the data in binary format, meaning that the

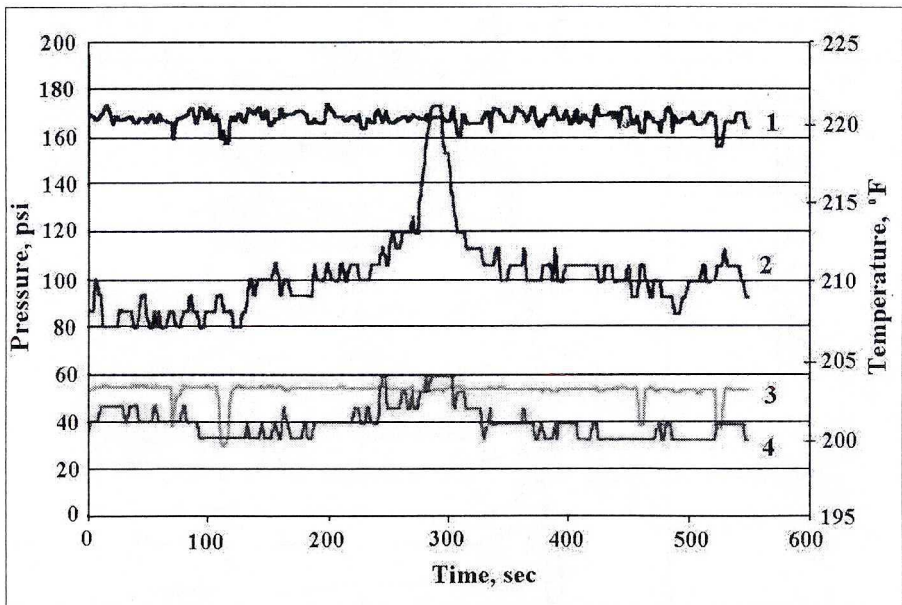

Fig. 3. Engine and converter temperatures and pressures
1 — converter oil pressure, 2 — engine oil pressure, 3 — converter oil temperature, 4 — engine oil temperature

Rys. 3. Temperatura i ciśnienie oleju silnika i konwektora
1 — ciśnienie oleju konwektora, 2 — ciśnienie oleju silnika, 3 — temperatura oleju konwektora,
4 — temperatura oleju silnika

value 1 or -1 represents the system as being on, while 0 indicates off. In the *Guide Cycle File* a value of 1 in third column indicated that the LHD was under automation and moving in the forward direction. A value 1 in fourth column indicated the same except the LHD was travelling in reverse gear. The fifth column displayed whether the scoop had a full bucket or whether it was moving empty. The first two columns displayed the date and real time. Second file, the *Gauges Diesel File*, contained data illustrating how the scoop was moving at any given time. The *Power On* and *Stop Engine* columns in this file indicated whether the LHD's power was on or off. This file also indicated whether the LHD was in automation mode, shown by a 1 or -1 in the *Fwd Guide* or *Rev Guide* columns, or whether the LHD was controlled by the operator, as shown by an absolute 1 value in the *Tele* columns.

By combining the two files, an accurate description of the motion of the LHD has been established. Fig. 4 shows the movement graph of the LHD during one complete cycle. As shown, a value of 1 represents movement in the forward direction, while a value of -1 is movement in the reverse direction. A 0 -value indicates the LHD being stopped or stationary. The length of each section indicates the duration of the movement.

The start of the cycle begins with a stationary pause after dumping of muck at the orepass (O.P.). This is shown on Fig. 4 by 0 -value section at time zero, as the LHD is stationary when dumping. The reverse movement of the LHD takes place and is followed by second stationary pause. This pause indicates the switch from reverse gear

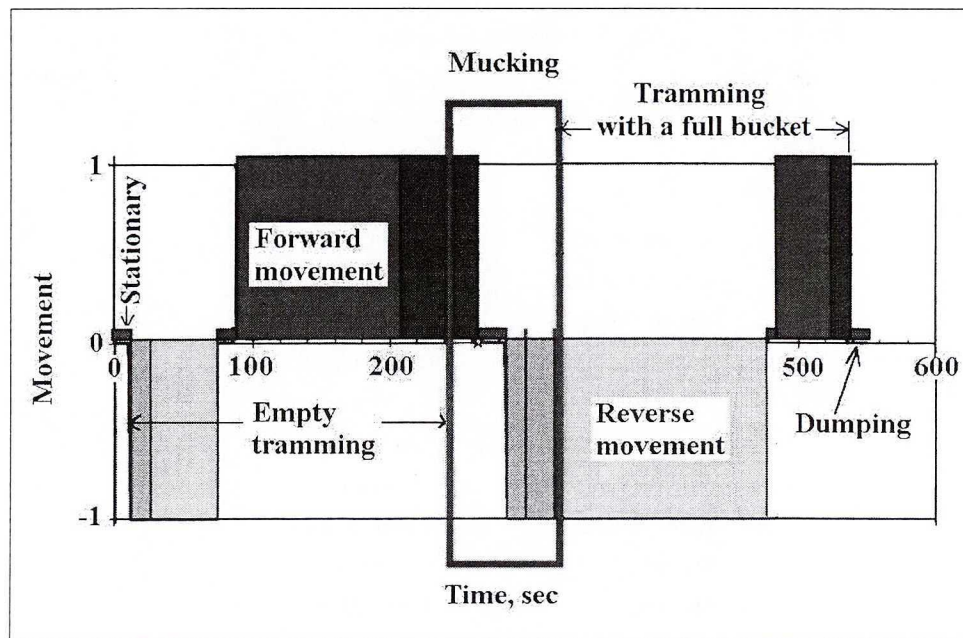

Fig. 4. LHD motion during one complete cycle

Rys. 4. Fazy ruchu ładowarki

to forward gear. The remaining sections of the graph represent the mirror image of the LHD back from the stope to the dump.

In Fig. 4 the movement is distinguished between tele-remote and fully automated operation. The dark areas of the graph represent when the LHD was in tele-remote or when the operator was controlling it. The light areas show when the scoop was under automation. When analyzed, it can be seen that the operator is only controlling the scoop when they are either exiting or entering the dump and during the mucking operation. When temperatures from Fig. 3 are overlaid on Fig. 4, it would become apparent that all the information is accurate and a complete cycle has been established. As expected, there is significant rise in engine oil temperature and converter oil temperature during the mucking process.

The average times for each operation are displayed in Table 2. It should be noted that these times represent the average values for each operation on the longest tram based on more than thirty cycles. The tramming times in the automation mode will vary according to the drawpoint the LHD is mucking in. For instance, if the LHD is in a closer drawpoint, the distance to tram would be shorter and therefore the average times less. However, it is assumed that no matter what drawpoint the LHD is operating in, the average mucking, dumping and stationary times would remain constant.

TABLE 2

Average operation times

TABLICA 2

Uśrednienie czasów etapów operacji

Operation	Average time
Complete cycle	9 min, 3 sec
Total tramming	7 min, 13 sec
Tramming empty	200 sec (approx.)
Tramming loaded	232 sec (approx.)
Tele-reverse	25 sec
Auto-reverse	3 min, 6 sec
Tele-forward	34 sec
Auto-forward	2 min, 26 sec
Stationary	16 sec
Mucking	1 min, 23 sec
Dumping	11 sec

6. Engine power

In order to calculate the actual power produced by the diesel engine, direct readings from the on-board electronic control monitoring system of the engine were taken on March 28th, 2002. The Wagner ST-8B LHD is a Detroit Diesel Series 60 DDEC 3, 215kW engine. This engine has an on-board electronic control module, termed the ECM, which is capable of monitoring engine performance characteristics as well as diagnosing engine malfunctions. The computer is equipped to monitor a variety of parameters including load, speed, rpm, and torque and fuel rate along with a variety of other engine characteristics. For this project however, only the parameters listed were used. To obtain the power output of the engine, horsepower had to be calculated from rpm and torque using Equation 1.

$$\text{Power output} = \frac{\text{rpm} \cdot \text{torque}(\text{ft} - \text{lb})}{5252} [\text{hp}] \quad (1)$$

To extract the data from the engine, a special software program was connected to the ECM. Detroit Diesel's Diagnostic Link Version 4.1 software was purchased from a dealer and installed on a portable laptop computer. Because the computer required a constant power source in order to operate for extended periods of time, an inverter system was used in conjunction with the LHD's batteries to provide a constant 120V ac power source. The inverter and computer were mounted on top of the battery panels of the LHD and secured with industrial tie wraps. The computer was hooked-up via a series of cables obtained with the software package to the DDEC terminal located on the dash of the LHD. After a series of complete cycles were performed, the recordings of the computer were saved on the hard disk and the equipment was removed from the LHD.

7. Analysis of engine data

An analysis of the collected data was performed in conjunction with the movement cycle to establish at exactly what times the LHD was mucking, tramming and dumping. The data obtained from the ECM had to be manually analyzed the same way the average cycle times were. When the data were examined, it was noticed that some of the values recorded were negative and that as a whole the data was extremely jumpy. In order to see any trends in raw data, the negative values were discarded, and all the parameters recorded were graphed. After examining the graphs and knowing how many complete cycles the LHD performed, a starting point for the cycle was established. The graphs were plotted so this starting point coincided with dumping at the orepass.

Fig. 5 shows the graphed fuel rate of the engine for one complete cycle of LHD. The values are extremely jumpy. This perhaps may be attributed to the vibration of the equipment.

When Fig. 5 is compared with Fig. 6, which displays the rpm and torque over the same time, it is obvious that there is a certain time pattern for the parameters. Between

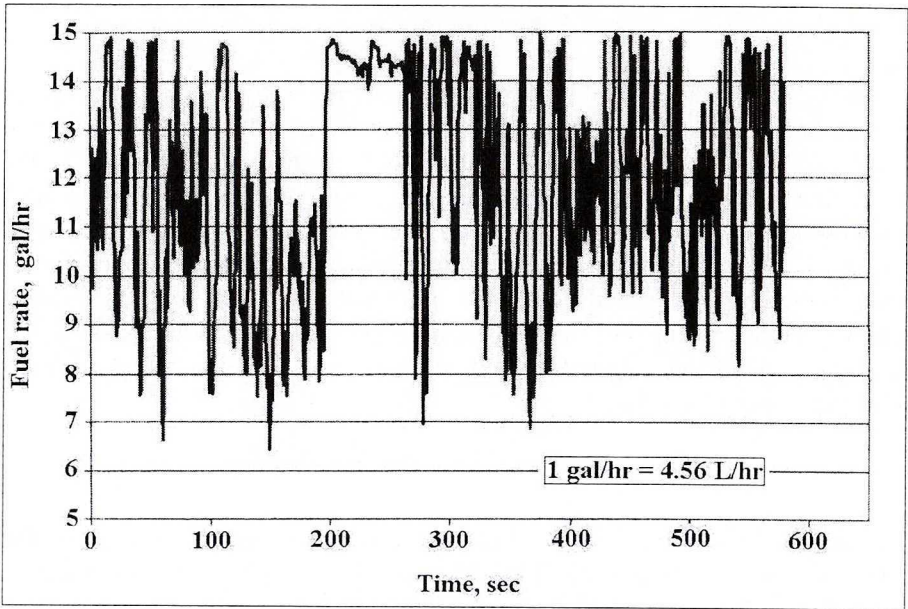

Fig. 5. Fuel rate

Rys. 5. Zużycie paliwa

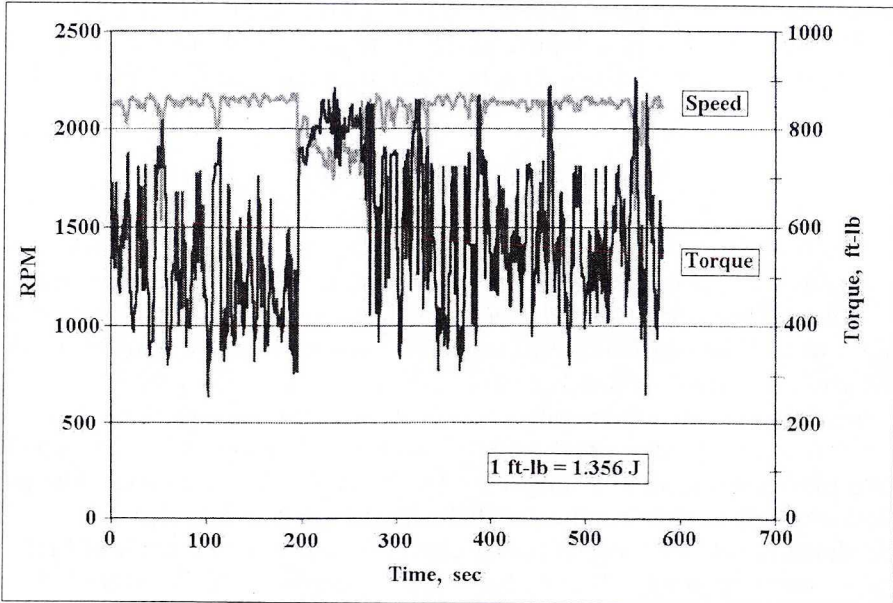

Fig. 6. Engine rpm and torque

Rys. 6. Prędkość i moment obrotowy silnika

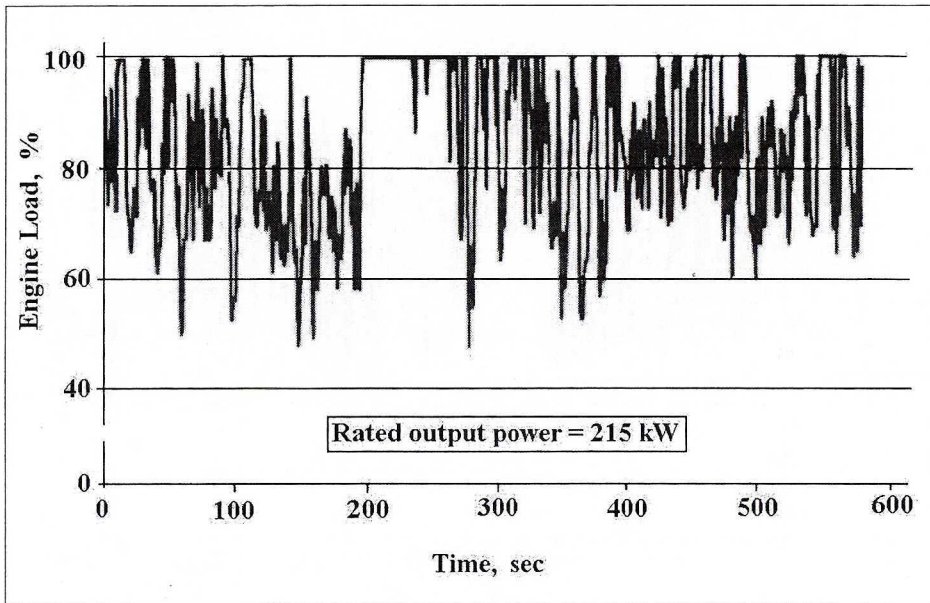

Fig. 7. Percent engine load

Rys. 7. Procentowe obciążenie silnika

200 and 275 seconds there is an interruption in values. In Fig. 5 the fuel rate remains above 14 gallons (63.8 litres) per hour, indicating load on the engine. This is also shown in Fig. 7 as a graph of the engine load percentage. During the same period, it can be seen in Fig. 6 that the rpm drops while the torque increases. This interruption is indicative of the mucking process. From these observations the mucking and tramming operations of the LHD could now be recognized.

8. Engine power cycle

Using Equation 1, the power cycle was calculated using data obtained from the laptop computer. Shown in Fig. 8 is the power cycle for one complete cycle, along with an average power cycle indicated by the solid (average) line. When analyzing this power cycle together with the movement cycle shown in Fig. 4, there are some immediate discrepancies, one being that there is not as many intervals or number of operations occurring.

Upon examining average values for the first segment of the cycle (0 to 200 seconds), some conclusions can be made. First of all, this operation includes tramming from the orepass back to the stope. This is better illustrated in Fig. 9, which shows the average power cycle superimposed with the LHD movement for one complete cycle. At this stage in the cycle, the LHD is tramming empty and on its way back to the stope. The average values for the recorded parameters of this segment are given in Table 3.

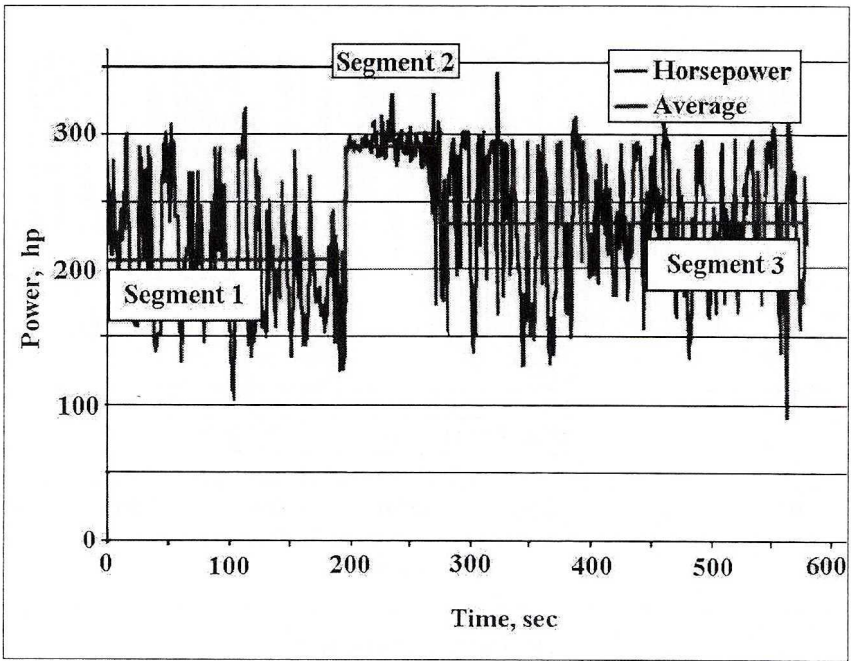

Fig. 8. LHD power cycle

Rys. 8. Cykl mocy ładowarki

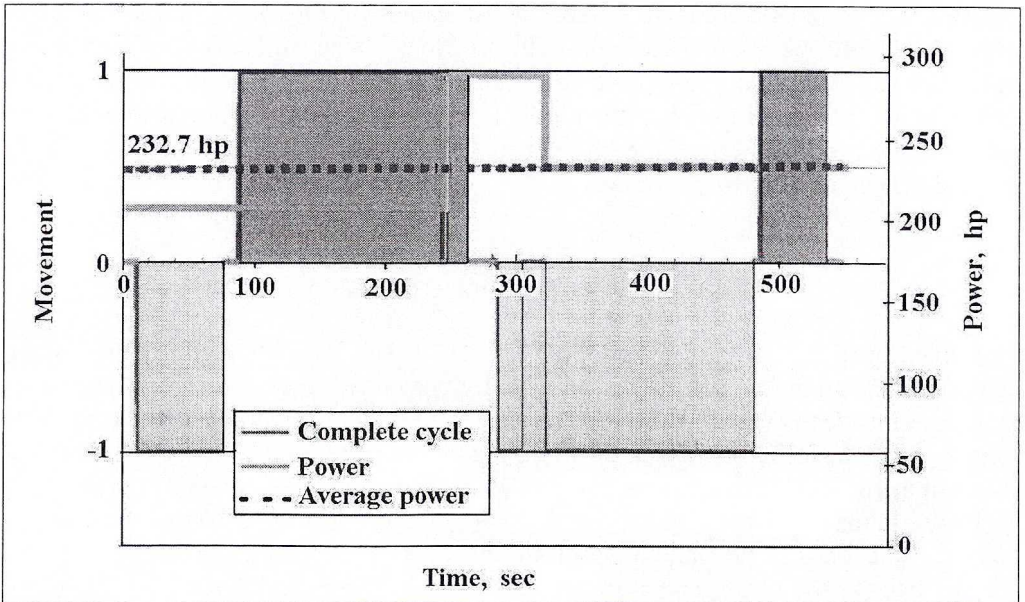

Fig. 9. Overlay of power cycle to LHD movement

Rys. 9. Fazy ruchu i zużycie mocy ładowarki

TABLE 3

Average values when tramming empty

TABLICA 3

Uśrednione parametry ładowarki podczas ruchu bez ładunku

Tramming empty				
rpm	Fuel [gal/L/hr]	Torque [ft-lb/J]	Engine load [%]	Power [hp/kW]
2095.8	11.2/51.1	520.7/706.0	79.5	207.8/154.9

The second segment in the average power cycle is the mucking operation. This segment is between 200 and 275 seconds (Fig. 8) and shows a significant increase in power requirements. The average values obtained from this segment are given in Table 4. When comparing tramming empty and mucking there is a significant drop in rpm, while all other parameters significantly increase. The fuel rate, torque, engine load and power were all expected to increase during the mucking operation, however rpm was not. It is hypothesized that this decrease in rpm is resulting from the increased load on the engine; increasing the torque requirements and decreasing the speed at which the engine is able to spin. The final segment in the duty cycle that can be distinguished occurs when the LHD is tramming the ore back to the orepass. Table 5 represents the average values calculated when the LHD is loaded and on its way back to the orepass.

When values in Table 5 are compared to the data in Tables 3 and 4 it can be seen that there is an increased load, torque, and power output and fuel rate over empty LHD tramming. In addition, the rpm's are lower which is indicative of the previous hypothesis. These values can be applied to their respective operation (tramming empty, mucking and tramming loaded) for any length of time, allowing the calculation of a duty cycle for any time or cycle period.

TABLE 4

Average values for mucking

TABLICA 4

Uśrednione parametry ładowarki podczas ładowania

Mucking				
rpm	Fuel [gal/L/hr]	Torque [ft-lb/J]	Engine load [%]	Power [hp/kW]
1929.8	14.2/64.8	789.3/1,070	98.4	290.0/216.3

Average values when tramming loaded

Uśrednione parametry ładowarki podczas ruchu z ładunkiem

Tramming loaded				
rpm	Fuel [gal/L/hr]	Torque [ft-lb/J]	Engine load [%]	Power [hp/kW]
2105.3	11.9/54.3	583.0/790.5	83.7	233.7/174.3

9. Results

The results of the power cycle can be broken down in peak, average and energy storage this LHD requires for one complete cycle. If required, these values can be simply multiplied by the number of buckets per shift to get the energy storage requirements for an entire shift. Although the information is jumpy and the raw data indicates spikes in power reaching 320hp (239kW), the peak power requirements on an average basis during the experiment were 290hp (216kW) in the mucking operations. In spite the fact that this value is slightly higher than the rated output, it represents the power required for this particular unit to muck in any heading and represents the maximum designed power output of an advanced power system.

The energy storage requirement, E_{cycle} for one complete cycle, is the integral of the duty cycle. This value can be found using Equation 2. In this equation, ($Avg\ hp$) is the average horsepower, while ($Time$) is the average duration for segment 1 in seconds. Subscript 1 refers to tramming empty, subscript 2 — mucking and 3 — tramming loaded.

$$E_{\text{cycle}} = 0.7458 \cdot \sum_{i=1}^{i=3} [(Avg\ hp) \cdot (Time)]_i \text{ [kJ]} \quad (2)$$

The average power for the cycle is the value obtained dividing E_{cycle} by the duration of the entire cycle, $(Time)_{1+2+3}$, as shown in Equation 3.

$$\text{Average power} = \frac{E_{\text{cycle}}}{(Time)_{1+2+3}} \text{ [kW]} \quad (3)$$

The results of the calculations can be seen in Table 6 and Table 7.

TABLE 6

Average power and energy expenditure per LHD operation

TABLICA 6

Średnie zużycie mocy i energii podczas pełnego cyklu pracy ładowarki

Vehicle Operation	Average Power Requirements [kW/hp/operation]	Time [sec]	Energy Expenditure [kJ/ft-lb/operation]
Tramming empty	154.9/207.8	200	30,980/22,858,000
Mucking	216.3/290.0	83	17,953/13,238,500
Tramming loaded	174.3/233.7	232	40,438/29,820,120

* 1 hp = 550 ft-lb/s

It should be noticed that the average times in Table 6 represent values given in Table 2 and not those indicated in Fig. 8. This is because Table 1 is based on an extensive data and therefore describes accurately the movement of the LHD.

TABLE 7

Peak, average power and energy storage requirements

TABLICA 7

Maksymalne i średnie zapotrzebowanie mocy i energii

Duration	One Complete Cycle	One Shift (30 buckets)
Average Power [kW/hp]	173.6/232.7	173.6/232.7
Peak Power [kW/hp]	216.3/290.0	216.3/290.0
Energy Storage [kJ/ft-lb]	89,371/65,916,620	2,6801,130/1,977,498,600

In Table 7, the energy expenditure for dumping and stationary periods is not included. However, it can be estimated that the excluded operations may require an additional 200 kW (268 hp) for 27 seconds or 5,500 kJ (4,056,000 ft-lb). Therefore, the LHD needs in total 95 MJ (70,058,997 ft-lb) per cycle.

10. Conclusions

Although the power cycle has been calculated, it is the recommendation of the author that it not be used for the final development of any advanced power systems. The data

collections for the power calculations were done over a period of approximately 25 minutes and hence, 2 complete cycles only. In addition, because of the limitations of the workplace, no data was collected during the LHD tramping up or down a ramp. For a complete power cycle, considerations must be made to collect data from the widest number of variables. This means that the collection should take place in different workplaces, with different operators and under a wider variety of conditions such as tramping up or down a ramp, loaded or unloaded, and during dumping and stationary periods.

If further work is to be done on this project, it is also recommended that the LHD be made available solely for the purpose of the project. The time and length of each vehicle operation should be manually recorded or could be viewed after taping it on a time stamped VHS tape. During the progress of this project, it was very difficult to coordinate with all accompanying parties schedules. For these reasons, it is suggested that if further work is done, it be done at an experimental mine, where all the resources can be made available.

REFERENCES

- Anon, 2001. The development of fuel cell vehicles for underground mines; www.fuelcelltoday.com
- Anon, 2002. Hydrogen Fuel Cells; www.nrcan.gc.ca/canmet-mmsl
- Document, 2001. Fuelcell Propulsion Institute, Advanced Underground Vehicle Power and Control: Phase 2, Foundation of Fuelcell Power and Automated Control. Privileged Document.
- Document, 2002. Detroit Diesel Corporation, Brochures — Series 50 and 60 DDEC Engines.
- Gaibler D.W., Miller A.R., 1998: Cost model for fuelcell mine vehicles: conservative analysis of recurring and capital costs. Fuelcell Propulsion Institute.
- Miller A.R., 2000: Fuel-cell mine vehicle — development and testing. Proceedings of the 2000 Hydrogen Program Review.
- Moller C., Lucks R., 2000. Seminar: Fuel Cells, WS 1999–2000.
- Story G.C., 2000: Hydride bed/fuelcell project. Proceedings of the 2000 Hydrogen Program Review.

REVIEW BY: PROF. DR HAB. INŻ. ADAM KLICH, KRAKÓW

Received: 13 June 2003