

On the 0/1 test for chaos in continuous systems

 M. MELOSIK¹ and W. MARSZALEK^{2*}
¹Poznan University of Technology, Department of Computer Science, 3A Piotrowo St., 61-138 Poznan, Poland

²Rutgers University, Department of Mathematics, 110 Frelinghuysen Road, Piscataway, NJ 08854, USA

Abstract. In this paper we discuss in detail the resonance and oversampling features of the 0/1 test for chaos in continuous systems and propose methods to avoid those undesired features. Our method is based on certain frequency properties of the 0/1 test. When reconstructing the phase space, our approach is compared with the first minimum of the mutual information method. Several numerical results for typical chaotic systems (including memristive circuits) are included.

Key words: test 0/1 for chaos, oversampling, phase space reconstruction, mutual information, FFT.

1. Introduction

The 0/1 test for chaos is a new test to check for chaos in deterministic discrete and continuous systems [1–4]. The test can be applied when the underlying mathematical model of a system is unknown. The size of the system is irrelevant. Also, a relative simplicity of the test and the binary nature of the final result – parameter $K \approx 1$ for chaotic and $K \approx 0$ for regular signals – made the test an attractive tool in examining signals and systems. Analysis of the properties of the 0/1 test and its interesting applications can also be found in [5–9]. While the 0/1 test for chaos can be applied to discrete and continuous signals, it appears (based on the literature) that the test is mostly used to examine discrete signals. The continuous case is different from the discrete one, as certain extra issues must be taken into considerations when analyzing chaotic signals and systems. The problems with resonance, oversampling and the length of interval of parameter c (see below), when not properly addressed, may yield false results.

This paper discusses the above problems with the test applied to continuous signals. We propose certain rules one should use when the 0/1 test for chaos is applied. The resonance and oversampling issues are addressed in the context of their frequency features. Our analysis of those issues results in a frequency characterization of the test in relation to the parameters $c \in (0, \pi)$ used in the test. The frequency approach is also applied to the phase space reconstruction process and we compare our approach with the method of first minimum of mutual information.

2. The 0/1 test fundamentals

The 0/1 test (see [1–13] for details) is a relatively new tool used to test the presence of chaos in digital sequences when a mathematical model (system of equations) is not available.

The result of the test has two forms: a single real number K , and a two-dimensional graph with translation variables p and q [1]. For a chaotic sequence the number K should be close to 1. Regular (non-chaotic) sequences result in numbers K closer to 0. The values of K can be computed by using two different methods: regression or correlation.

For a sequence $\{N_k\}$, $k = 0, \dots, \bar{N} - 1$, the variables p and q are computed by the following expressions for a randomly chosen real number $c \in (0, \pi)$

$$p_c(n) = \sum_{j=0}^n N_j \cos[(j+1)c], \quad q_c(n) = \sum_{j=0}^n N_j \sin[(j+1)c] \quad (1)$$

with $n = 0, \dots, \bar{N} - 1$. Then, the mean square displacement $M_c(n)$, $n = 0, 1, \dots, n_{cut}$, of $p_c(n)$ and $q_c(n)$ is computed with the recommended integer value $n_{cut} \approx (\bar{N} - 1)/10$

$$M_c(n) = \lim_{\bar{N} \rightarrow \infty} \frac{1}{\bar{N}-1} \sum_{j=0}^{\bar{N}-1} [p_c(j+n) - p_c(j)]^2 + [q_c(j+n) - q_c(j)]^2. \quad (2)$$

Next, if the regression method is applied, then the asymptotic growth rate K_c of the mean square displacement is computed as follows:

$$K_c = \lim_{n \rightarrow \infty} \frac{\log M_c(n)}{\log n}. \quad (3)$$

On the other hand, if the correlation method is applied, then two vectors $\xi = (0, 1, 2, \dots, n_{cut})$ and $\Delta = (M_c(0), M_c(1), M_c(2), \dots, M_c(n_{cut}))$ are created. The correlation coefficient K_c is obtained as follows:

$$K_c = \text{corr}(\xi, \Delta) \equiv \frac{\text{cov}(\xi, \Delta)}{\sqrt{\text{var}(\xi)\text{var}(\Delta)}} \quad (4)$$

where *cov* and *var* stand for covariance and variance, respectively [2].

*e-mail: w.marszalek@rutgers.edu

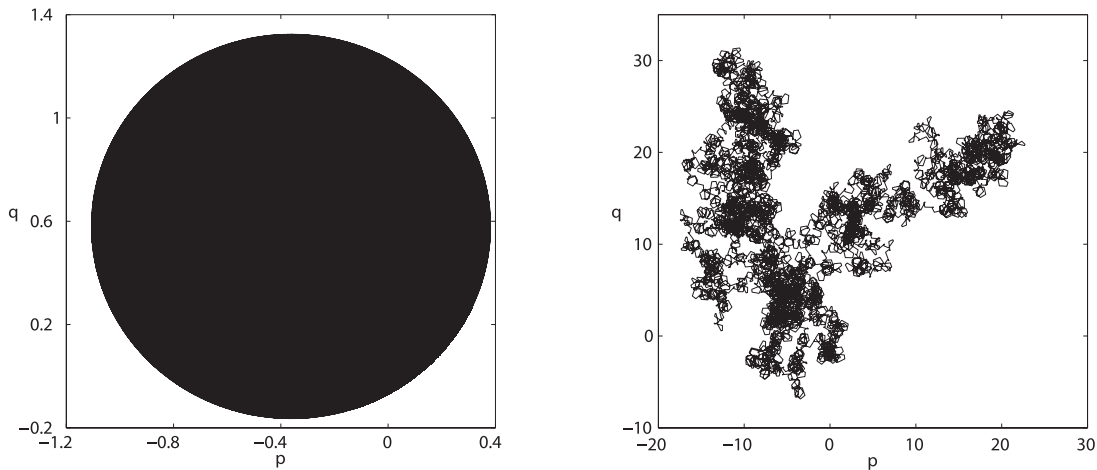

Fig. 1. The 0/1 test results for logistic map. Variables $q - p$ for: (left) logistic map with $\mu = 3.50$ yields $K = 0.0015$ (regular sequence), (right) logistic map with $\mu = 3.99$ yields $K = 0.9982$ (chaotic sequence)

In both methods the above steps are repeated for N_c values of c chosen randomly in the interval $(0, \pi)$. Again, [2] recommends $N_c = 100$. Finally, the median of the N_c values of K_c is the final number K . The $K \approx 1$ indicates a chaotic sequence $\{N_k\}$, while $K \approx 0$ indicates regular (non-chaotic) dynamics. For more details about the 0/1 test, its properties and reliability in the discrete case one can see [10, 11].

Based on the sequences of p and q values one can create two-dimensional plots of q versus p . For regular (non-chaotic) or weakly chaotic sequences (i.e. K close to 0 or significantly lower than 1, respectively), the q versus p plot has a regular two-dimensional shape, while for chaotic sequences (i.e. K close to 1) the shape is irregular (a Brownian motion). We used se-

quences of 5000 numbers in all our calculations. Also, $n_{cut} = 10$ and $N_c = 100$. Figure 1 show typical graphs $p - q$ for regular and chaotic signals. We used the logistic map $x(n + 1) = \mu x(n)[1 - x(n)]$ with $\mu = 3.50$ (regular case), $\mu = 3.99$ (chaotic case) and $0 < x(0) < 1$.

3. Resonance and oversampling

A series of numerical experiments with the 0/1 test for chaos applied to continuous signals are presented in this section. Figure 2 shows countinuous signals obtained by adding sine waves as follows:

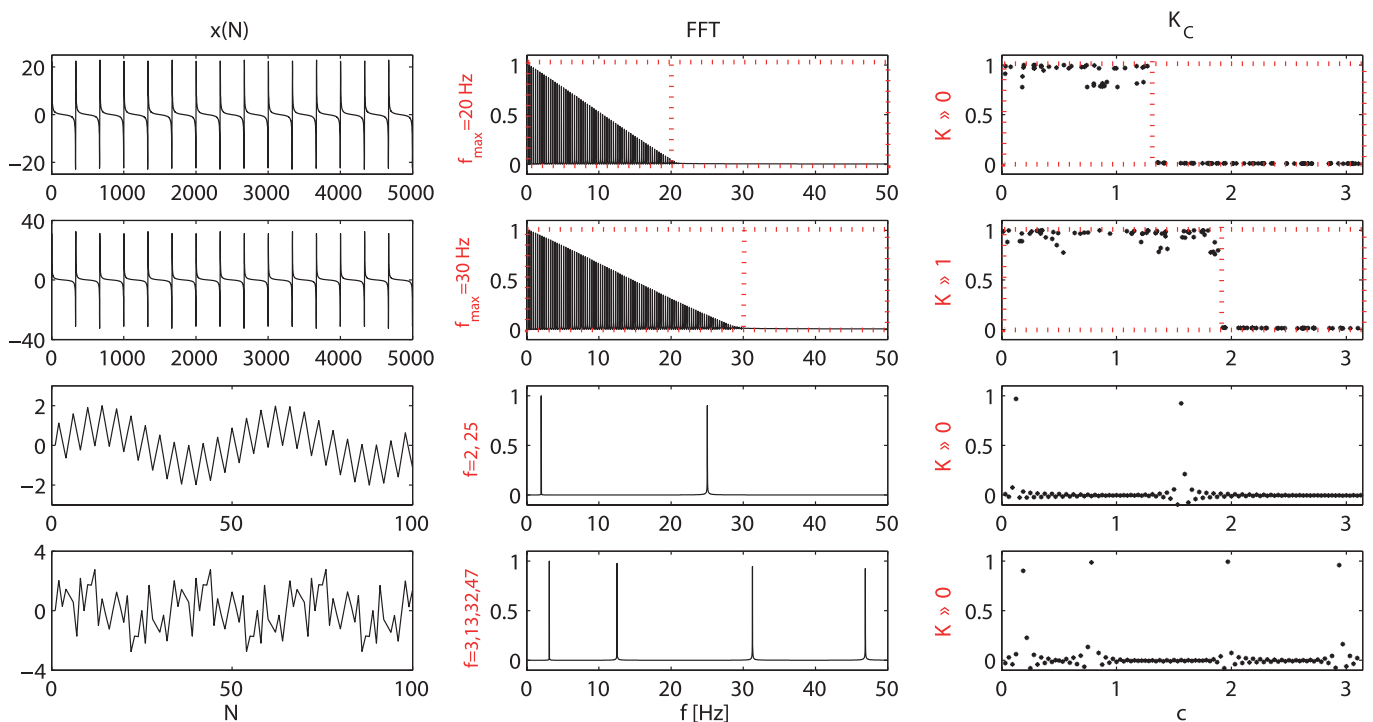

Fig. 2. Series of sine waves (various frequencies plus resonance)

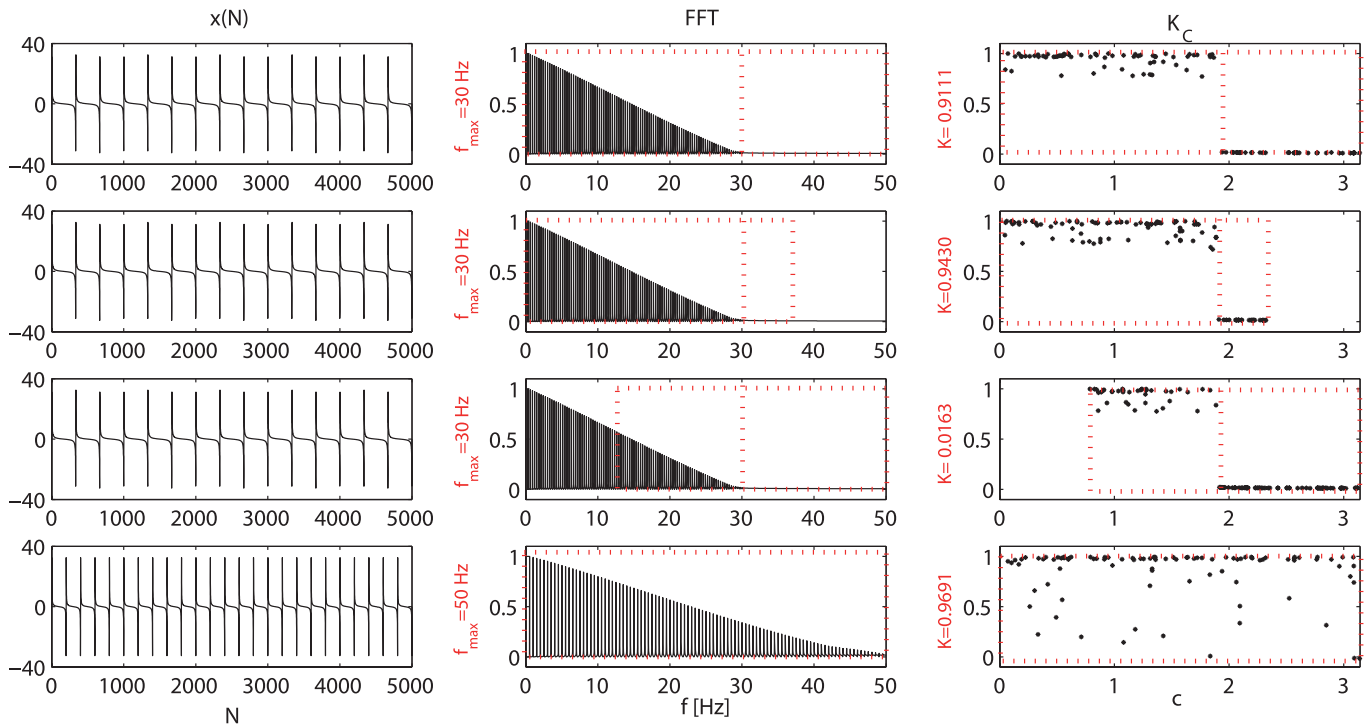

Fig. 3. Series of sine waves (various frequency and c intervals)

- (1) first and second panels: sum of 70 and 100 sine waves with frequencies spaced equally from 0.3 Hz to 21 Hz and 0.3 Hz to 30 Hz, respectively, and linearly decreasing amplitudes.
- (2) third panel: sum of two sine waves with frequencies 2 and 25 Hz and amplitude 1.
- (3) bottom panel: sum of four sine waves with frequencies 3, 13, 32 and 47 Hz and amplitude 1.

A sampling rate of $dt = 0.01$ seconds was used to create $x(N)$ for $0 \leq t \leq 5000 dt$ for all four signals. The first two signals are shown for $N = 1, \dots, 5000$, while the last two for $N = 1, \dots, 100$ in the first column in Fig. 2. The FFTs of the signals are shown in the second column and the results of applying the 0/1 test for chaos in the third column. The 100 values of $c \in (0, \pi)$ in the top and second panel were chosen by using Matlab's function *rand* with $c = rand(1, 100)\pi$, while those in the third and bottom panels were chosen uniformly spaced in the interval $(0, \pi)$. Similar results are shown in Fig. 3. Notice that the values of c in the top and bottom panels were kept as before, that is $0 \leq c \leq \pi$, while those in the second and third panel were restricted to $0 \leq c \leq 3\pi/4$ and $\pi/4 \leq c \leq \pi$, respectively. The final test results K are included in the third column in Fig. 3.

Observation 1. Figures 2 and 3 clearly indicate a one-to-one correspondence between the value of f_{max} in the analyzed signals and the obtained values of K_c , and, as a consequence, the final value of K . Both figures show non-chaotic (i.e. regular) signals for which, in most cases, the 0/1 test gives false results of $K \approx 1$ (as in the second panel in Fig. 2 and the last panel in Fig. 3). In the former, the values of c for which $K_c \approx 1$ are such that $c \in (0, \frac{3}{5}\pi)$, while for $c \in (0, \frac{3}{5}\pi, \pi)$ we have $K_c \approx 0$. This is due to the fact that the spectrum of the signal in the second

panel in Fig. 2 falls into the range $(0, \frac{3}{5}\pi(\frac{f}{2}))$. In the latter, the $K_c \approx 1$ for all $c \in (0, \pi)$ and the signal's spectrum is in the whole range $(0, (\frac{f}{2}))$. We used $dt = 0.01$, for which $\frac{f}{2} = 50$ Hz. Notice that the same property holds true in the first panel in Fig. 2, but we have here $K \approx 0$, since the spectrum of the signal has frequencies $(0, \frac{21}{50}(\frac{f}{2}))$, therefore the corresponding interval of c with $K_c \approx 1$ is $c \in (0, \frac{21}{50}(\frac{f}{2}))$. Since the other interval $c \in (\frac{21}{50}\pi, \pi)$ has more values of c for which $K_c \approx 0$ than the interval $c \in (0, \frac{21}{50}\pi)$ with $K_c \approx 1$, therefore the median value is $K = median(K_c) \approx 0$. Also, the second and third panels in Fig. 3 follow into the same pattern with the reduced length of the interval of c values. Finally, the third and fourth panels in Fig. 2 illustrate the resonance property of the 0/1 test. In the third panel the two frequencies of the signal are 2 Hz, or $\frac{2}{50}(\frac{f}{2})$ Hz, and 25 Hz, or $\frac{25}{50}(\frac{f}{2})$. The uniformly spaced c values in the 0/1 test were chosen in such a way that two of those values are exactly equal $\frac{2}{50}\pi = \frac{\pi}{25}$ and $\frac{25}{50}\pi = \frac{\pi}{2}$. This leads to $K_c \approx 1$ for the two c values. The same happens with four frequencies and four c values in the bottom panel in Fig. 2.

Figure 4 shows the results of the 0/1 test for Lorenz system with solutions obtained by using Matlab's *ode45* solver with constant step size $dt = 0.01$, initial conditions $[10^{-10}, 0, 1]$, $abserr = relerr = 10^{-6}$ and $0 \leq t \leq 400$. After the constant step solution is computed, we create four sequences of 5000 values taken every T samples from $t = 400$ backwards. We used $T = 1$ (top panel), 2 (second panel), 4 (third panel) and 8 (bottom panel). The $x(N)$ values (first variable in Lorenz system) are shown in the first column in Fig. 4, while the normalized FFT plots are shown in the second column. Finally, the third column shows the K_c values and the median K values in the four cases for parameter $c \in (0, \pi)$ obtained by using the *rand* function from Matlab.

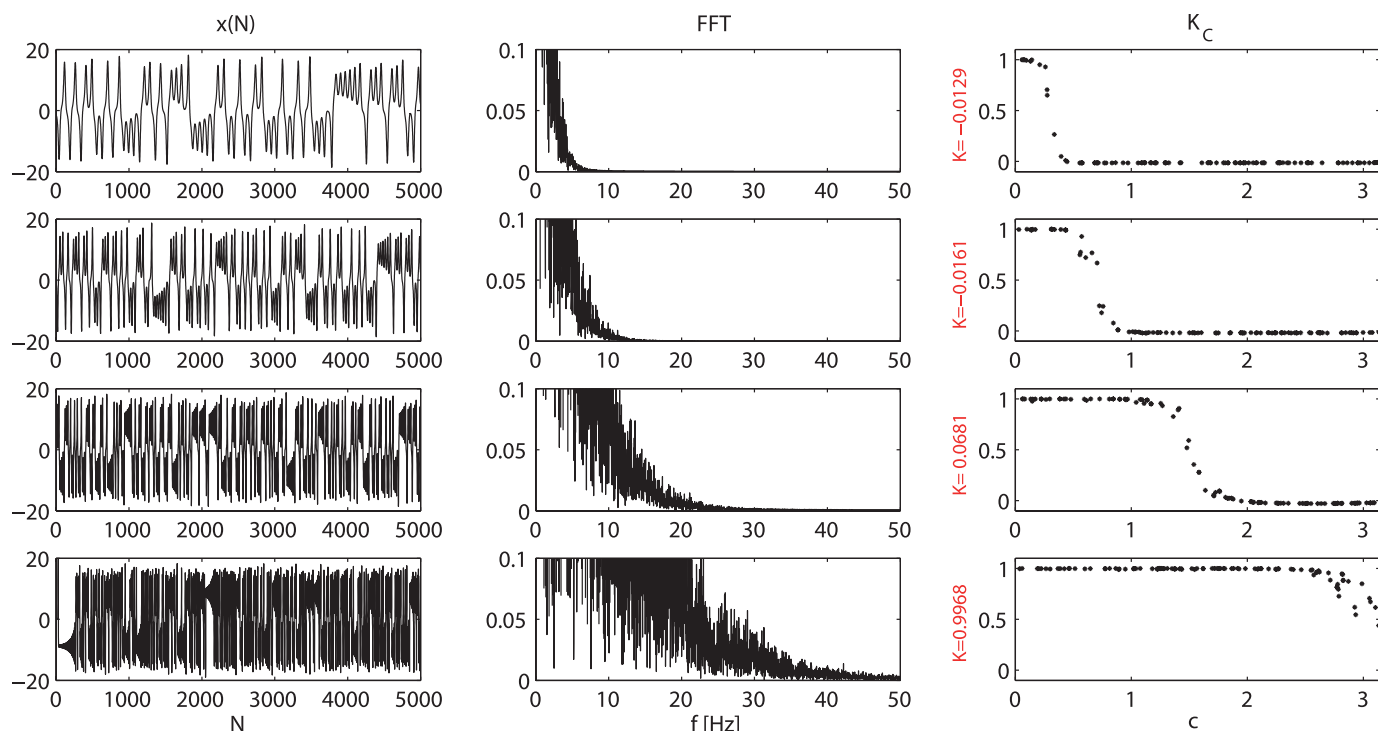

Fig. 4. Signals $x(n)$ constructed every 1, 2, 4 and 8 samples

Observation 2. Oversampling occurs in the first three panels in Fig. 4. The number of c values with $K_c \approx 1$ in the three cases is smaller than the number of c values for which $K_c \approx 0$. This yields $K = \text{median}(K_c) \approx 0$. Such a phenomenon can be explained in term of the f_{max} values of the signals and the sampling frequency in a way similar to the cases shown in Figs. 2 and 3. For example, in the first panel in Fig. 4 we have, based on the FFT graph in the second column, $f_{max} \approx 6$ Hz. Since $dt = 0.01$, then $f_s/2 = 50$ Hz. The ratio $6/50$ translates into the corresponding graph in the third column as $\frac{6}{50}\pi = 0.38$. Thus, for $c \in (0, 0.38)$ we have $K_c \approx 1$, while for all $c \in (0.38, \pi)$ we have $K_c \approx 0$ and, since the length of the interval $(0.38, \pi)$ is bigger than that of $(0, 0.38)$ we obtain $K = \text{median}(K_c) \approx 0$, the false result. Note that the same phenomenon occurs in the second panel with $f_{max} \approx 13$ Hz and the values $c \in (0, \frac{13}{50}\pi)$ with $K_c \approx 1$. The same is repeated again in the third panel in Fig. 4. Finally, the oversampling does not occur in the last panel (with $T = 8$) since we have now $f_{max} \approx 50$ Hz $= f_s/2$, so for all values $c \in (0, \pi)$ we have $K_c \approx 1$, which yields $K \approx 1$. The 0/1 test indicates a chaotic signal. It appears that the case $T = 4$ (third panel in Fig. 4) is a *borderline* case, since f_{max} appears to be close to 25 Hz, that is, close to $\frac{1}{2}(\frac{f_s}{2})$. It follows from the above observation that the oversampling will not occur in this example for values of T greater or equal 5, as for $T \geq 5$ we have $f_{max} > \frac{1}{2}(\frac{f_s}{2})$ and the corresponding interval of c with $K_c \approx 1$ is $(0, c_{max})$, $c_{max} > \pi/2$, yielding $K \approx 1$. \diamond

Figure 5 also illustrates the oversampling case. The chaotic (blue) signal on the left side is oversampled and results in the $q - p$ diagram of regular shape (in the middle). However, when the same (blue) signal is used to create a new one by choosing every 18th sample (the red sequence), then the $q - p$ diagram is

of Brownian nature (red plot on the right side). For continuous signals it is suggested that the value of T should be taken as the first local minimum of the *mutual information* [14]. Such a value should be used for reconstruction of the phase space.

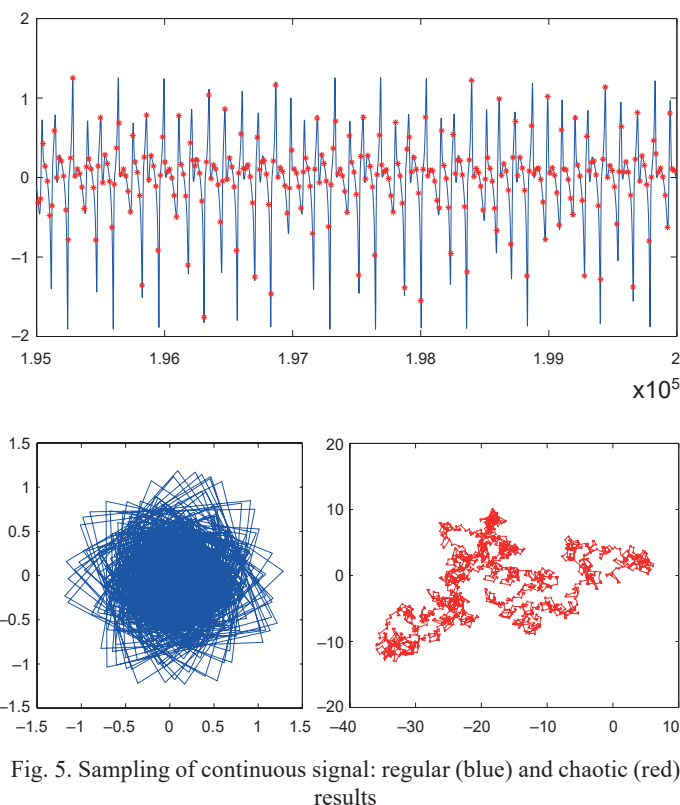

Fig. 5. Sampling of continuous signal: regular (blue) and chaotic (red) results

Another method used for solving the oversampling problem is based on local maxima and minima of the original time series sequences. Such an approach is used to study chaos in shape memory alloys oscillations [7], [15]. As indicated by our examples in section 6, the first minimum of the *mutual information* is not always a good choice. The methods proposed in this paper – a simple frequency analysis and FFT – lead, quite often, to much better results.

4. Frequency properties of the 0/1 test in continuous case

The frequency properties of the 0/1 test and its parameters $c \in (0, \pi)$ are evident from the examples in the previous section. Moreover, the following theorem was proved in [2].

Theorem. Discrete power spectrum of the 0/1 test is

$$S(f) = \lim_{n \rightarrow \infty} (1/n) E \left| \sum_{j=0}^{n-1} e^{2\pi i \frac{f}{f_s} j} \phi(j) \right|^2 (\Delta t)^2. \quad (5)$$

with $E(v) \equiv \lim_{N \rightarrow \infty} (1/N) \sum_{j=1}^N v(j)$ and $f_s = 1/\Delta t$. \diamond

Note that in the 0/1 test of the sequence $\phi(j)$ the power spectrum can be written in general as (5) with a summation $\sum_{j=0}^{n-1} e^{i c j} \phi(j)$, $i^2 = -1$. This fact and the theorem above indicate that $c = 2\pi \frac{f}{f_s}$, which is a discrete frequency when a sampling of a signal with continuous frequency f is done. Therefore, the parameter c of the 0/1 test for chaos is a discrete frequency. Thus, we have the following results:

- The c is really a discrete frequency!
- Since $0 \leq c \leq \pi$, $f_s \geq 2f_{max}$ (Nyquist) but $K = \text{median}(K_c)$, therefore the 0/1 test $f_{max} > f_s/4$.
- If $f_s > 4f_{max}$, then the oversampling occurs and the 0/1 test requires (practically) shows $K < 1/2$, that is a non-chaos, even when the tested signal is chaotic. \diamond

The above analysis indicates that, when applying the 0/1 test, one needs to carefully choose sampling of a continuous chaotic signal based on the spectrum of that signal and in order to prevent oversampling we should have $f_{max} > f_s/4$. Otherwise, the test will produce $K \approx 0$, even when the 0/1 test is applied to a chaotic signal. Satisfying the frequency condition for a *regular* (non-chaotic) signal may still lead to a false result $K \approx 1$, as shown through the examples in Figs. 2 and 3 of periodic non-chaotic signals.

In the next section we show further experiments and comparison of the frequency approach to the 0/1 test with the *mutual information* one. This is done in the context of a reconstruction of phase space using the tested signal.

5. Mutual information

Consider systems S and Q consisting of discrete sets of possible messages s_n with probabilities $P_s(s_n)$, and q_n , with probabilities $P_q(q_n)$.

Definition 1. The average amount of information gained from a measurement that specifies s is the entropy H of a system

$$H(S) = - \sum_{i=1}^N P_s(s_i) \log P_s(s_i) \quad \text{for } S \quad (6)$$

$$H(Q) = - \sum_{j=1}^N P_q(q_j) \log P_q(q_j) \quad \text{for } Q.$$

Mutual information (or MI), $I(Q, S)$, of variables q and s is a quantity that measures how much one variable tells us about another. High $I(Q, S)$ indicates a large reduction in uncertainty, while a low $I(Q, S)$ indicates a small reduction.

Definition 2. Given a measurement of s , the $I(Q, S)$ is the number of bits of q that can be predicted, where $I(Q, S) = H(Q) + H(S) - H(S, Q)$ with $H(S, Q)$ denoting the average amount of information gained from measuring (s, q) , that is $H(S, Q) = - \sum_{i=1}^n \sum_{j=1}^m P_{sq}(s_i, q_j) \log P_{sq}(s_i, q_j)$.

The following result from [14] is relevant to our analysis of continuous signals and systems as it gives a method of reconstructing of phase space based on the tested chaotic continuous signal $x(t)$.

Observation 3. The variable $x(t)$ from $\{x(t), y(t), z(t)\}$ ensures reconstruction of phase-space by expanding x as $\{x(t), x(t+T), x(t+2T)\}$, that is $\{x(t), y(t), z(t)\} = \{x(t), x(t+T), x(t+2T)\}$ where T corresponds to the first minimum of mutual information $I(x(t_i), x(t_i+T))$. It is assumed that the dimension (which is 3 in the above observation) of dynamic system is known or should be determined by special methods. \diamond

6. MI versus the frequency approach

The $I(x(t_i), x(t_i+T))$ of Lorenz system is shown in Fig. 6 with the first minimum at $T = 18$.

Figure 7 shows, from left to right, the original attractor, plus six reconstructed ones for $T = \{2, 5, 8, 12, 18, 60\}$. The MI approach indicates the reconstruction with $T = 18$. Notice, however, that Fig. 7 suggests that visually better attractors are obtained for T between 5 and 8 and the frequency analysis (see Fig. 4) confirms that fact, indicating the smallest T value for

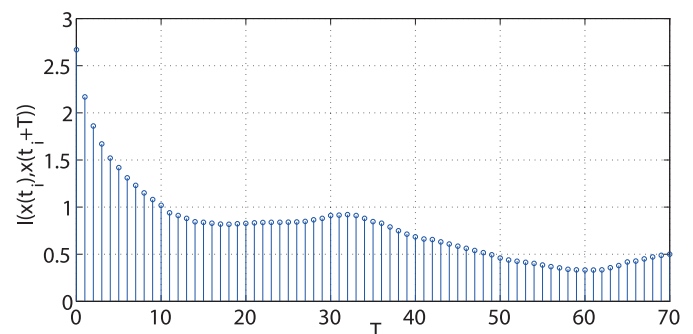

Fig. 6. Mutual information $I(x(t_i), x(t_i+T))$ versus T

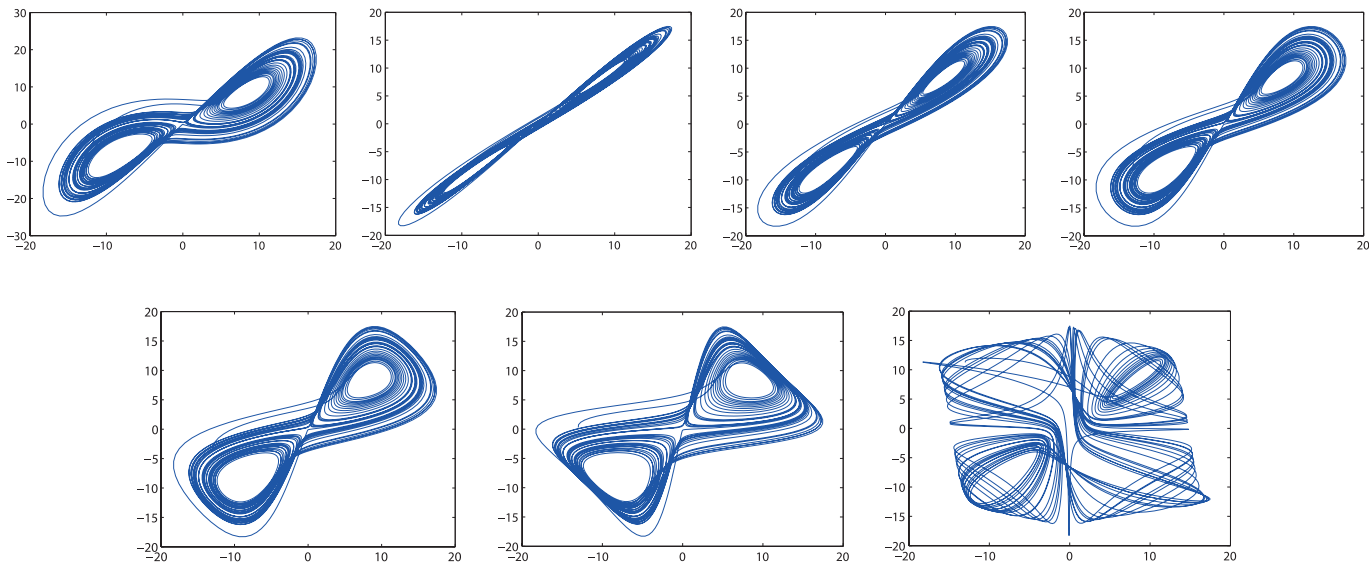

Fig. 7. Attractors $\{x(t_i), y(t_i)\}$, $\{x(t_i), x(t_i + 2)\}$, $\{x(t_i), x(t_i + 5)\}$, $\{x(t_i), x(t_i + 8)\}$, $\{x(t_i), x(t_i + 12)\}$, $\{x(t_i), x(t_i + 18)\}$, $\{x(t_i), x(t_i + 60)\}$

a chaotic signal to be $T = 5$, but the values of 6 and 7 seem to be even better. Thus, the frequency method gives a more accurate result than the MI approach which suggests $T = 18$.

We have also compared the MI and frequency approaches to analyze memristive circuits with mixed-mode and chaotic oscillations [16–18]. For a certain set of parameters we obtained the first minimum of *mutual information* at $T = 17$ as shown in Fig. 8 (for the circuits in Fig. 9 [17]). However, Fig. 10 shows that the value $T = 17$ results in a rather poorly reconstructed attractor. The first minimum of mutual information does not give an acceptable value of T for the purpose of an attractor reconstruction, and a significantly better attractor is obtained for much smaller value than $T = 17$. The attractors obtained with $T = 4, 5$ or even 7 are much closer to the actual attractor $\{x(t_i), y(t_i)\}$ than the one reconstructed with $T = 17$.

The frequency approach for this case results in a graph similar to that in Fig. 4 and indicates that the smallest value of T for which the 0/1 test gives $K \approx 1$ is $T = 3$. Thus, the frequency

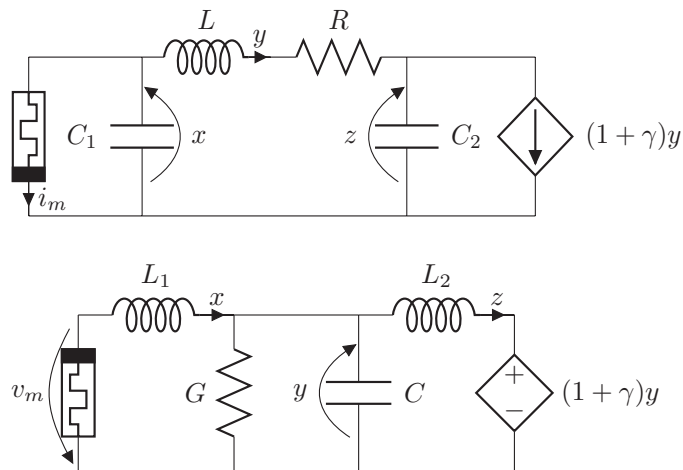

Fig. 9. Two dual memristive circuits with MMOs [17]

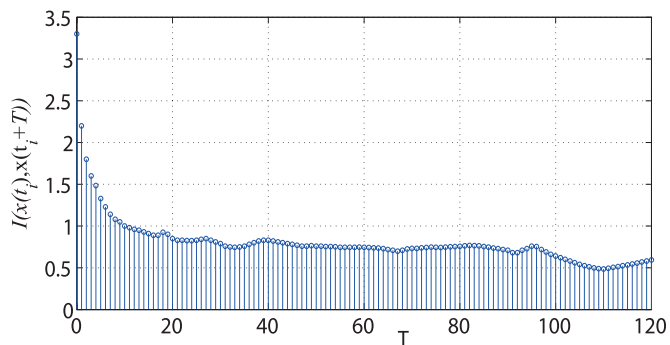

Fig. 8. Mutual information $I(x(t_i), x(t_i + T))$ versus T

method again gives a much better value of T (which should be around 4 or 5 for the phase space reconstruction) than the MI approach which yields $T = 17$.

7. Conclusion

This paper discusses the implementation of the 0/1 test for continuous signals and systems and characterizes the test in the frequency domain. From that we derive certain rules that should be followed when applying the test for continuous systems. This is one of the contributions of the paper. The oversampling phenomenon may lead to incorrect test results. To prevent such results to occur one should examine the spectrum of the tested

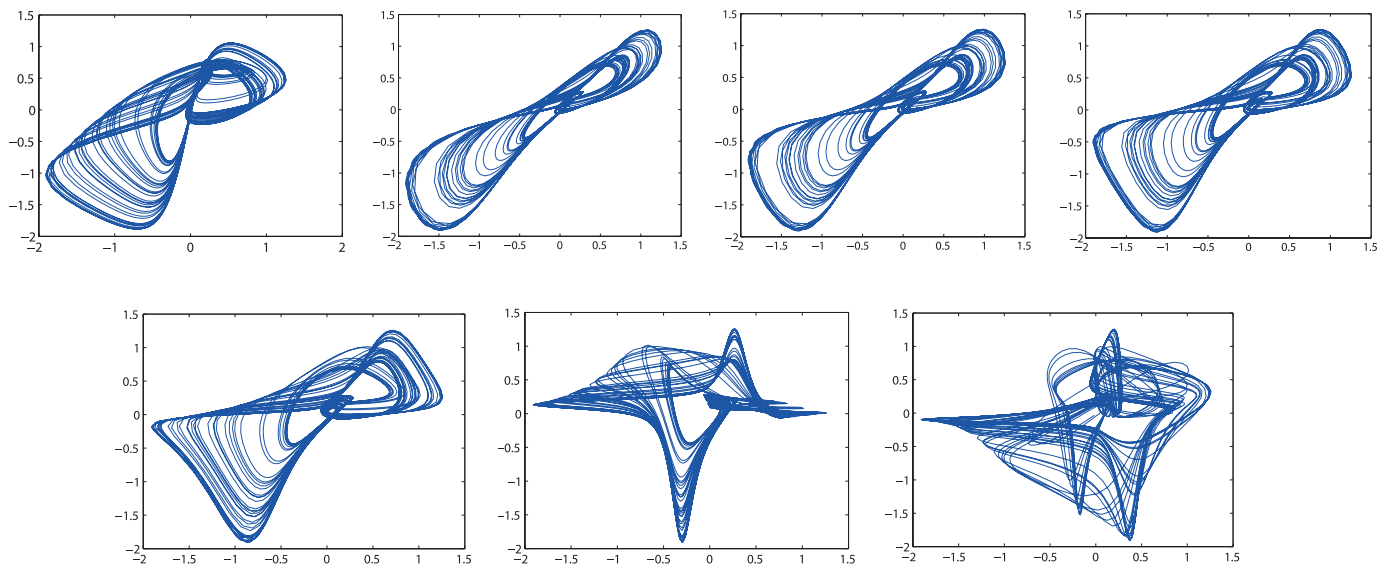

Fig. 10. Attractors $\{x(t_i), y(t_i)\}$, $\{x(t_i), x(t_i + 3)\}$, $\{x(t_i), x(t_i + 4)\}$, $\{x(t_i), x(t_i + 5)\}$, $\{x(t_i), x(t_i + 7)\}$, $\{x(t_i), x(t_i + 17)\}$, $\{x(t_i), x(t_i + 110)\}$

signal and select f_s such that $2f_{max} < f_s < 4f_{max}$, where the lower bound is the well-known anti-aliasing condition. If $f_s > 4f_{max}$, then applying the 0/1 test to chaotic continuous signals will always yield incorrect results and the chaotic signals will be identified as non-chaotic with $K \approx 0$. Another contribution of the paper is that our analysis and the two numerical examples in section 6 indicate that the frequency approach seems to be advantageous over the *mutual information* method when a phase space reconstruction is considered.

Also, the 0/1 test for chaos can be integrated with the electronic design automation programs, see for example [19]. Moreover, the test can be used to evaluate chaotic signals obtained by applying the OTA-C circuit design approach. The OTA-C approach is suitable for continuous time chaotic circuits discussed in [20, 21].

Acknowledgements. The authors would like to thank the anonymous reviewers for their constructive comments on the earlier version of the paper. The work of the first author was partially supported by the grant 09/94/DSMK/0057 “Improving security in the chaos based cryptography”. The paper is based on a talk presented at NUMDIFF-14, Halle (Germany), 7–11 September 2015.

REFERENCES

- [1] G. A. Gottwald and I. Melbourne, “A new test for chaos in deterministic systems”, *Proc. Royal Soc. London* 460, 603–611 (2003).
- [2] G. A. Gottwald and I. Melbourne, “On the implementation of the 0–1 test for chaos”, *SIAM J. Appl. Dyn. Syst.* 8, 129–145 (2009).
- [3] G. A. Gottwald and I. Melbourne, “On the validity of the 0–1 test for chaos”, *Nonlinearity* 22, 1367–1382 (2009).
- [4] D. Bernardini and G. Litak, “An overview of 0–1 test for chaos”, *J. Braz. Soc. Mech. Sci. Eng.* DOI :10.1007/s40430-015-0453-y (2015).
- [5] G. Litak, A. Syta, and M. Wiercigroch, “Identification of chaos in a cutting process by the 0–1 test”, *Chaos, Solitons and Fractals* 40, 2095–2101 (2009).
- [6] G. Litak, A. Syta, M. Budhbraja, and I. M. Saha, “Detection of the chaotic behaviour of a bouncing ball by the 0–1 test”, *Chaos, Solitons and Fractals* 42, 1511–1517 (2009).
- [7] G. Litak, D. Bernardini, A. Syta, G. Rega and A. Rysak, “Analysis of chaotic non-isothermal solutions of thermomechanical shape memory oscillators”, *Eur. Phys. J. Spec. Top.* 222, 1637–1647 (2013).
- [8] M. Romero-Bastida, M. A. Olivares-Robles, and E. Braun, “Probing Hamiltonian dynamics by means of the 0–1 test for chaos”, *J. Physics A* 42, 495102 (2009).
- [9] L. Zachilas and I. Psarianos, “Examining the chaotic behavior in dynamical systems by means of the 0–1 test”, *J. Appl. Math.* 2012, 681296 (2012).
- [10] Jing Hu, Wen-wen Tung, Jianbo Gao and Yinhe Cao, “Reliability of the 0–1 test for chaos”, *Phys. Rev. E*, 72, 056207 (2005).
- [11] J. H. P. Dawes and M. C. Freeland, “The 0–1 test for chaos and strange nonchaotic attractors”, <http://people.bath.ac.uk/jhpd20/publications/sna.pdf> (2008).
- [12] D. R. Chowdhury, A. N. S. Iyengar and S. Lahiri, “Gottwald-Melbourne (0–1) test for chaos in a plasma”, *Nonl. Proc. Geophys.* 19, 53–56 (2012).
- [13] I. Falconer, G. A. Gottwald, I. Melbourne and K. Wormnes, “Application of the 0–1 test for chaos to experimental data”, *SIAM J. Appl. Dyn. Syst.* 6, 395–402 (2007).
- [14] A. Fraser and H. Swinney, “Independent coordinates for strange attractors from mutual information”, *Phys. Rev. A* 33, 1134–1140 (1986).
- [15] J. Fouda, B. Bodo, S. Sabat and J. Effa, “A modified 0–1 test for chaos detection in oversampled time series observations”, *Int. J. Bifurc. Chaos* 24, 1450063 (2014).

- [16] W. Marszalek and Z. W. Trzaska, “Mixed-mode oscillations in a modified Chua’s circuit”, *Circuits Syst. Signal Process.* 29, 1075–1087 (2010).
- [17] W. Marszalek and Z. W. Trzaska, “Memristive circuits with steady-state mixed-mode oscillations”, *Electr. Lett.* 50 (18), 1275–1277 (2014).
- [18] H. Podhaisky and W. Marszalek, “Bifurcations and synchronization of singularly perturbed oscillators: an application case study”, *Nonl. Dynamics* 69 (3), 949–959 (2012).
- [19] P. Katarzynski, M. Melosik and A. Handkiewicz, “gC-Studio – the environment for automated filter design”, *Bull. Pol. Ac.: Tech.* 61 (2), 541–544, (2013).
- [20] J. M. Cruz and L. O. Chua, “An IC chip of Chua’s circuit”, *IEEE Trans. Circ. Syst.– II: IEEE Analog and Digital Sig. Proc.* 40 (10), 614–625 (1993).
- [21] B. Pankiewicz, S. Szczepanski and M. Wojcikowski, “Bulk linearized CMOS differential pair transconductor for continuous-time OTA-C filter design”, *Bull. Pol. Ac.: Tech.* 62 (1), 77–84 (2014).