

Method of estimating the exposure of the natural environment to 50 Hz electric and magnetic fields in power systems with distributed and centralized generations

MICHAŁ ZEŃCZAK

*West Pomeranian University of Technology, Szczecin
Faculty of Electrical Engineering
Al. Piastów 17, 70-310, Szczecin, Poland
e-mail: michal.zenczak@zut.edu.pl*

(Received: 10.06.2015, revised: 29.01.2016)

Abstract: The development of a distributed generation will influence the structure of the power transmission and distribution network. Distributed sources have lower power and therefore the lines of lower voltage are used. Therefore, the electric field intensity near such lines is lower. On the other hand magnetic field intensity may prove essential. The main aim of the paper is to present a method estimating the “ballast” of the natural environment at 50 Hz electric and magnetic fields in the power system, with distributed and centralized generation in real operating conditions.

Key words: distributed generation, electric field, magnetic field, power line

1. Introduction

There are three possible scenarios of development of an electric power system (EPS):

- extremely centralized EPS, with one large electric power station, or generation center,
- extremely distributed EPS with sources of electrical energy connected directly to consumers,
- a mixed structure of EPS with large power stations and distributed generation (DG).

The third scenario is the most likely options for the near future, as the sun and wind constitute main sources of energy for distributed generation, creating the need for large electric power stations. Besides small biogas electric power stations, small gas turbines, small water power stations and other distributed sources of electrical energy are not controlled by a dispatch centre of power transmission lines.

Figure 1 presents the structure of a power system with centralized generation (CG) and distributed generation (DG). The development of DG will influence the structure of the power transmission network as well as its distribution networks. The distributed sources have lower power, allowing for the use of lower voltage lines for sending power from these sources. Therefore, electric field (EF) intensity is lower near such lines. If one considers the currents, the

situation changes, as currents become essential at lower power and lower voltage. Although DG is connected to the distribution network (voltage of 110 kV and lower), the new sources within the distribution network may influence the currents in the power transmission lines (voltage of 220 kV and higher). Such a situation is possible when there are areas with very good wind conditions, but lacking larger consumers, such as towns, or industrial centers. Therefore, the essential part of the produced power (energy) flows into the power transmission lines. That fact may necessitate the development of not only the distribution network, but also the power transmission lines.

There are many methods of estimating EF intensity (E) and MF intensity (H) near power transmission lines [1-5]. The regular geometrical shape of transmission lines allows to precisely calculate the EF intensity and MF intensity values. For the purposes of the paper, the mirror reflection method and superposition method have been used for determining the distribution of EF intensity around the line. In order to calculate the MF intensity value, Biot-Savart's law and superposition methods have been used.

The main aim of the paper is to propose a method of estimating the exposure ("ballast") of the natural environment at EF and MF of 50 Hz generated by an electric power system with distributed and centralized generations and with load connected to different busbars.

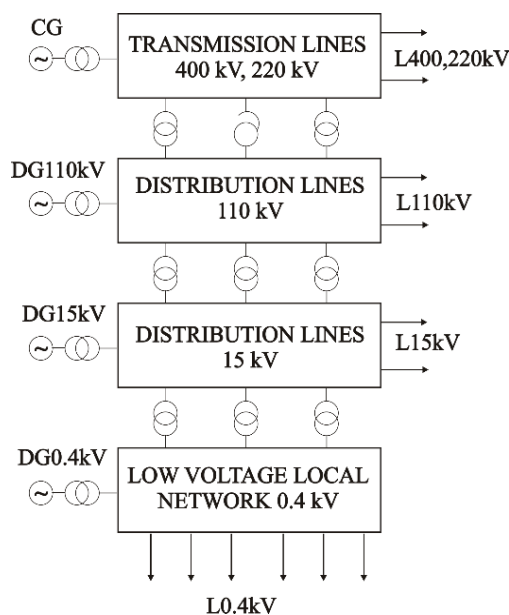

Fig. 1. Power system with distributed and centralized generations

2. Electric field near power lines

Electric field intensity near power lines is the function of the voltage and the configuration of the line. Configurations of lines are presented in Table 1. The higher the potential of the wires,

the bigger the charge on the wires and the higher electric field intensity. Besides the higher voltage of the line, higher distances between the wires are required. Therefore, the electric field intensity is higher, because the effect of the “alone phase” is approximated. On the other hand, the higher the voltage, the higher the required distance between the wires and the ground. This results in a lower electric field intensity under the wires, but at some distance from the line, the electric field intensity may be higher. The most important feature of the electric field near lines is the small variability of the rms value of EF intensity. The rms value of EF intensity is directly proportional to the rms value of the voltage within the lines, which should be within the range of $\pm 0.1 U_n$ or narrower. Therefore, approximately only the current structure of EPS influences the exposition of the natural environment at 50 Hz EF. The exposition at 50 Hz EF does not depend approximately on the present participation of DG and CG in total generation, as long as the structure of EPS does not change. However, the present currents within the wires can influence EF intensity, because the higher currents cause greater sag, which lowers the distance between the wires and the ground. Apart from that, higher currents cause a higher voltage drop. Additionally, weather conditions (wind speed, air temperature, solar radiation, humidity, air pressure) influence the temperature of the wires, which is directly linked to the sag.

Table 1. Configurations of 400 kV (tower Y52), 220 kV (tower H52) and 110 kV (tower B2), 15 kV and 0.4 kV (towers BSW)

Wire	Distance from axis [m]	Distance from ground [m]	Cross section [mm ²]
400 kV (Y52)			
L1	-10.30	7.80	2×525
L2	0.00	7.80	2×525
L3	10.30	7.80	2×525
Earth wire 1	-8.20	13.70	95
Earth wire 2	8.20	13.70	95
220 kV (H52)			
L1	-7.60	6.70	525
L2	0.00	6.70	525
L3	7.60	6.70	525
Earth wire 1	-5.60	10.80	70
Earth wire 2	5.60	10.80	70
110 kV (B2)			
L1	-3.6	5.85	240
L2	-2.8	9.45	240
L3	2.8	5.85	240
Earth wire	0.5	12.45	70
15 kV (BSW)			
L1	-1.85	5.6	70
L2	0	5.6	70
L3	1.85	5.6	70
0,4 kV (BSW)			
L1	-0.2	5.4	40
L2	0.2	5.4	40
L3	0.2	5	40
Neutral	-0.2	5	40

From a practical standpoint, the values set out by regulations are the most important factor. According to Polish regulations [6], the highest permissible value in the natural environment is 10 kV/m. In addition, housing construction is prohibited within the range of $E > 1$ kV/m. Other countries within the European Union observe similar values, mainly from the interval: 5 to 10 kV/m [7, 8]. Figure 2 presents electric field intensity near 400 kV, 220 kV and 110 kV lines. Figure 3 presents electric field intensity under 15 kV and 0.4 kV lines.

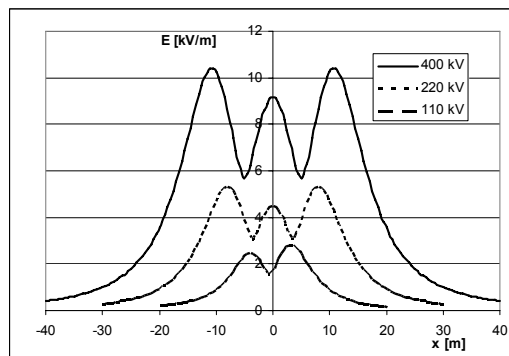

Fig. 2. Electric field intensity near 400 kV, 220 kV and 110 kV lines

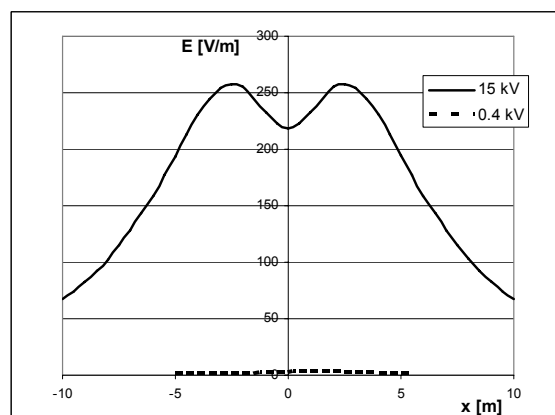

Fig. 3. Electric field intensity near 15 kV and 0.4 kV lines

3. Magnetic field near power lines

MF intensity near power lines is the function of the flowing currents and the configuration of the line. The rms value of MF intensity changes within a wide range, because the rms values of currents in phase wires change from $I \approx 0$ to the current-carrying capacity of the lines (I_{cc}). This changeability is caused by the variability of the load and the variability of the present participation of DG and CG in total generation. Generally, the exposition of natural environment to a 50 Hz MF depends on the present current-flow. The permissible value of MF intensity in the

natural environment is equal to 60 A/m [6]. In other countries within the European Union, the values are similar, mainly from the interval: 60 to 80 A/m [7, 8]. The same value is used in places appropriated for the public building [6].

MF intensity is proportional to the flowing currents. One interesting aspect is the result of a comparison of magnetic field intensities for the lines 400 kV, 220 kV, 110 kV, 15 kV and 0.4 kV on the typical towers.

For the same value of power flowing through the 400 kV, 220 kV, 110 kV, 15 kV lines, the current in the 15 kV line is the highest, while the current in the 400 kV line is the lowest. Therefore, MF intensity near the 15 kV line is higher than near the 110 kV, and more so near 220 kV and 400 kV [9].

On the other hand, due to the higher voltage and higher current carrying capacity of wires, the highest permissible value of power flowing through 400 kV is higher than the power flowing through 220 kV, and more so in the 110 kV, 15 kV and 0.4 kV lines.

Table 2 presents the values of current carrying capacity (I_{cc}) of wires AFL and AL [10]. The highest permissible temperature for common AFL conductors is 80°C. At present, not only AFL wires are used but also new conductors, allowing for higher permissible temperatures, up to +250°C [11]. Such conductors create new opportunities in terms of increasing the current-carrying capacity of power lines. Apart from the higher temperatures, conductors also have beneficial mechanical properties, such as their low level of sag. Due to this property, high temperature conductors with low sag are called HTLS (High Temperature Low Sag). They are an optimal replacement for old power transmission lines with low pylons and well suited for constructing new power transmission lines of high transmission capability. There are many types of HTLS conductors, some of which have a current-carrying capacity of $I_{cc} = 1030$ A. Finally, for the overhead 0.4 kV lines, mainly AL conductors are used.

Table 2. Current-carrying capacity (I_{cc}) of wires used in power lines

Wire [mm²]	525	240	120	70	50	35	HTLS	40 AL
I_{cc} [A]	1030	630	415	255	210	170	1030	200

Taking into consideration the current-carrying capacity of power transmission lines, it is possible to calculate how many lines of lower voltage are necessary in order to send the power from a line of higher voltage. Table 3 contains the results of these calculations.

The results from Table 3 show that one 400 kV power transmission line may be replaced by a very large amount of lines of lower voltage.

Electric field intensity near cable lines can be neglected due to the fact that phase wires are placed beneath a layer of soil and close one to one another. Magnetic field intensity above the ground and the buried cable lines can be quite significant, particularly when the phases are placed separately. Table 4 contains configurations of 110 kV and 15 kV cable lines buried underground with separated phases.

Figure 4 presents magnetic field intensity near 400 kV ($I = 2060$ A), 220 kV ($I = 1030$ A) and 110 kV ($I = 630$ A) lines. Figure 5 presents magnetic field intensity under 15 kV ($I = 255$ A) and 0.4 kV ($I = 200$ A) lines. Figure 6 presents magnetic field intensity 2 m and 0.3 m above the

ground with buried 110 kV ($I = 800$ A) cable lines. Figure 7 presents magnetic field intensity 2 m and 0.3 m above the ground with buried 15 kV ($I = 630$ A) cable lines.

Table 3. Amount of lower voltage lines necessary for sending the power from a higher voltage line

Lines	400 kV	220 kV	110 kV	110 kV	110 kV	15 kV	15 kV	15 kV
400 kV 2×525 mm ²	1	–	–	–	–	–	–	–
220 kV 525 mm ²	4	1	–	–	–	–	–	–
110 kV HTLS	8	2	1	–	–	–	–	–
110 kV 240 mm ²	12	4	2	1	–	–	–	–
110 kV 120 mm ²	19	5	3	2	1	–	–	–
15 kV 70 mm ²	216	60	30	19	12	1	–	–
15 kV 50 mm ²	262	72	36	22	15	2	1	–
15 kV 35 mm ²	324	89	45	28	18	2	2	1
0.4 kV 40 mm ²	10300	2833	1417	867	571	48	40	32

Table 4. Configurations of 110 kV and 15 kV cable lines

Wire	Distance from axis [m]	Depth [m]	Cross section [mm ²]
110 kV			
L1	-0.2	1.1	Cu 500
L2	0.0	1.1	Cu 500
L3	0.2	1.1	Cu 500
15 kV			
L1	-0.11	0.8	Al 500
L2	0	0.8	Al 500
L3	0.11	0.8	Al 500

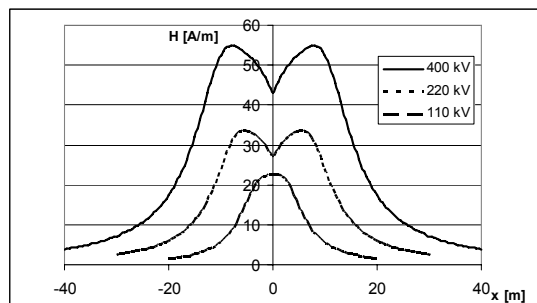

Fig. 4. Magnetic field intensity near 400 kV, 220 kV and 110 kV lines

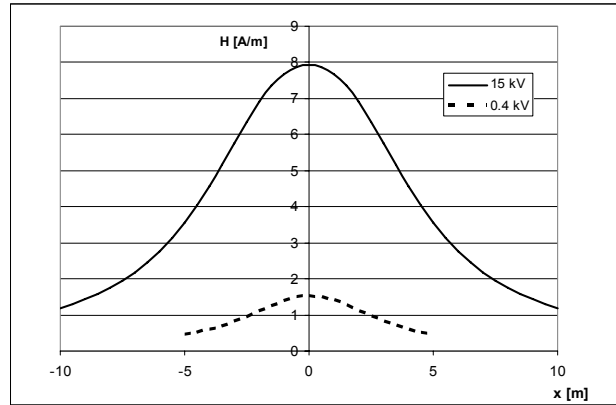

Fig. 5. Magnetic field intensity near 15 kV and 0.4 kV lines

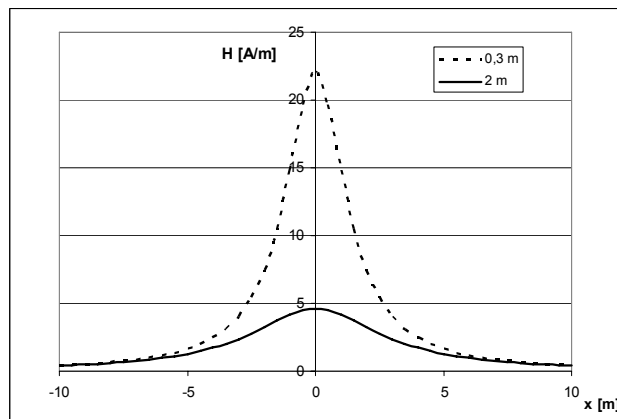

Fig. 6. Magnetic field intensity 2 m and 0.3 m above the ground with a buried 110 kV cable line

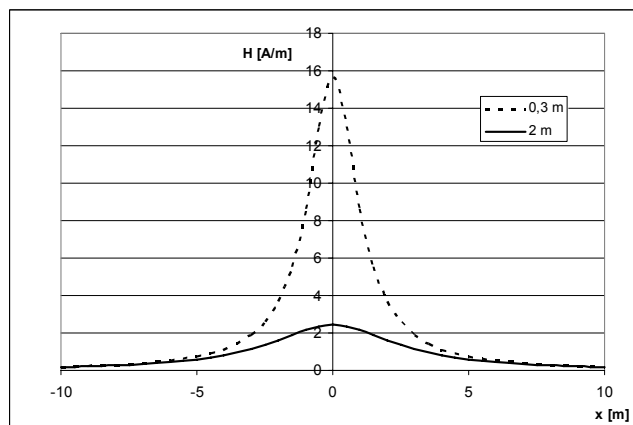

Fig. 7. Magnetic field intensity 2 m and 0.3 m above the ground with a buried 15 kV cable line

4. Power system with DG and CG

The balance of generated power P_G and power of load P_L in EPS should be fulfilled:

$$P_{CG400,220} + P_{DG110} + P_{DG15} + P_{DG0.4} = P_G, \quad (1)$$

$$P_G = P_L = P_{L400,220} + P_{L110} + P_{L15} + P_{L0.4}, \quad (2)$$

where: $P_{CG400,220}$, P_{DG110} , P_{DG15} , $P_{DG0.4}$ are values of generated power in the particular level of voltage, $P_{L400,220}$, P_{L110} , P_{L15} , $P_{L0.4}$ are the power of load in the particular level of voltage.

Equation (1) can be divided by P_G , while equation (2) by P_L :

$$k_{CG400,220} + k_{DG110} + k_{DG15} + k_{DG0.4} = 1, \quad (3)$$

$$k_{L400,220} + k_{L110} + k_{L15} + k_{L0.4} = 1, \quad (4)$$

where: $k_{CG400,220}$, k_{DG110} , k_{DG15} , $k_{DG0.4}$ are coefficients of power participation in generation by sources on the particular level, $k_{L400,220}$, k_{L110} , k_{L15} , $k_{L0.4}$ are coefficients of power participation in load on the particular level.

Values of particular coefficients determine the power flows (currents) in particular lines, but they must be exactly explained. On the one hand, the actual structure of generation depends on the wind and the sun, but there are other factors, such as the actual load, the parameters of conductors, economic factors and laws of nature. The structure of EPS from Fig. 1 is created by lines of different voltage and length. The total length of lines l in the power system of a country like Poland is above 800 000 km [12].

In the case of an extremely centralized EPS ($k_{CG400,220} = 1$), with one large electric power station, or generation center, all the lines are used for the transmission of electrical energy. The burden rate of particular lines depends on actual power (current) flows. The entire generated power $P_{CG400,220} = P_L$ flows from 400 kV and 220 kV lines to 110 kV lines, 15 kV and 0.4 kV lines. Present powers flowing in 110 kV (P_{110}), 15 kV (P_{15}) and 0.4 kV ($P_{0.4}$) lines are:

$$P_{110} = P_{CG400,220} - P_{L400,220}, \quad (5)$$

$$P_{15} = P_{110} - P_{L110}, \quad (6)$$

$$P_{0.4} = P_{15} - P_{L15}, \quad (7)$$

and, of course, $P_{0.4} = P_{L0.4}$. In this case, the natural environment is exposed to EF (the exposition to EF is approximately independent of the load) and to MF, the latter being the function of currents in particular lines.

In the case of an extremely distributed EPS with sources of electrical energy directly connected to all consumers, all the currents caused by the load in the power system are equal to zero. Only the capacitive currents of lines are present. In such case, the natural environment is exposed only to EF, because MF intensity is very low.

In the case of a mixed structure of EPS (the most realistic option) with large power stations (CG) and distributed generation (DG), the power flows (currents) depend on the present relation-

ships between $k_{CG400,220}$, k_{DG110} , k_{DG15} , $k_{DG0.4}$ and $k_{L400,220}$, k_{L110} , k_{L15} , $k_{L0.4}$. The structure of load P_L is largely independent of the structure of generation. In Polish EPS, the highest consumption of energy occurs in low voltage (0.4 kV) networks. Therefore, the most probable structure of load is as follows [12]: $k_{L400,220} + k_{L110} \approx 0.21$, $k_{L15} \approx 0.34$, $k_{L0.4} \approx 0.45$.

The current structure of generation (installed power) in Poland is presently different: $k_{CG400,220} + k_{DG110} > 0.80$, $k_{DG0.4} + k_{DG15} < 0.20$.

It is very difficult to estimate exposure of the natural environment to MF without calculating MF intensity near power lines in the present conditions.

There are two possibilities. The first one is based on mathematical analysis. There are many methods of power-flow analysis, for example: Gauss-Seidel Method, Newton-Raphson Method, Ward-Hale Method and Stott Method. The data must contain information on the impedances and admittances of lines. The present power of all consumers determines the power of generation according to (1) and (2). There are also other requirements, for example: permissible range of voltage, current-carrying capacity of lines, variable transformation ratio. Results of such calculations can estimate the currents in each line. Using the results from Figs. 4, 5, 6 and 7, as well as the results of calculations, it is possible to estimate exposure of natural environment to 50 Hz EF and MF.

In order to compare exposure to EF and MF, the volumetric energy density of EF and MF are used, as well as their sum W :

$$W'_H = \frac{\mu_0 H^2}{2}, \quad W'_E = \frac{\epsilon_0 E^2}{2}, \quad W = W'_E + W'_H. \quad (8)$$

The second method is more useful, because it allows to estimate EF intensity and MF intensity using present information from EPS. Figure 8 presents the principle of operation of the device for Monitoring of Electromagnetic Field (MEMF).

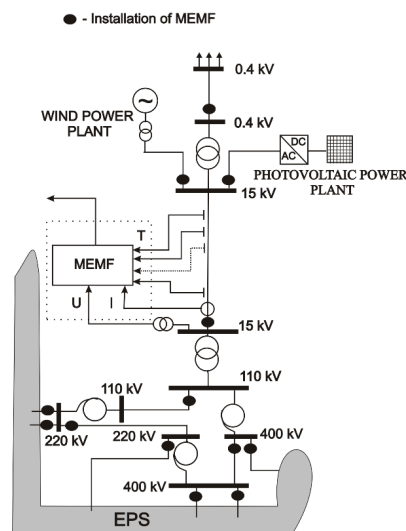

Fig. 8. Device used for estimating exposure of natural environment to 50 Hz EF and MF

Measuring the currents in the wires enables to estimate MF intensity, while measuring the voltage (U) allows for additional precise calculation of EF intensity. Additional measurement of the temperature of the wires (T) allows to calculate the actual sagging. This information allows to correct the configuration of lines from Table 1.

The results of calculations of EF and MF intensities can be sent to a central office for monitoring of electromagnetic field exposure on the natural environment.

5. Conclusions

The analysis shows that exposure to a 50 Hz EF does not partially depend on the present participation of DG and CG in the total generation.

The exposure to a 50 Hz MF depends on the present participation of DG and CG in the total generation.

The proposed device for the Monitoring of Electromagnetic Field (MEMF) allows to estimate the exact exposure to 50 Hz EF and MF.

Additionally, MEMF enables the utilization of the current-carrying capacity of overhead lines, which may be much higher than the values presented in Table 2.

References

- [1] Krajewski W., *Analysis of electric and magnetic fields around a lineman during live working*, *Electrical Review*, 83(9): 57-59 (2007).
- [2] Wróblewski Z., Habrych M., *Electromagnetic field distribution under high voltage lines depending on geometrical systems of phase conductors on pillar*, *Electrical Review* 81(6): 15-19 (2005).
- [3] Krajewski W., *Boundary and line elements in the analysis of selected EMC problems of low frequency*, *Proceedings of Electrotechnical Institute, Warszawa, LII, Zeszyt 224* (2005).
- [4] Bednarek K., Nawrowski R., Tomczewski A., *Analysis of electric field distribution in optimization of three-phase heavy-current busways operating in plane arrangement*, *Electrical Review* 82(12): 49-52 (2005).
- [5] Budnik K., Machczyński W., *Contribution to studies on calculation of the magnetic field under power lines*, *European Transactions on Electrical Power* 16: 345-364 (2006).
- [6] Regulation issued by Minister of the Environment on 30th of October 2003 on permissible levels of electromagnetic fields in the environment and the ways of their restricting (in Polish), *Polish Journal of Laws* 192, pos. 1883 (2003)
- [7] Groszko M., *Polish regulation on maximum admissible intensities for electric and magnetic frequencies of 50 Hz and the European Union recommendations for electrical power engineering*, *Medycyna Pracy* 54(2): 175-179 (2003).
- [8] *Power transmission lines and substations in human environment* (in Polish), PSE-Operator, Warszawa 2009.
- [9] Zeńczak M., *50 Hz electric and magnetic field under distributed and centralized generation* (in Polish), *Wiadomości Elektrotechniczne*, LXXXII (12): 27-29 (2014).
- [10] Grobicki J., Fermata M., *Power conductors and cables* (in Polish), WN-T (2010).
- [11] Siwy E., Żmuda K., *Intensification of the network using in the distribution*, *Electrical Review* 85(3): 243-246 (2009).
- [12] <http://www.ptpiree.pl>, accessed May 2015.