

# Mobile MPLS-TP – Support the mobility of terminal devices using OAM channel

Marcin M. Pijanka and Grzegorz W. Róžański

**Abstract**— MPLS architecture for transport networks play the significant role in the development of next generation networks, in particular with regard to the guarantee of continuity of communications "end-to-end" through a variety of heterogeneous segments of the telecommunications network. The article presents the concept of Mobile MPLS-TP with the use of OAM channels to support the mobility of users and optimize "Handoff" procedure in a hierarchical network topology.

**Keywords**—telecommunications, network protocols, NGN, MPLS, OAM, mobility management, handoff

## I. INTRODUCTION

INCREASING usage of packet-switching (IP protocol) for different types of network services (especially for broadband) instead of classic solutions based on links commutation has a significant impact on the development of telecommunication networks. Increasing customer demands of scope extension of services provided by operators stimulate the evolution of communication techniques for next-generation networks (NGN). It also causes the need of continuous development of mechanisms oriented on ensuring the quality of services and mobility. These trends are especially visible in case of services applied in wireless networks, e.g. the introduction of VoLTE (Voice over LTE) standard shows how important is providing a guarantee of continuous end-to-end communication, including an appropriate QoS (Quality of Service) for packet data (in particular for voice and video).

There are various solutions of data transfer in IP-based telecommunications networks. One of solutions meeting the above requirements is MPLS (Multiprotocol Label Switching), wherein the routing of packets has been replaced by the labels switching. In addition, the functionality of MPLS technology offers additional enhancements like reservations of required bandwidth, QoS guarantee, failures detection and prevention of their negative effects (using mechanisms for OAM). MPLS was developed by the IETF (Internet Engineering Task Force), primarily for backbone (core) networks. Fig. 1 shows the basic components of MPLS backbone network.

The base of this solution is the implementation of mechanisms and procedures related to the creation of virtual connections between two boundary devices - LER nodes (routers) located on the edge of backbone network. These devices are

responsible for QoS ensuring and distribution of labels to all network components along the designated virtual connection (LSP tunnels).

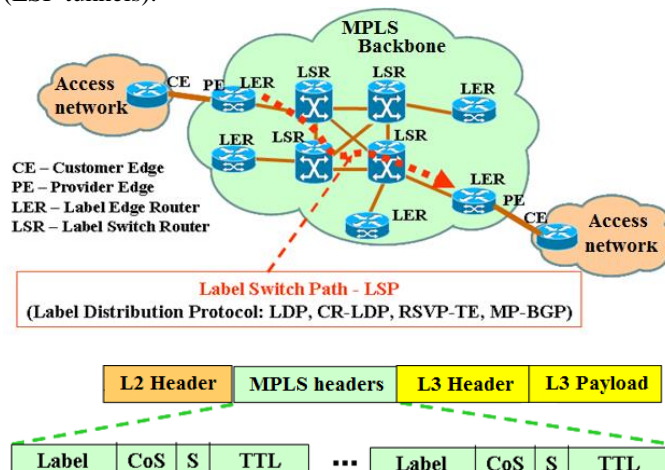

Fig. 1. MPLS Backbone network.

Packages "routed" in the same way are classified in LERs into the appropriate class called FEC (Forwarding Equivalence Class). The task of internal nodes (routers) in MPLS domain called LSR is to ensure that the designated path or "tunnel" is created and switching the transmitted data units according to entries in their routing tables of labels. MPLS is based on algorithms (routing protocols) typical for "network" layer however at the same time it uses the procedure of labels replacement ("Label-Swapping Forwarding Algorithm") characteristic for solutions of the "data link" layer, e.g. ATM technology. MPLS introduces the "Labels" (additional header or headers injected between the headers of the "network layer" and the "data link" layer) to mark the data units and create the virtual LSP path in the core network with the possibility of using the aggregation "tunnels". To create the LSPs in the network we can apply standard LDP protocol or its enhanced version CR-LDP. RSVP-TE or MP-iBGP can also supports MPLS.

MPLS as a part of the connection-oriented communications solutions, with the use of virtualization in the network can also cooperate with the access networks based on Ethernet, FR or ATM – ATOM Architectures (Any Transport over MPLS). Nowadays the ATM technology is increasingly being replaced by MPLS technology because of its superior implementation properties. Furthermore carried out in 2006 by the ITU and IETF standardization processes has led to a further expanded version of the MPLS T-MPLS [1], [2] and finally MPLS-TP [3] with the properties optimized for transport networks (including additional mechanisms of type OAM) – Fig. 2.

Marcin M. Pijanka is with Institute of Telecommunications, Military University of Technology in Warsaw, ul. gen. Sylwestra Kaliskiego 2, 00-908 Warszawa 49 (e-mail: marcin.pijanka@wat.edu.pl).

Grzegorz W. Róžański is with Institute of Telecommunications, Military University of Technology in Warsaw, ul. gen. Sylwestra Kaliskiego 2, 00-908 Warszawa 49 (e-mail: grzegorz.rozanski@wat.edu.pl).

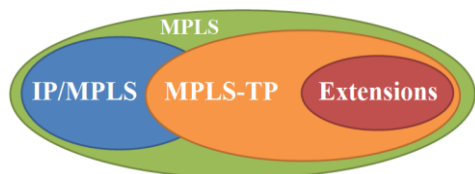

Fig. 2. MPLS-TP solution.

"Extensions" element presented in the above figure includes the additional functionalities of MPLS-TP technology in the field of:

- Management – by both: the NMS (Network Management System) and by the control plane, allowing for static configuration of the paths and support of traffic engineering,
- Reliability – introducing LSP protection for providing switching from affected to protection path in less than 50ms based on diagnostic broadcast shared in network automatically.
- OAM mechanisms - use in-band control channels, providing continuous monitoring and verification of network performance to meet expected service quality (SLA).

A key role in the MPLS-TP plays the adjustment of MPLS functionality technology in respect to heterogeneous communication technologies (Ethernet, ATM, TDM, ...) commonly used in access networks. The variety of communication techniques and the aggregation of traffic flows requires a different approach with the implementation of MPLS-TP technology in networks (e.g. the introduction of the "pseudo-links", static configured paths, etc.). The important advantage is fact the both solutions: IP/MPLS and MPLS-TP is their compatibility.

Currently, the telecommunication service providers gradually modernize their network infrastructures in order to permit fast transport of large amounts of data with minimal cost of implementation and maintenance. Many of the backbone and core networks are based on MPLS technology, which provides the scalability with minimal maintenance activities by the administrators [4]. The target is also to use MPLS-TP solutions in access networks, also in co-operation with heterogeneous wireless systems (LTE, WiFi, WiMax).

Consequently, the more significant problem seems to be the integration of networks using different implementations of MPLS technology and providing "end-to-end" communication support (from the sender to the recipient) using OAM mechanisms. This situation complicates the problem of heterogeneity of networks and multiple ways of using OAM mechanisms.

## II. MOBILE MPLS

Numerous advantages of MPLS technology have contributed to the growth of its popularity not only in backbone networks but also segments of aggregation and access. Due to this fact the new problem appeared - the mobility of the end devices including issues concerning the location management and "handoff" handling – Fig. 3. "Handoff" (also called "handover") is real time switching process of mobile device

from area supported by one base station to area subordinated by another one with keeping the connection in active state.

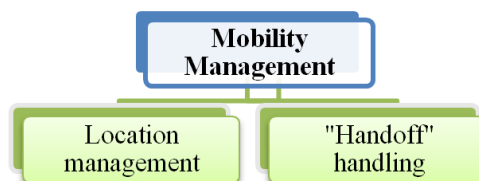

Fig. 3. MPLS Backbone network.

The technology fulfilling these needs is Mobile MPLS, which is based on algorithms used in Mobile IP, except that classic routing of packets-angles on the basis of the IP header which was replaced with switching over the labels.

Same as Mobile IP, the Mobile MPLS introduces additional components (Fig. 4):

- FA (Foreign Agent) – element of the network infrastructure not being the part of the home network but currently supporting the mobile device MN (Mobile Node),
- COA (Care-Of-Address) - a temporary address assigned to the device MN supported by the FA,
- HA (Home Agent) - element of the home network infrastructure responsible for transferring traffic from/to the mobile device thought the FA ,
- CN (Corresponded Node) - element of the network infrastructure exchanging data with MN – it does not have information about the current location of MN and the COA.

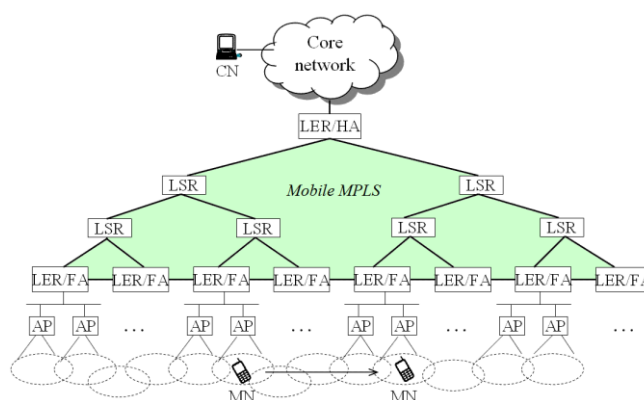

Fig. 4. Mobile MPLS architecture [5].

The connection between any CN and MN is set up via the HA which is responsible for monitoring the current location of the MN and the intermediation in traffic redirection. LER and LSR routers keep appropriate routing tables and tables of labels basing on which the flow of users' data is controlled. These are stored in two databases:

- LFIB (Label Forwarding Information Base) - a database that specifies the way the router redirects incoming packet by MPLS label.
- FIB (Forwarding Information Base) - a database defining how to redirect incoming IP packet based on the destination IP address.

Handoff process, described in detail in [6] consist of series of steps oriented to reconfiguration of connection between HA and MN in order to ensure the continuity of data transmission.

According to the basic assumptions of Mobile MPLS when MN loose the connection with the current FA (or face up with degradation of its quality), it should terminate the ongoing transmission, then establish connection with new FA and through it start full registration procedure to HA again. The initiation phase is based on classic IP routing. However in subsequent steps the HA receiving the registration request from the MN, initiates establishing a new LSP path. User data transmission is possible only after the exchange the necessary signaling messages (requests and confirmations) and broadcast of routing information and signaling for a new path LSP to all nodes through which it passes.

Mobile MPLS technique generally supports the mobility of end device (MN), however, it has several disadvantages:

- temporary interruption of transmission (from the degradation of the connection quality till the end of re-registration procedure in new location)
- Data loss (during the transmission gap)
- Delays
- A large amount of signaling data (exchange of information between HA and FA located in different sub-networks).

These issues contributed to the continuation of work focused on further Mobile MPLS technology improvements - such conceptual solutions are known as "Optimized Mobile MPLS" [7]. The examples of proposed improvements are:

- speeding up the registration process by sending signaling protocol messages using the LDP instead of the classical IP routing,
- implementation of mechanisms known from other existing solutions (e.g. Hierarchical MIP, Cellular IP, HAWAII)
- modification of the MPLS standard by adding extra fields in the MPLS in order to carry the LSP configuration information LSP and its maintenance [7]
- Possibility to use in networks with hierarchical organization.

### III. CONCEPT OF MOBILE MPLS-TP

The evolution of MPLS technology, trends in its implementation and the requirements for next generation networks including end devices mobility, has stimulated the development of Mobile MPLS-TP concept, combining classic Mobile MPLS with additional OAM functionalities proposed for MPLS-TP. This solution allows for combining many of the advantages and capabilities of MPLS-TP technology support the end device mobility at the same time.

Fig. 5 shows the different types of mobility and "handoff" procedure depending on the switching scope in a hierarchical network topology. The proposed concept of Mobile MPLS-TP is a new improved solution that could eliminate or at least reduce the disadvantages of classic Mobile MPLS mentioned in previous part of this article.

The proposed concept of Mobile MPLS-TP is a new improved solution that could eliminate or at least reduce the disadvantages of classic Mobile MPLS mentioned in previous part of this article. When developing the concept for the model of "micro-mobile" (handoffs in the area of a single domain) we proposed the use of two mechanisms:

- Initial setup of LSPs - the process based on a new path establishment before the "handoff" resulting in minimizing the interruption time in data transmission [8],
- low-level handling of "handoffs" performed by active LSR routers - a concept introduces the enhanced features in typical LSR switching routers in order to provide "handoff" handling functions.

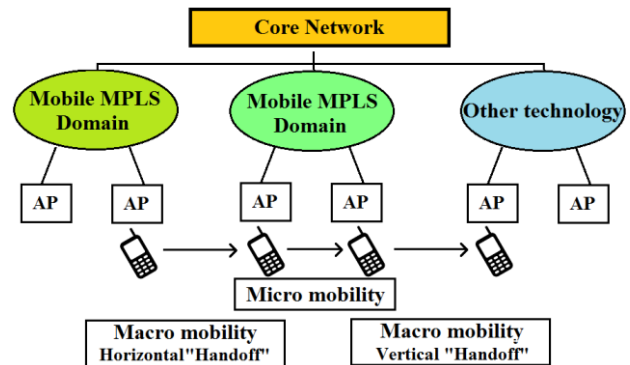

Fig. 5. Types of mobility.

We also defines two fundamental issues to be resolved:

- the development of mobility management algorithms using MPLS OAM channel-TP
- the use of dedicated signaling messages:
- The definition of their optimal structure for example: TLV (Type-Length-Value), FV (Field-Value) or with fields of predefined length
- the clarification of information they conveyed, for example. ID of the current FA, IDs of neighboring FA, power of radio signals, etc.
- the specification how they are transferred in OAM channel

Finally we took two basic assumptions:

- Use the hierarchical organization of the network (considering the role of aggregation segment in the network - the area in which the most commonly we experience the need of mobility support usual – we assumed that hierarchical structure shall be optimal)
- the introduction of decentralized databases (in the case of mobility management, as well as the quality of services, important issue is the problem of storage of information about the parameters of current connections).

To each edge router (LER) suitable numeric identifier (ID) shall be assigned. It is responsible for specifying its location and levels of hierarchy (Fig. 6).

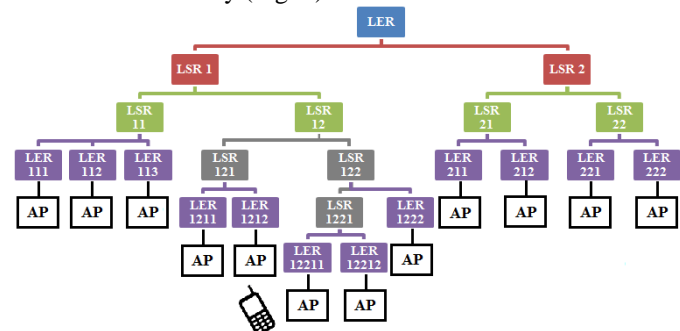

Fig. 6. Hierarchical structure of Mobile MPLS-TP network.

Introduction of such organization and numbering of active LER allows LSR routers to perform the appropriate operations without detailed "knowledge" of network infrastructure.

The first new feature introduced in Mobile MPLS-TP is the use of OAM channels, which are an integral part of the standard MPLS-TP dedicated for carrying of data signaling related to the stability of can-end device. In order to meet the general preconditions of the proposed algorithm (described in next part) we assumed that every router LER should support all features characteristic for MEP (Maintenance End Points) in area of generation and reception of the OAM message.

#### IV. OAM MPLS-TP

OAM messages in the MPLS network are distributed by "in-band" logical channels. In the case of MPLS-TP the OAM messages are sent through the channel called G-ACh (Generic Associated Channel) directly associated with the LSP. Both user data and OAM messages are sent by same paths, however they are logically separated by the use of dedicated labels called GAL (G-Ach Alert Label).

The OAM unit contains of (Fig. 7):

- LSP/tunnel header determining the packet transmission path package in in MPLS-TP domain
- OAM channel header containing a GAL label which value is set to "13"(ITU-T). This header is always at the end of the labels' stack therefore S-bit value must be "1".
- ACh (Associated Channel) header
- OAM message OAM (Fig. 8).

<u>LSP Header</u>	<u>LSP Label</u>		<u>Exp</u>	<u>S (0)</u>	<u>TTL</u>
<u>OAM channel header</u>	<u>GAL Label (13)</u>		<u>Exp</u>	<u>S (1)</u>	<u>TTL (1)</u>
<u>ACh header</u>	<u>0001</u>	<u>Version</u>	<u>Reserved</u>	<u>Channel type</u>	
<u>OAM message</u>	<u>OAM Message</u>				

Fig. 7. OAM MPLS-TP according to IETF [9].

0	0	0	1	Version	0	0	0	0	0	0	0	0	OAM channel type (ITU-T G.8013)
MEL (111)		Version	OpCode									Flags	TTL length
OAM Message data													
TLV end													

Fig. 8. OAM message structure according to IETF [9].

The publication of ITU-T [10] which describes the functionality of MPLS-TP OAM mechanisms-TP does not

include the end device mobility issues, however it specifies the ways to categorize OAM messages by the usage of field OpCode. Its length of 7 bits which allows us to define 127 (27) different types of messages. Currently available OAM mechanisms e.g. LSP continuity monitoring (LSP ping), failure locating (LSP trace-route), rate measurements use only a few of possible set of OpCode values (refer to table below). Values of 48 and 49 have been reserved for experimental purposes (EXM, EXR) and the values of 51 and 50 (VSM, VSR) to be implemented by manufacturers of network components.

Therefore by "49" and "48" OpCode values we can freely compose new OAM messages, dedicated for supporting the end device mobility. The only necessary condition seems to be the application of new functionalities in MPLS routers (LER and LSR), which will allow these devices to interpret the OAM messages.

TABLE 1  
 OPCode VALUES ACCORDING TO ITU-T [10]

OpCode value	OAM PDU type	MIP or MEP
1	CCM	MEP
3	LBM	MIP and MEP
2	LBR	MIP and MEP
33	AIS	MEP
35	LCK	MEP
37	TST	MEP
39	APS	MEP
43	LMM	MEP
42	LMR	MEP
45	IDM	MEP
47	DMM	MEP
46	DMR	MEP
49	EXM	-
48	EXR	-
51	VSM	-
50	VSR	-

#### V. MOBILE MPLS-TP "HANDOFF"

Another proposal under the concept of Mobile MPLS-TP refers to optimized "hand-off" procedure - keeping the connection active despite the change of the mobile device location. In contrast to the approach adopted in the classical Mobile MPLS, there is no need to re-establish the full path between the HA and the MN (re-registration procedure) whenever mobile device change its CA. According to the conceptual assumptions, reconfiguration of LSP in limited area can resolve this problem and provide better efficiency. For this purpose the usage of TTL (Time To Live) field present in MPLS header was suggested. This field describes how many consecutive nodes should transfer the packet before its validity period expires.

Considering the "handoff" from LER ID1 = 1212 to LER about ID2 = 12211 (Fig. 9) as an example, we calculate the value "handoff level" variable: *handoff Level* = max (the number of digits in the LERs' IDs after deletion of common first digits -starting from the left)

In the analyzed example ID1=1212 and ID2=12211, the sequence of common digits from the left side is "12". Remained 3 digits determines the handoff level value (handoff Level = 3).

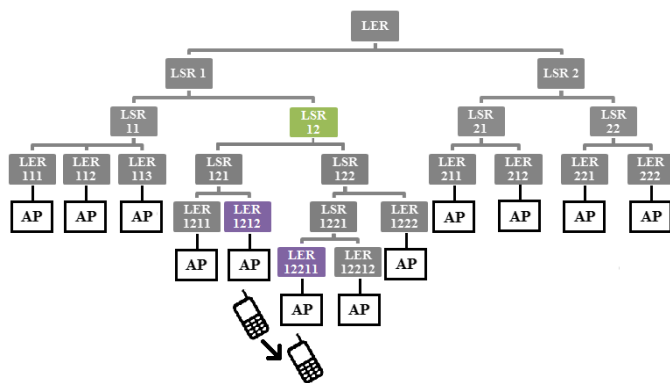

Fig. 9. Handoff” process in Mobile MPLS-TP (micro mobility).

Depending on the calculated value of the hand off Level we may encounter with 3 possible scenarios:

- *handoff Level = 0*,  $TTL = max$  – full reconfiguration of LSP is required. It corresponds to Mobile MPLs solution.
- *handoff Level = 1* - means that there are two LER routers have common “parent” LSR. In that case it is needed to calculate another variable:  $deltaID = ID1-ID2$ 
  - $deltaID = 1$  - means that the two LER routers are neighbors located next to each other. In such situation specific “handoff” called “local anchoring” is possible (Fig. 10) – is based on elongation of the LSP path by one node. Its benefit is the short timing of processing.

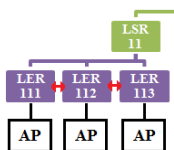

Fig. 10.Local anchoring.

- $deltaID > 1$  - means that the two routers are not neighbors but they are located close to each other. In this case there are two options: basic one which is “handoff” handled by parent LSR (*handoff Level = 1*) or optional which is “local anchoring” with more than 1 node LSP elongation.
- *handoff Level > 1* - means that two LERs are located in separate branches of hierarchical network “tree”. Handoff will be performed by LSR.
  - $ID2 \leq ID1$ :  $TTL = handoff Level - 1$
  - $ID2 > ID1$ :  $TTL = handoff Level - 1 - [length(ID2) - length(ID1)]$

Example calculations results for example “handoffs” performed in hierarchical network are presented in table:

THE EXAMPLES OF “HANDOFF” PROCESSES					
Current LER	Destina-tion LER	Hand-off Level	Delta ID	TTL	Handoff
LER 111	LER 112	1	1	-	Local anchoring possible
LER 111	LER 113	1	1	0	Handled by LSR11
LER 113	LER 12211	1	1	1	Handled by LSR1
LER 12211	LER 113	1	1	3	Handled by LSR1

According to above explanation, LER does not need to know the destination address of the LSR responsible for “handoff” handling. The signaling packet is sent in the same manner as all other data from the MN to the HA., however its TTL value reaches “0” is in a suitable node (LSR) which should manage the handoff process.

Assuming that the each router LER has a table mapping IDs of their neighboring nodes with their (fixed) IP addresses, they may communicate for example in the case of local anchoring handoff. MN periodically (T time interval) sends to LER information about visible base stations. This message must contain both the station ID as the level of the received signal. LER records these information in the registry for *m* strongest stations (n measurements for each). For each supported mobile device, LER acting FA periodically updates the average power of radio signal received by the MN according to the formula:  $Signal(m) = [(sum\ of\ the\ n-1\ previous\ measurements) + (Current\ measurement)] / n$ .

When the value of the received signal level for neighboring stations exceeds the value for the current station, LER initiates the “handoff” process.

The above formula is the only simplified solution. The value of *m* and *T* should be specified by taking into account the density of the radio stations in the individual character of the area. On the other hand, the value of *n* gives as the weight of current measure with respect to previous one. Too low value of *m* would cause too frequent handoffs process, unfortunately too high can cause strong degradation of data transmission before handoff will be initiated. The detailed analysis of optimal selection criteria for the initiation of the “handoff” process can be found in [11].

The following steps in the process “handoff” Mobile MPLS-TP are described below:

1. LER (FA1) supporting MN sends “handoff” initialization request to proper LSR (determined by Handoff Level) giving the ID of the new (destination) LER (FA2)
2. LSR finds in its LFIB and FIB databases the entries responsible for routing user data to the MN identified by its temporary IP address, then it removes the outgoing labels in LFIB.
3. LSR begins buffering user data till receiving the information about the new MN location (its updated IP address).
4. LSR confirms the initialization process by sending an appropriate message to the current LER (FA1).
5. LER (FA1) send to the MN the re-connection initialization request to a new area specifying the ID of the new LER (FA2).
6. MN sends to the new LER (FA2) request the reserve a new IP address.
7. In response the new LER (FA2) returns allocated IP address.
8. MN sends to the current LER (FA1) information about reserved IP address.
9. The current LER (FA1) forwards this information to managing LSR then sends a re-connection request to the MN. LSR router updates the address of the MN in its FIB table.
10. MN performs switching from FA1 to FA2

11. New LER (FA2) distributes information about the availability of a new IP address and associated label (through the LDP protocol) which should be delivered to all upstream LSR routers forwarding any data to MN.
12. When the information gets to LSR handling the handoff the missing mapping (output label) is stored in its FIB/LFIB tables.
13. The data transfer is resumed. Data from the buffer is sent to the new address by new LSP path.

FIB:		
FEC (target IP address)	Next hop	Outgoing label
121.200.0.1	LSR122	26
122.110.0.1		

LFIB:		
Incoming label	Outgoing label	Next hop
25	26	LSR122

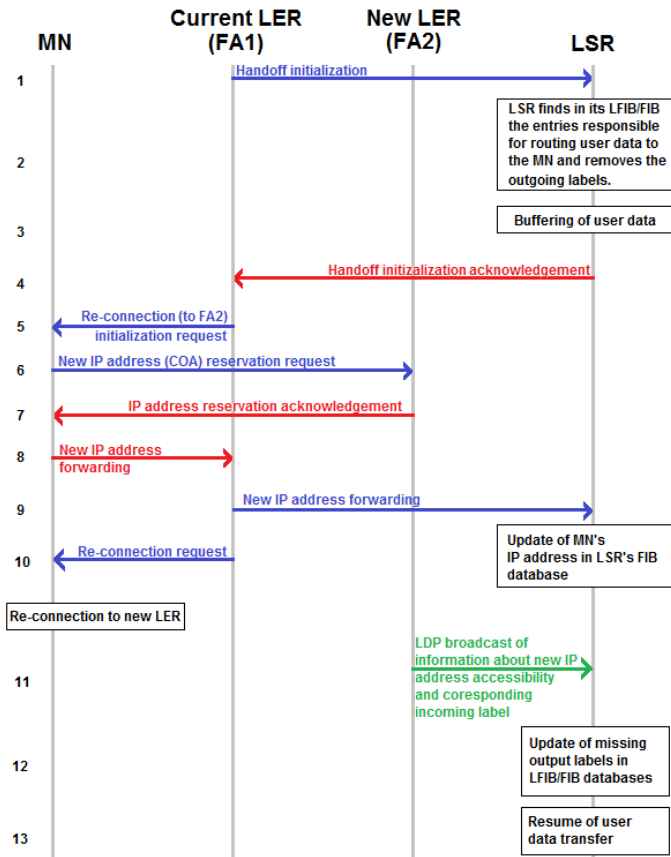

Fig. 11. Signalling diagram of "handoff" realised in Mobile MPLS-TP.

As an example we again consider the "hand-off" presented in Fig. 9:

- MN supported by LER 1212 re-locate to the LER12211
- LER responsible for "hand-off" handling is LSR12
- IP address in current location: 121.200.0.1
- IP address in new location: 122.110.0.1

According to the process, in step 2 LSR12 wipe out the outgoing labels in LFIB and FIB data bases then in step 3 it starts the buffering of user data. In steps 4-10 we have signaling message exchange between four network elements responsible for handoff handling: current LER, new LER, LSR and MN. Finally (steps 11-12) using the exchange protocol labels (eg. LDP) is sent to the information about the availability of a new IP address (assigned to the MN) within the area supported by new LER (new HA). On the basis of LSR12 updated its FIB / LFIB and resume data transmission. First, the transmitted are user data are stored in the buffer.

The usage of this solutions gives us confidence that all handoffs handled at lower hierarchical network levels should be carried out smoothly. Unfortunately the problem is the fact that for LSR routers localized above (in the hierarchical structure) the LSR performing the switch, the process of "handoff" remains "invisible" - routers are not familiar with the updated location (IP address) of the mobile device.

We analyzed two variants to solve this problem:

- Extension of "handoff" procedure with additional broadcast of information about occurred handoff (updated location of the MN and an assigned IP address (CA). Theoretically this information should be delivered to all LSR routers located on the upper levels of hierarchical network. A disadvantage of this concept is a complex signaling, whereas the advantage is the immediate readiness for execution of the next "handoff" process.
- Complement the procedure "handoff" with querying the routers at lower levels or hierarchical network in order to obtain the appropriate IP address mappings (primary address identifying MN ↔ new temporary address indicating the location of MN). The disadvantage is the extra time needed for handoff initiation but we should notice that it does not affect with break in transmission of user data. Querying should take place in the initiation phase of the "handoff" process (before step 2). In contrast, the advantage of this solution is a significant reduction in signaling data.

Bearing in mind that most often the process of "handoff" is carried out between two adjacent base stations (micro mobility), it can be assumed that the procedure of querying routers should occur in limited and relatively narrow area of whole hierarchical network. The second solution therefore seems to be more appropriate.

An example can be a "handoff" process from LER 12211 to LER111. LSR router handling the "handoff" is LSR1. This device receives a "handoff" initiation requests but LER (step 1) is not able to find in its FIB database relevant IP address currently assigned to the MN. Problem happens because this node is not aware of IP address change, which happened during previous "handoff" process. To solve this issue, LSR1 sends a message to all adjacent LSRs in order to inquire about the primary MN's IP address. In this case, the answer should be given by one of two child routers (LSR12) keeping in its FIB table the entry that maps the old and new IP address. More details about this procedure can be found in [12].

### VI. MOBILE MPLS-TP EFFICIENCY

Below table presents the comparison between classic Mobile MPLS and conceptual Mobile MPLS-TP solution.

COMPARISON OF MOBILE MPLS AND MOBILE MPLS-TP ATTRIBUTES		
	Mobile MPLS	Mobile-MPLS-TP
<b>Registration</b>	IP protocol	IP protocol
<b>Handoff</b>	IP protocol	OAM MPLS channels
<b>Handoff scope</b>	Full LSP reconfiguration	Dynamic adaptation of scope by handoff level
<b>Handoff speed</b>	Slow	Various
<b>Delay</b>	Longer	Smaller
<b>Sygnalling</b>	Between MN i HA	Reduced between MN a LSR responsible for handoff handling
<b>Pros</b>	- always optimal LSP	- speed - reduced signalling - reduced user data lost
<b>Cons</b>	- complex signaling - long switching time (full LSP reconfiguration needed) and user data lost	- allocation of two IP addressed to one MN - need of new function implementation to LERS

In order to verify the effectiveness of proposed Mobile MPLS-TP solution (handoff speed, signaling) dedicated tool was developed in the Octave 4.0 environment.

The tool consist of 7 elements: 2 main programs and 5 supporting elements.

STRUCTURE OF MOBILE MPLS-TP TOOL		
Main programs	Program_calc	Program_charts
Supporting elements	Generator	
	Handoff_MPLS	
	HandoffMPLSTP	
	Handofflevel	
	Movement	

“Program\_calc” is the analytical program responsible for calculation of total transmission breaks and signaling load during realization of  $n$  handoffs using classical Mobile MPLS and conceptual Mobile MPLS-TP solutions. “Program\_charts” is responsible for additional calculations of average values and creation of charts comparing the Mobile MPLS and Mobile MPLS-TP technologies. In case of signaling message it was assumed that forwarding of same signaling message for example by 5 subsequent nodes (LERs) is calculated as 5 transmissions.

Input parameters can be classified into two groups:

- Parameters related to the structure of the MPLS network:
  - The number of edge routers (LERs) that can support MN as potential FA,
  - Number of subordinate LSRs connected to parent LSR on higher level of network structure. This parameters defines the number of "branches" in our MPLS network "tree".

- Parameters related to the simulation:
  - Number of handoffs ( $n$ ),
  - Type of traffic class defining the way how mobile device moves: “random” representing user moving in limited area surrounded by multiple cells, “progressive” representing user moving in specific direction,
  - The number of neighborhood base stations surrounding the current MN supporting area. This parameter indirectly reflects the cellular structure of radio network. The parameter value of 3 means that the MN can switch to 6 (-3, -2, -1, 1, 2, 3) of adjacent cells.

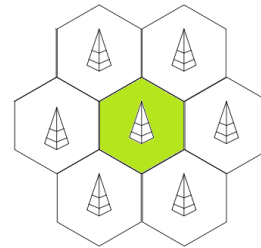

Fig. 12. Mobile network structure

Both main programs use supporting elements. “Generator” is responsible for generation of hierarchical symmetric MPLS network structure meeting the preconditions selected by user. Each LER located at MPLS domain’s edge has suitable ID assigned.

“Movement” is function responsible for the location change of MN. It can simulate two different movement scenarios mentioned before: “random” and “progressive”. Thanks to this function we can consider different environments for testing Mobile MPLS-TP efficiency.

„HandoffMPLS” and „handoffMPLSTP” are responsible for handling the handoff procedure between two LERs. The input data are:

- ID of current LER
- ID of target LER
- ID of LSR performing last handoff (only for Mobile MPLS-TP – this information is needed to take under consideration the delay caused by missing mapping problem described in previous chapter. These two functions are responsible for calculating all needed statistics for single handoff operation (transmission break/full handoff processing time and signaling load). In current implementation these function calculates normalized values. To get the real data (ms) we should introduce the updated parameters inside these functions characteristic for specific network realization:
  - Link delay (IP and MPLS protocol)
  - Switching time (IP and MPLS protocol)
  - Routing tables update time (for IP and MPLS routing protocols)

As same normalized parameters were applied for both: Mobile MPLS and Mobile MPLS-TP handoff calculations, it is possible to assume that results are comparable.

“Handofflevel” function supports „handoffMPLSTP” and it dynamically defines the range of handoff (which LSR located closest to LER can handle the successful switch of LSP path.

To verify the efficiency of Mobile MPLS-TP solution we run the tool with below parameters:

- Number of LERs: 1000
- Number of subordinate LSRs under parent LSR: 3
- Number of handoff's in each iteration:  $n=4$
- Movement type: progressive
- Current mobile cell surrounded by 6 different ones

First chart (Fig.13) shows the average time of transmission break during handoff operation as a function of the LER number. In case of Mobile MPLS we see stepwise changes. These hops are caused by increasing number of network levels – in that case the distance between MN and HA is increased with additional node. In case of Mobile MPLS-TP the values vary however we can see their linear trend.

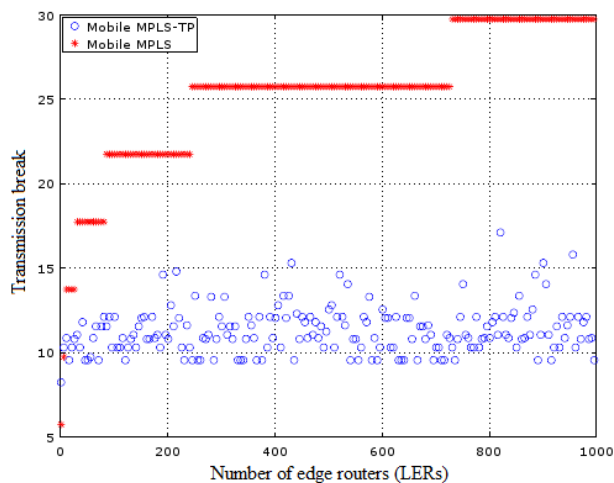

Fig. 13. The average transmission break time as a function of the number of LERs.

Second chart (Fig.14) is based on same input data however it shows the cumulative average transmission breaks in a function of network levels. In case of Mobile MPLS we see the rising linear trend – additional level of LSR routers cause the increased time of signaling exchange process. For Mobile MPLS-TP handoff is handled much faster as there is no need to communicate with distant HA. In case of network with only 4 levels within its hierarchy the transmission break is two times shorter for Mobile MPLS-TP.

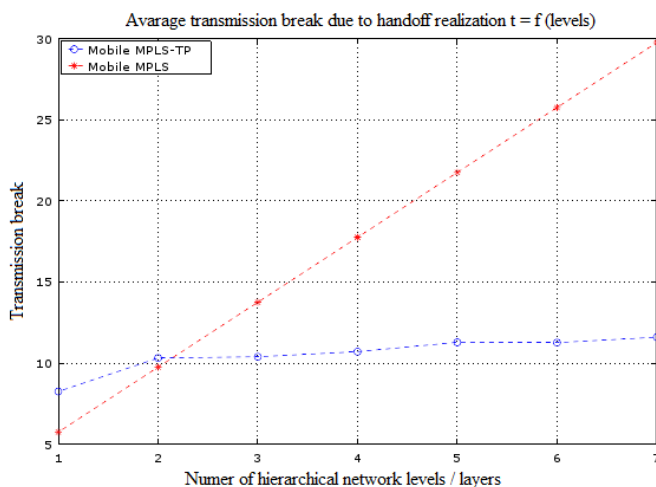

Fig. 14. The average transmission break time as a function of the number of network levels

Fig. 15 and 16 present the number of signaling messages transmissions caused by realization of  $n$  handoffs as a functions of the number of LERs . Same as for previous ones the comparison of Mobile MPLS and Mobile MPLS-TP was done as a function of LER number and number of network levels.

Because the handoff operation in Mobile MPLS-TP is much more complicated process than re-registration in Mobile MPLS, the double reduction of signaling traffic is noticeable in MPLS domain with 6 levels. Although the optimization of signaling cost is slightly worse than optimization of handoff time, still we see the significant benefit related to usage of Mobile MPLS-TP.

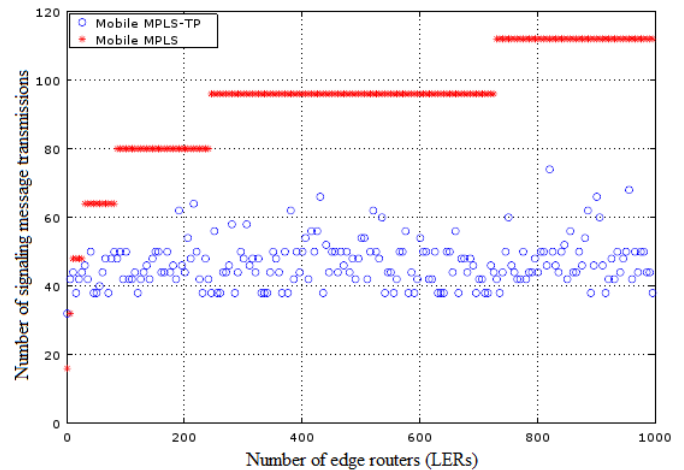

Fig. 15. The number of signalling message transmissions as a function of the number of LERs

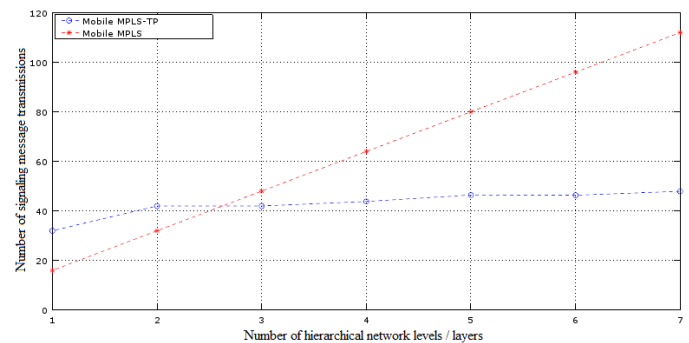

Fig. 16. The number of signalling message transmissions as a function of the number of network levels

## VII. SUMMARY

This article presents the advantages of conceptual Mobile MPLS-TP solution dedicated for access and aggregation networks supporting the mobility of end user. The biggest benefits are achievable in extensive complex networks consisting of high number of LSR and LER routers located in multi-level hierarchical network.

Furthermore implementation of Mobile MPLS-TP does not require significant modifications of current assumptions of MPLS standards (all signaling messages are transmitted by already standardized OAM channels). The usage of OAM channels may bring much more benefits than support of location and “handoff” management what can be desirable issue of further researches.



## REFERENCES

- [1] TPACK, “T-MPLS: A New Route to Carrier Ethernet”, USA, 2006
- [2] ITU-T, “G.8110.1 Architecture of Transport MPLS (T-MPLS) layer network”, Geneva, 2011
- [3] Jupiter Networks, “MPLS Transport Profile (MPLS-TP)”, USA, 2011.
- [4] ECI Telecom, “MPLS-TP AND IP/MPLS their applicability for metro networks”, UK, 2012.
- [5] R. Langar, N. Bouabdallah, S. Tohme, “On the Analysis of Mobility Mechanisms in Micro Mobile MPLS Access Network”, Waterloo, 2006.
- [6] Z. Ren, C. Khong, T. C. Foo, C. Ko, “Integration of Mobile IP and Multi-Protocol Label Switching”, Singapore, 2001.
- [7] S. Wang et al., “Optimized Mobile MPLS”, 2008.
- [8] R. Langar, N. Bouabdallah, R. Boutaba, “A Comprehensive Analysis of Mobility Management in MPLS-Based Wireless Access Network”, Waterloo, 2008.
- [9] IETF M. Bocci et. Al, “RFC 5586 MPLS Generic Associated Channel”, 2009.
- [10] ITU-T, “G.8113.1 Operations, Administration and Maintenance mechanism for MPLS-TP in Packet Transport Network (PTN)”, Geneva, 2012.
- [11] P. Chertchom, “Micro-Mobile MPLS: Performance Analysis and Improvement with RSSI” , *Journal of Communications* vol. 1 no. 6 pp. 76-85, 2012
- [12] M. Pijanka, G. Różański: “Mobile MPLS-TP – wsparcie mobilności urządzeń końcowych z wykorzystaniem kanałów OAM”, *Przegląd Telekomunikacyjny* no 8-9 pp .928-937, 2015, DOI:10.15199/59.2015.8-9.35