



ZHAOXIANG CHU^{*1}, JIANHU JI^{**}, XIJUN ZHANG^{**}, HONGYUAN YAN^{**},
HAOMIN DONG^{**}, JUNJIE LIU^{**}

**DEVELOPMENT OF ZL400 MINE COOLING UNIT USING SEMI-HERMETIC SCREW COMPRESSOR
AND ITS APPLICATION ON LOCAL AIR CONDITIONING IN UNDERGROUND LONG-WALL FACE**

**OPRACOWANIE ZESTAWU CHŁODZĄCEGO ZL400 SKŁADAJĄCEGO SIĘ Z PÓL-HERMETYCZNEJ
SPRĘŻARKI ŚRUBOWEJ I JEGO ZASTOSOWANIE DO KLIMATYZACJI LOKALNEJ W REJONIE
PRZODKA ŚCIANOWEGO**

Aiming at heat injuries occurring in the process of deep coal mining in China, a ZL400 mine-cooling unit employing semi-hermetic screw compressor with a cooling capacity of 400 kW is developed. This paper introduced its operating principle, structural characteristics and technical indexes. By using the self-built testing platform, some parameters for indication of its operation conditions were tested on the ground. The results show that the aforementioned cooling unit is stable in operation: cooling capacity of the unit was 420 kW underground-test conditions, while its COP (coefficient of performance) reached 3.4. To address the issue of heat injuries existing in No. 16305 U-shaped long-wall ventilation face of Jining No. 3 coal mine, a local air conditioning system was developed with ZL400 cooling unit as the system's core. The paper presented an analysis of characteristics of the air current flowing in the air-mixing and cooling mode of ZL400 cooling unit used in air intake way. Through *i-d* patterns we described the process of the airflow treatment, such as cooling, mixing and heating, etc. The cooling system decreased dry bulb temperature on working face by 3°C on average and 3.8°C at most, while lowered the web bulb temperature by 3.6°C on average and 4.8°C at most. At the same time, it reduced relative humidity by 5% on average and 8.6% at most. The field application of the ZL400 cooling unit had gain certain effects in air conditioning and provided support for the solution of mine heat injuries in China in terms of technology and equipment.

Keywords: coalmine; heat injuries; cooling unit; long-wall working face; ventilation and cooling

Aby zapobiec zagrożeniom spowodowanym wysokimi temperaturami panującymi w podziemnych kopalniach w Chinach, zaprojektowano zestaw chłodzący ZL400 składający się z pół-hermetycznej sprężarki śrubowej o wydajności 400 kW. W pracy omówiono zasady działania zestawu chłodzącego, jego budowę oraz parametry techniczne. Przy wykorzystaniu specjalnie do tych celów zbudowanej platformy

* SCHOOL OF MECHANICS & CIVIL ENGINEERING, CHINA UNIVERSITY OF MINING & TECHNOLOGY, XUZHOU 221116
PR CHINA

** CHONGQING RESEARCH INSTITUTE OF CHINA COAL TECHNOLOGY & ENGINEERING GROUP, CHONGQING 400037
PR CHINA

¹ CORRESPONDING AUTHOR: E-MAIL ADDRESS: chulongxiang@163.com

testowej, działanie zestawu zostało szczegółowo zbadane. Wyniki wskazały, że działanie zestawu jest stabilne, wydajność chłodzenia w warunkach testowych pod ziemią wyniosła 420 kW a współczynnik pracy wyniósł 3.4. W celu zapobiegania zagrożeniom spowodowanym przez nadmierne temperatury w rejonie przodka nr 16305 w kształcie litery U w kopalni węgla Jining 3, zaprojektowano układ klimatyzacji, którego głównym elementem jest zestaw chłodzący ZL400. W pracy przedstawiono charakterystyki przepływu strumienia powietrza w strefie mieszania i w strefie chłodzenia dla zestawu chłodzącego umieszczonego w rejonie wlotu powietrza. Analizy przepływu powietrza (chłodzenie, mieszanie, ogrzewania) opisano przy pomocy przebiegów *i-d*. Dzięki układowi chłodzenia obniżono temperatury termometru suchego w rejonie przodka średnio o 3°C, a maksymalnie o 3.8°C, zaś temperatura termometru wilgotnego obniżyła się średnio o 3.6°C, a maksymalnie o 4.8°C. Jednocześnie obniżeniu uległa wilgotność powietrza, średnio o 5%, a maksymalnie o 8.6%. Zastosowanie zestawu chłodzącego ZL400 w warunkach roboczych daje określone efekty i przyczynia się do rozwiązania problemu zagrożeń spowodowanych nadmiernymi temperaturami w kopalniach chińskich poprzez poszukiwania skutecznych technik i sprzętu.

Słowa kluczowe: kopalnia węgla, zagrożenia spowodowane wysokimi temperaturami, przodek ścianowy, wentylacja, chłodzenie

1. Introduction

Coal is the dominant energy of China, and has provided reliable support of energy for the rapid and sustained growth of the national economy. According to the data released by National Bureau of Statistics (NBS), the coal production in China amounted to 3.68 billion tons in 2013 (China Bureau of Statistics, 2014). To secure the energy supply needed by the rapid while sustained development of the national economy and maintain the annual coal production at 4 billion tons., depth of exploitation of coal resources will inevitably increase. The number of coal mines with mining depth exceeding 1,000 meters is 47 in China, and the average mining depth is up to 1,086 meters. Among these, maximum mining depth has already reached 1501 meters in Suncun coal mine, which is owned by Xinwen Mining Group of Shandong Energy. This is also the maximum depth in Asia (Wang & Gao, 2013). During the deep mining, apart from some accidental disasters and threats in local parts such as coal and gas outburst, rock burst, and water bursting, etc., coal mines are generally exposed to heat injuries that has become an important factor restricting the safe mining of deep coal resources (He, 2009).

Not only effect the physical health of workers and reduce labor productivity, high temperature and humidity in coal mines also poses a serious threat to the safe production of coal mines. Although various causes of heat injuries in coal mines exist (ASHRAE, 2007), in China major reasons for the heat in coal mines include heat emission from wall rocks caused by raise of virgin rock temperature when increasing mining depth, and heat dissipation of large electromechanical equipment (Yang et al., 2011). To provide proper working environment for underground working face, traditional non-mechanical cooling methods should be applied at first to alleviate the issue of heat injuries, for example increasing ventilation rate, changing mining method and ventilation mode, etc. Once such traditional way fails to work, mechanical ways of cooling must be taken. Western countries with well-developed mining industries such as US, Germany, Britain, Australia, Poland, South Africa, have researched on air cooling in deep mines, and worked out diverse forms of mechanical cooling systems that have brought good effects. For instance, in US, centralized cooling systems on ground (both cooling and heat dissipation are completed on ground), in underground mines (they are completed in underground mines) and of hybrid usage (cooling completed in underground mines while heat dissipation on ground) are built respectively according to the difference in positions of cooling and heat dissipation for mechanical cooling

systems (Howard, 1997; ASHRAE, 2007). Each cooling system can take several specific forms according to specific conditions. German approach of mine cooling is to construct refrigeration stations with large cooling capacity on ground or in underground mines (Schlotte, 1999). Relying on its developed industrial equipment manufacturing industry, it enhances the cooling capacity of each cooling unit in refrigeration stations as much as possible so as to compensate the cooling losses and discharges the condensation heat generated in the system on ground. As Britain and Australia are independent commonwealth countries, their coal mining methods bear much resemblance: long-wall mining is applied most often, while U-shaped or Y-shaped ventilation is used for working face. Their mine cooling methods, under the influences of those in Germany, consist of separate or gradual cooling air flow through air coolers placed on roadways (including air intake and return roadways) in working face and on ground by chilled water from centralized cooling systems (Anderson, 1988; McPherson, 1993; Mitchell, 2003; Lowndes et al., 2004). Heat injuries, partly resulted from the increase of mining depth, also exist in mines in Poland, which is a major coal producer in Eastern Europe. In early years, mine cooling technology in Poland received strong influences from Germany, however in recent years it developed rapidly. The mainly applied systems are underground centralized air-cooling systems and mobile air-cooling systems. Accessorial equipment is centralized and local cooling devices such as GMC-2000, GMC-1000, TS-300, and TS-450 (Nowak, 2012, 2013; Jerzy, 2013). South Africa is the first on developing mine cooling technologies all over the world and has abundant cooling methods. Since the mines in South Africa are precious metal mines, higher mining costs are affordable. Therefore, the mining depth in the country is large, averaging between 3,000 and 5,000 meters. It has conducted relevant researches on analysis of various heat sources, determination of temperature-lowering load, local air-cooling in mines, centralized cooling on the ground and underground, ice cooling system, related accessorial equipment, and computer simulation software (Vander et al., 1983; JJJ et al., 2006; Gundersen et al., 2006; Wilson, 2008).

At present, the technology and equipment associated with heat injuries in coal mines are basically identical to the above countries. For example, Zhaolou coal mine of Shandong Province uses both water spraying on ground systems and underground centralized cold-water cooling systems in need of different phases; Dingji and Panji coal mines of Anhui Province combines centralized mine cooling heating and power system (CCHP); Sikuang coal mine of Henan Province operated by Pingmei Group employs mobile air conditioning systems for local parts and cooling systems for whole mines using cryogenic refrigerators with heat, electricity and glycol; Sanhejian coal mine of Jiangsu Province deploys HEMS deep mine air-cooling systems, which utilizes mine inflow water as the cooling source (Yang et al., 2011). All these above have gained good cooling effects. However, differs from conditions in countries with developed mining industries, the main issue confronting coal mine cooling in China is the lack of key and core equipment (such as local cooling units, large explosion-proof cooling units, and so on). Regardless of large-size centralized air-cooling systems or small-sizes mobile local air-cooling systems flexible in use, the evolution requires big breakthroughs in such key and core equipment development. Having fully understood of the 4 characteristics in coal mines – high temperature, high humidity, high dust and limited space, we introduced, learned and reinvented world's advanced technologies and equipment. While improve reliability of key equipment, we reduced development costs. In this paper, a ZL400 series of mine cooling units using semi-hermetic screw compressors were developed and applied in practices to reduce heat injuries occurring in the process of deep coal mining in China.

2. The development of ZL400 cooling unit

2.1. The operating principle

Same with ordinary ground-based cooling unit, the operating principle of ZL400 mine cooling unit complete the whole refrigeration cycle with compressor, evaporator, condenser, expansion valve and the circulated refrigerant. Shortly after absorbing excess heat, the gaseous refrigerant is compressed into gas of high temperature and pressure by the compressor, and then transferred to the condenser to be condensed into liquid at 50°C. Heat released thereby is carried away by the circulated cooling water in the condenser. Afterwards, the cooled refrigerant is decompressed and passes through expansion valve into evaporator, where it turns into gas of low temperatures (ranging from 0°C to 10°C), absorbs excess heat from water or air flowing to achieve cooling goals. Such gaseous refrigerant is then transferred to the compressor again, and thereby a closed refrigeration cycle “compression→condensation→throttling→evaporation” is formed. The basic principle is shown in Fig. 1.

A major feature of the ZL400 mine cooling unit is that both cooling and heat discharging processes are completed in underground mines. The cooling unit uses returning air or gushing water in heat discharge. However, to solve the issue that heat medium reaches high temperatures in summer, it is designed as a heat pump unit that operates at high condensing temperature, has large flow capacity, works with small temperature difference, and uses water to carry away heat. It uses R22 as the circulated refrigerant, which is designed to evaporate at 0°C, condensing temperature of 53°C, and work at overheating temperature of 5°C while supercooling temperature of 5°C. Consequently, pressure-enthalpy diagram (lgP-h) of R22 cooling and circulating can be determined, as shown in Fig. 2. According to the physical properties of the refrigerant, parameters corresponding to the status points can then be found and determined, as shown in Table 1.

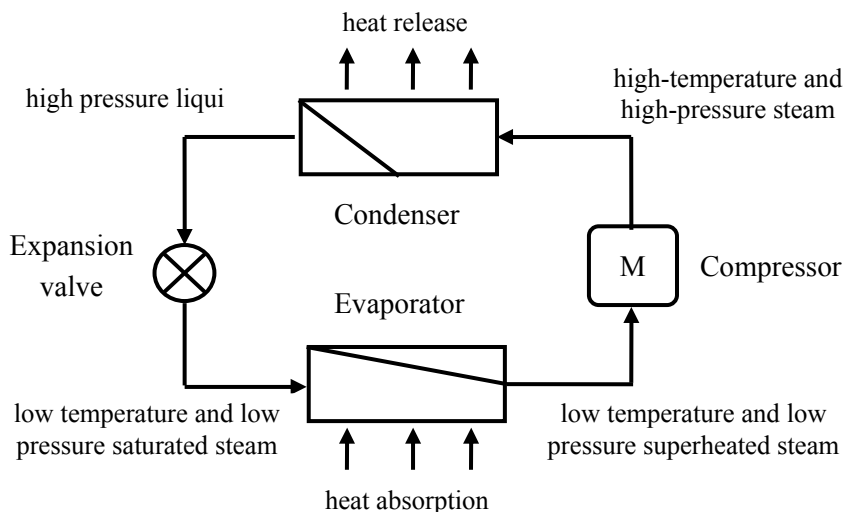

Fig. 1. Diagram of cycle process of compressing and cooling

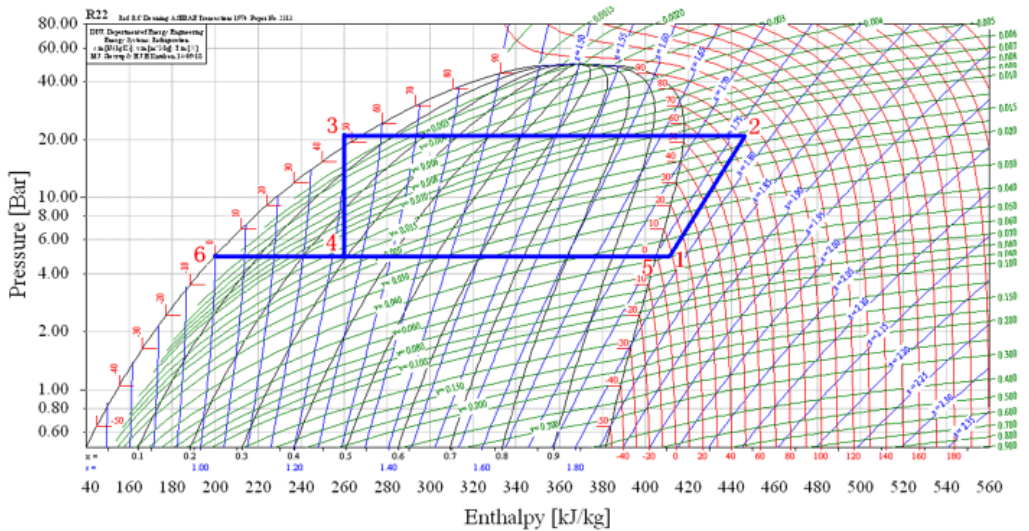

Fig. 2. The pressure-enthalpy diagram (lgP-h) for the refrigeration cycle of R22

TABLE 1

Corresponding parameters of the status points

State Point	Temperature [°C]	Pressure [MPa]	Specific Enthalpy [kJ/kg]	Specific Entropy [kJ/(kg·°C)]
1	5	0.498	408.7247	1.764
2	80.8048	2.0798	445.7817	1.764
3	48	2.0798	260.3639	1.1987
4	0	0.498	260.3639	1.221
5	0	0.498	405.0479	1.7507
6	0	0.498	200	1

2.2. Structure and technical parameters

Body of refrigerator consists of semi-hermetic screw refrigeration compressor machine, shell and tube condenser, thermal expansion valve, filter drier, oil collector and related regulating valve, etc. Small dimension of the whole machine leads to convenience on transporting. Usage of hermetic screw compressor steadies operation and prevents leakage of refrigerant. Full self-protection mechanism enables strong adaptability for complex environment. Design sketch of the ZL400 cooling unit is shown in Fig. 3 while main technical parameters are listed in Table 2.

Local air conditioning systems contained in ZL400 cooling unit can be divided into two categories: direct action refrigeration system where evaporator cools air flow directly and indirect action refrigeration equipment where evaporator cools water supplied to gate road and longwall air coolers. As shown in Fig. 4, The former mainly consists of ZF400 cooling unit, direct cooling evaporator, recoler, monitoring system (such as PLC, etc.) and necessary accessories, while the latter is composed of ZL400 cooling unit, evaporator, air cooler, recoler, monitoring system (such as PLC, etc.) and necessary accessories. The relation between ZL400 cooling unit and accessories is illustrated in Fig. 5.

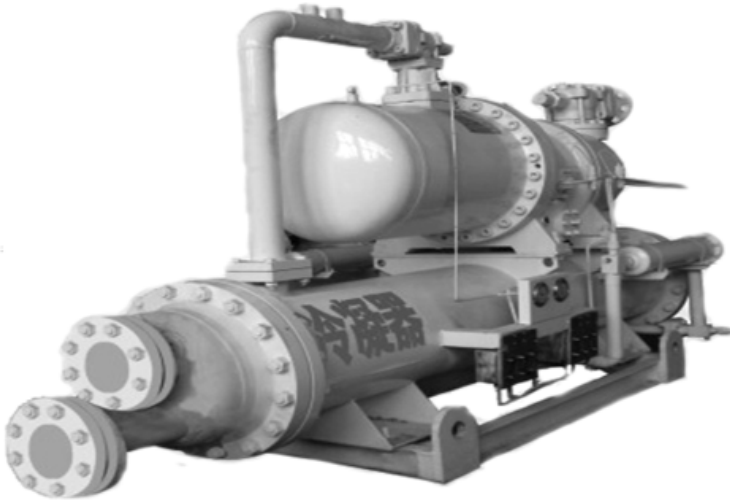

Fig. 3. Design sketch of ZL400 cooling unit

TABLE 2

The main technical parameters of ZL400 refrigeration unit

Technical Indexes		Technical Parameters	
Model of the Unit		ZL400	
Normal Conditions		Evaporating Temperature: 0°C; Condensing Temperature: 53°C	
Cooling Capacity (kW)		400	
Power		660V, 50Hz, 3PH	
Used Refrigerant		R-22	
Refrigerant Charge (kg)		120	
Safety Protection		Pressure Switches, fusible plug, motor reversion, and compressor overheating protection	
Compressor	Type	Semi-hermetic screw	
	Quantity	1	
	Motor Power (kW)	132	
	Starting Mode	Soft start	
Condenser	Type	Closed shell and tube	
	Pressure by Waterside (MPa)	4	
	Water-side Pressure Drop (KPa)	<100	
	Water Inlet Temperature (°C)	42	
	Water Outlet Temperature (°C)	48	
	Water Flow Rate (m ³ /h)	75 (Circulating)	
	Tube Diameter (mm)	DN100	
Dimension	Length (mm)	2750	
	Width (mm)	1000 (Protection net is not included)	
	Height (mm)	1250	
Weight (kg)		1900	

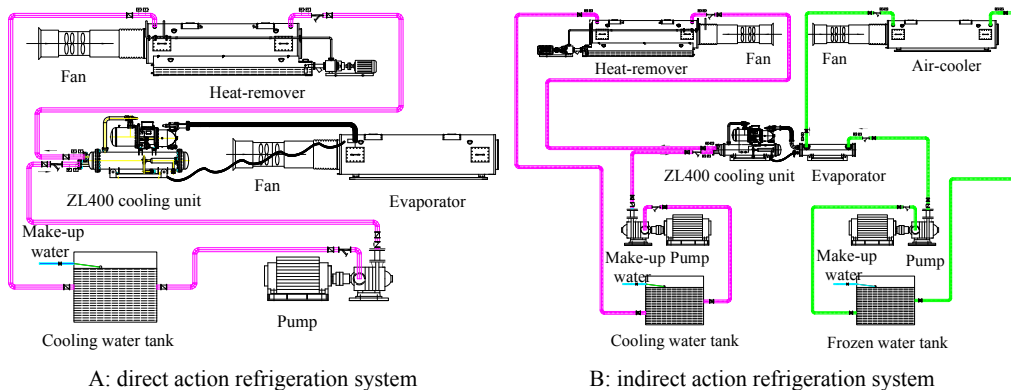

Fig. 4. Direct and indirect action refrigeration system composition with ZL400

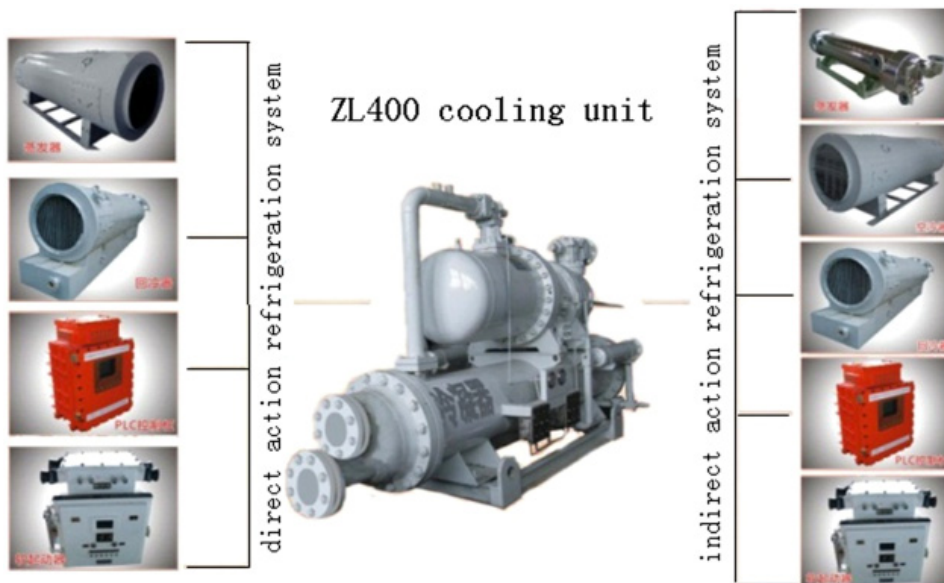

Fig. 5. Relationship between ZL400 cooling unit and the accessories

ZL400 cooling unit has the following features:

- (1) Three of “the 4 components” (the evaporator is excluded) working in the cooling and cycle process of the cooling unit are its major component parts. Since evaporator is separated from its body, its volume decreases, consequently makes it easier to move and install. Moreover, such separation indicates that by equipping with different evaporators, the unit can serve as direct action refrigeration system to cool air flow directly, as well as indirect action refrigeration system to cool refrigerating media such as water, thereby meeting the requirements of different specific conditions.

- (2) Differ from piston compressor, a screw compressor is employed in the cooling unit. As screw compressor is semi-hermetic, problems such as leakage of refrigerant, “liquid hammering” occurring in piston compressors, etc. can be avoided. This is a pioneering work in mine cooling applications over the world.
- (3) Components of the cooling unit – compressor, evaporator and condenser – adopt modular design, therefore can be dismantled and carried into underground mines piece by piece. This is suitable for mines in south of China where heat injuries happen frequently, and also have advantages for large and modern mines in northern China. The unit owns characteristics of small volume, mobile convenience, simple installation, easy operation, flexibility, and good applicability, etc.

2.3. Ground test of performance

To detect performance of ZL400 cooling unit, a detection platform was established on ground, which was primarily used to detect performance of local air conditioning system and complete equipment and factory inspection, as well as providing technical support for technical upgrading of existing equipment and development of novel systems for local air conditioning. The platform has 4 major parts: refrigerating system, data acquisition system, PLC control and protection system, together with power supply and distribution system. It is capable of detecting performance of mine cooling systems with cooling capacity below 500 kW and complete equipment. The platform was mainly used to test stability of operations of cooling unit under different working conditions and cooling effects. Structure and appearance of the detection platform is shown in Fig. 6. Operation conditions of air cooling system, acting as an example here, is detected.

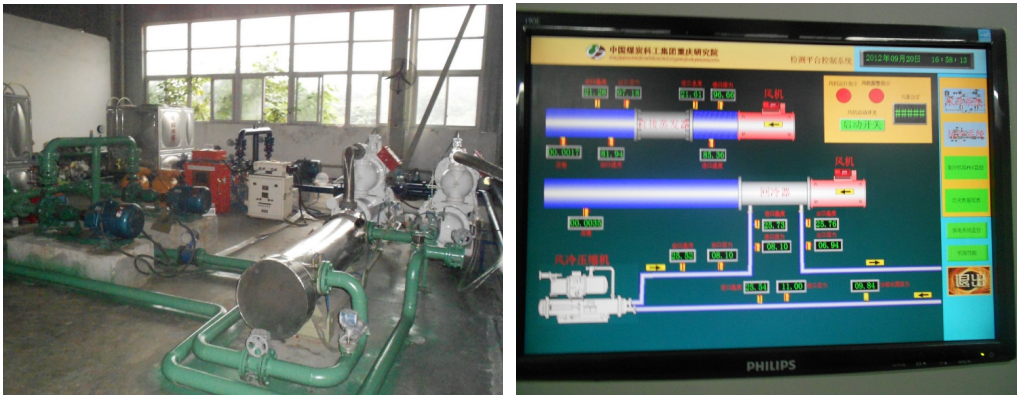

Fig. 6. Pictures of detection platform and data acquisition system

During the test, we adjusted the operation conditions of cooling unit to rated values, measured the inlet temperature of cooling water, the power consumption of compressor, and the actual values of air entering and leaving the evaporator. By using air enthalpy difference method, we performed the calculation according to formula (1) and (2) below. The cooling capacity Q_c :

$$Q = \frac{q_m(h_{a1} - h_{a2})}{V(1+d)} \quad (1)$$

where:

- Q — cooling capacity [kW];
- h_{a1} — entering air enthalpy [kJ/kg(dry air)];
- h_{a2} — leaving air enthalpy [kJ/kg(dry air)];
- q_m — mass velocity of air at the testing point [kg/s];
- d — moisture content at the testing point [kg(water vapor)/kg(dry air)];
- V — specific volume of air at the testing point [m³/kg].

The cooling unit performance COP :

$$cop = \frac{Q}{W} \quad (2)$$

where: W represents motor power, and the measurement unit is kW.

Taken air-cooling unit as example, 5 tests were conducted and the average value was obtained: the cooling capacity of the unit was approximately 420 kW on average, while all of the calculated COPs were above 3.4. All the results are listed in Table 3.

TABLE 3

Test results of the operation of cooling unit (I)

Test number	Entering air temperature [°C]	Entering air humidity [%]	Leaving air temperature [°C]	Leaving air humidity [%]	Air volume [m ³ /s]	Power [kW]
1	33.5	78%	22.1	96%	8.3	122
2	33.6	79%	22.3	97%	8.2	121
3	33.1	83%	22.5	98%	8.4	121
4	32.8	78%	20.8	98%	8.4	122
5	32.6	81%	20.7	98%	8.1	122

TABLE 3

Performance calculations of the cooling unit (II)

Test number	Entering air enthalpy [kJ/kg]	Leaving air enthalpy [kJ/kg]	Specific volume of leaving air [m ³ /kg]	Moisture content [kg/kg] (dry air)	Cooling capacity [kW]	C O P
1	100	63.2	0.859	0.016084	420	3.4
2	101.4	64.4	0.86	0.01646	417	3.4
3	102.3	65.6	0.861	0.016844	423	3.5
4	96.6	59.5	0.854	0.01514	432	3.5
5	98.1	59.7	0.854	0.015207	431	3.5

3. Field application of ZL400 cooling unit in mine

3.1. Project Overview

Jining No. 3 coal mine, owned by Yankuang Group Co. Ltd of Shandong Province, is the first modern vertical shaft mine in China with designed production capacity of 5 million tons. Data of geological exploration shows the depth and temperature of the constant temperature zone are 55 m and 16.5°C respectively, where underground temperature gradient for the whole mine is 2.44°C/100 m and average gradient for coal-bearing strata is 2.96°C/100 m. At present, the mining depth has already reached -630 m level (nearly 700 m from surface to the deepest area), and therefore, heat injuries caused by raise of ground temperature become increasingly prominent. Ambient temperature and humidity of 16302 fully mechanized coal-working face lying in the high temperature zone during production period has been measured, as shown in Fig. 7. Conclusion draws that heat injury issue in the mine is ultimately urgent.

3.2. Calculation of cooling load on working face

Cooling load for mechanical air conditioning on working face is defined as the needed supply of refrigerating output for working face to maintain temperature of working face inlet air below or at 26°C (or 28°C according to *Technical Specifications for Mine Cooling*, MT/T 1136-2011. this paper used 28°C as standard). According to this requirement, main consideration range for cooling design of the working face is the temperature conditions in air inlet ways and along inclines of working face, while conditions in air- return ways is neglected temporarily. As temperature and humidity on airflow course is in a rising tendency, the thermal parameters of airflow at air-returning corner on working face can be treated as critical conditions (for instance, dry-bulb temperature is 28°C and relative humidity is 80% at point C in Fig. 7). The target of cooling working face is to keep the airflow temperature and humidity of the whole working face below level of such conditions.

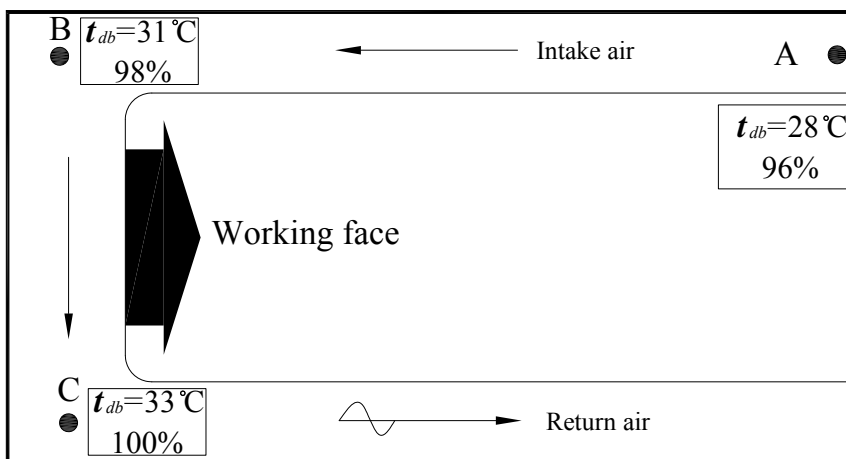

Fig. 7. Key point thermal parameters of airflow in 16302 working face before installment of cooling equipment

Currently, air enthalpy difference method is often used to calculate cooling load of mechanical air conditioning in underground working face. It is stated in Code for design of prevention and elimination of thermal disaster in coal mines (GB50418-2007) that, the actually required cooling load for working face and electromechanical chamber should be greater than or equal to the following calculated value, i.e., $Q \geq M(i_1 - i_2)$ (Guo & Zhu, 2011). i_1 hereby means the enthalpy of inlet airflow on working face before cooling work, and i_2 means the required enthalpy of inlet airflow on working face after cooling. Some scholars believe that the required cooling load for mechanical air conditioning in working face should states as follows: $Q \geq M(i_1 - i_2) + \Sigma Q$ (Ji et al., 2013). i_1 hereby means the enthalpy of airflow at cooling points when airflow reaches its maximum temperatures, and i_2 means the enthalpy of airflow at the target temperature when cooling measures are taken. ΣQ means the sum of heat released from various heat source. Both above formulas have practical applications. Value obtained in the first method is small, while determination of i_2 is not easy, requiring complicated reverse operation of heat and humidity; in the second method, calculation of ΣQ is also quite complicated, and the overall value obtained is large. Furthermore, repeated calculations exist in the second method. To obtain accurate cooling load, based on the summary of the studies of related scholars, this paper concludes that the cooling load should be described as $Q \geq M(i_1 - i_2) + \Delta Q$. The first term hereby means air enthalpy difference at the target temperature of cooling in hottest period in summer at cooling points, and part of the heat released from heat resources is already included in this term; the second term means additional heat release resulted from the implementation of cooling measures. Reason for this is that some of underground heat sources will release more heat because temperature difference increases after cooling measures are taken. So relatively speaking, it's more reasonable.

Situation of heat injuries in 16305 working face is the worst in Jining No. 3 coal mine. Working face is nearly 700 m below ground, situated in No. 16 north mining area. According to observation data, the entering air temperature in the face has reached 31°C in summer, and relative humidity is near 95%; the temperature at air outlet can peak at 33°C with relative humidity approaching 100%; air flow rate is 1000 m³/min and air density is considered to be 1.22 kg/m³. After cooling measures being taken in working face, temperature at C point (Fig. 7) should be controlled at 28°C and relative humidity around 80%. Through calculation, required cooling load for mechanical air conditioning of 16305 working face in Jining No. 3 coal mine is preliminarily determined to be 894 kW. According to provisions in article 5.3.5 in *Code for design of prevention and elimination of thermal disaster in coal mines* (GB50418-2007), the cooling load of refrigeration station should be determined by multiplying required cooling load obtained through calculation by an additional coefficient varying between 1.1 and 1.2. Therefore, refrigerating output of mechanical air conditioning system should be greater than or equal to $894 \times 1.1 \approx 983$ kW. Calculation results for refrigerating output of mechanical air conditioning were summed up in Table 4.

3.3. Design of local air conditioning scheme for working face

According to the calculation results above, to solute the heat injury issue in 16305 working face, refrigerating capacity of the cooling system should be about 1000 kW. Nevertheless, capacity of a single local cooling system and its accessory equipment is generally between 300 kW and 500 kW. That is far lower than 1000 kW. Meanwhile the capacity of centralized cooling system for a whole mine is much higher than 1000 kW. Therefore, the cooling capacity of 1000

TABLE 4

Calculation of refrigerating output for cooling 16305 working face

Project		Jining No. 3 coal mine
Basic data	Cooling positions	16305 working face and the roadway
	Level elevation	-700 m
	Atmosphere pressure	108.7 kPa
	Air flow rate	1000 m ³ /min
	Maximum temperature	33°C
	Relative humidity	100%
	Moisture content	0.03 kg/kg (dry air)
Cooling target	Air enthalpy	110.03 kJ/kg
	Target temperature	28
	Target humidity	80%
	Moisture content	0.0178 kg/kg (dry air)
	Atmosphere pressure	108.7 kPa
Refrigerating output	Air enthalpy	73.6 kJ/kg
	Enthalpy difference	740 kW
	Relative heat sources	154 kW
	Required cooling load	894 kW
	Cooling load of refrigerating station	983 kW
	Cooling capacity of the cooling system	1000 kW

kW is in an embarrassing situation. According to this fact, in light of successful applications of single ZL400 local cooling unit in tunnelling face with cooling capacity of 400 kW, a decision that use single local cooling system to cool working face is made after investigation. Such use will alleviate heat injuries in a certain degree.

Local cooling system was installed in air intake roadway of U-shaped ventilation face in 16305 working face, so as to cool a part of airflow flowing through working face, as shown in Fig. 8. The treatment of airflow in air blending and cooling – the process of fresh air handling at a time in air return system – and the change in *i-d* pattern is described in Fig. 9.

Air parameters in state *A*:

Dry bulb temperature t_A is 31°C; relative humidity φ_A is 95%; atmosphere pressure P is 108.7 kPa. Total air quantity is 1000 m³/min.

Air parameters in state 1:

According to performance of local cooling unit with cooling capacity of 400 kW used in Jining No. 3 coal mine, we can decrease the temperature of airflow at a rate of 500 m³/min from 33°C to 20°C, and raise the relative humidity from 80% to 100%. Thereby dry bulb temperature t_1 in state 1 can be determined as 20.6°C (used in tunnelling face), relative humidity φ_1 as 100%, and atmosphere pressure P as 108.7kPa.

Air parameters in state 2:

Through adiabatic mixing of air parameters in state A and 1 (an approximation to the fact is that no exchange of temperature and humidity has occurred), air parameters in state 2 can be calculated. According to heat and humidity balance, all the relevant parameters in

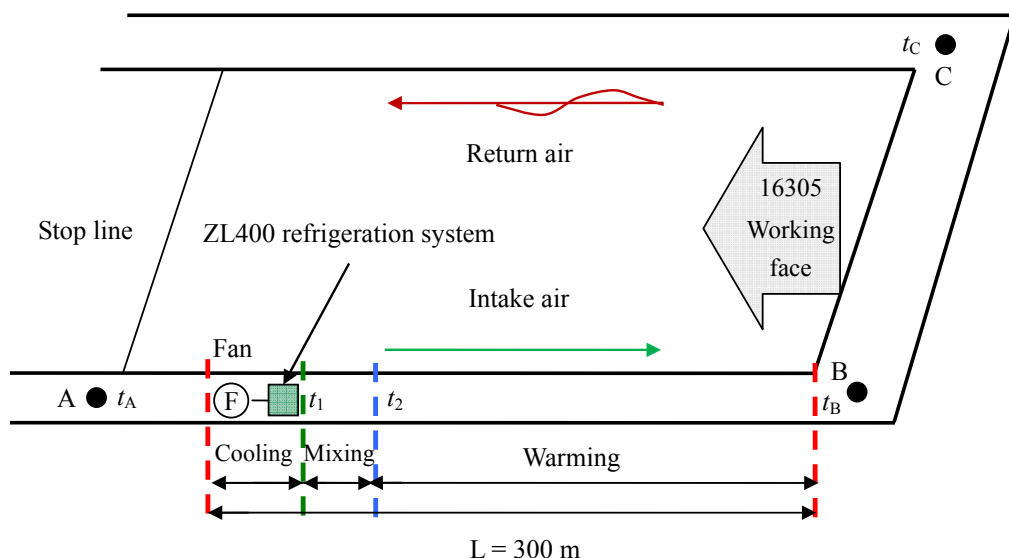

Fig. 8. Thermodynamic change of airflow in intake airway when it takes cooling measures

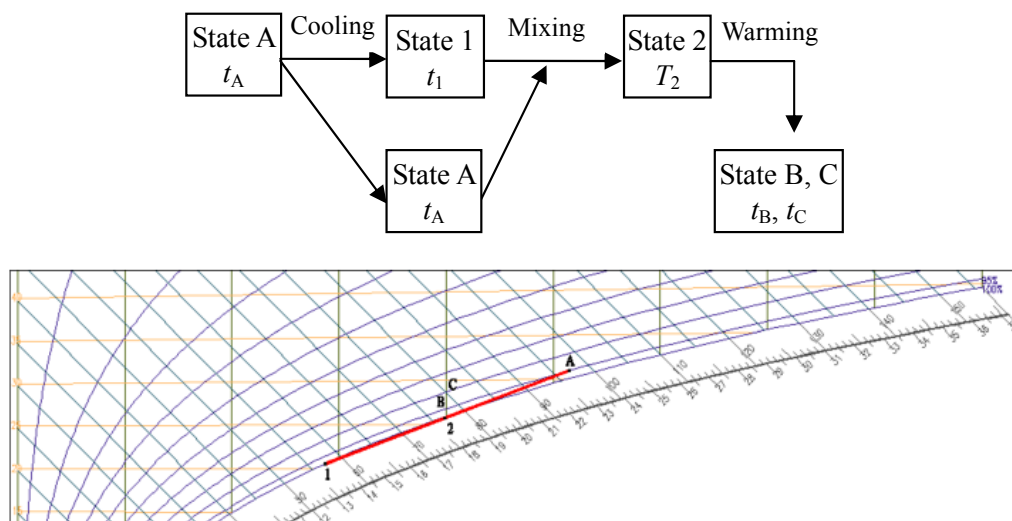

Fig. 9. Process of air handling at a time for air return system in air blending and cooling

state 2 after the mixing are as follows (In the treating process, the mass of dry air is considered as unchanged):

- State A: $t_A = 31^\circ\text{C}$, $\varphi_A = 95\%$, $d_A = 25.747 \text{ g/kg.a}$, $W_A = 500 \text{ m}^3/\text{min}$, $h_A = 97.171 \text{ kJ/kg.a}$;
- State 1: $t_1 = 20.6^\circ\text{C}$, $\varphi_1 = 100\%$, $d_1 = 14.368 \text{ g/kg.a}$, $W_1 = 500 \text{ m}^3/\text{min}$, $h_1 = 57.286 \text{ kJ/kg.a}$;
- State 2: $t_2 = 25.7^\circ\text{C}$, $\varphi_2 = 100\%$, $d_2 = 19.939 \text{ g/kg.a}$, $W_2 = 1000 \text{ m}^3/\text{min}$, $h_2 = 76.815 \text{ kJ/kg.a}$.

When the working face is supplied with sufficient air, and surrounding virgin rock temperature is not high, concentrating cooling air in intake air way within working face is enough to alleviate heat injuries, i.e., position the local cooling unit inside the intake air way. Choice of the position of cooling unit mainly involves consideration of cooling effects and mining speed of the face. Since air has small specific heat capacity and can be heated quickly, the cooling effects become better as the cooling unit is positioned closer to the air inlet of the working face. But if the distance to the face is too short, the cooling unit will be moved frequently, which effects the production. A single set of ZL400 local cooling system is used to cool working face in Jining No. 3 coal mine. The dry bulb temperature of the air after mixing approaches 26°C (Since cooling capacity of the system is insufficient, it's unlikely for temperature at the upper corner of the working face – air outlet – to reach 26°C , as required in the design, thus heat injuries can only be alleviated to a certain degree). Therefore, in order to avoid influences on normal production in working face, while considering cooling effects, the cooling system is positioned 300 m away from air intake at the lower corner of working face, as shown in Fig. 8. Water source (dustproof water) on ground is supplied and used to carry condensation heat of the refrigerating system. Through heat exchange with the condenser in ZL400 cooling unit, the supplied water absorbs heat, and is transferred to water sump in mining area, running through thermal insulation pipeline. Then the water is pumped to ground, as shown in Fig. 10. Field used pictures are shown in Fig. 11.

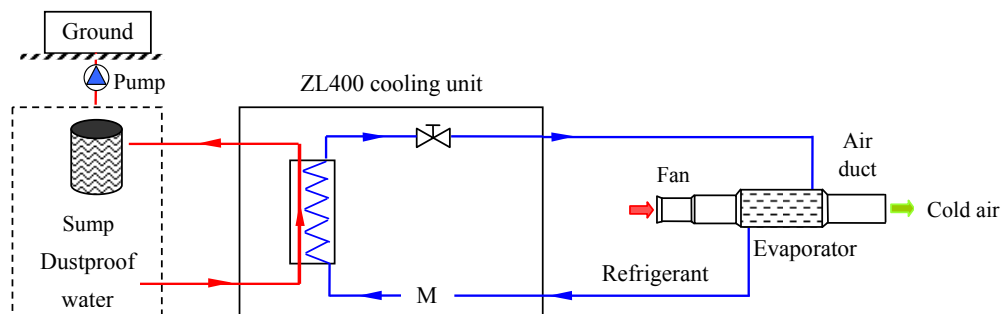

Fig. 10. Supplied water to heat rejection in local cooling system

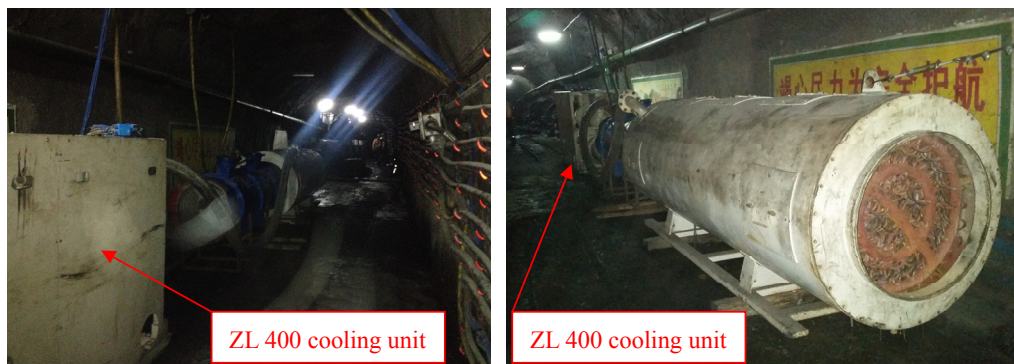

Fig. 11. ZL 400 cooling unit(direct action) used in underground mine

3.4. Test of cooling effects

Local cooling system started to work at the beginning of August 2011 and ended until October 2011. Environmental parameters before and after running of the system are measured, during functioning of the system. Results are shown in Table 5 and Fig. 12.

TABLE 5

Thermal parameters of airflow in working face before and after cooling

Positions		Dry bulb temperature [°C]		Wet bulb temperature [°C]		Relative humidity [%]		Enthalpy [kJ/kg.a]	
		Before cooling	After cooling	Before cooling	After cooling	Before cooling	After cooling	Before cooling	After cooling
1	Air intake on working face	31.8	29.4	30.8	27.7	93.33	87.78	98.978	83.999
2	129 [#] support structure	32.0	29.4	31.2	27.8	94.74	88.46	101.054	84.437
3	100 [#] support structure	32.6	29.5	32.2	28.2	97.62	90.56	106.436	86.227
4	70 [#] support structure	33.2	29.5	33.0	28.2	99.13	90.56	110.953	86.227
5	40 [#] support structure	33.4	29.6	33.0	28.6	97.82	92.68	110.994	88.048
6	10 [#] support structure	33.6	29.8	33.2	29.0	97.87	94.13	112.161	89.919
7	Air outlet on working face	33.6	31.8	33.4	31.8	99.22	100	113.298	103.98

3.5. Results discussion

- (1) From Table 5 and Fig. 12, we can directly see that there was obvious drop in dry and wet bulb temperature after the cooling work, and distinct decreased in relative humidity and enthalpy of airflow in corresponding situations. For specific analysis, the average dry bulb temperature in working face was 32.8°C before the cooling work, while the average dry bulb temperature dropped to 29.8°C after cooling – it decreased by 3.0°C; average wet bulb temperature in working face was 32.4°C before the cooling work, while average wet bulb temperature dropped to 28.8°C after cooling – it decreased by 3.6°C. Similarly, relative humidity dropped by 5% and enthalpy of airflow decreased by 19 kJ/kg.a. Air conditioning effect on working face was obvious. Although local air conditioning system on working face had some air conditioning effects, it can be seen from parameters at key points such as the air intake and outlet for working face, etc. that the system still failed to comply with relevant provisions and even it did not reach the design objectives. Therefore, a single set of ZL400 local cooling system can only alleviate heat injuries to a certain extent, and it cannot solve the issue completely.
- (2) A single set of local cooling system with cooling capacity of 400 kW was used in Jining No. 3 coal mine to cool working face that required cooling capacity of near 1000 kW.

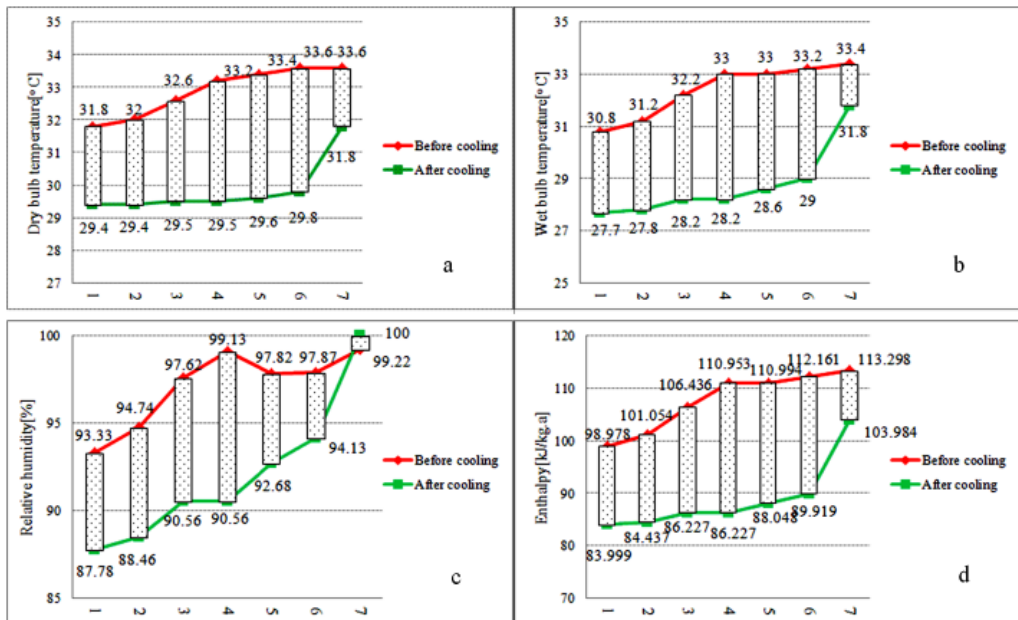

Fig. 12. Comparison and analysis of thermal parameters of airflow before and after cooling

In the preliminary design, the critical conditions at air outlet for the face were taken as the criteria, but because cooling capacity is insufficient, the criteria was replaced by critical conditions at air intake. With the criteria, design and implementation of local cooling scheme was carried out. Nevertheless, result of field test showed that dry bulb temperature of intake airflow was 29.4°C, and relative humidity was 87.78%. It showed that the temperature of cooled airflow increased from 25.7°C to 29.4°C, after traveling a 300-meter distance of roadways to reach the air intake for working face – the range of temperature increase was 3.6°C, and raise of temperature was 0.36°C in every 100 meters. Temperature of airflow raised by 2.4°C over 150-meter distance of working face, and it increased by 1.6°C every 100 meters. Rate of temperature raise in working face was 4 times of that in air intake way. Rate of temperature raise in mining face was 4 times of that in air intake way, which meant that a certain length of air duct had some heat preservation and insulation effects in conveying the cooled air. Due to human activities, operation of electromechanical equipment and mining activities, heat released on the working face was several times of that in air intake roadway.

- (3) After usage of local cooling system in working areas of 16305 working face, dry bulb temperature at air outlet for the face was only 1.8°C lower than that before implementation of cooling measures. Suppose that according to the rule for linear change, if we want to control the dry bulb temperature at air return corner for working face at 28°C, cooling capacity of 1111kW – calculated through $(5/1.8) \times 400 \approx 1111\text{kW}$ – would be required for the temperature difference of 5°C. It would be 11% bigger than the cooling load 1000 kW calculated earlier. This showed that affluence coefficient should be considered in most situations for determination of the cooling capacity of underground

cooling system, due to the complex conditions in underground mines, the approximation and inaccuracy of various parameters used in calculation. Precision and accuracy should be taken into consideration at the time when the relevant basic study is thorough, and the degree of accuracy gradually meets the requirements of projects for allowed engineering errors permissible.

4. Conclusions

Through comprehensive consideration of high temperature, humidity, and dust, together with gas, limited space and frequent change of positions, ZL400 mine cooling unit using semi-hermetic screw compressor was developed. Results of ground tests showed that under design conditions, actual cooling capacity of the cooling unit was 420 kW, with COP reaching 3.4. Taking local cooling measures in 16305 working face in Jining No. 3 coal mine of Shandong Province for example, this paper analyzed the characteristics of airflow in the air-mixing and cooling mode of ZL400 cooling unit used in air intake way for working face. On that basis, the scheme for arrangement and concrete implementation of local cooling system on working face was determined. The system can reduce dry bulb temperature on the working face by 3.0°C on average and 3.8°C at most; it reduced wet bulb temperature by 3.6°C on average and 4.8°C at most; it decreased relative humidity by 5% on average and 8.6% at most; it decreased air enthalpy by 18.7 kJ/kg.a on average and 24.7 kJ/kg.a at most. It had some effects in underground mine air conditioning. The ZL400 cooling unit provided support for solution of issue of local heat injury in mines of China in terms of technology and equipment, and it also enriched the mine cooling technology and equipment system in China.

Acknowledgements

This work has been supported by National Key Technology Research and Development Program of the Ministry of Science and Technology of China (2012BAK04B02), Major Program of Innovation Foundation of China Coal Technology & Engineering Group (2011ZD001), National Natural Science Foundation of China (41672343). The authors thank for these financial supports.

References

- Anderson J.M., 1988. *The future use of refrigeration in British coal mines*. International Journal of Mining and Geological Engineering, 6, p. 41-61.
- ASHRAE, 2007. *Handbook-HVAC Applications (SI), Chapter 27, Mine air conditioning and ventilation*.
- China Bureau of Statistics, 2013. *National economic and social development statistical bulletin in 2013*. 2014-02-24. (in chinese)
- GB 50418-2007. *Code for design of prevention and elimination of thermal disaster in coal mines*. (in chinese).
- Gundersen R. E., Vonglehn F. H., Wilson R.W., 2006. *Improving the efficiency of mine ventilation and cooling system through active control*. Journal of the Mine Ventilation Society of South Africa, 58, p. 130-136.
- Guo Pingye, Zhu Yanyan, 2011. *Back-analysis algorithm of cooling load in deep mines*. Journal of Mining & Safety Engineering, 28, p. 483-487. (in chinese).

- He Manchao, 2009. *Application of HEMS cooling technology in deep mine heat hazard control*. Mining Science and Technology, 19, p. 269-275.
- Howard L. Hartman, Jan M. Mutmansky, Raja V. Ramani, et al., 1997. *Mine ventilation and air conditioning*. New York: John Wiley & Sons, Inc.
- Ji Jianhu, Liao Qiang, Hu Qianting, 2013. *Research and application of cooling load in hot mine*. Journal of Chongqing University, 36, p. 125-130. (in chinese).
- JLL du Plessis, D. Scott, HES. Moorcroft, 2006. *Modern cooling strategies for ultra-deep hydropower mines*. Journal of the Mine Ventilation Society of South Africa, 58, p. 94-99.
- Lowndes I.S., Pickering S.J., Twort C.T., 2004. *The application of exergy analysis to the cooling of a deep UK colliery*. Journal of The South African Institute of Mining and Metallurgy, 57, No 4, p. 381-396.
- McPherson M.J., 1993. *Subsurface ventilation and environmental engineering*. New York: Chapman & Hall.
- Mitchell P., 2003. *Controlling and reducing heat on long-wall faces*. Coal Operators' Conference, University of Wollongong & the Australasian Institute of Mining and Metallurgy, p. 234-245.
- MT/T 1136-2011. *Technical Specifications for Mine Cooling*. (in chinese).
- Nowak B., Kuczera Z., 2012. *Heat power determination of DV-290 refrigerator's evaporator on the basis of thermodynamic parameters of inlet air*. Arch. Min. Sci., 57, No 4, p. 911-920.
- Nowak B., Życzkowski P., 2013. *The effect of temperature glide of R407C refrigerant on the power of evaporator in air refrigerators*. Arch. Min. Sci., 58, No 4, p. 1333-1346.
- Schlote W., 1999. *Control of heat and humidity in German mines*. Proceedings of 8th Mine Ventilation Symposium, Rolla.
- Shayhlislamova I., Alekseenko S., 2011. *The system of the air cooling of deep mines*. Technical and Geoinformational Systems in Mining – Pivnyak, Bondarenko & Kovalevs'ka (eds), London, p. 105-109.
- Vander Walt J., Dekock E.M., Smith L.K., 1983. *The analysis of ventilation and cooling requirements for mines*. Journal of The South African Institute of Mining and Metallurgy, 36, No 1, p. 25-33.
- Wang Lili, Gao Wenjing, 2013. *1000 m depth mine perspective in China*. 2013-08-1(003), p. 1-6. (in chinese).
- Wilson R. W., Pieters A., 2008. *Design and construction of a surface air cooling and refrigeration installation at a South African mine*. 12th U.S./North American Mine Ventilation Symposium 2008 – Wallace (ed), Reno, p. 191-195.
- Wojciechowski J., 2013. *Application of the GMC-1000 and GMC-2000 mine cooling units for central air-conditioning in underground mines*. Arch. Min. Sci., 58, No 1, p. 199-216.
- Yang Xiaojie, Han Qiaoyun, Pang Jiewen, 2011. *Progress of heat-hazard treatment in deep mines*. Mining Science and Technology, 21, p. 295-299.