

THE FLUIDITY OF Al-Si ALLOY: COMPUTER SIMULATION OF THE INFLUENCE OF TEMPERATURE, COMPOSITION, AND POURING SPEED

The purpose of this study is to identify relationships between the values of the fluidity obtained by computer simulation and by an experimental test in the horizontal three-channel mould designed in accordance with the Measurement Systems Analysis. Al-Si alloy was a model material. The factors affecting the fluidity varied in following ranges: Si content 5 wt.% – 12 wt.%, Fe content 0.15 wt.% – 0.3wt. %, the pouring temperature 605°C-830°C, and the pouring speed $100 \text{ g} \cdot \text{s}^{-1}$ – $400 \text{ g} \cdot \text{s}^{-1}$. The software NovaFlow&Solid was used for simulations. The statistically significant difference between the value of fluidity calculated by the equation and obtained by experiment was not found. This design simplifies the calculation of the capability of the measurement process of the fluidity with full replacement of experiments by calculation, using regression equation.

Keywords: Al-Si; fluidity; computer simulation; regression analysis; Monte Carlo method

1. Introduction

The fluidity is the ability of a molten metal to fill the mould cavity. Al – Si alloys with Si content ranging from 7 to 18 wt.% have excellent fluidity. Iron has a contradictory role in aluminium alloys. Wang [1] highlighted the effect of iron on the soldering – a sticking between the iron parts of the mould and aluminium matrix of the casting. Iron hinders the sticking, increases strength, hardness, fluidity and mechanical properties at high temperatures in the range between 0.3 wt.% and 0.5 wt.%. If its content is over 0.5 wt.% brittle and hard Al-Fe-Si phases occur. Long needles of FeSiAl_5 (β phase), penetrating aluminium matrix and eutectic cells are extra-hazardous. They cause the premature failure of the castings by notch effect.

Di Sabatino et al. [2], on the other hand, reported that the Fe content does not exert any effect on fluidity up to a maximum level of 0.233 wt.%. Mbuya [3] underlined how the iron-bearing phases formed in the alloys obstruct the inter-dendritic flow channels during the last stage of solidification, revealed a deleterious effect of iron on the fluidity. Petrik [4] tested the fluidity of Al-9.75 Si alloy by vertical test: the fluidity increased up to 1 wt.% of Fe, then began to decline. Bolibruchová at al. [5] recommend easily accessible manganese as iron corrector. It was found, that needles of Al_5FeSi are much more trend to cracks like particles of Chinese script phase $\text{Al}_{15}(\text{FeMn})_3\text{Si}_2$.

Djordjević [6] ranks alloy variables (chemical composition and solidification range), mould/alloy variables (coating and thermal conductivity) and test variables (superheat and oxide

content) among the factors affecting the fluidity. Adefuye [7] reports decreasing of the fluidity with increasing turbulence in the gating system as regards the pouring speed. Timelli and Bonollo [8] highlight a responsibility of the pouring temperature for the most pronounced change in fluidity of the melt.

In practice, the most common fluidity test methods are the horizontal and vertical tests. The result of the horizontal test is the rod or the spiral, their length is a measure of the fluidity. Adefuye [7] describes the fluidity test in multi – channel mould with fixed width and scalable depth of channels. However, in the channel with the depth less than 5 mm, which also includes the proposed mould, the measured value of the fluidity is affected by the surface tension. Campbell and Harding [9] have come to the conclusion that the determination of fluidity as a function of the thickness of the cross-section is a valuable method of determining the effective surface tension in filling problems.

Trial and error method of determining the fluidity by experimental work is time-consuming as well as expensive approach. Therefore, it seems advantageous to replace the experiment by computer simulation as a first approximation. Futáš [10,11] evaluated the relationship between the simulated and experimental vertical fluidity tests without statistically significant difference in results. The correlation between the simulation results by software MAGMA and experimental results of the spiral test presented Di Sabatino [2]. The American Foundrymen Society in a survey in 1999 found that more than 1200 foundries, worldwide, are using numerical simulation for studying and optimizing their processes. Ravi [12] published the

* TECHNICAL UNIVERSITY OF KOSICE, FACULTY OF MATERIALS, METALLURGY AND RECYCLING, LETNÁ 9, 042 00 KOSICE, SLOVAK REPUBLIC

Corresponding author: jozef.petrík@tuke.sk

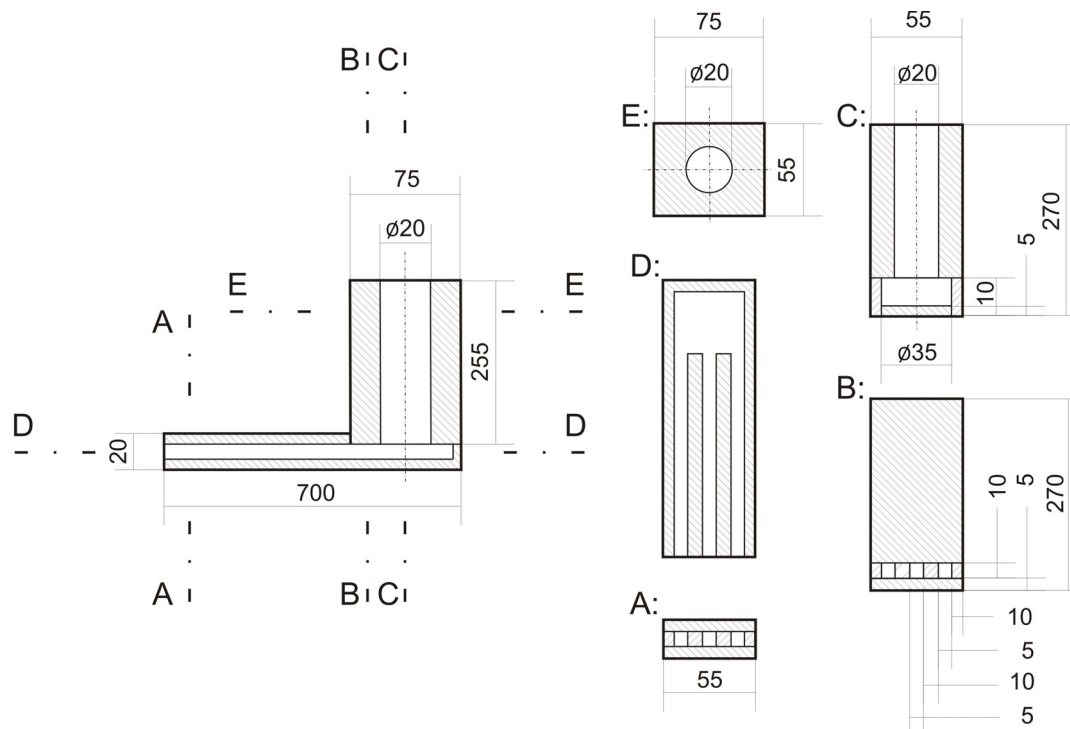

Fig. 1. The layout of the horizontal mould

survey of 215 foundries all over India, which revealed the use of CAD/CAM and simulation reduced the average lead time for first good sample casting by 30%: from 10 weeks to 7 weeks and halved the average rejection rate.

According to the standard ISO/TR 10017:2003 [13] the simulation is defined as a collective term for procedures, by which a system is represented mathematically using a computer program for the solution of a problem. In the context of theoretical science, simulation is used if no comprehensive theory for the solution of a problem is known, and when the solution can be obtained through brute computer force. Within theoretical sciences, simulation (in particular the Monte-Carlo method) is used if explicit calculations of solutions to problems are impossible or too cumbersome to carry out directly.

The aim of this study is to identify relationships between the values of the fluidity obtained by computer simulation and by experimental test in the horizontal three-channel mould designed in accordance with the methodology of the MSA (Measurement systems Analysis) [14]. This design of the mould is suitable for the evaluation of the capability of the fluidity measuring process. It allows, to a large extent, the testing in the conditions of the repeatability. The MSA method is recommended in the reference manuals, used in the automotive industry and helps to conform to IATF ISO/TS 16 949:2016 requirements.

The aim of the study was achieved by successive solving of the following tasks:

1. A comparison of results obtained by simulation and experiment for selected levels of factors (content of silicon and iron, pouring temperature and pouring speed).
2. If the match between the results of simulation and experiment was sufficient, additional simulations were performed.

The levels of these simulation factors were chosen to interpolate the results obtained in point 1.

3. The equation describing the influence of considered factors on the fluidity was calculated by the regression analysis.
4. The values of the fluidity calculated by the equation were compared with results of practical tests.
5. The probability of successful pouring with desired fluidity were verified by Monte Carlo simulation.

2. Experimental

The 3D model of the mould with horizontal channels was created on CAD system CATIA V5 R19. The computer simulation was realized by the software NovaFlow& Solid CV with the same conditions used in a practical experiment. More information about the software can be found at [15].

The Al-Si alloy with 5÷12 wt.% of Si and 0.3 wt.% of Mn as the iron corrector was the model material. The Fe content ranged between 0.15 wt.% and 0.3 wt.%. The charge was melted in the fire-clay/graphite crucible in an electric resistance furnace. The casting temperatures ranged between 605°C and 830°C and the pouring speed between 100 g·s⁻¹ and 400 g·s⁻¹. The pouring speed was determined additionally from the casting weight and casting time.

The melt was poured into the mould whose core was horizontal three-channels system, made from carbon steel STN 41 1375 (comparable with EN S235 JRG 2), see in Fig. 1, The mould was screwed to the massive metallic block to prevent its distortion. The channels have the length 700 mm, the depth 10 mm, the width 5 mm and open ends. The runner was a steel

block with the height 280 mm and the diameter of the downsprue 20 mm. The mould was heated up $120^{\circ}\text{C}\pm 10^{\circ}\text{C}$. The measure of the fluidity was the mean flow length (L , in mm) of all three channels of the mould.

The cooling rate of the castings was about $20^{\circ}\text{C}\cdot\text{s}^{-1}$ in the range between 500°C and 200°C . Samples for metallographic analysis were taken from mid-length of castings. Polished metallographic samples were etched with 25% water solution of H_2SO_4 at 75°C and subsequently with 0.5% water solution of HF. The morphology of eutectic Si (β phase) and its inter-particle spacing λ_{β} were evaluated by optical microscope NEOPHOT 32 and software ImageJ. The analyser LINK ISIS was used for determining intermetallic phase by EDX method.

The Monte Carlo method was used for the evaluation of the stability of used model, i. e. how will the value of the fluidity, calculated by equation (1) change, if the input data will be given in the form of interval and the experiment would be repeated several times. Sienkowski [16] describes the Monte Carlo method or probability simulation as a technique used to understand the impact of risk and uncertainty in forecasting models. The key feature of a Monte Carlo simulation is that it can tell you – based on how you create the ranges of estimates – how likely the resulting outcomes are. Monte Carlo simulation repeats the calculation thousands of times using different randomly selected values in each calculation.

3. Results

Eutectic silicon is segregated in the form of lamellar (the length about $10\ \mu\text{m}$) and globular particles (diameter about $4\ \mu\text{m}$) with inter-particle spacing λ_{β} $2.5\ \mu\text{m}$. It is partially modified as a result of the high cooling rate. Grey – rusty skeleton – shaped particles “Chinese script” $(\text{FeMn})_3\text{Si}_2\text{Al}_{15}$ with maximal dimension $80\ \mu\text{m}$ rarely occur in eutectic cells. The presence of long needles of FeSiAl_5 was not observed.

The fluidity of Al-Si10 alloy was tested in the range of the pouring temperatures between 605°C and 830°C . Practical experiments were carried out by three founders: “veterans” A, B and the “beginner” C. Both temperature ($p = 1.51\cdot 10^{-5}$) and founders A, B and C ($p = 22.9\cdot 10^{-5}$) have statistically significant effect on the value of fluidity according to the two-factor ANOVA (Analysis of Variance) without replication. p – value is the probability level for an ANOVA study, given the ANOVA study’s between and within groups degrees of freedom and associated F-value. If p – value is greater than the chosen significance level ($\alpha = 0.05$), the analysed factor does not have a statistically significant effect. If the “beginner’s” results were not taken into account, the impact of the operators on fluidity was not statistically significant ($p = 0.614002$).

In addition, the statistical significance of differences between fluidities measured at individual casting temperature levels by operators (A, B, C) and those obtained by computer simulation (D) was evaluated by paired t-test at significance level $\alpha = 0.05$. The resulting p – values are in Table 1.

The difference between simulation (D) and founder A or B as well as between founders A and B is not statistically significant. However, the difference between the “beginner” C and the simulation D is extremely significant.

TABLE 1

The results of paired t-test and correlation analysis

		A	B	C	D
paired t-test (p)	A	—	0.6743	—	0.2530
	B	0.6743	—	—	0.6286
	C	—	—	—	0.0001
	D	0.2530	0.6286	0.0001	—
correlation (r^2)	A				
	D	0.9025	0.8196	0.8615	—

As can be seen in Fig. 2 and Table 1, the correlation between the results of the simulation D and experimentally obtained results is strong.

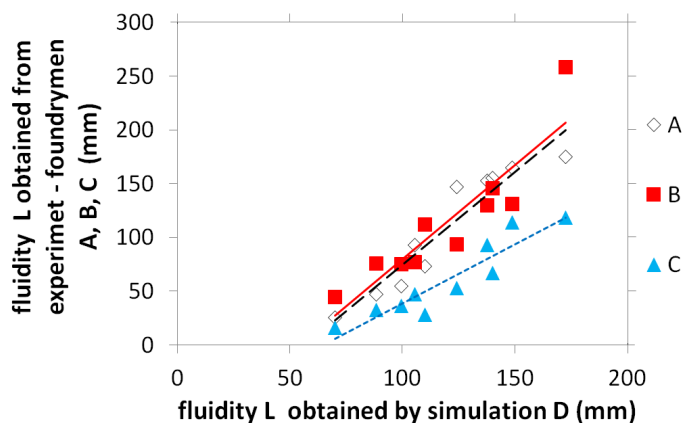

Fig. 2. The relation between fluidity estimated by computer simulation D and from experiments carried out by founders A, B and C using the horizontal mould

The consistency between the results of casting experiments and computer simulation enables anyone to create a model for regression analysis using the computer simulation. The model includes 50 combinations of input parameters to the extent of foresaid levels of the silicon content (ranged between 5 wt.% and 12 wt.%), iron content (ranged between 0.15 wt.% and 0.3 wt.%), casting temperatures (ranged between 650°C and 850°C), and casting speeds (ranged between $100\ \text{g}\cdot\text{s}^{-1}$ and $400\ \text{g}\cdot\text{s}^{-1}$). The observed fluidity ranged between 30.5 mm and 260.3 mm. The pouring speed was chosen based on the actual results of ten founders ($100\text{--}400\ \text{g}\cdot\text{s}^{-1}$). The Eq. (1) describing the relationship between inputs and the fluidity was calculated by multiple regression using program EXCEL-LINEST.

$$L = (0.43917*T) + (13.41338*\%Si) + (0.55806*PS) - (11.9218*\%Fe) \quad (1)$$

Where:

– L is the fluidity (mm),

- T is the pouring temperature [°C],
- %Si is the content of Si [wt.%],
- %Fe is the content of Fe [wt.%],
- PS is the pouring speed [$\text{g} \cdot \text{s}^{-1}$].

The value of the determination coefficient $r^2 = 0.86848$ indicates a strong relationship between considered input parameters and fluidity, 86.85% of the variation of the fluidity can be explained by the effect of these parameters. Used calculations and interpretation of results are in accordance with the procedure referred in [17].

An analysis of the regression Eq. (1) obtained using the QUANTUM XL software by module design of experiment/design sheet and by Pareto analysis revealed a practically equivalent statistically significant influence of the pouring temperature, the content of Si and the pouring speed on fluidity ($p = 0.0$ for all factors). The influence of Fe is not statistically significant ($p = 0.850$). The results of Pareto analysis show that the studied factors influence the fluidity in following order: pouring speed, content of Si, pouring temperature and content of Fe.

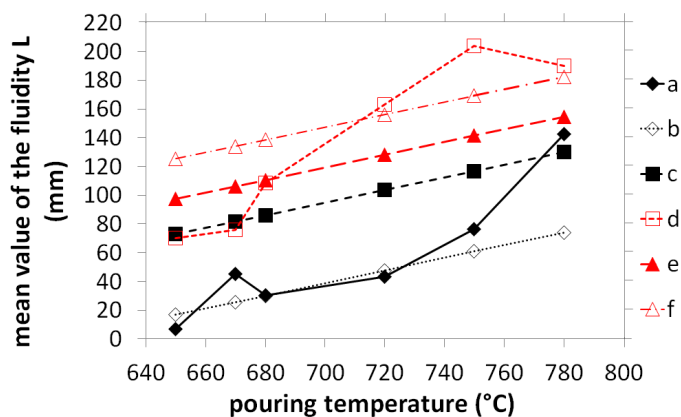

Fig. 3. The relationship between casting temperature and the value of the fluidity obtained from the experiment (a – 5% Si; d – 11% Si) and values obtained from regression equation – for the pouring speeds PS = $200 \text{ g} \cdot \text{s}^{-1}$ (b – 5% Si; e – 11% Si) and PS = $250 \text{ g} \cdot \text{s}^{-1}$ (c – 5% Si; f – 11% Si)

The values of the fluidity calculated using Eq. (1) (b,c,e,f – and obtained from experiment – a,d – were compared. The Al-Si alloy with 5 wt.% (a, b, c) or 11 wt.% Si (d, e, f), 0.15 wt.% Fe and 0.3 wt.% Mn was poured at temperatures between 650°C and 780°C . The pouring speed was PS = $200 \text{ g} \cdot \text{s}^{-1}$ (b,e) and PS = $250 \text{ g} \cdot \text{s}^{-1}$ (a,c,d,f). The relationship between the pouring temperature and fluidity is in Fig. 3 and that between experimentally obtained fluidity and calculated fluidity in Fig. 4. The correlation can be considered strong: the value of Pearson's coefficient $r^2 = 0.8362$ for the relationship between a and b; $r^2 = 0.8361$ for the relationship between a and c; $r^2 = 0.9043$ for the relationship between d and e and $r^2 = 0.9035$ for the relationship between d and f.

According to paired t-test, the differences between experimental results of the founder (A) and those calculated by (1) are not statistically significant (p value = 0.2605 for B and 0.3167 for C) for the alloy with 5 wt.% of silicon. The differences between

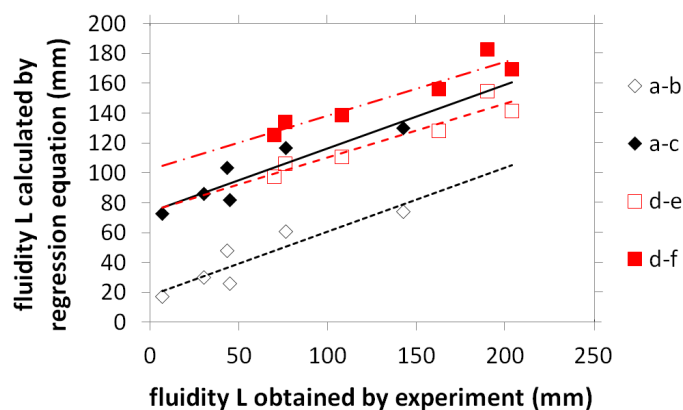

Fig. 4. Linear relationship between the values of fluidity obtained from the experiment (a – 5% Si; d – 9.75% Si) and from the regression equation – for the pouring speeds PS = $200 \text{ g} \cdot \text{s}^{-1}$ (b – 5% Si; e – 11% Si) and PS = $250 \text{ g} \cdot \text{s}^{-1}$ (c – 5% Si; f – 11% Si)

the results of the founder D and those calculated by (1) also are not statistically significant ($p = 0.4652$ for E and $p = 0.3263$ for F) for the alloy with 11 wt.% of silicon.

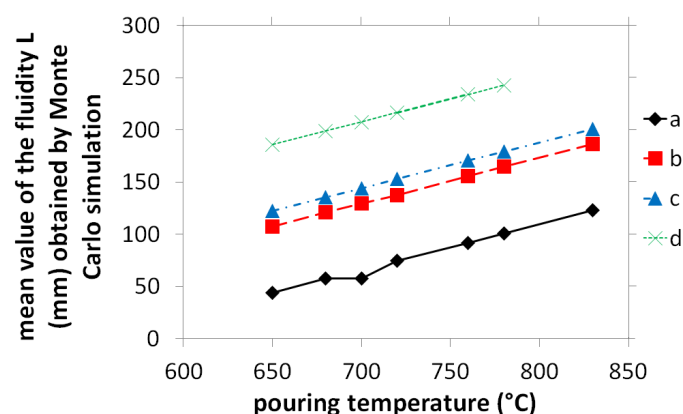

Fig. 5. The relationship between the pouring temperature and fluidity for compositions: a (5.0% Si, PS = $250 \text{ g} \cdot \text{s}^{-1}$), b (9.75% Si, PS = $250 \text{ g} \cdot \text{s}^{-1}$), c (5.0% Si, PS = $390 \text{ g} \cdot \text{s}^{-1}$) and d (9.75% Si, PS = $390 \text{ g} \cdot \text{s}^{-1}$), obtained by Monte Carlo simulation

The range of input data for Monte Carlo Simulation, done by Software Quantum XL is in Table 2. A triangular distribution was considered. The levels of pouring temperature were 650, 680, 700, 720, 760, 780 and 800°C ranged $\pm 10^\circ\text{C}$ (i.e. 640°C – 660°C etc.). The output of the simulation are the quantities of the fluidity – mean, standard deviation, one side capability index $C_{pk(LSL)}$ and the proportion of values outside of tolerance limit (lower standard limit $LSL = 200 \text{ mm}$).

$$C_{pk(LSL)} = \frac{\bar{x} - LSL}{3\sigma} \quad (2)$$

\bar{x} is the mean of the process,

σ is the standard deviation of the process.

The graphical outputs for 10,000 simulations are in Fig. 5 (mean value), Fig. 6 (C_{pk}) and Fig. 7 (proportion of values outside the tolerance limit) for the alloys with 5 wt.% and 9.75 wt.% of silicon and pouring speeds 250 and $400 \text{ g} \cdot \text{s}^{-1}$.

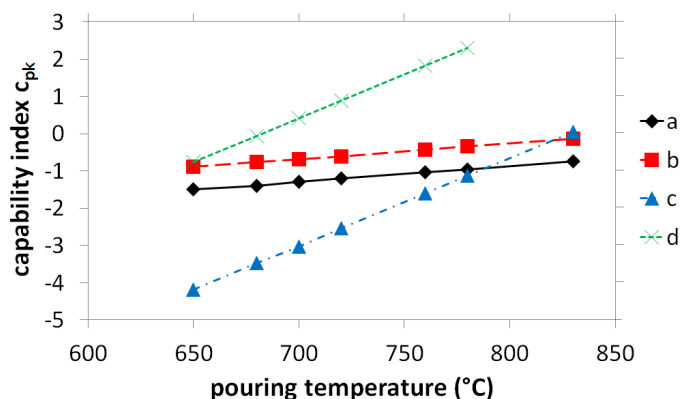

Fig. 6. The relationship between the pouring temperature and capability index C_{pk} for compositions: a (5.0% Si, PS = 250 $\text{g} \cdot \text{s}^{-1}$), b (9.75% Si, PS = 250 $\text{g} \cdot \text{s}^{-1}$), c (5.0% Si, PS = 390 $\text{g} \cdot \text{s}^{-1}$) and d (9.75% Si, PS = 390 $\text{g} \cdot \text{s}^{-1}$), obtained by Monte Carlo simulation

TABLE 2

Input data for Monte Carlo simulation

	Range	a	b	c	d
%Si	$\pm 1\%$	5.0	9.75	5.0	9.75
%Fe	0.15-0.30	0.25	0.25	0.25	0.25
Pouring speed PS [$\text{g} \cdot \text{s}^{-1}$]	100-400	250	250	—	—
	380-400	—	—	390	390

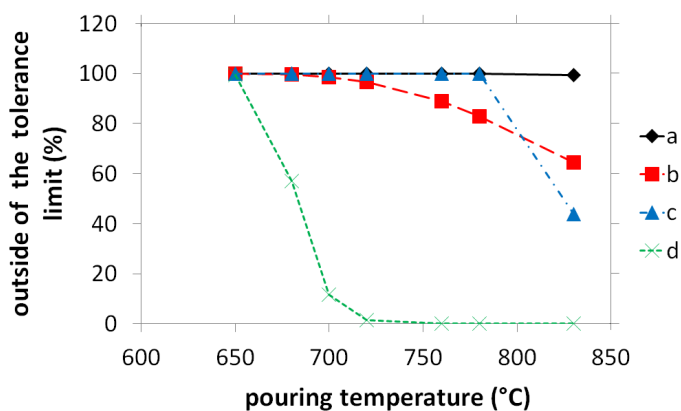

Fig. 7. The relationship between the pouring temperature and the proportion of the values of fluidity, outside of tolerance limit for compositions: a (5.0% Si, PS = 250 $\text{g} \cdot \text{s}^{-1}$), b (9.75% Si, PS = 250 $\text{g} \cdot \text{s}^{-1}$), c (5.0% Si, PS = 390 $\text{g} \cdot \text{s}^{-1}$) and d (9.75% Si, PS = 390 $\text{g} \cdot \text{s}^{-1}$), obtained by Monte Carlo simulation

For example, if the proposed pouring temperature is 720°C, the real temperature could be in the range 710°C-730°C (effect of the uncertainty of the measuring instrument). Repeated analyses have confirmed some variability in chemical composition of the melt (e.i. different values of e.g. silicon content at the beginning and at the end of melting, but also values of silicon content from repeated analyses of the sample). When we are taking into account the uncertainty of analytical methods, the actual content of silicon could be 9.75 wt.% \pm 1.0 wt. % and that of iron 0.25 wt.% $< +0.05; -0.10 \text{ wt.}\% >$. The intended value of the pouring speed was 250 $\text{g} \cdot \text{s}^{-1}$. However, it is very variable depending on

the founder. It has been found that it varies between 100 $\text{g} \cdot \text{s}^{-1}$ and 400 $\text{g} \cdot \text{s}^{-1}$. Only 350 out of 10,000 casts have achieved the fluidity of 200 mm when the process was simulated by Monte Carlo with input data from above mentioned ranges. The distribution of the results is in Fig. 8.

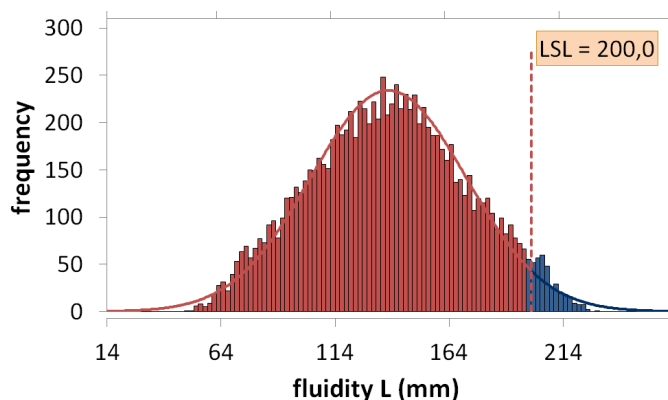

Fig. 8. The example of the distribution of the results obtained by Monte Carlo simulation

4. Conclusions

1. The three-channel horizontal mould approximates the conditions of the fluidity test to the requirements of repeatability (i.e. the melt flows in the three channels under practically the same conditions at the same time). It is used to simplify and clarify the evaluation of the capability of the fluidity test.
2. The fluidity for fifty combinations of input variables – the content of silicon, iron, the casting temperature and the pouring speed was subsequently determined by the computer simulation. The results of simulation were processed by multiple regression analysis. The obtained equation describes the relationship between input variables and the fluidity.
3. As it results from the regression equation in the analysed range with the increase in silicon content, the pouring temperature and the pouring speed, the fluidity increases. On the contrary, with the increase in iron content, the fluidity decreases.
4. The experimentally obtained the values of fluidity and the values of fluidity calculated by the equation have been compared and the differences were not statistically significant.
5. The published equation may be useful in a small foundry with manual pouring of small series of castings with variable composition for preliminary calculation of the fluidity.

Acknowledgments

This work was supported by the Slovak Grant Agency for Science VEGA 1/0073/17 and 1/0703/16.

REFERENCES

- [1] L. Wang, M. Makhlof, D. Apelian, *Int. Mater. Rev.* **40** (6), 221-238 (2010). <https://doi.org/10.1179/imr.1995.40.6.221>.
- [2] M. Di Sabatino, L. Arnborg, F. Bonollo, *Metall. Sci. Technol.* **23**, 3-10 (2005).
- [3] T.O. Mbuya, B.O. Odera, S.P. Ng'ang'a, *Int. J. Cast Met. Res.* **16** (5), 451-465 (2003).
- [4] J. Petrik, P. Szarvasy, V. Špet'uch, *Acta Metall. Slovaca* **10** (2), 73-79 (2004). http://www.ams.tuke.sk/data/ams_online/2004/number2/mag01/mag01.pdf
- [5] D. Bolibruchová, M. Žihalová, *Arch. Metall. Mater.* **59** (3), 1029-1032 (2014). DOI: 10.2478/amm-2014-0172.
- [6] M.B. Djurdjević, Z. Odanović, J. Pavlović-Krstić, *Assoc. Metall. Eng. Serbia.* **16** (1), 63-76 (2010). <https://www.dykast.com/user/products/4329-pdfs-2-file.pdf>
- [7] O.A. Adefuye, *Transnatl. J. Sci. Technol.* **4** (1), 16-30 (2014). http://tjournal.org/tjst_january_2014/03.pdf?i=1
- [8] G. Timelli, F. Bonollo, *Int. J. Cast Met. Res.* **20** (6), 304-311 (2007). doi:10.1179/136404608X286110
- [9] J. Campbell, R.A. Harding, *Train. Alum. Appl. Technol. Talat Lect.* 3205, 2-4 (1994).
- [10] P. Futáš, J. Petrik, A. Pribulová, The analysis of Al-Si alloys fluidity test in computer simulation, in: *Proceedings of the 14th SGEM GeoConference on Informatics, Geoinformatics and Remote Sensing*, Albena, Bulgaria, 371-378 (2014). doi:10.5593/SGEM2014/B21/S7.047
- [11] P. Futáš, J. Petrik, A. Pribulová, M. Bartošová, *Key Eng. Mater.* **635**, 45-50 (2014). doi:10.4028/www.scientific.net/KEM.635.45
- [12] B. Ravi, *Indian Foundry J. (special issue)*, 1-12 (2008). http://orthocad.iitb.ac.in/Academy/TechnicalPapers/2008/2008IFJ_CastingSimulation.pdf
- [13] ISO/TR 10017:2003 *Guidance on statistical techniques for ISO 9001:2000*, ISO, Brussels (2003).
- [14] M. Down et al. *Measurement Systems Analysis. AIAG Reference Manual*, Chrysler Group LLC, Ford Motor Company, and General Motors Corporation, Southfield, 103-123 (2010).
- [15] <http://www.novacast.se/product/novaflowsolid>, accessed: 30.10.2016
- [16] Sienkowski, *Metrol. Meas. Syst.* **20** (2), 249-262 (2013). doi:10.2478/mms-2013-0022
- [17] <http://www.biostathandbook.com/multipleregression.html>, accessed 05.03.2016