

DOI: 10.24425/amm.2019.126231

Z. ZAWIEJA*, J. SAWICKI*#

THERMOGRAVIMETRIC ANALYSIS OF MODIFIED CELLULOSE MIXTURES IN AIR

The paper includes the TG-DTG thermogravimetric air-testing of a cellulose mixture modified with the additives of expanded vermiculite or expanded perlite. A thermal degradation test was carried out at 1000°C with a simultaneous qualitative analysis of the emitted gases. During the thermal degradation process, the thermal effects were also measured. The research results indicate that expanded vermiculite or expanded perlite do not emit toxic gases during thermal degradation. The cellulose mixture modification, with the additives of expanded vermiculite or perlite, does not result in the creation of new gaseous compounds in the process of thermal degradation. As investigated below, the mixtures tested in this article find application in gating systems for supplying liquid metal in no-bake moulds. Such cellulose-based material solutions shall allow the foundry industry to introduce less gas vaporising technologies within the entire casting production process.

Keywords: expanded vermiculite, expanded perlite, modified cellulose mixture, TG-DTG analysis

1. Introduction

Due to their very unique properties, expanded vermiculite and expanded perlite constitute materials tested by many scientists in terms of their use in various industries. They have a very high thermal resistance with a low bulk density [1-3]. At the same time, they constitute hygroscopic materials for different liquid or resin materials [4-6] simultaneously with the environmental properties for which they are used e.g. in the agricultural industry [7].

Expanded vermiculite and expanded perlite were mainly used in construction applications related to thermal insulation applications. At the same time, reducing the finished product weight [8-14], although, the properties of high thermal resistance can also be used in metal industry which focuses on foundry technologies.

The paper report the results of the TG-DTG thermogravimetric air-testing at 1000°C of expanded vermiculite, expanded perlite and a mixture of these materials with paper pulp as a source of cellulose. Inorganic aluminosilicate resin was applied as binders for the mixtures. As mentioned above, the entire idea of having different material compositions based on cellulose mixtures modified by inorganic ingredients is aimed at liquid iron metal contact applications. The investigated mixtures might be considered as alternative solutions to making gating systems which allow liquid metal flow into no-bake moulds in a short time. Other published papers have focused on similar mixtures [15-18] have also shown great potential future applications for gating systems and for no-bake moulds in the foundry industry.

The investigation is supposed to give a better overview of modified cellulose based on mixture behaviours taking into account a high-temperature working environment.

2. Research materials and methodology

The samples of the FINE grade type expanded vermiculite, with a bulk density of 80÷100 kg/m³, and the EP150 grade expanded perlite, with a bulk density of 40÷80 kg/m³, were used for testing. Both products came from a Polish production plant company – the PERLIPOL General Partnership [19].

In Table 1 and Table 2, the typical chemical compositions of expanded vermiculite and perlite were included based on supplier analyses.

TABLE 1
Chemical composition of expanded vermiculite [19]

Chemical composition	SiO ₂	Al ₂ O ₃	Fe ₂ O ₃	K ₂ O	P ₂ O ₅	TiO ₂
Weight volume [%]	35-41	6-11	6-9	3-6	0,2-2	0,6-1,4

TABLE 2
Chemical composition of expanded perlite [19]

Chemical composition	SiO ₂	Al ₂ O ₃	Fe ₂ O ₃	K ₂ O	Na ₂ O	CaO	MgO
Weight volume [%]	70-75	12-15	0,5-2	3-5	3-4	0,5-1,5	0,2-0,7

* LODZ UNIVERSITY OF TECHNOLOGY, INSTITUTE OF MATERIALS SCIENCE AND ENGINEERING, 1/15 STEFANOWSKIEGO STR., 90-924 LODZ, POLAND

Corresponding author: jacek.sawicki@p.lodz.pl

Selected and cleaned scrap paper (Ekofiber®) produced by Nordiska Ekofiber Polska Ltd. was used as a source of paper pulp for the modified mixture samples. The binder for the implementation of the modified paper pulp with the additive of expanded vermiculite or expanded perlite included aluminosilicate resin is available from Geopol. The compositions of the modified mixtures of paper pulp are given in Table 3.

TABLE 3

Chemical composition of paper pulp modified samples

	Paper pulp	Expanded Vermiculite	Expanded Perlite	Aluminio-silicate binder
Sample 1	270 g	30 g	—	150 g
Sample 2	270 g	—	30 g	150 g

The research material was placed in the TG-DTG camera *Setsys TG-DTG 16* by the Setaram (France). Measurements were carried out in dynamic airflow conditions. The station scheme is presented in Fig. 1.

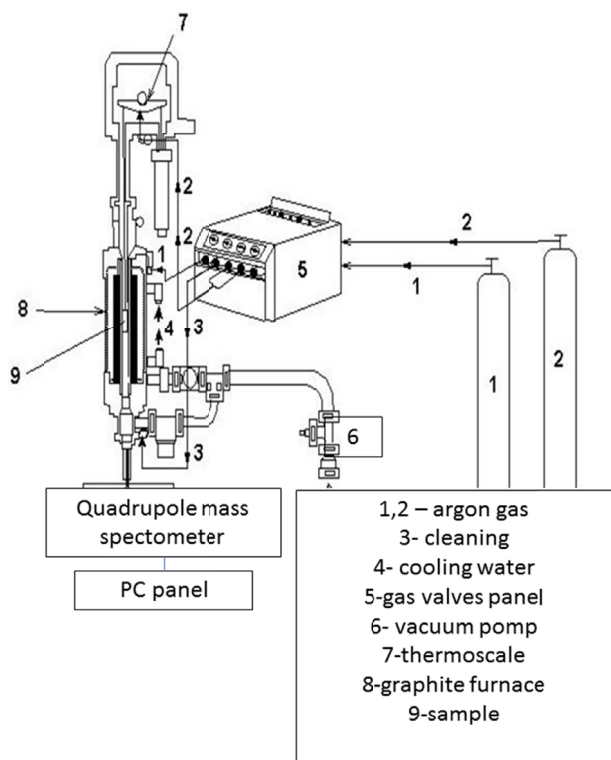

Fig. 1. TG-DTG measurement station scheme

The airflow volume rate was 40 cm³/min. The tested sample (9 in Fig. 1) was placed in platinum crucibles coupled with a thermobalance beam (7 in Fig. 1). A weight sample – typically below 10 mg – was placed on a crucible in a graphite furnace (8 in Fig. 1) and heated at a linear speed of 10°C per minute. The measurements were conducted from an ambient temperature to a maximum of 1000°C. The graphite internal parts of the furnace are protected against oxidation by argon as a protective gas (2 in Fig. 1), which washes the furnace during its operation. The furnace shape is cylindrical and is cooled by water circulation.

The control and regulation take place in a panel of regulation of flows (5 in Fig. 1). The carrier gas is at a normal pressure when thermoanalytical measurements are being taken. The gas cleaning is to remove fumes emitted by the sample from the furnace chamber. The inert gas (argon) may protect the sample from oxidation during heating. The device for the TG-DTG analysis is programmed and controlled by computer, which is also used for storing the test results as well as for processing and interpreting them.

At the same time, along with the TG-DGT testing thermal degradation process, a qualitative analysis of the *ThermoStar* quadrupole mass spectrometer – belonging to Balzers of Germany – was carried out. The spectrometer was calibrated for measuring the molecules with a molar weight from 2 to 78 g/mol.

3. Results and discussion

The measurements were carried out in air hence the mass spectrometer in the entire temperature range showed the emission of H₂, H₂O, O₂, N₂ at a constant level of 10⁻⁸–10⁻⁹ [A]. In view of the above, the measurement results of these compounds were omitted.

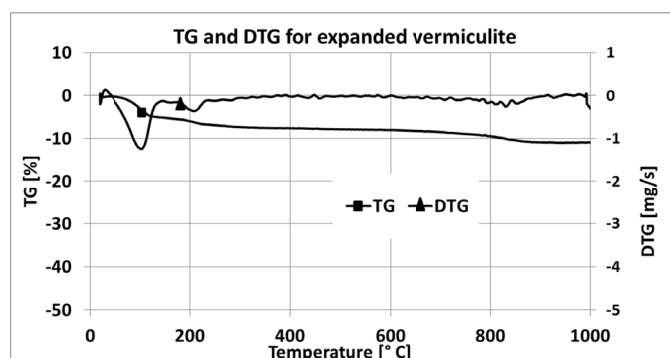

Fig. 2. TG-DTG measurement of expanded vermiculite

The measurement results of the thermogravimetric analysis of expanded vermiculite are presented in Fig. 2. The TG and DTG curves show that an increase in temperature, in the first stage in the range of 60–135°C, results in a loss of weight by 5.1%. This is related to the loss of water from expanded vermiculite reflecting hygroscopicity characteristics [4–6]. The next water loss effect is associated with the dehydration process that occurs in the range of high temperatures from 190–230°C and can also be observed in other studies of similar clay materials [20]. In the range up to 230°C, there is also the main weight loss related to the loss of water to a level of 6.8%. Other weight loss should be associated with dehydroxylation and the possible combustion of organic pollutants which are always present in fossil materials.

The results of the mass spectrometry analysis with the simultaneous measurement of the DTA thermal effects are shown in Fig. 3. The measurements of the molecular weights show only the spectra of 12 and 44 molar masses and put the spectra

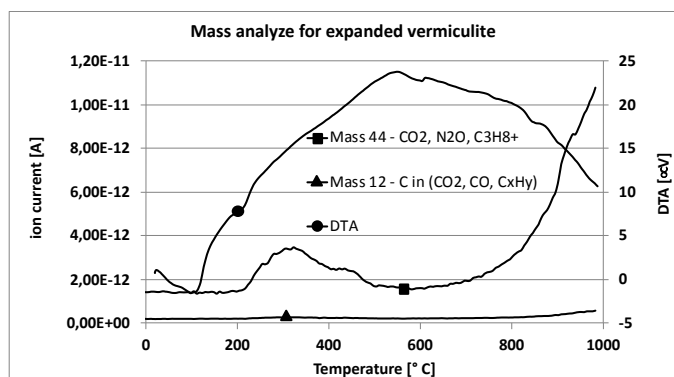

Fig. 3. Molar mass 12 and 44 measurement and DTA heat evolution from expanded vermiculite

in a low range of 10^{-12} . Other spectra at a level of 10^{-13} were recognised as measurement errors or pollutants.

The emission of carbon dioxide is at a very low level of 10^{-12} . It can therefore be associated with the combustion of organic pollutants of expanded vermiculite and with a natural characteristic of clay minerals – CO_2 emission at elevated temperatures. In such a case, the DTA effect is broad and without clear characteristic peaks, as observed in other studies [20,21]. The greatest values of thermal effects can be observed in the temperature range of 550-600°C, which is related to the combination of effects from the combustion of organic pollutants and the effects from dehydroxylation [20,21].

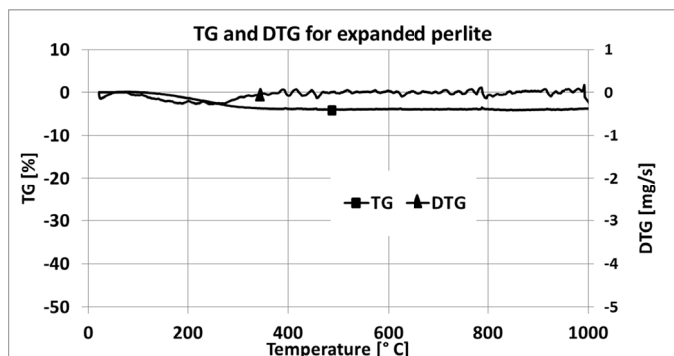

Fig. 4. TG-DTG measurement of expanded perlite

The thermogravimetric analysis results of expanded perlite are presented in Fig. 4. The main weight loss to a level of 4.8% occurs up to a temperature of 230°C, which should be associated with the loss of water consistent with other studies. Expanded perlite does not demonstrate further substantial weight loss along with a temperature increase as it does not include the relevant quantities of intercrystalline water [22].

The research results on the mass spectroscope whilst measuring the DTA thermal effects for expanded perlite are presented in Fig. 5.

The qualitative analysis showed the peaks from 12 and 44 weights at a level of 10^{-12} . The other results were one order of magnitude lower so were not analysed. Expanded perlite as a product resulting from natural volcanic ores has organic

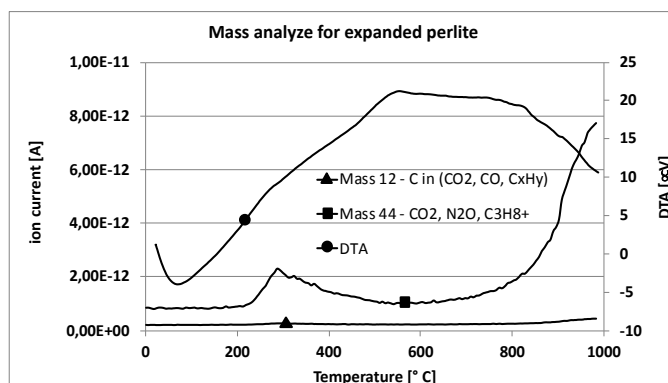

Fig. 5. Molar mass 12 and 44 measurement and DTA heat evolution from expanded perlite

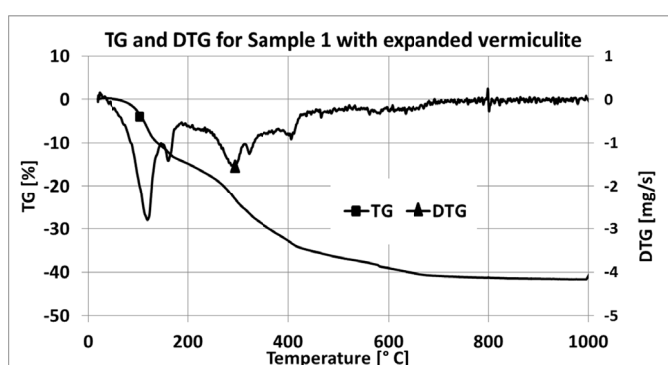

Fig. 6. TG and DTG measurement of Sample 1

impurities which are visible in the carbon dioxide emission and DTA broad effect characteristics [20].

The TG-DTG thermogravimetric test results of Sample 1 are shown in Fig. 6. The first decline in the TG curve is caused by the loss of water from both the paper pulp and the expanded vermiculite. The second stage of the loss of water from the expanded vermiculite, previously discussed and shown in Fig. 2, coincides with the simultaneous degradation of cellulose contained in the composition of Sample 1 and takes place within a temperature range of 250-420°C [23-26]. This stage is associated with the greatest weight loss of up to 36%. Further thermal degradation leads to dehydroxylation, which is shown in a further process of a weight loss up to 42.1%.

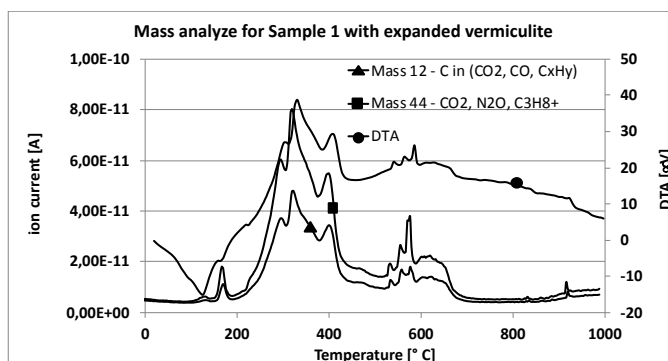

Fig. 7. Molar mass 12 and 44 measurement and DTA heat evolution from Sample 1

The research results on the mass spectroscope while measuring the DTA thermal effects of Sample 1 are presented in Fig. 7. During the thermal degradation of Sample 1, at a level of 10^{-11} , the peaks from 12 and 44 molecular weights were recorded and should be associated with carbon dioxide emission. The peaks from other molecules were in the range of 10^{-13} and were therefore not analysed. On the curve that shows the CO_2 emission from Sample 1, the peaks consistent with the degradation of the cellulose of paper pulp, and which occur in a range of 130-675°C, are observed. The maximum emission of carbon dioxide from the thermal degradation of cellulose is attributable up to a temperature of 320°C, however, a process of the total cellulose pyrolysis estimated in other studies in a range of 450-460°C [23-26] is transferred to a temperature of 588°C.

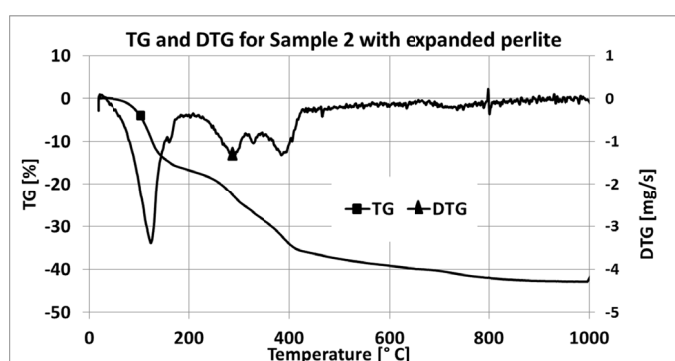

Fig. 8. TG and DTG measurement of Sample 2

The TG-DTG thermogravimetric analysis results of Sample 2 are shown in Fig. 8. The significant decrease in weight on the TG and DTG curves in the first stage, 80-160°C, are caused by a loss of water from both the expanded perlite and paper pulp. The weight loss in this range is 16.6%. Further weight loss should be associated with the thermal degradation of cellulose and occurs in a range of 236-424°C with a maximum clear peak at 284°C. The degradation of most cellulose is completed at 424°C, which is demonstrated by a loss of weight to 34.6%. The sample's further thermal degradation results in a loss of weight to 42.8%, which is caused by dehydroxylation and total cellulose pyrolysis.

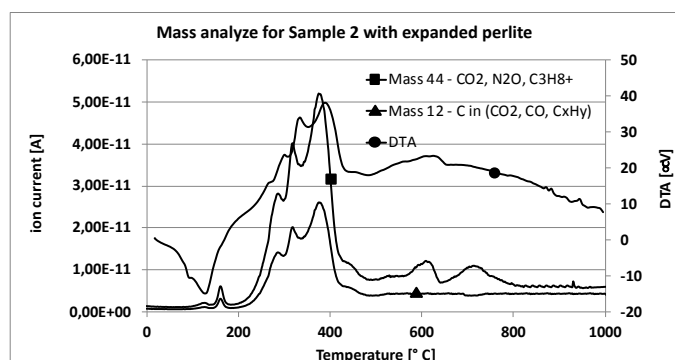

Fig. 9. Molar mass 12 and 44 measurement and DTA heat evolution from Sample 2

In Fig. 9, the mass spectrometer test results with the simultaneous analysis of the DTA thermal effects of Sample 2 are presented. The mass spectrometer measurement results for 12 and 14 molecular weights were presented. Other measurements were in a range of 10^{-13} and were not analysed as they were insignificant for testing. The CO_2 emission visible on the curves of 12 and 44 molecular weights is associated with the combustion of cellulose contained in paper pulp, and mainly occurs up to a temperature of 424°C with its maximum at 381°C related to cellulose pyrolysis. An insignificant part of cellulose is combusted only at 576-743°C, which is connected with the disintegration of aluminosilicate resin being a sealer for the cellulose part. The DTA curve illustrates the CO_2 emission of Sample 2 as the peaks of the thermal effects are consistent with the peaks of the carbon dioxide emission.

4. Concluding summary

The application of expanded vermiculite or expanded perlite, including a binder in the form of inorganic aluminosilicate resin, results in partial cellulose impregnation in the paper pulp mixture with these additives. The effect of such a modification in the composition of paper pulp is the elongation of durability of the cellulose part as the temperature rises. Such mixtures can be considered as short-term thermal barriers as both expanded vermiculite and expanded perlite constitute materials of a high thermal resistance [1,2,22,27]. The mass spectrometer analysis and measurement of the thermal effects showed that, with the exception of carbon dioxide, they do not emit other unexpected toxic compounds during the thermal degradation of the samples, such as Sample 1 and Sample 2.

REFERENCE

- [1] S.A. Suvorov, V.V. Skurikhin, *Refract. Ind. Ceram+*. **43**, 11-12 (2002).
- [2] S.A. Suvorov, V.V. Skurikhin, *Refract. Ind. Ceram+*. **44**, 186-193 (2003).
- [3] X. Zhou, F. Zheng, H. Li, C. Lu, *Energ. Buildings*. **42**, 1070-174 (2010).
- [4] M. Kristkova, Z. Weiss, P. Filip, *Appl. Clay Sci.* **25**, 229-236 (2004).
- [5] V.E. Peletskii, B.A. Shur, *Refract. Ind. Ceram+*. **48**, 356-358 (2007).
- [6] T. Hongo, S. Yoshino, A. Yamazaki, A. Yamasaki, S. Satokawa, *Appl. Clay Sci.* **70**, 74-78 (2012).
- [7] F. A. Mumpton, *PNAS*. **96**, 3463-3470 (1999).
- [8] M. Valaskova, J. Tokarsky, K.C. Barabaszova, V. Matejka, M. Hundakova, E. Pazdziora, D. Kimmer, *Appl. Clay Sci.* **72**, 110-116 (2013).
- [9] H. Zhang, J. Yu, D. Kuang, *Constr. Build. Mater.* **26**, 244-248 (2012).
- [10] Y. Liang, J. Yu, Z. Feng, P. Ai, *Constr. Build. Mater.* **48**, 1114-1119 (2013).

- [11] M. J. Fernandez, M. D. Fernandez, I. Aranburu, *Eur. Polym. J.* **49**, 1257-1267 (2013).
- [12] K.C. Barabaszova, M. Valaskova, *Powder Technol.* **239**, 277-283 (2013).
- [13] H. Zhang, H. Xu, X. Wang, J. Yu, *Constr. Build. Mater.* **47**, 919-926 (2013).
- [14] W. Pichor, A. Janiec, *Ceramic Int.* **1**, 527-530 (2009).
- [15] Z. Zawieja, J. Sawicki, G. Gumienny, A. Sobczyk-Guzenda, *Arch. Foundry Eng.* **14** (3), 123-128 (2014).
- [16] Z. Zawieja, J. Sawicki, *Adv. Sci. Technol. Res. J.* **9** (26), 83-88 (2015).
- [17] Z. Zawieja, J. Sawicki, *Arch. Foundry Eng.* **15** (3), 91-94 (2015).
- [18] Z. Zawieja, J. Sawicki, *Adv. Sci. Technol. Res. J.* **11** (3), 24-30 (2017).
- [19] <https://www.perlipol.com.pl/produkty>
- [20] P. Wyszomirski, K. Galos. AGH, Surowce mineralne i chemiczne przemysłu ceramicznego, Kraków 2007.
- [21] J. Poyato, L.A. Perez-Maqueda, A. Justo, V. Balek, *Clay Clay Miner.* **50** (6), 791-798 (2002).
- [22] A. G. Celik, A. M. Kilic, G.O. Cakal, *Physicochem. Probl. Miner. Process.* **49** (2), 689-700 (2013).
- [23] D.K. Shen, S. Gu, *Bioresour. Technol.* **100**, 6496-6504 (2009).
- [24] C.M. Tian, Z.H. Sh, H.Y. Zhang, J.Z. Xu, J.R. Shi, H.Z. Guo, *J. Therm Anal. Calorim.* **55**, 93-98 (1999).
- [25] F. Shafizadeh, A.G.W. Bradbury, *J. Appl. Polym. Sci.* **23**, 1431-1442 (1979).
- [26] J. Scheirs, G. Camino, W. Tumiatti, *Eur. Polym. J.* **37**, 933-942 (2001).
- [27] Z. Zawieja, J. Sawicki, Polish Patent P. 408770 (2014).