

# Kinetics of eukaryote cells adhesion under shear flow detachment on the PLD deposited surfaces

R. MAJOR<sup>1</sup>, F. BRUCKERT<sup>2</sup>, J.M. LACKNER<sup>3</sup>, W. WALDHAUSER<sup>3</sup>, M. PIETRZYK<sup>4</sup>,  
and B. MAJOR<sup>1\*</sup>,

<sup>1</sup>Institute of Metallurgy and Materials Science PAS, 25 Reymonta St., 30-059 Cracow, Poland

<sup>2</sup> Institut National Polytechnique de Grenoble CNRS-INPG, Minatec-INPG, Grenoble, France

<sup>3</sup>Joanneum Research Forschungsgesellschaft mbH, Laser Center Leoben, A-8712 Niklasdorf, Austria

<sup>4</sup>AGH University of Science and Technology, 30 Mickiewicz Ave, 30-059 Cracow, Poland

**Abstract.** Hybrid PLD method was used for deposition high quality thin Ti, TiN, Ti(C,N) and DLC coatings. The kinetic energy of the evaporated particles was controlled by application of variation of different reactive and non reactive atmospheres during deposition. The purpose was to improve adhesion by building a bridge between the real ceramic coating and the substrate. A new layer composition layout was proposed by application of a buffer, starting layer. Advanced HRTEM investigation based on high resolution transmission electron microscopy was used to reveal structure dependence on specific atmosphere in the reactive chamber. New experimental technique to examine the crystallographic orientation based on X-ray texture tomography was applied to estimate contribution of the atmosphere to crystal orientation. Using *Dictyostelium discoideum* cells as a model organism for specific and nonspecific adhesion, kinetics of shear flow-induced cell detachment was studied. For a given cell, detachment occurs for critical stress values caused by the applied hydrodynamic pressure above a threshold. Cells are then removed from the substrate with an apparent first-order rate reaction that strongly depends on the stress. The threshold stress depends on cell size and physicochemical properties of the substrate, but it is not affected by depolymerization of the actin and tubulin cytoskeleton.

**Key words:** pulsed laser deposition, microstructure, cell adhesion.

## 1. Introduction

In the last twenty years, a lot of experimental and theoretical works have been dedicated to cell adhesion [1–3]. From a biological point of view, understanding of the molecular mechanisms at work when a cell adheres, rolls or slides on passive or reactive substrates is of central importance, since many functions performed by living cells depend on these properties [4].

In eukaryotes, cell adhesion encompasses different levels of complexity [5]. The simplest one consists in the passive interaction between adhesion molecules at the plasma membrane and the cellular physico-chemical environment. A more complex level involves the specific cell response to the engagement of its adhesion molecules into non-covalent complexes, which in turn, actively modifies the adhesion process. At the molecular level, the formation of adhesive bonds between a cell and external molecules is directly controlled by the different cytoskeleton networks and by the membrane traffic of the adhesion proteins. Considering a various physiological task(s), cells are committed to, which require localized reinforcement or reduction of cell adhesion strength. It is therefore not surprising that changes in cell adhesion accompany many cellular processes. From a physico-chemical point of view, the bio-adhesion involves three components: cells, solid substrate

and liquid medium [6]. The relevant microorganism properties are the cell surface hydrophobicity and charge, cell size and possession of flagella and pili [7, 8].

The goal of the present work was to study kinetics of the cell adhesion with respect to surfaces of thin coatings of biological materials by application of cell detachment assay.

## 2. Experimental

**2.1. Materials and methods of examination.** Pulsed laser deposition (PLD) method was selected for deposition of Ti, TiN, Ti(C,N) and DLC coatings on metallic titanium substrate. The kinetic energy of the evaporated particles was controlled by the application of the different reactive and non reactive atmosphere. Deposition was performed in its gradient change. The purpose of this solution was to improve adhesion by building a bridge between the ceramic coating and the applied substrate. Titanium nitride is a well known ceramic material which is widely used in medical applications, however, it is currently observed that carbide and carbonitride coatings become popular as well. PLD system, working with Nd:YAG laser was used in experiments. The main deposition parameters are presented in Table 1.

\*e-mail: nmmajor@imim-pan.krakow.pl

Table 1  
PDeposition parameters by application of PLD system

Symbol	Coating	Deposition time/ Gas flow during buffer layer deposition	Gas flow during main coating deposition
1	TiN 500 nm TiN	4' 0sccm Ar 4' 10 sccm Ar 5' 30 sccm Ar	60' 30sccm N2
2	TiCN-3 500 nm Ti(C,N)	4' 0sccm Ar 4' 10 sccm Ar 5' 30 sccm Ar	60' 29.5sccm N2+0.5sccm C2H2
3	TiCN-5 500 nm Ti(C,N)	4' 0sccm Ar 4' 10 sccm Ar 5' 30 sccm Ar	60' 25sccm N2+5sccm C2H2
4	DLC 500 nm DLC	4' 0sccm Ar 4' 10 sccm Ar 5' 30 sccm Ar	60' 30sccm Ar
5	Ti 500 nm Ti	4' 0sccm Ar 4' 10 sccm Ar 5' 30 sccm Ar	60' 30sccm Ar

There is a strong interaction between the chamber environment and the shape of the plasma flow. In vacuum, the plasma plume has sphere-like shape. Kinetic energy is high but there is endanger of non uniform particle distribution. Variation of the atmosphere in the reactive chamber by the neutral gas application, changes the plasma flow shape and decreases the energy of particles. This influences the particle distribution to be more uniform. Figure 1 presents a high resolution transmission electron microscopy results obtained in the selected area in the buffer layer.

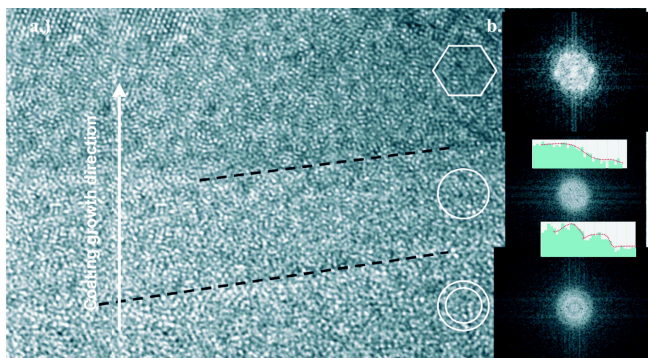

Fig. 1. High Resolution Transmission Electron Microscopy results in the selected area in the buffer layer

The crystallization degree transforms from a fully amorphous (for 0 and 5 sccm gas flow) to crystallised (for 30 sccm gas flow). This is proved by the Fourier transform of electron diffraction. On the basis of the background measurements, the influence of the substrate was examined. The initial layer, deposited near the vacuum conditions is more crystallised than the upper ones (5 sccm).

**2.2. Cell detachment.** Using *Dictyostelium discoideum* as a model organism of specific and nonspecific adhesion, the kinetics of shear flow-induced cell detachment was studied. One of the difficult aspects of the cell mechanics is the complex shape cells. Cytoskeleton-disrupting agents such as cytochalasin. A were used to convert *D. discoideum* cells into a more symmetrical structures, looking like liposomes (Fig. 2).

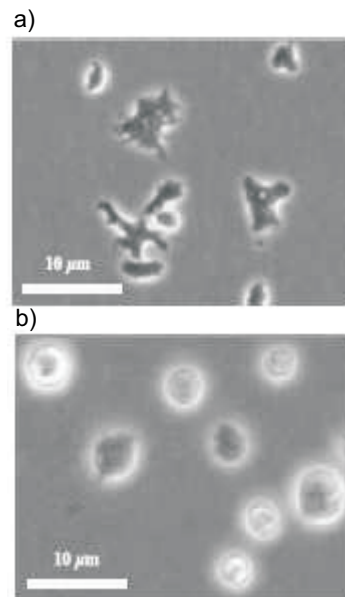

Fig. 2. Control of cell shape by the actin cytoskeleton; a) Control cells exhibit many pseudopods and filopods, b) CIPC-treated cells, where the actin cytoskeleton has been depolymerized, have a more regular shape after Ref. 9

A radial hydrodynamic flow is generated between the stainless steel disk and the examined plate on which cells adhere. Cells were re-suspended in the Sørensen buffer and spread evenly at a density of 300 cells/mm<sup>2</sup>. The shear stress induced by the flow on the plate decreases as 1/r. The layout of the experimental system is presented in Fig. 3.

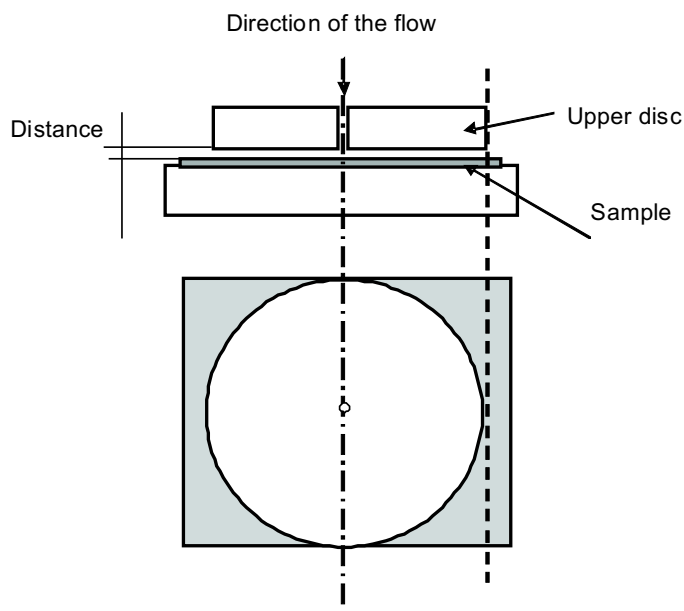

Fig. 3. The layout of the experimental system

For a given cell, detachment occurs for values of the applied hydrodynamic stress above a threshold. Cells are removed from the substrate with an apparent first-order kinetics

*Kinetics of eukaryote cells adhesion under shear flow detachment on the PLD deposited surfaces*

strongly depends on the applied stress. The stress threshold depends on the cell size and the physico-chemical properties of the substrate, but it is not affected by depolymerization of the actin and tubulin cytoskeleton. In contrast, the kinetics of cell detachment is almost independent of the cell size, but it is strongly affected by modification of the substrate and the presence of an intact actin cytoskeleton. Contact angle of liquid in relation to the Sørensen Buffer is presented in form of diagram in Fig. 4.

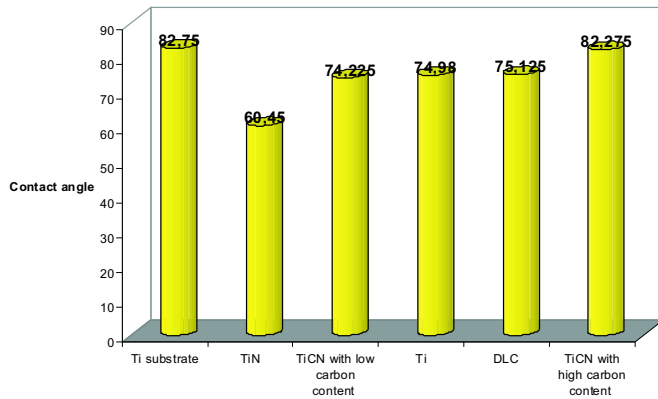

Fig. 4. Values of the contact angle of Sørensen Buffer to the selected layered materials

After the test, samples were given under the fluorescence microscopy observation. In use of Image-ProPlus software, the cells were counted and on basis of the received values critical shear stress was calculated in use of the following formula:

$$\sigma_{50\%} = \frac{3D\eta}{\pi r_{50\%}e^2}$$

where  $D$  – flow rate,  $\eta$  – Sørensen buffer viscosity,  $r$  – distance from the 50% detached cells,  $e$  – distance between discs.

In most of experiments, the flow rate was selected so that the cell density on the plane after exposure time caused the flow of the cells over the center of the disk. Percentage of the detached cells was obtained by normalization of the detached-cell density to the cell density on the plane recorded outside the disk.

The experiment was performed in different periods to set the time where the stagnation point would be reached (the function would suit each other). The diagrams present the shear stress function for the substrate and regarded coatings (Figs. 5–8). For the substrate (Fig. 5) and titanium nitride coating (Fig. 6), the stagnation point was not reached. Thus the shear stress should be applied for longer times to determine the detachment kinetics. For titanium carbonitride (Fig. 7), there was no clear difference between 5 and 10 min, thus steady state is almost reached.

Unfortunately, the applied flow conditions allowed to determine steady conditions only for one coating (Fig. 8). The percentage of the detached cells was recalculated as a function of shear stress, since not so many cells were detached. The initial density from the distribution of remaining cells was taken. In summary, the total values of the shear

stress was collected and compared. The diagram presents the total classification of the shear stress which has been detected between the coating and the biological cell (Fig. 9).

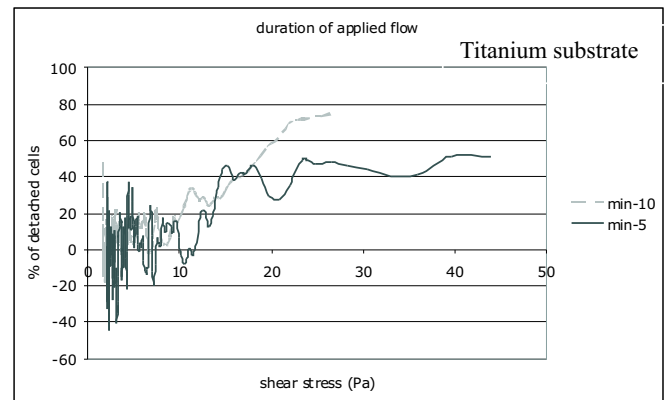

Fig. 5. Cell detachment kinetics for titanium substrate in two exposition times

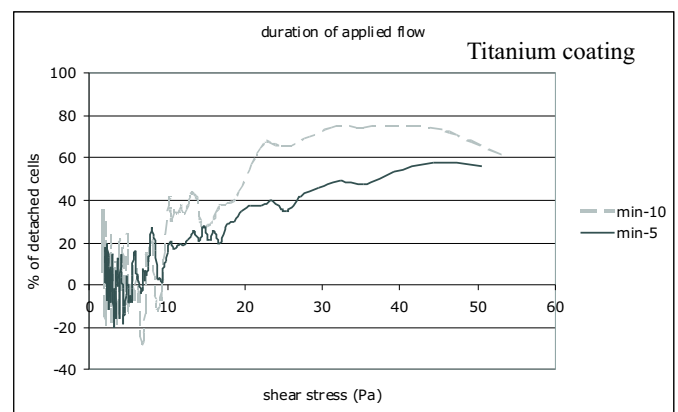

Fig. 6. Cell detachment kinetics for titanium nitride coating in two exposition times

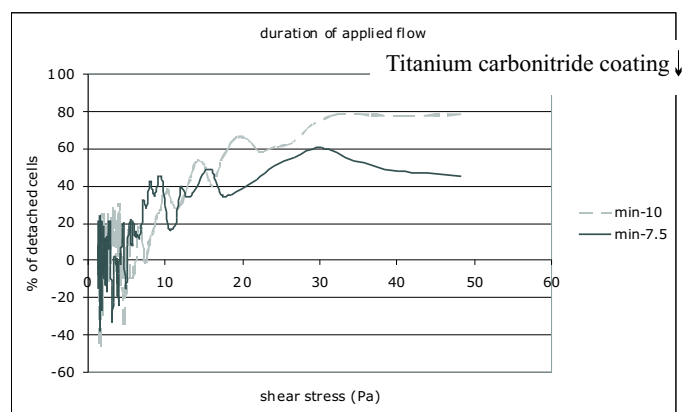

Fig. 7. Cell detachment kinetics for titanium carbonitride with low carbon content coating in two exposition times

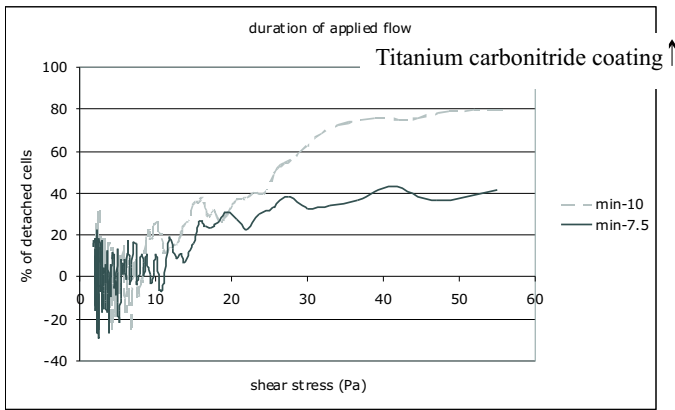

Fig. 8. Cell detachment kinetics for titanium carbonitride with high carbon content coating in two exposition times

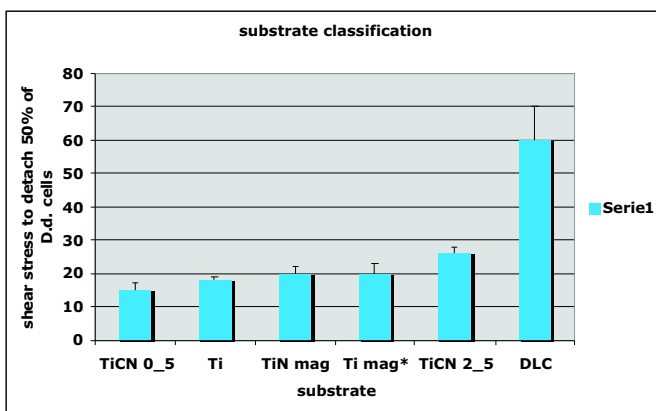

Fig. 9. Total classification of the shear stress to detach 50% of cell population

The main values and remarks of the calculation cell detachment kinetics are presented in Table 2. The character of the adhesion changed depending on the coating material on which cells are deposited. Results are presented on the fluorescence microscopy images (Figs. 10–12).

Table 2  
Results of the cell detachment calculations

Substrate coatings (by order of shear stress detaching 50% of the cells)	C		
	value	uncertainty	remark
TiCN 0_5	15	2	
Ti	18	1	
TiN mag	20	2	
Ti mag*	20	3	problem with 5 min flow experiment
TiCN 2_5	26	2	
DLC	60	10	

The characteristic shape was observed for titanium carbonitride deposited at the low carbon content conditions (Fig. 11a). Cells formed adhesion groups. The reason of the observed behavior of the cells is still under examination. One of the possible explanation could be apoptosis, which could be

associated with the lost of symmetry of the crystallographic built.

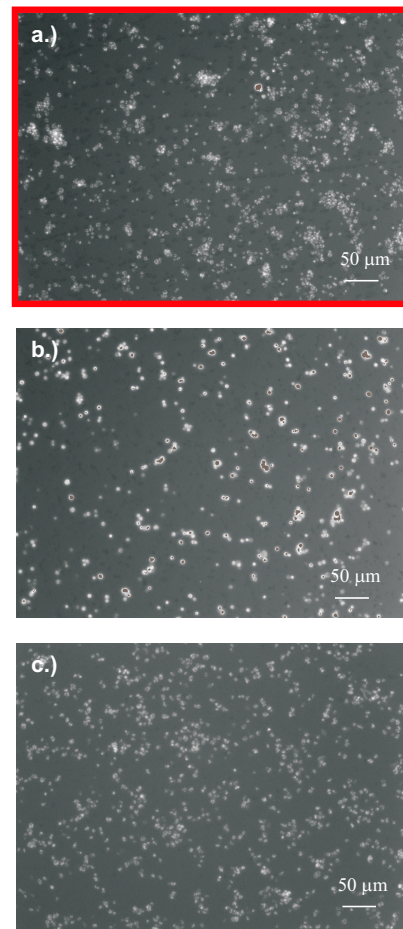

Fig. 10. Cell distribution: a) cells deposited on Ti substrate; b) cells deposited on Ti coating; c) cells deposited on TiN coating

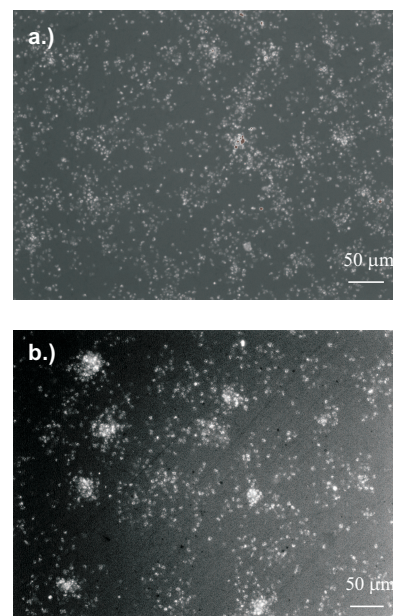

Fig. 11. Cell distribution: a) cells deposited on Ti(C,N) coating with low carbon content; b) cells deposited on Ti(C,N) coating with high carbon content

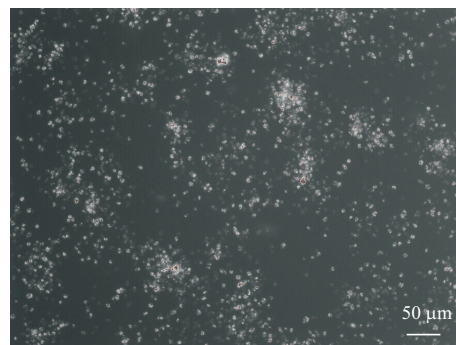

Fig. 12. Cell distribution on DLC coating

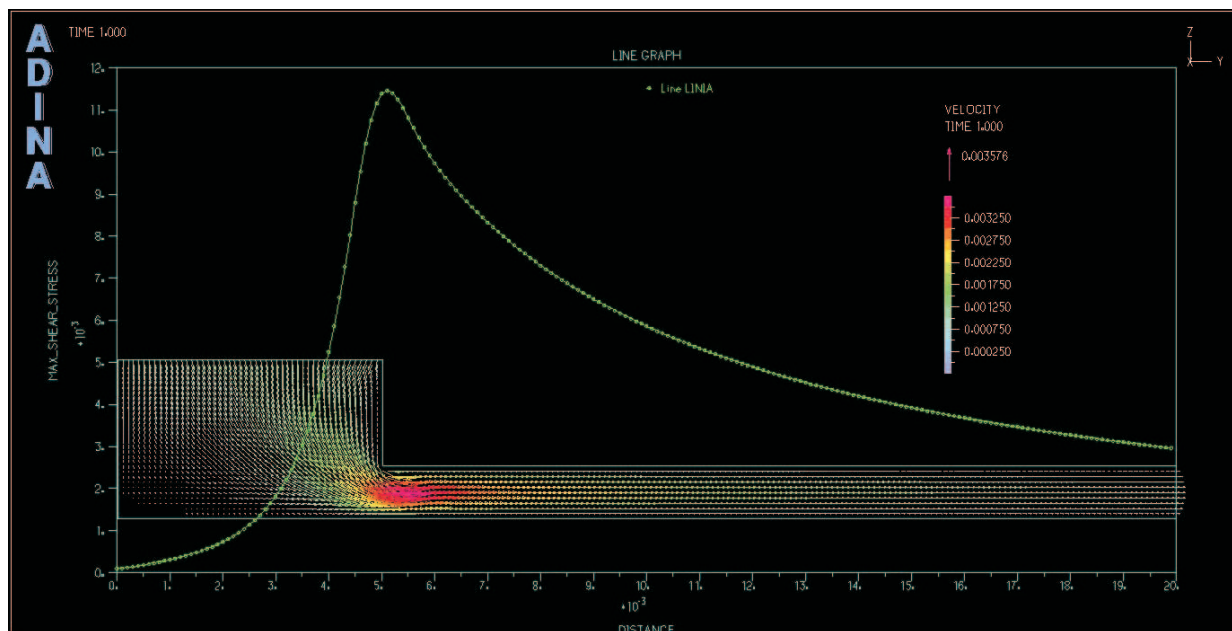

Fig. 13. Finite element modeling of the cell detachment experiment

Similar, but less visible cell behavior was observed for DLC like coating (Fig. 12). In fact DLC structure was not successfully achieved and it should be regarded as a graphite coating.

**2.3. Finite element modeling.** On the basis of the real cell detachment experiment, a finite element simulation was done. The real material properties were considered for titanium nitride. A medium viscosity was introduced for the calculations as well. The highest shear stress was estimated for the region of the radius of the whole pierced in the center of the upper disc. Shear stress distribution presented in the FEM illustration relatively is similar to the results obtained experimentally (Fig. 13).

### 3. Conclusions

The following main conclusions were possible to be formed on the basis of the experimental results:

- application of the gas in the reactive chamber could give possibilities to control the crystallization degree in the buffer layer,

- cell distribution depends on the applied material and crystallographic orientation strength,
- critical shear stress for cell detachment depends strongly on the grain size of the coating material.

**Acknowledgments.** The work was supported by the N507 136 32/396 project and Knowledge-based Multicomponent Materials for Durable and Safe Performance KMM NoE project FP6 provided by the Polish Ministry of Science and Higher Education. Financial support by the Austrian Federal Ministry of Traffic, Innovation and Technology, the Government of Styria and the European Union is highly acknowledged.

### REFERENCES

- [1] G.I. Bell, "Models for the specific adhesion of cells to cells", *Science* 200, 618–627 (1978).
- [2] E. Evans and K. Ritchie, "Dynamic strength of molecular adhesion bonds", *Biophys. J.* 72, 1541–1555 (1997).
- [3] P. Bongrand, "Ligand-receptor interactions", *Rep. Prog. Phys.* 62, 921–968 (1999).

R. Major, F. Bruckert, J.M. Lackner, W. Waldhauser, M. Pietrzyk, and B. Major

- [4] D. Garrivier, E. D'ecave, Y. Brechet, F. Bruckert, and B. Fourcade, "Peeling model for cell detachment", *Eur. Phys. J. E* 8, 79–97 (2002).
- [5] F. Bruckert, E. De Cave, D. Garrivier, P. Cossion, Y. Brechet, B. Fourcade, and M. Satre, "Dictyostelium discoideum adhesion and motility under shear flow: experimental and theoretical approaches", *J. Muscle Research and Cell Motility* 23, 651–658 (2002).
- [6] M. Demilly, Y. Brechet, F. Bruckert, and L. Boulang'e, "Kinetics of yeast detachment from controlled stainless steel surfaces", *Colloids and Surfaces: Biointerfaces B* 51, 71–79 (2006).
- [7] M.C. van Loosdrecht, W. Norde, and A.J. Zehnder, "Physical chemical description of bacterial adhesion", *J. Biomater. Appl.* 5, 91–106 (1990).
- [8] S. Vatanyoopaisarn, A. Nazli, C.E. Dodd, and C.E. Rees, "Effect of flagella on initial attachment of *Listeria monocytogenes* to stainless steel", *Appl. Environ. Microbiol.* 66, 860–863 (2000).
- [9] E. Décavé, D. Garrivier, Y. Bréchet, B. Fourcade, and F. Bruckert, "Shear flow-induced detachment kinetics of dictyostelium discoideum cells from solid substrate", *Biophysical J.* 82, 2383–2395 (2002).