

APPLICATION OF TWO ADVANCED VISION METHODS BASED ON STRUCTURAL AND SURFACE ANALYSES TO DETECT DEFECTS IN THE ERICHSEN CUPPING TEST

Due to the wide range of various sheet metal grades and the need to verify the material properties, there are numerous methods to determine the material formability. One of them, that allows quick determination of sheet metal formability, is the Erichsen cupping test described in the ISO 20482: 2003 standard. In the presented work, the results of formability assessment for DC04 deep drawing sheet metal were obtained by means of the traditionally carried out Erichsen cupping test and compared with the results obtained by using two advanced methods based on vision analysis. Application of these methods allows extending the traditional scope of analysis during Erichsen cupping test by determination of the necking and strain localization before fracture. The proposed methods were compared in order to dedicate appropriate solution for the industrial application and laboratory tests respectively, where the simplicity and reliability are the mean aspects need to be considered when applied to the Erichsen cupping test.

Keywords: defect detection, Erichsen cupping test, laser speckle, vision system

1. Introduction

In the era of high diversity of available sheet grades and their manufacturers, there is a need to quickly and accurately determine the suitability of the batch of sheet metal for metal forming processes. To this end, many different methods have been developed to enable this task to be carried out. One of such methods is the cupping test invented over one hundred years ago by A.M. Erichsen. It was the first test method for assessing the quality of sheet metal [1]. Today the International Standards Organization (ISO) [2] recommends the Erichsen cupping test method. It is a relatively simple test applicable to industrial conditions. It consists in inserting a spherical punch into the tested sheet metal until a defect occurs in the form of a crack. The depth of the obtained cavity given in mm is the result of this test and it is the so-called Erichsen Number (IE). This test allows you to quickly verify the formability of the tested sheet. Although excellent in industrial conditions, the Erichsen cupping test in a standard form does not enable tracing the defect stages. Such tracing of defects opens up the possibility of not only estimating sheet metal formability, but also distinguishing its grades. As the research shows and which is rather intuitive, there are clear discrepancies in the height of the samples between the occurrence of localized necking and cracking for various grades of sheet metals [3].

Over the years, significant progress has been made in methods that allow advanced analysis of the sheet metal deformation

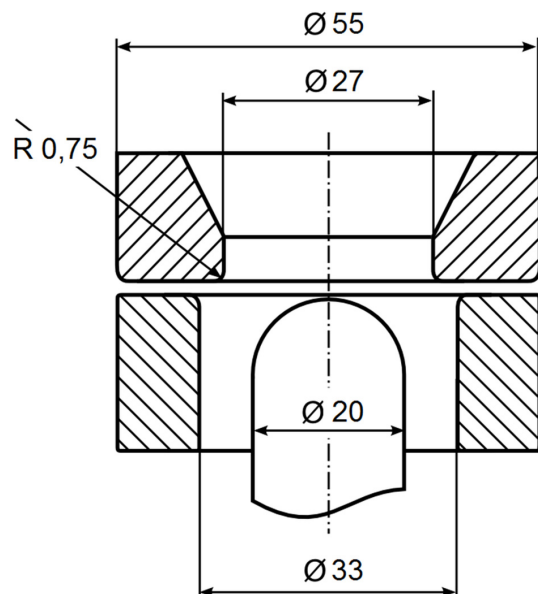

Fig. 1. Dimensions of tools in the Erichsen cupping test

process. In attempts to determine forming limit diagrams [4], the methods of vision image analysis based on Digital Image Correlation (DIC) are used [5]. They allow to precisely determine the level of deformation accompanying the resulting defect, as well as detect strain localization during forming. Advanced methods based on the analysis of interference of coherent light beams on the surface of the examined sheet (ESPI) [6], in turn,

* WARSAW UNIVERSITY OF TECHNOLOGY, DEPARTMENT OF METAL FORMING AND FOUNDRY, 85 NARBUTTA STR., 02-524 WARSZAWA, POLAND

** KIELCE TECHNICAL UNIVERSITY, FACULTY OF MANAGEMENT AND COMPUTER MODELLING, 7 TYSIĄCLECIA PAŃSTWA POLSKIEGO AV., 25-314 KIELCE, POLAND

Corresponding author: cjasins1@wip.pw.edu.pl

allow measurements of small displacements with resolutions reaching values below the wavelength of the applied light. Not all available tests and measurement methods are, however, suitable for use in industrial conditions due to the complexity, the time required to perform them, or the obtained measurement accuracy. In this study, the authors focused on combining advanced vision analysis with a simple test called the Erichsen cupping test. Vision methods proposed and compared by the authors have extended the traditional scope of analysis during Erichsen cupping test by determination of the necking and strain localization before fracture.

2. Methods used in the research

A comprehensive research stand was prepared based on the use of a vision system together with the proposed computational technique for the analysis of recorded images of the specimens during deformation process. In particular, methods using image processing (called Optical Flow) have been described that allow for qualitative analysis of subsequent deformation stages during cupping process, previously applied to the analysis of the hydraulic bulging [7] and cutting process [8]. In addition, measurements of sheet deformation were made based on the method using the laser speckle phenomenon [3]. The aim was to develop a comprehensive method of comparing the forming limits of deformation of sheet metal by means of spherical punch (Erichsen cupping test) under industrial conditions, where traditional techniques based on detection of cracking by visual or energy methods are insufficient.

The deep drawing steel DC04 (Tab. 1) in the form of 90 mm wide strips with thickness of 1 mm were used in the research.

All strips used with the previously described methods were cut from one sheet of metal. An exemplary strip with cups made during tests is shown in Fig. 2.

TABLE 1

Chemical composition of deep drawing steel DC04

C [%] max.	Mn [%] max.	P [%] max.	S [%] max.
0.08	0.40	0.03	0.03

2.1. Visual and vision assessments based on stochastic grids

The test stand is shown in Fig. 3a with indication of its basic elements: Erichsen type machine for performing cupping tests, vision system, illumination and data acquisition part for measurement of the height of the DC04 sheet metal (1 mm in thickness) subjected to cupping process. The special design of the specimen holder (Fig. 3b) allows for the observation of the stochastic grid on the specimen surface (Fig. 3c). The camera recording the image of the specimen surface was placed on the machine's control panel by means of magnetic holders. In order to guarantee the proper conditions for image recording and to obtain adequate illumination of the examined specimen surface, diffused illumination was obtained thanks to the spherical dome attached to the lens. Intensity of strong LED lighting was adjusted automatically. The control of the measurement system was carried out using a program written in the Matlab/ Simulink environment.

The acquisition system of measurement data enabling the collection of information in the form of an image and the instan-



Fig 2. Sheet strip with cups made during tests

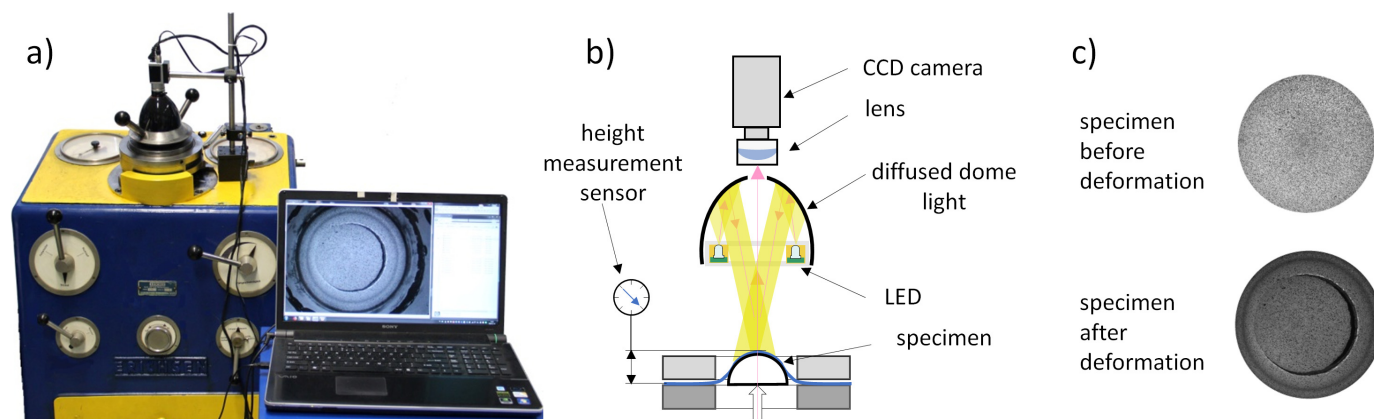

Fig. 3. Research method: a) test stand (Erichsen), b) schematic presentation of the measurement system, c) specimen images before and after the cupping process

taneous height of the deformed sheet metal was synchronized. Application of this measurement system allowed for automatic recording of the course of the cupping process. Control of the measuring system was carried out from the Matlab / Simulink level enabling the control of external devices such as: camera, lighting and height measurement. The developed vision system is based on the Basler camera (type: acA 1300-30 gm supporting Gigabit Ethernet transfer), lens (dedicated to machine vision with focal length: 16 mm and maximum aperture ratio: 1:1.4), LED lighting type ZLED CLS 9000 (equipped with 9 mm fiber optic output with 900 lumens) and Mitutoyo's height measurement sensor (type: digital sensor with a resolution of 0.001 mm and a measuring range of 25.4 mm). Digital data from camera and sensor are sent to the computer via two ports: Ethernet and USB, and then they are saved in the system's memory.

2.1.1. Numerical methods of displacement measurement

Numerical image processing using the correlation function is a visual method used to investigate the extent of surface deformation [9,10]. The essence of this method is to maximize the normalized correlation coefficient. Calculations are made for images saved in shades of gray with specified subareas and marked center points. Determination of the displacement values takes place in relation to two neighboring images. The condition for the implementation of calculations is to obtain high-resolution images that allow distinguishing the analyzed image features (stochastic grid). The resolution of the stochastic grid patterns must be closely related to the resolution of the camera recording the image. Generally, the Optical Flow (OF) approach is defined as displacement field represented by a brightness pattern over the image. The proposed solution is based on a special correlation strategy, which leads to short time of analysis. Horn and Schunck introduced it the first time in the early 80's [11]. Additional smoothness constraint (SC) enables the flow field to be smooth over the whole image. The method assumes, that the brightness intensity of the object point will be the same in the two images, and the displacement for the neighbors is approximate. Therefore, to compute the optical flow between two images the following equation need to be solved:

$$I_x u + I_y v + I_t = 0 \quad (1)$$

where:

- I_x , I_y , and I_t are the spatiotemporal image brightness derivatives,
- u is the horizontal optical flow,
- v is the vertical optical flow.

The values of displacements in the form of vectors u and v for each selected point of the stochastic grid are determined as the difference of pixel coordinates values for the center points of the sub-areas of the image before and after the deformation. Analysis of sub-areas and tracking them to measure displacements

in the correlation method is used to obtain high measurement accuracy.

2.1.2. Loss of stability in the Erichsen cupping test

Determining loss of stability in the cupping test requires information specifying the concept of loss of stability. In the uniaxial tensile test this concept is very widely described and refers to the moment of necking occurrence in the cross-section. This phenomenon is associated with the appearance of maximum tensile force and puts an end to the uniform elongation.

In the case of the cupping test, the deformation is not so unambiguous and this results in the possibility of different interpretations of the concept of loss of stability. This ambiguity is additionally increased by the influence of friction on the contact surface between the punch and the sheet metal, affecting the possibility of different deformation conditions. From here it can be assumed that during deformation with a metal punch, a temporary loss of stability due to the disturbance of the friction conditions and the occurrence of increased deformations in any area of the cup may occur. However, this is a different case than in the hydrostatic or gas bulging, where the loss of stability of the cup as a whole occurs [12], and finally a spherical shape of the cup is lost.

Another known form of the loss of stability during the cupping test is connected with the amount of energy (delivered by a force acting on the punch), needed to carry out the process. Ultimately, however, the local loss of stability preceding the cracking of the material should be decisive in the deformation processes. It happens at the time of necking, which gradually deepens, resulting in a fracture of the material.

Finding the right technique to determine the moment of local loss of stability have been the subject of many publications [13]. The authors in this publication try to present a qualitative assessment of individual stages of the cupping process and indicate the method for their proper identification. The proposed method of numerical analysis of images recorded during cupping test is based on a comparison of two consecutive images. This allows you to observe during the course of deformation a particular type of area (with the outline of a circle), without displacements (rigid). Its displacement during the process allows you to follow the individual stages of the process and recognize them. In the initial stage of the process, during the contact of the punch with the material, a distinctive displacement increment is apparent, eventually forming a small, circular dead zone (Fig. 4a). During the further deformation process, one can observe a momentary deviation from the equilibrium (Fig. 4b) understood as a previously described loss of stability resulting from different deformation conditions. Ultimately, however, the decisive stage is the local loss of stability visible through the dynamic displacement of the rigid area in the final deformation stage towards the edge of the sample (Fig. 4c). This stage leads to the concentration of strains, which is manifested by thinning the wall (the occurrence of a necking) and finally fracture occurs (Fig. 4d).

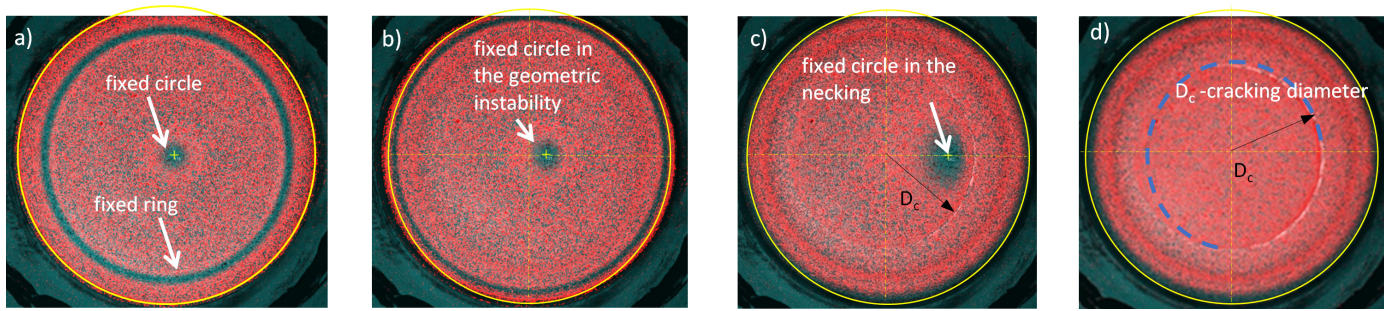

Fig. 4. Example of recognition of individual stages of the process: a) formation of rigid areas, b) local instability, c) necking, d) fracture

2.1.3. Visual assessment for specimens without any grid on surfaces

In order to make visual assessment, images of the specimen surfaces (without stochastic grids) were recorded together with the registration of their heights. The assessment of two stages corresponding to the formation of necking and cracking was made. It was assumed that a local loss of stability leads to necking and decreasing the thickness (no visible crack line). In contrast, the moment of cracking was taken immediately before the separation of the material. The images along with the values of the cup heights are shown in Fig. 5. The subsequent images indicate the concentration of deformations in the area of the emerging cracking and clearly confirms the influence of friction on the reduction of strain intensity outside this area (Fig. 5b). This leads to the possibility of observing an intermediate state and tracing the material separation mechanism (Fig. 5c). Obtained height measurement results for the performed visual tests concern the stages of necking and cracking. Finally the results were averaged for ten measured specimens (Fig. 5d).

2.1.4. Video assessment based on specimen surfaces with stochastic grids

Stochastic grids were obtained by means of spray paints, using the white color for the grid background and black one for the measuring points. The use of white background allows to standardize the surface of the specimen, which changes its surface structure during deformation. In turn, the creation of measuring points takes place by randomly dispersed black paint on the white surface of the specimen. So we get a stochastic grid with a large number of measuring points scattered over the whole specimen surface. The prepared specimens were subjected to the Erichsen cupping test with simultaneous registration of images and height changes. Tracking individual image frames was the basis for the assessment of two deformation stages. In the first part of the research, mean values of heights corresponding to necking and cracking were determined by visual assessment (Fig. 6). Visible under magnification, the less intense contours of microcracks, as compared to specimens without mesh, are the result of the applied layer of paint. In this way, some information on the influence

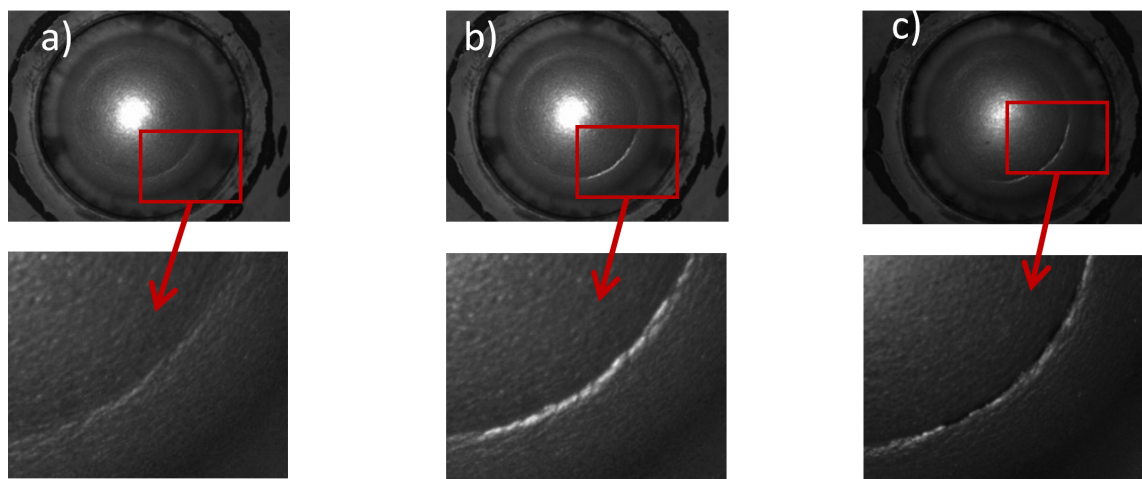

d)

necking	13.02	12.59	12.55	12.45	12.50	12.25	12.21	12.36	12.23	12.41	12.46
cracking	13.30	12.71	12.73	12.49	12.66	12.43	12.35	12.59	12.41	12.58	12.62
specimen	no.1	no. 2	no. 3	no. 4	no. 5	no. 6	no. 7	no. 8	no. 9	no. 10	average

Fig. 5. Cup images and heights [mm] for specimens without any grid: a) necking, b) cracking stage, c) separation of sheet metal, d) height measurement results

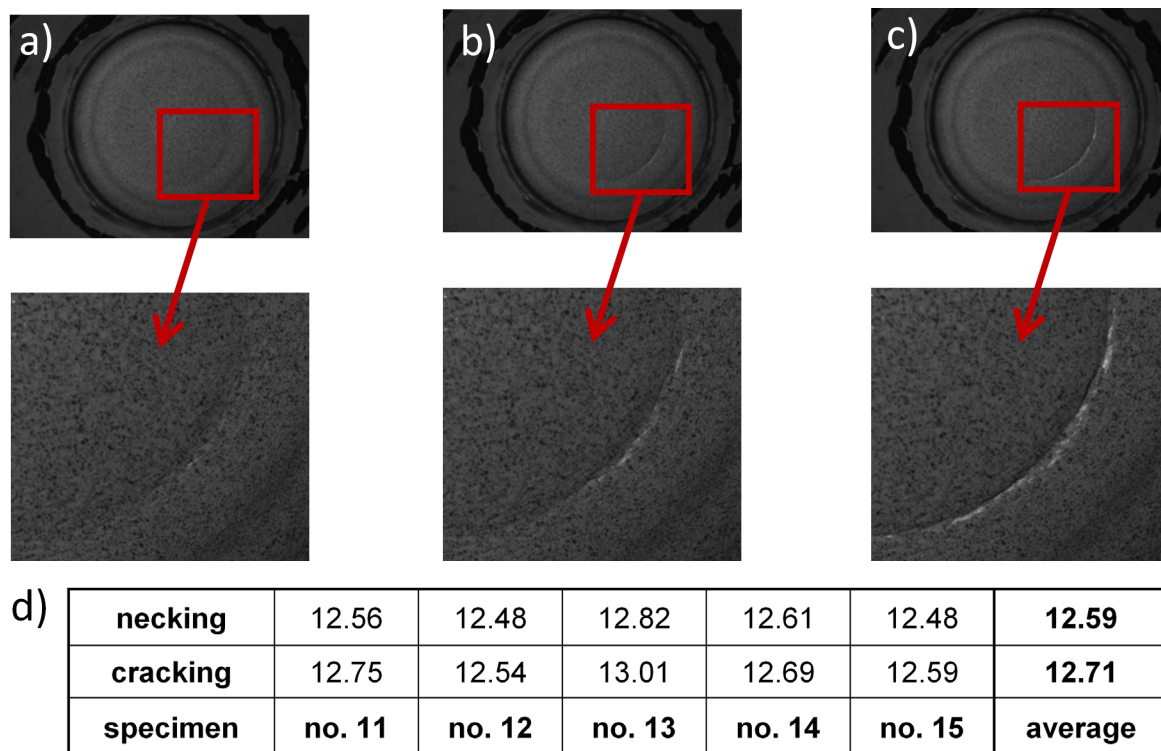

Fig. 6. Cup images and heights [mm] for specimens with stochastic grids: a) necking, b) cracking stage, c) separation of sheet metal, d) height measurement results

of paint on the friction effect during specimen deformation was obtained. Average heights determined for specimens with stochastic grids were higher by about 0.1 mm in both stages (necking and cracking) as comparing with specimens without any grid.

In the second part of the research, subsequent images of the specimens were subjected to video analysis using the described Optical Flow method. For this purpose, a pixel image (red color) representing the moving points was superimposed on the images. This resulted in a graphical representation (qualitative assessment) of circumferential displacements in subsequent deformation stages, Fig. 7. By tracing the subsequent images described in this way, one can notice the occurrence of two characteristic areas without circumferential displacements (distortions) – the first area with the circle outline formed centrally under the punch and the second area with the ring contour lying on the circumference of specimen.

Each of these areas represents different material behavior. The ring contour represents the division of the specimen into areas, one of which is characterized by positive and the other by negative strains. In turn, the centrally formed circle under the punch reflects the character of changes taking place during

deformation, where the deflection of this area from the level of equilibrium means the temporary or local loss of stability described earlier in the deformation mechanism during the cupping with a punch. Therefore, when measuring the center of the moving circle (with respect to the symmetry axis), it is possible to follow the subsequent stages of the process resulting from changes in the distribution of peripheral displacements (deformations). Fig. 8 shows the path of the center of the circular rigid region for three deformed specimens. The points A-G were estimated based on the experimental investigation using visual surface analysis (i.e. samples without the grid) and the rigid area path characteristics. As you can see, a temporary loss of stability may occur during the process, which remains without any significant influence on the later behavior of the material, as is the case during the course described from 4 to 8 mm of height changes. On the other hand, two characteristic points of C and D (determining identical height values for three tests), showing intensification of motion towards the cracking area, are decisive for the material's behavior.

Fig. 9 further shows the surfaces of the deformed cup corresponding to the points A-G of Fig. 8. They represent the

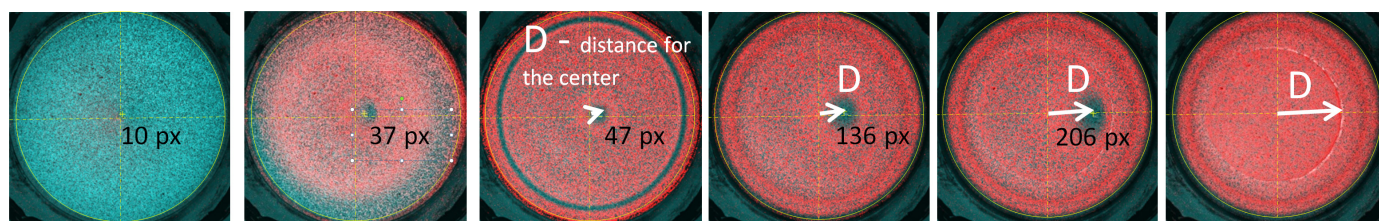

Fig. 7. The course of the deformation process obtained by using Optical Flow function

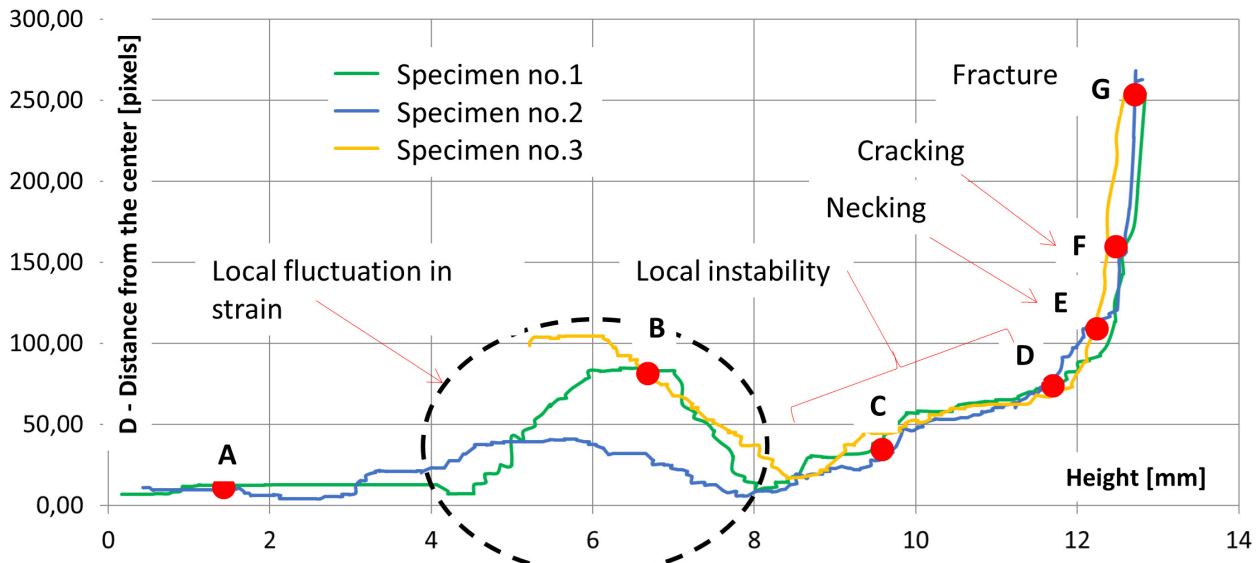

Fig. 8. Description of individual stages of the deformation process with the use of vision assesment

initial (A and B) and final (E, F and G) deformation stages, Fig. 9a. The enlargement of the areas in the final deformation stage shows strain concentration (E), cracking (F) and material separation (G), Fig. 9b. The corresponding heights of cups for the necking and final fracture stages are equal to 12.45 mm and 12.75 mm respectively.

2.2. Defect detection based on laser speckle analysis

Another method used to analyze the course of the Erichsen cupping test was the method based on the laser speckle phenomenon, described in detail in [13]. The basis of this method is the analysis of laser speckle registered on images recorded by camera. Laser speckle allowed following the changes occurring on the surface of the deformed material. Based on characteristic points on laser speckle activity graph (Fig. 13a) it is possible

to indicate the moment of contact between the punch and the sheet, loss of stability, necking and fracture. The scheme of the vision system used in the research has been presented in Fig. 10.

The vision system is equipped with a camera, laser line illumination, prism for additional height measurement and PC computer for image and punch displacement registration. The analysis took place after the process, but it was also possible to carry it out online. The laser illuminator generates a coherent light line passing through the central part of the sample (Fig. 11a). On the basis of the registered images sequence, an analysis of the texture changes created by the laser speckle on the A-C section is carried out. As a measure of changes in the laser speckle image (activity) in the individual points of the sample surface, the digital image correlation between subsequent images is used. The image correlation was carried out for blocks of 15×15 pixels. Fig. 11b shows the course of the laser speckle activity at three selected points of the surface. Higher values in the graphs mean

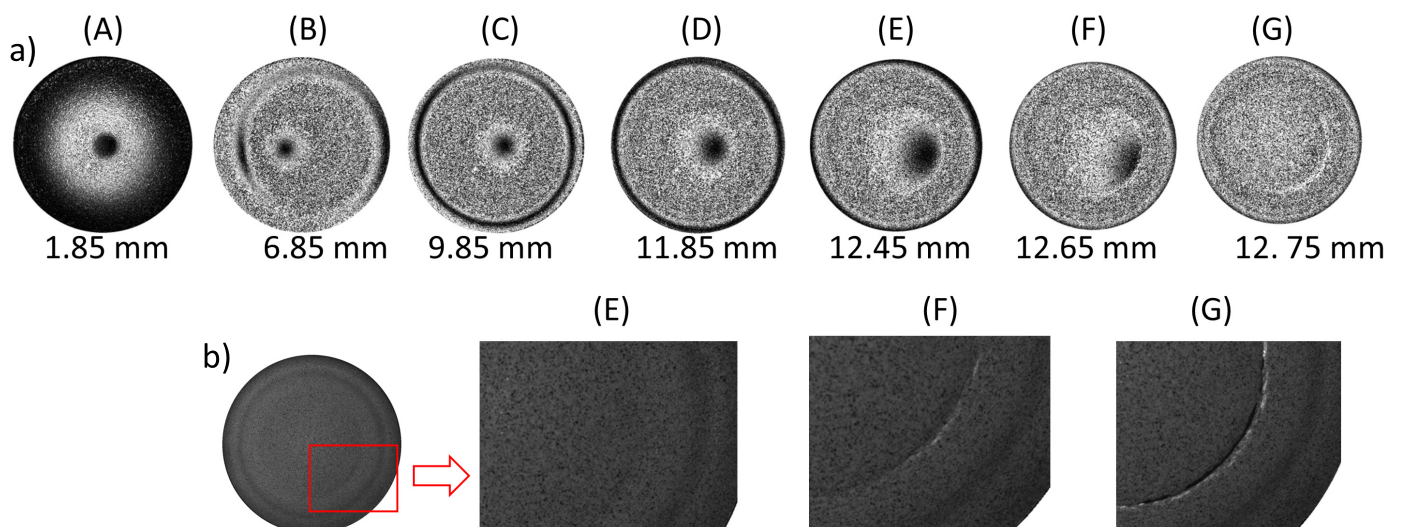

Fig. 9. Graphical presentation of changes in the deformation of the cup: a) measured heights, b) selected areas (enlarged) for the final stages of the cup deformation

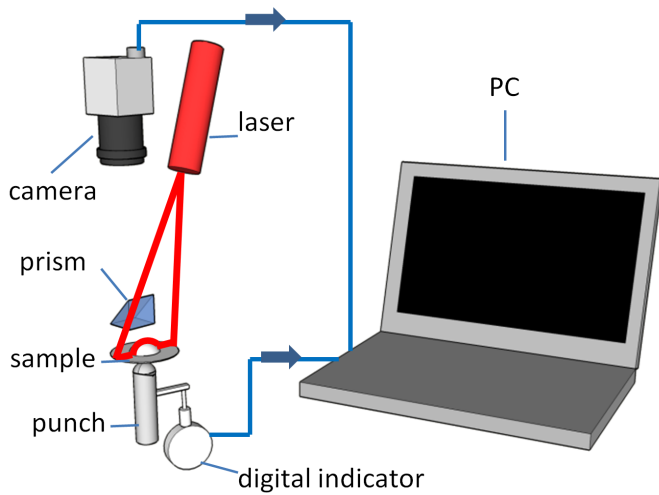

Fig. 10. Experimental setup

bigger changes in speckle images, and thus greater surface activity of the material associated with its displacement. For greater readability, the activity was presented on a logarithmic scale.

For all analyzed points, the activity increases sharply when the punch touches the material (punch displacement = 0 mm)

and at the moment of cracking (punch displacement around 13 mm). The graphs show also the characteristic moment when after the stabilization period the activity begins to decline until it reaches a very low level. This moment is shifted in time (specimen height) depending on the position of the measuring point relative to the central part of the specimen. This is related to the loss of stability, gradual disappearance of material deformations, beginning at the center of the sample and heading towards the future necking. In order to make the results independent from the measuring point position, the average value of activity determined along the measurement section is analyzed (Fig. 12). It allows determining the loss of stability (decrease in activity at the final stage of the process), as well as necking (activity stabilized at a low level) and fracture (rapid increase in activity).

In Fig. 13, an exemplary average activity graph with sample height measurement and image of speckle changes is summarized. This image is created by assembling a single line (1 px width) of the image taken along the laser line from the subsequent recorded frames. The next columns of this image are composed of pixels taken from the same place in successive frames. This allows to quickly tracking the activity of laser

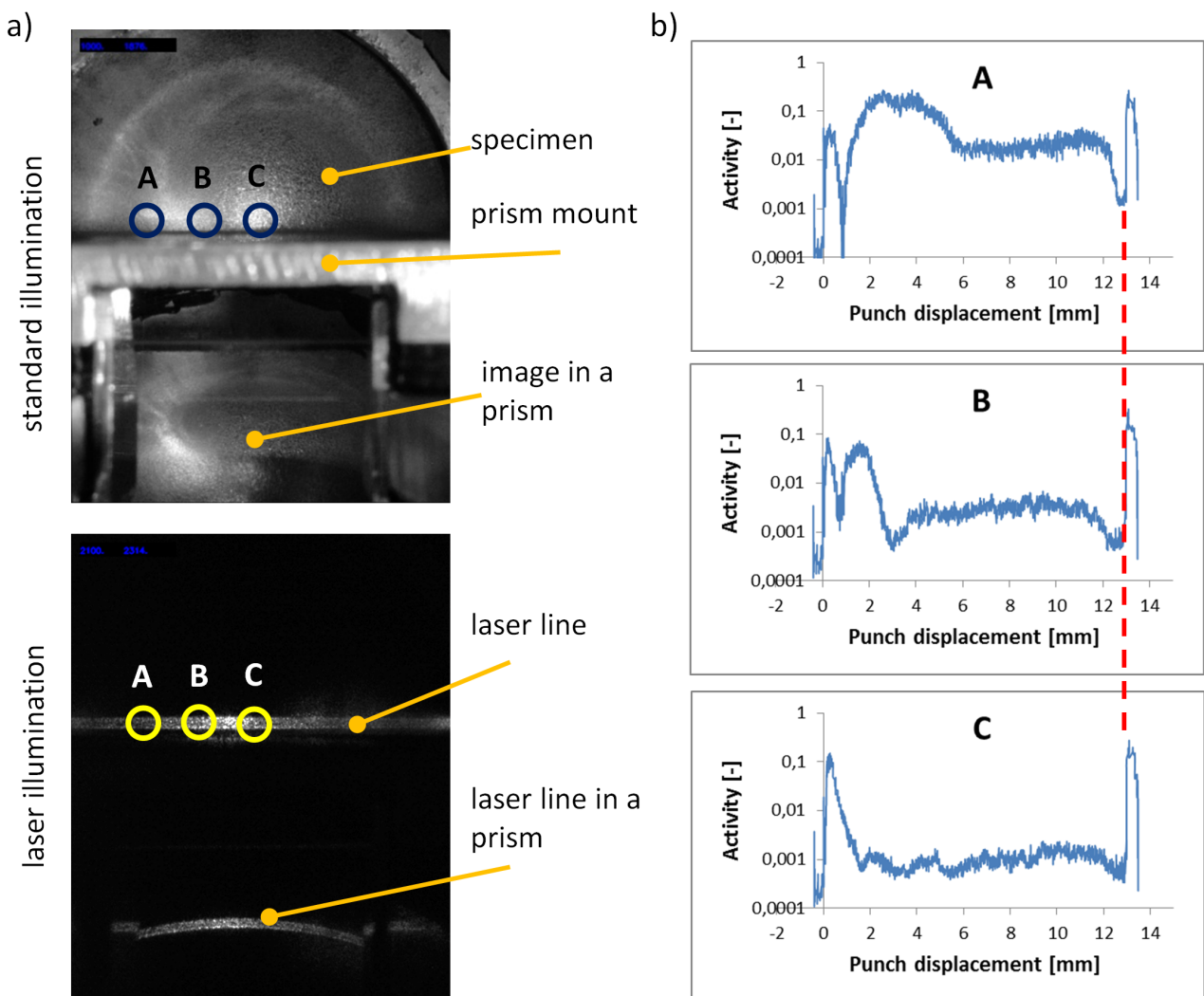

Fig. 11. Laser speckle activity registration: points of analysis (a) and activity graphs in a function of specimen height for selected points (b)

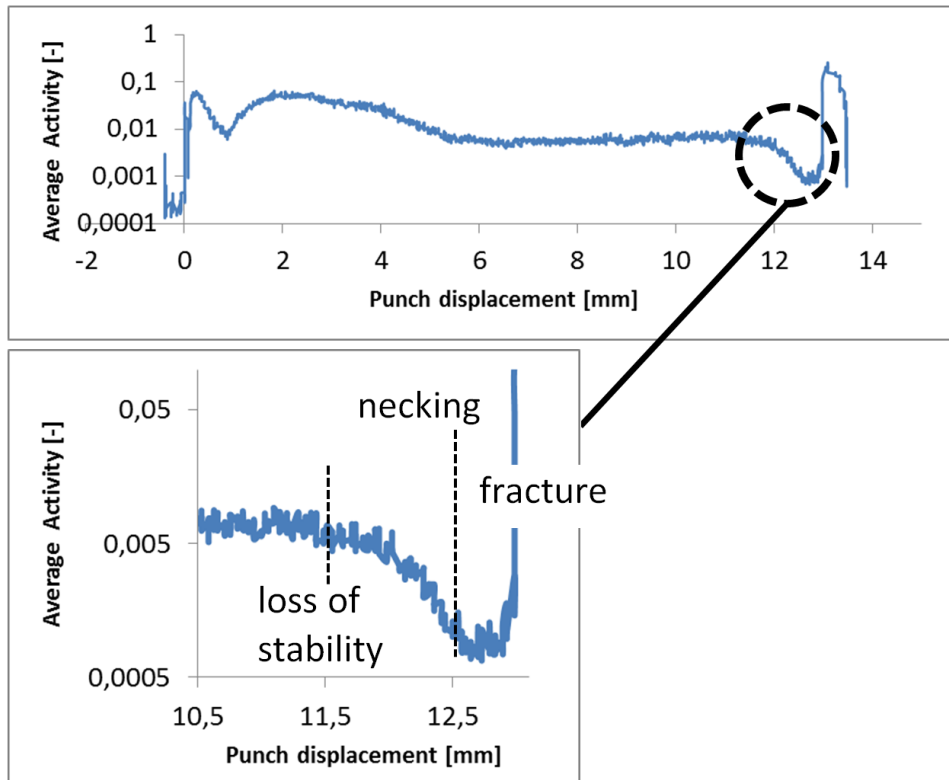

Fig. 12. Defect formation stages illustrated on the average activity graph

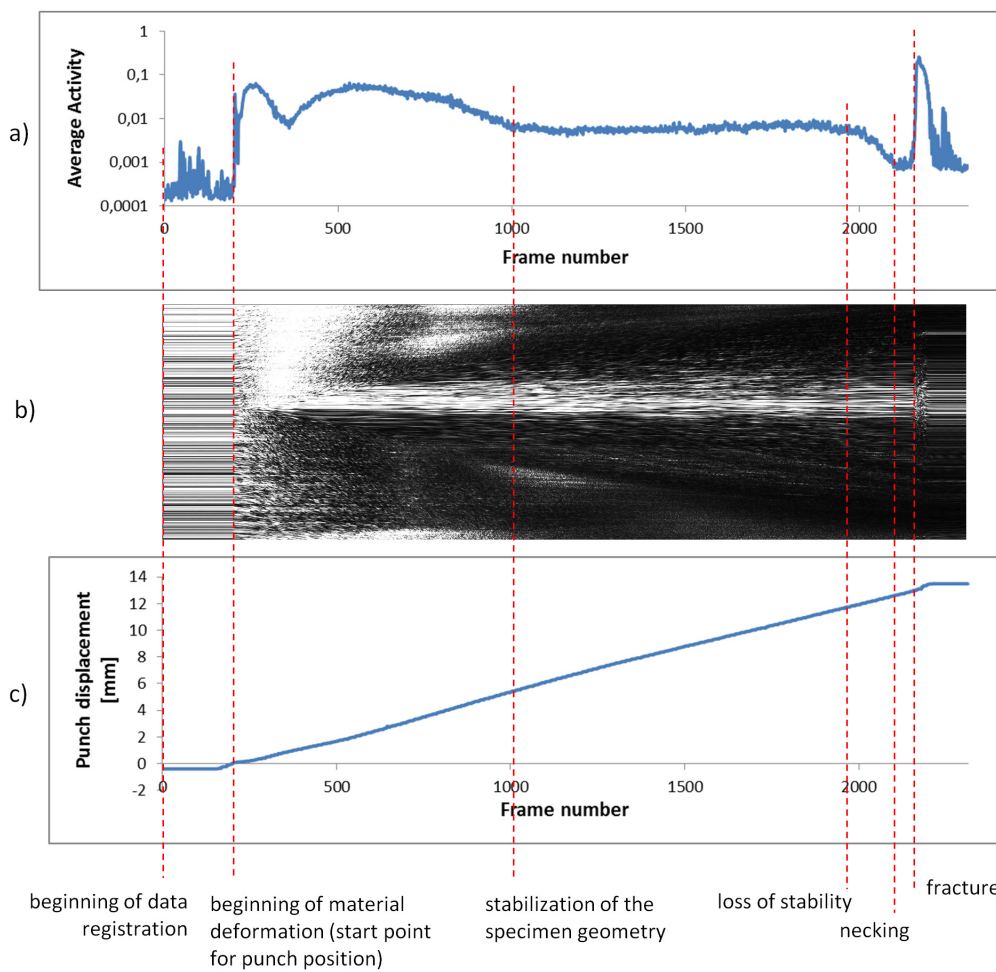

Fig. 13. Average activity graph a) with speckle changes image b) and punch displacement c) in the function of frame number

speckle for a selected row of pixels during the process [3]. On the basis of the average activity graph, it is also possible to locate the beginning of the process (the moment at which the punch reaches the specimen surface). This allows reading the start point of the punch position. Increased activity visible in the initial phase of the process (up to about frame no. 1000) is related to the stage in which the material adopts the punch geometry.

The entire deformation process was recorded by the camera and video recordings were subjected to later analysis. Table 2 presents the measurements results of the samples height for the loss of stability LS , necking N and fracture F for five specimens.

TABLE 2

Results obtained by the laser speckle analysis.

Sample no.	v1	v2	v3	v4	v8	Average
LS [mm]	11,70	11,50	11,60	11,60	11,30	11,54
N [mm]	12,40	12,50	12,45	12,55	12,30	12,44
F [mm]	12,90	13,00	12,70	12,90	12,65	12,83

3. Conclusions

- Both advanced methods of analysis of the Erichsen cupping test presented in this work, i.e. stochastic grid video analysis and laser speckle analysis, allow you to expand the range of information obtained during this test. This allows not only to determine the standard Erichsen number but also to follow the material deformation stages immediately preceding the occurrence of the crack. This is important because the course of the deformation process can vary considerably depending on the material being tested, even if the heights of the samples at the moment of cracking are the same.
- The method based on measurements of stochastic grid points displacements allows not only to obtain qualitative information about the course of the deformation process, but it can be easily extended to carry out quantitative measurements of deformations. It is a method especially dedicated to laboratory applications, where the preparation of specimen surfaces is not an obstacle. The measurement of displacements and deformations allows the development

of boundary criteria for both cracking and the occurrence of defects in the form of strain localization or necking.

- The method based on the laser speckle activity is more dedicated to industrial applications, as it does not require any additional treatments related to the preparation of the specimen surface. This method makes it possible to obtain qualitative information about the course of the deformation process in the Erichsen test with a precise distinction of the deformation stages and quick detection of discrepancies when comparing different grades of sheets or batches of sheet metals.

REFERENCES

- <https://www.erichsen.de/about-us/historical-significance>, 12.11.2018.
- 20482: Metallic materials – Sheet and strip – Erichsen cupping test, ISO, 2003.
- A. Kocańda, C. Jasiński, Arch. Civ. Mech. Eng. **16**, 211-216 (2016).
- Z. Gronostajski, Badania stosowane w zaawansowanych procesach kształtowania plastycznego, Oficyna Wydawnicza Politechniki Wrocławskiej (2003).
- K. Pramod, P.K. Rastogi, E. Hack, Optical Methods for Solid Mechanics: A Full-Field Approach, Wiley-VCH (2012).
- L. Farge, R. Nazarov, Z. Ayadi, Strain. **46** (3), 267-276 (2010).
- S. Świłło, Computer Methods in Materials Science **13** (2), 283-288 (2013).
- S. Świłło, P. Czyżewski, Prace Naukowe Politechniki Warszawskiej, Mechanika **253**, 33-38 (2013).
- J.L. Barron, D.J. Fleet, S.S. Beauchemin, International Journal of Computer Vision **12** (1), 43-77 (1994).
- A. Beghdadia, M. Mesbahb, J. Monteila, Image and Vision Computing **21** (4), 383-399 (2003).
- K.P. Horn, B.G. Schunck, Artif. Intell. **17**, 185-203 (1981).
- Z. Marciniak, Odkształcenia graniczne przy tłoczeniu blach. Wydawnictwa Naukowo-Techniczne, Warszawa (1971).
- C. Jasiński, A. Kocańda, Przegląd Mechaniczny **14** (9), 49-54 (2014).