



ARCHIVES of FOUNDRY ENGINEERING

 ISSN (2299-2944)
 Volume 2020
 Issue 2/2020

71 – 78

10.24425/afe.2020.131305

12/2



Published quarterly as the organ of the Foundry Commission of the Polish Academy of Sciences

Influence of the Process Treatment on the Amount and Grain Structure of After Reclamation Dusts

M. Skrzyński *

 AGH – University of Science and Technology, Faculty of Foundry Engineering
 Reymonta 23 Str., 30-059 Kraków, Poland

* Corresponding author. E-mail address: mskrzyns@agh.edu.pl

Received 10.10.2019; accepted in revised form 22.01.2020

Abstract

The analysis of after reclamation dusts generated during the reclamation treatment of test portions of two kinds of polydispersive material in the Regmas device, is presented in the hereby paper. For the comparative purpose the fresh moulding sand marked as quartz sand „Sibelco” –1K 0.40/0.32/0.20, J88, >14000C, WK = 1.20 (acc. PN-83/H-11077), as well as the spent moulding sand, which was previously subjected to the primary reclamation and to dedusting, were used. Conditions of the process treatment were forced by the frequency of supplying the vibratory drive motors being successively 40, 50 and 60Hz for 5, 10 and 15 min. and by causing a diversified material flow through the functional system of the device (charging hopper, abrasive chamber acting as a buffer space). Two states of the process treatment, when a material was flowing through the chamber, were applied. In the first one, an intergranular surface abrasion of grains occurred as a result of the granular material circulation in the chamber forced by the vibratory drive. In the second one, the forced material flow was performed in the presence of crushing elements (steel balls), additionally introduced into the abrasive chamber. Analyses of the device influence were performed by determinations of the amount of dusts separated in the pneumatic classifier and analysis of their grain sizes by means of Analysette 22NanoTec.

Keywords: Spent moulding sands, Regeneration of the quartz matrix, Vibratory reclamation, Environment protection

1. Introduction

Altogether 28818.0 thousand tonnes of wastes qualified as wastes from thermal processes, according to the binding in Poland regulation of the Minister of Environment Protection of December 29, 2014 concerning the wastes catalogue, were produced in 2016. To this group of wastes belong wastes from iron castings [group: 10 09] and non-ferrous metals castings [group: 10 10], which total production was equal 593.0 thousand tonnes.

Moulding and core sands belong to the most numerous group of wastes from foundry processes. The amount of these wastes

constituted, in the discussed year, nearly 80% of all produced wastes.

The reclamation process is presently the most efficient way of decreasing amounts of wastes from moulding and core sands. In dependence of the kind of the applied binder various reclamation systems are used. The mechanical [2-11] and thermal [11-18] reclamations are the most often applied for the matrices purification from spent binding materials.

The most recent investigations indicate also the possibility of applying the chemical reclamation in an aqueous environment [19]. Dusts formed during the dry mechanical reclamation process are separated from the purified matrix by means of the pneumatic

classification. Wrongly performed processing can cause not proper purification of grains, which can be the reason of a higher gas evolution rate from moulding sands prepared with the reclaim additions [20] as well as an increase of harmful substances from the BTEX and PAHs groups [21-23]. On the other hand, too intense reclamation process usually leads to an excessive matrix wearing, which is related not only to material losses but also to increased amounts of dusts.

2. Research aim

The research aim constitutes the analysis of the influence of the reclamation process intensity on the amounts and grain structure of after reclamation dusts, formed due to the destruction of spent binding material and also - partially - due to the quartz matrix wearing. The basic element of the analysis is the separation of individual dust fractions and pointing out their relation with the intensity of the applied reclamation method.

Two initial materials were used for comparisons. The first one was fresh quartz sand, marked - according to the standard PN-quartz sand „Sibelco” -1K 0.40/0.32/0.20, J88, >14000C, WK = 1.20 (acc. PN-83/H-11077), while the second one was spent moulding sand with furfuryl resin, originated from one of the domestic foundry plants. Spent sands obtained in a form of lumps were subjected to the primary reclamation and dedusting, in order to exhibit clearly - in the Regmas device - the effect of the secondary reclamation.

The tested initial materials were divided into 70 kg portions, which were subjected to process treatments satisfying conditions of the secondary reclamation (of a wide variability range of parameters) in the universal reclaimer Regmas (characterised in papers [24–27]). Grain size analysis of a matrix as well as tests of contents and granular structures of dusts were performed on samples taken from the lower part of Regmas, the so-called buffer chamber of the reclaimer (Fig. 1). These samples contained products of the secondary reclamation for the selectively realised processing conditions (time, frequency, a lack or presence of additional elements in the abrasive chamber).

Portions of tested granular materials i.e. dry quartz sand and spent moulding sand, were subjected to the same treatment. In both cases the analysis of the dust fraction of grain size within the range: 0-100 μm , were carried out. Compared were dusts structures obtained at the process treatment in the reclaimer without a presence of additional elements in the buffer chamber and structures obtained when together with sands the steel balls and rollers (of a total weight of 127.9 kg) were introduced into this chamber. The process treatment was carried out at a constant placement of unbalanced masses of rotodynamic motors corresponding to 42% of the maximum exciting force. The influence of the reclamation intensity on material portions was controlled by changes of the following parameters (at first for the fresh quartz sand and then for the spent moulding sand):

- frequency of motor supplying (electrovibrators) 40, 50 and 60 Hz., which correspond to the rotational speed: 82, 104 and 122 rad/s,
- time of duration of the reclamation treatment cycle of each material portion, being: 5, 10 and 15 minutes,
- performing process with additional abrasive elements and without them.

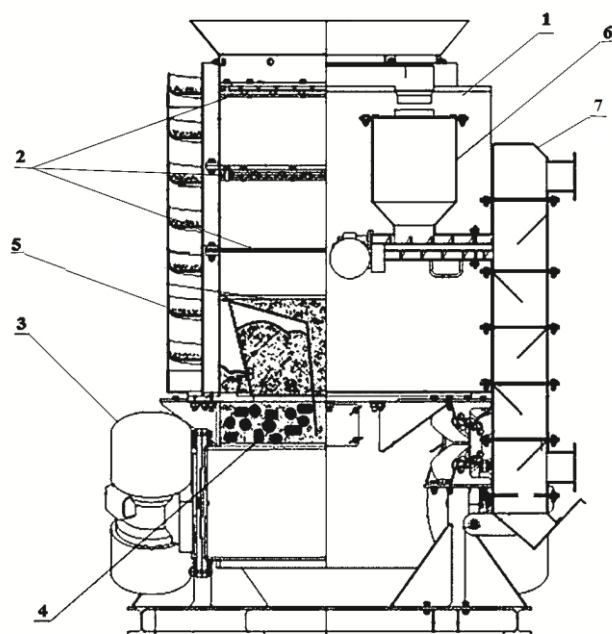

Fig. 1. Scheme of functional systems of the prototyped reclaimer Regmas; 1 - body, 2 - set of sieves, 3 - vibratory drive motor, 4 - abrasive chamber (buffer space), 5 - spiral transporting trough, 6 - container with feeding screw, 7 - cascade classifier [28]

The assumed time of 5 minutes corresponds to the average time of material treatment when the 70 kg portion is passing through the buffer chamber, at the reclaimer efficiency being 1000 kg/h. Times of 10 and 15 minutes are reflecting effects obtained respectively, when the assumed material portion (70 kg) was twice and thrice subjected to the treatment at the nominal efficiency of the device. For the research aims the operations character of the reclaimer was changed from the continuous mode into periodical mode. It was performed by limiting the moulding sand (or quartz sand) outflow from the buffer chamber to the spiral trough, for the determined treatment time.

The scheme of the comparative studies of the secondary reclamation of the spent moulding sand and the destruction of quartz matrix carried out on the research set-up Regmas is presented in Figure 2.

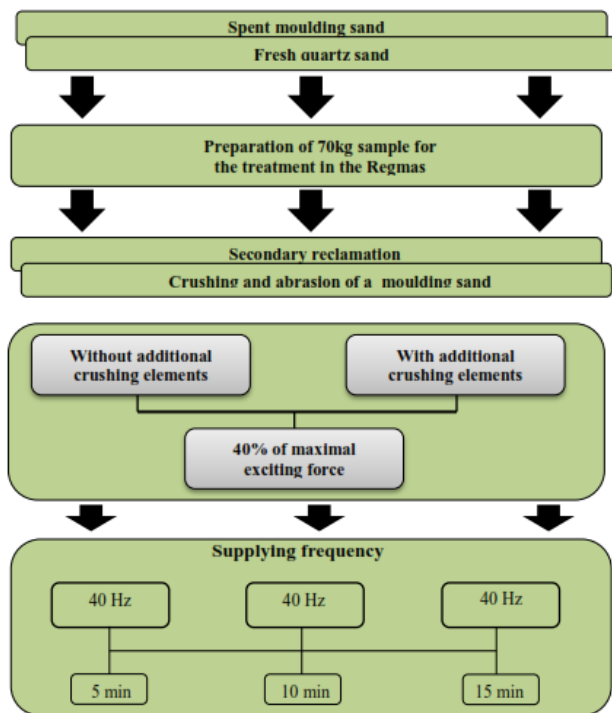

Fig. 2. The scheme of reclamation treatment of tested grain materials

3. Obtained results

The reclaim obtained from the spent moulding sand and the quartz matrix subjected to crushing-abrasive treatment were, first of all, assessed in respect of the amount of dusts formed in the performed reclamation treatment, after the determined operation time of the vibratory system. Notations of the treatment products obtained at the given operational parameters of the Regmas reclaimer are listed in Table 1. The dusts amount was determined by means of the laser analyser Analysette 22 NanoTec. Investigations were performed in aqueous environment, which allowed to take into account also dusts which grains were joined by electrostatic forces. 3 grain classes (fractions) were separated: 0-20, 20-50 and 50-100 micron.

3.1. Investigations of the quartz matrix destruction

On the basis of data presented in Figure 3 it can be noticed that the operation of the reclaimer under conditions of obtaining matrix O1 (Table 1), within its lower parameters range ($f_{sup} = 82$ rad/s (40Hz) and 42% of maximal exciting force, at a lack of abrasive elements), causes insignificant - in relation to the initial state - increase of dust fractions in the fresh moulding sand, after the treatment realised for the assumed time range: 0-15 min.

Table 1.

Notations of treatment products obtained at the given operational parameters of the Regmas reclaimer

Matrix	Operational parameters of the reclaimer Regmas				
	Additional crushing-abrasive elements	Setting of the exciting force	Supplying frequency of electro-vibrators	Reclamation time	Marking
	-	%	Hz	min.	
Spent sand	No	42	40-50-60	5-10-15	R1
	Yes	42	40-50-60	5-10-15	R2
Fresh sand	No	42	40-50-60	5-10-15	O1
	Yes	42	40-50-60	5-10-15	O2

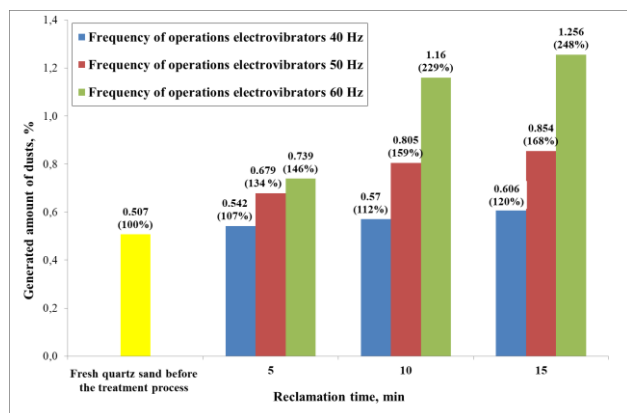

Fig. 3. Amount of dusts of 0÷100 µm fraction generated as a result of the fresh quartz sand treatment at the parameters marked as O1 in Table 1 [28]

Within this time range at the rotation frequency of 82 rad/s (40Hz) the dust fraction is increasing from 7% after 5 minutes to 20% after 15 minutes of the device operation.

Increasing the frequency f_{sup} , in turn, to 104 rad/s (50Hz) and 122 rad/s (60Hz) causes after 15 minutes of the treatment increases of dust fractions of 68.4% and 147.7% respectively, in relation to the initial state, while the participation of dusts in treated material equals maximum 1.256%.

The influence of the intensity of the reclamation treatment on the amount and grain structure of after reclamation dusts can be interpreted by the analysis of the dusts amounts taking into account their division into 3 grain fractions (classes): 0-20, 20-50 and 50-100 micron. Graphical illustration of the obtained data is presented in Figures 4 and 5.

The comparison of a percentage participation of dusts fractions: 0-20 micro, 20-50 micro and 50-100 micro in the reclamation product O1 after 15 minutes, is shown in Figure 4. For the described case, characterised by the treatment parameters mode marked O1 (Table 1), more intensive increase of fine

fractions - up to 50 μm - was found, while the increase of fraction 50-100 μm was insignificant. This represents a small degree of a destruction of quartz matrix grains in the whole frequency range and operation times of the reclaimers. It is also confirmed by measurement results of the grain shape indicator W_s presented in Table 2, which were determined after the treatment for all operational versions of the device in O1 mode.

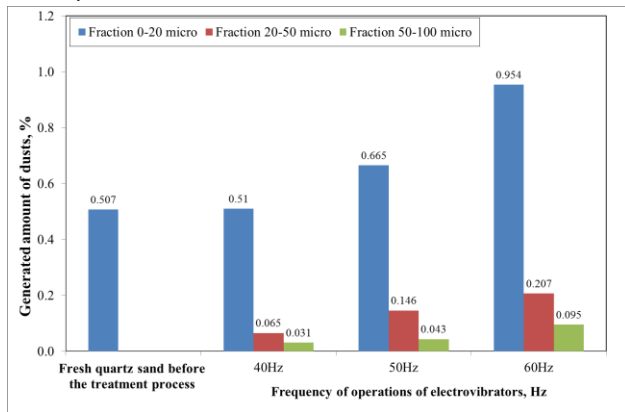

Fig. 4. Comparison of the percentage participation of dusts fractions: 0-20 μm , 20-50 μm and 50-100 μm in the fresh quartz sand after 15 minutes of treatment at the device parameters marked O1 in Table 1

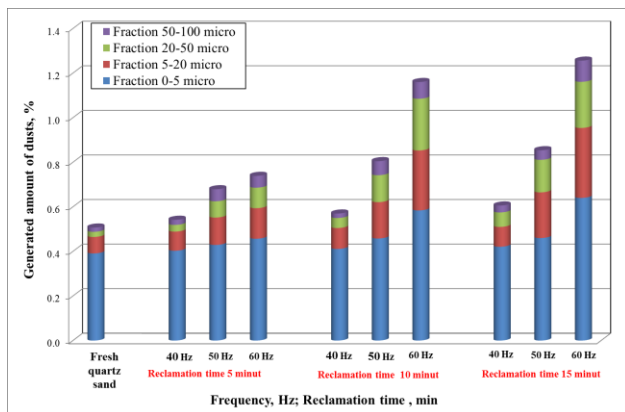

Fig. 5. Total amount of generated dusts with the marked participation of individual grain fractions for the treatment of the fresh quartz sand in O1 operation mode (Table 1) [28]

Table 2.

Results of determining the shape indicator W_s of the fresh quartz sand after the treatment performed in O1 mode [28]

f_{sup} , Hz	W_s indicator after the determined time of influencing		
	5 min	10 min	15 min
Fresh sand	1.20		
40	1.18	1.22	1.21
50	1.23	1.18	1.22
60	1.18	1.22	1.25

A significantly higher increase of fraction 0-100 μm is observed as a result of the reclaimers influence under conditions of obtaining matrix in the operation of O2 mode. In this mode, additional crushing-abrassive elements were placed in the buffer chamber of the device. Graphically presented results are shown in Figure 6.

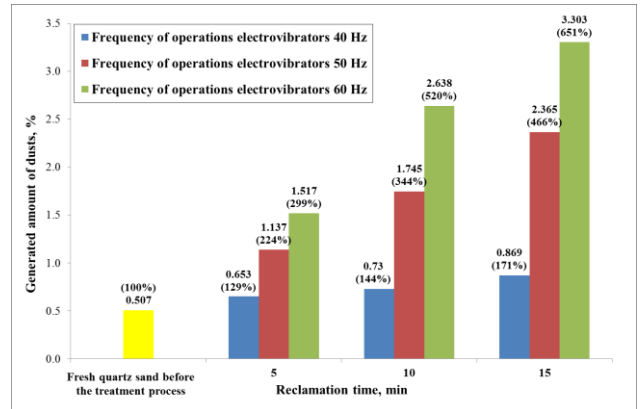

Fig. 6. Amount of dusts of 0-100 μm fraction generated as the treatment result of the fresh quartz sand at the device parameters marked O2 in Table 1 [28]

In this case, the most intensive treatment process of the fresh quartz sand is seen at operational frequencies of electrovibrators being 104 rad/s (50 Hz) and 122 rad/s (60Hz), for which after 15 minutes of the process a significant increase of this fraction can be seen, being 366.4% and 551.5% respectively (in relation to the initial value).

The application of additional crushing-abrassive elements significantly increases the contents of fraction 50-100 μm in dusts generated as a result of the device operation in O2 mode (Fig. 7). This is caused by crushing of matrix grains, revealed by the increase of indicator W_s value (Table 3), which was not observed when these elements were not added. A crushing effect is specially visible at the supply frequency of electrovibrators of 50 and 60 Hz.

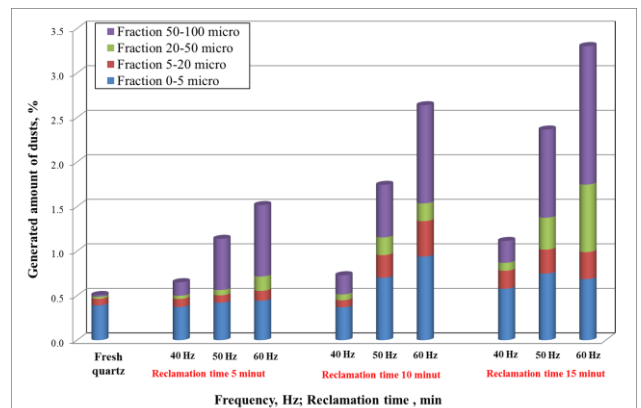

Fig. 7. Total content of dusts generated in the process treatment of the fresh quartz sand when the device was operated in O2 mode. The participation of individual grain fractions is shown (Table 1) [28]

The comparison of the percentage participation of dusts of fractions: 0-20 μm , 20-50 μm and 50-100 μm in the fresh quartz sand, after 15 minutes of the process treatment at the device parameters marked as O2 in Table 1, is presented in Figure 8.

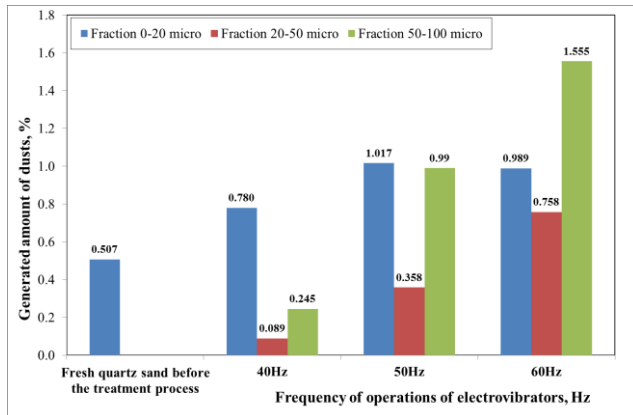

Fig. 8. Comparison of the percentage participation of dusts of fractions: 0-20 μm , 20-50 μm and 50-100 μm in the fresh quartz sand, after 15 minutes of the process treatment at the device parameters marked as O2 in Table 1

Table 3.

Determination of indicator W_s of the fresh quartz sand under conditions of obtaining the matrix in O2 mode [27]

f_{sup} , Hz	W_s indicator after the determined time of influencing	
	5 min	5 min
Fresh sand	1.20	
40	1.20	1.25
50	1.23	1.32
60	1.25	1.35

3.2. Investigations of dusts from the process treatment of the spent moulding sand

In case of spent moulding sands the increase of dusts amount is very significant. The marked in the Table 1 treatment R1 (frequency of rotovibrators: 40Hz (82 rad/s) - without additional crushing elements), causes the dust fraction increase from 96% after 5 minutes to 233% after 15 minutes. After the process treatment at the frequency of 60Hz (122 rad/s) the participation of dust fractions increases successively to 318% after 5 minutes, to 504% after 10 minutes and to 603% after 15 minutes, which is graphically presented in Figure 9.

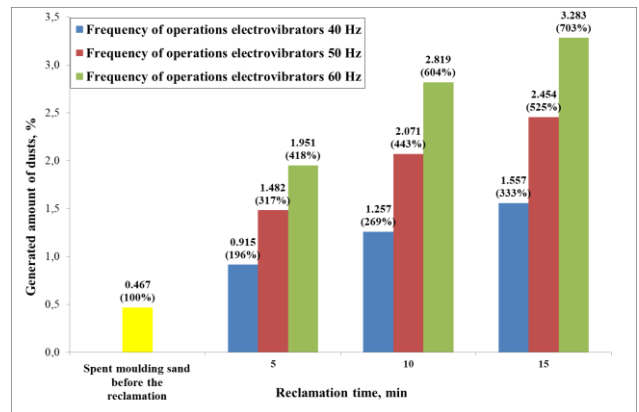

Fig. 9. Amounts of dusts of a fraction: 0-100 μm , generated as a result of the spent moulding sand secondary reclamation, at the device parameters marked in Table 1 for reclaim R1 [28]

Analogous investigations of the amount of dusts generated during the secondary reclamation of the spent moulding sand, at the device parameters marked in Table 1 as R2, are presented in Figure 10. The analysis of data indicates that for the supply frequency of rotovibrators being 60 Hz (122 rad/s) the increase of dust fractions - in the range: 0-100 μm - equals from 625% after 5 minutes of treatment to 1288% after 15 minutes, in relation to the initial value. Such significant increase of dust fractions under conditions corresponding to R2 mode, indicates the intensive abrasion of spent binder from surfaces of matrix grains as well as wearing of grains, which was indicated previously during the analysis of factors causing destruction of the fresh quartz matrix.

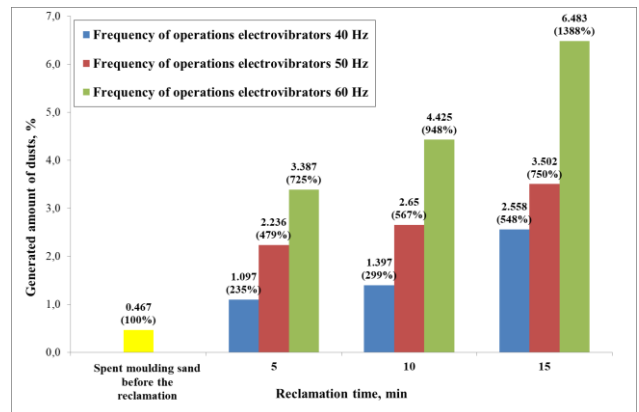

Fig. 10. Amounts of dusts of fraction 0-100 μm generated as a result of the secondary reclamation of spent sand, under condition of the reclaim obtaining R2 [28]

The comparative analysis of individual fractions increases for R1 and R2 modes indicates that the reclamation treatment under R1 conditions, i.e. without additional crushing elements, causes mainly increases of fine and middle fractions 0-50 μm (Fig. 11 and 12) in the after reclamation dusts. In turn, a significant increase of the intensity of the device influence on the material subjected to treatment, e.g. corresponding to R2 condition, increases the amount of the finest 0-20 μm and the coarse fraction 50-100 μm (Fig. 13 and 14).

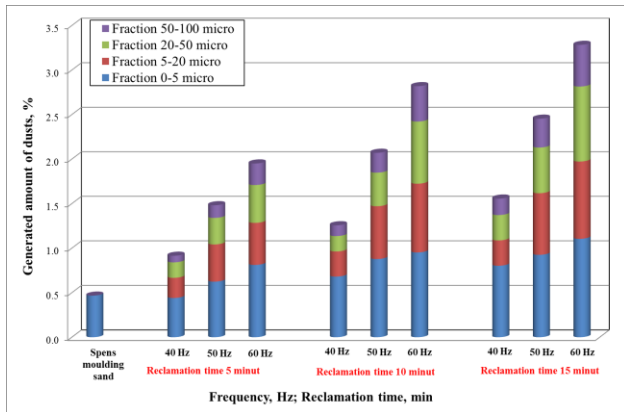

Fig. 11. Total content of generated dusts, with marking of individual grain fractions, after the secondary reclamation of the spent moulding sands, under conditions R1 [28]

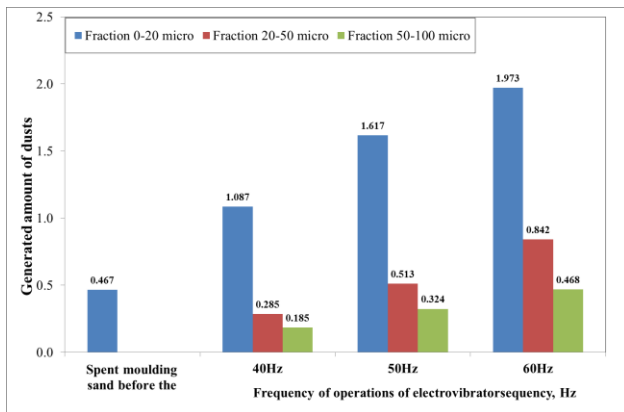

Fig. 12. Comparison of percentage participation of dusts fractions 0-20 μm , 20-50 μm and 50-100 μm after 15 min. of the secondary reclamation at the device parameters marked as R1

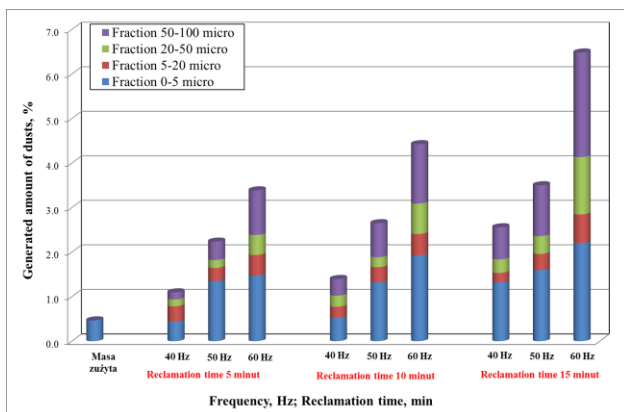

Fig. 13. Total content of generated dusts, with marking of individual grain fractions, after the secondary reclamation of the spent moulding sands, under conditions R2 [28]

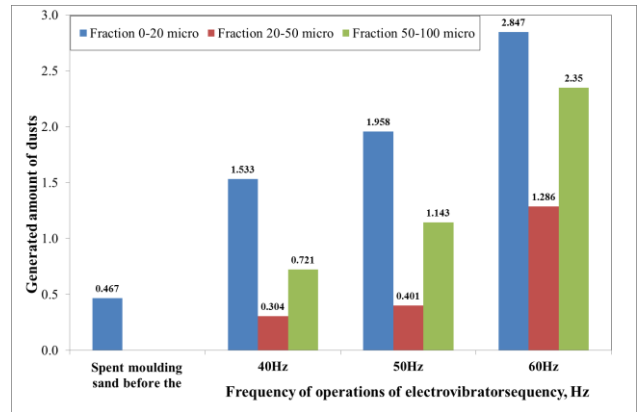

Fig. 14. Comparison of percentage participation of dusts fractions 0-20 μm , 20-50 μm and 50-100 μm after 15 min. of the secondary reclamation at the device parameters marked as R2

4. Summary

The performed investigations allow to assess the process treatment influence on the amount and grain structure of after reclamation dusts.

When analysing the amounts of dusts generated during the treatment in the reclaiming Regmas, at the operation parameters marked as O1 and O2, of the pure quartz sand - considered the reference material - a significant increase of dusts (up to 551.5%) in relation to the amount in initial state, was found.

When the spent moulding sand was subjected to the reclamation treatment R2 nearly twice as much of dusts were generated than in case of the treatment marked as O2, which was mainly the effect of abrasion of the spent binding material.

The analysis of the obtained dust fractions allows to state that, regardless of the material subjected to the treatment, the reclamation process performed without additional crushing elements causes - in a higher degree - a formation of fine and medium fractions of dimensions 0-20 micro and 20-50 micro. Whereas the application of additional crushing elements causes mainly increases of the coarse fraction 50-100 micro and the finest fraction 0-20 micro.

The assumed times of the reclamation treatment of the determined material portion represent effects obtained in the typical continuous operation of the device (5 min.) as well as in the prolonged reclamation time, which corresponds to the dual (10 min.) or triple (15 min.) number of reclamation cycles of the tested polydisperse material.

5. Conclusions

1. In attempting to improve the mechanical reclamation effect, aimed at the matrix purification from coatings of the spent binding material, it should be taken into account that the technological durability of moulding sands on a quartz matrix is determined - first of all - by the durability of this matrix, which during the multicyclic treatment is gradually wearing.

2. At changes of the treatment intensity, which were realised in comparative investigations of two polydispersive materials, changes from O1 to O2 mode and from R1 to R2 mode, a significant increase of dust fractions occurs in the frequency range of supplying vibratory drive (50-60 Hz) and treatment time and the application of additional crushing elements.
3. The structure of generated dusts obtained at the reclamation treatment of an increased intensity, proves that the crushing operation is dominating in the general matrix degradation. This is specially visible at the treatment of dry quartz sand. Options of intensive reclamation treatments can be applied for moulding sands difficult for the reclamation.

References

- [1] Act of 29 December 2014 on the waste catalog. (2014). Journal of Laws of the Republic of Poland. Retrieved May 30, 2019, from <http://prawo.sejm.gov.pl/isap.nsf/download.xsp/WDU20140001923/O/D20141923.pdf>. (in Polish).
- [2] Pezarski, F., Maniowski, Z. & Izdebska-Szanda, I. (2004). Practical aspects of the sand regeneration process from used molding and core sands. *Archives of Foundry*. 4(13), 171-176. (in Polish).
- [3] Holtzer, M., Danko, R. & Żymankowska-Kumon, S. (2012). Foundry industry - current state and future development. *Metalurgija*. 51(3), 337-340.
- [4] Danko, R. (2013). Criteria for an advanced assessment of quality of moulding sands with organic binders and reclamation process products. *China Foundry*. 10(3).
- [5] Joseph, M.K., Banganayi, F. & Oyombo, D. (2017). Moulding Sand Recycling and Reuse in Small Foundries. *Procedia Manufacturing*. 7, 86-91. DOI:10.1016/J.PROMFG.2016.12.022.
- [6] Danko, R., Holtzer, M. & Danko, J. (2014). Investigations of physicochemical properties of dusts generated in mechanical reclamation process of spent moulding sands with alkaline resins. *China Foundry*. 11(2), 132-138.
- [7] Li, Y., Wang, T. & Liu, W. (2018). Research on regeneration methods of animal glue waste sand for foundry. *Royal Society Open Science*. 5(5).
- [8] Khan, M.M., Singh, M., Mahajani, S.M., Jadhav, G.N. & Mandre, S. (2018). Reclamation of used green sand in small scale foundries. *Journal of Materials Processing Technology*. 255, 559-569. DOI:10.1016/j.jmatprotec.2018.01.005.
- [9] Kamińska, J., Basińska, E., Angrecki, M., & Palma, A. (2018). Effect of mechanical reclamation cycle on strength parameters of loose self-hardening sands based on furfuryl resin. *Archives of Metallurgy and Materials*. 63(4), 1843-1846. doi:10.24425/amm.2018.125113.
- [10] Szlumczyk, H., Janerka, K. & Szajnar, J. (2008). Analysis of the processes in pneumatic moulding sand reclamation. *Archives of Foundry Engineering*. 8(2), 137-140.
- [11] Szlumczyk, H. (2005). Analysis of two-phase stream motion in a linear regenerator. *Archives of Foundries*. 5(15), 387-396.
- [12] Łucarz, M. (2014). Thermal reclamation of the used moulding sands. *Metalurgija*. 54(1), 109-112.
- [13] Sappinen, T., Orkas, J. & Kronqvist, T. (2018). Thermal Reclamation of Foundry Sands Using Repurposed Sand Dryer Equipment. *Archives of Foundry Engineering*. 18(4), 99-102.
- [14] Kaczmarek, K., Grabowska, B. & Łucarz, M. (2014). Thermal Reclamation Process of the Spent Moulding Sand with the Polymer BioCo2 Binder. *Archives of Foundry Engineering*. 14, (spec.3) 90-94.
- [15] Łucarz, M. (2015). Setting temperature for thermal reclamation of used moulding sands on the basis of thermal analysis. *Metalurgija*. 54(2), 319-322.
- [16] Łucarz, M. (2015). Ecological aspects of the performed thermal reclamation. *Archives of Metallurgy and Materials*. 60(1), 329-333. doi:10.1515/amm-2015-0054.
- [17] Łucarz, M. (2018). Method of selecting the reclamation temperature of spent moulding sands with organic binders. *Archives of Foundry Engineering*. 18(1), 65-70. DOI:10.24425/118813.
- [18] Dereń, M., Łucarz, M., Rocznik, A. & Kmita, A. (2017). Influence of Reclamation Process on the Ecological Quality of Reclaim Sand. *Archives of Foundry Engineering*. 17(4), 43-46. DOI:10.1515/afe-2017-0128.
- [19] Balbay, S. (2019). Recycling of waste foundry sands by chemical washing method. *China Foundry*. 16(2), 141-146.
- [20] Dańko, R., Holtzer, M., Kmita, A., Żymankowska-Kumon, S., Kubecki, M., Skrzyński, M. (2015). *Influence of the regenerate addition on the quality of castings and harmfulness of new generation molding and core sands*. Kraków: Wydawnictwo Naukowe AKAPIT. (in Polish).
- [21] Ribeiro, M.G. & Filho, W.R.P. (2006). Risk assessment of chemicals in foundries: The International Chemical Toolkit pilot-project. *Journal of Hazardous Materials*. 136(3), 432-437. DOI:10.1016/J.JHAZMAT.2006.01.019.
- [22] Holtzer, M., Bobrowski, A., Dańko, R., Żymankowska-Kumon, S. & Kolczyk, J. (2013). Influence of a Liquid Metal Temperature on a Thermal Decomposition of a Phenolic Resin. *Archives of Foundry Engineering*. 13(2), 35-38. DOI:10.2478/afe-2013-0032.
- [23] Pytel, Z. (2012). Characteristic of ceramic materials obtained with used moulding sands containing organic binders Abstract. *Archives of Foundry Engineering*. 12(spec.1), 153-162.
- [24] Dańko, J., Kamińska, J. & Skrzyński, M. (2013). Reclamation of spent moulding sands with inorganic binders in the vibratory reclaiming REGMAS. *Archives of Metallurgy and Materials*. 58(3), 993-996. DOI:10.2478/amm-2013-0117.
- [25] Dańko, J., Dańko, R. & Skrzyński, M. (2015). Used furan sand reclamation in REGMAS vibratory unit. *Archives of Foundry Engineering*. 15(3), 25-28.
- [26] Skrzyński, M. & Dańko, R. (2016). Influence of the Reclamation Process Intensity in the REGMAS Reclaimer on the Purification Degree of the High-silica Matrix. *Archives of Foundry Engineering*. 16(1), 69-72.
- [27] Kowal, J., Dańko, J. & Stojek, J. (2013). Quantitative and qualitative methods for evaluation of measurement signals on the example of vibration signals analysis from the corps of

prototype reclaimer REGMAS. *Archives of Metallurgy and Materials*. 58(3), 827-831. DOI:10.2478/amm-2013-0080.
[28] Skrzyński, M. (2017). *Analysis of the initial phase and the actual working cycle of the REGMAS universal vibrating*

regenerator. Kraków: Akademia Górniczo-Hutnicza im. Stanisława Staszica w Krakowie. (in Polish).