







Combined treatment technology for storm runoff and circulating waters from vehicle transport enterprises

Oleksandr Kvartenko¹⁾ , Andriy Lysytsya²⁾  , Nataliya Kovalchuk¹⁾ ,
Ihor Prysiazhniuk²⁾ , Oksana Pletuk¹⁾ 

¹⁾ National University of Water and Environmental Engineering, Educational and scientific institute of construction and architecture, Rivne 11 Soborna St., 33028, Ukraine

²⁾ Rivne State University of Humanities, Faculty of Natural Sciences and Psychology, Plastova St, 31, Rivne, 33000, Ukraine

RECEIVED 08.07.2020

REVIEWED 17.09.2020

ACCEPTED 17.11.2020

Abstract: The development of transport infrastructure strengthens the technogenic burden on the environment. Waste, thaw and rain waters from vehicle transport enterprises, such as car-washing installations, petrol stations, and car service stations may pollute ground and surface waters, and adjacent landscapes. The article presents quality parameters and suggests a number of measures permitting to minimize the harmful impact on the environment. The purpose is to improve the reagent treatment technology applicable to surface runoff from vehicle transport enterprises and the reuse of circulating waters by improving well-known methods with original technological procedures and chemical reagents. Research methods include the use of potentiometry, titrimetry, and gravimetry. The investigation has shown the possibility to increase the efficiency of runoff treatment and removal of suspended particles and dissolved organic matter by 20–30%. This can be achieved by the application of a permanent magnetic field of 30–40 mT and the subsequent processing by the solution of aluminum chlorohydrate. Optimum parameters have been determined regarding magnetic field and processing conditions. It has been proven that the use of aluminum chlorohydrate in combination with polyhexamethyleneguanidine hydrochloride simplifies substantially the technological cycle. A better treatment can be achieved in comparison with the usual coagulant by 25%. Heavy metal ions are removed from water and the method includes microbiological disinfection and preservation of water in storage reservoirs. The improved technological scheme suggests the reagent treatment of storm and circulating waters for their repeated use.

Keywords: circulating waters, combined reagents, magnetic field, vehicle transport enterprises

INTRODUCTION

Due to the climate change and increasing deficit of clean water, the question of economic use of water has become urgent. The same applies to the introduction of technologies facilitating repeated inclusion of circulating waters into technological processes. One of pollution sources is the transport infrastructure [SETO *et al.* 2012], which also consists of vehicle service stations, petrol stations, garages, technical service stations and car-washing installations. The said facilities are located mainly far from urban sewage networks and discharge non-treated storm runoffs and washing

waters into their surroundings and surface reservoirs. Such facilities situated within town boundaries also have negative impact on the environment by discharging non-treated storm runoff. Pollutants include mainly solid particles, salts of heavy metals, different organic matter, oil products, products of fuel incomplete combustion, and car tires abrasion [BARBOSA *et al.* 2012]. According to CHAYKA [2019] the concentration of suspended particles (SP) and oil products (OP) in wastewater from vehicle transport enterprises (VTE) depends on the category of cars (Tab. 1).

Besides SP and OP, wastewater after washing cars may also contain acids, alkali, synthetic surface active substances, and

Table 1. Concentration of suspended particles and oil products in waste waters of vehicle transport enterprises (VTE) depending on car category

Type of run-off	Pollution concentration (mg·dm ⁻³)	
	suspended particles	oil products
Washing of passenger cars	400–600	20–40
Washing of trucks	2000–4000	50–250
Rainfall from car washes	2000	30–70

Source: own elaboration based on: CHAYKA [2019].

heavy metals [BARBOSA *et al.* 2012]. In the dispersion content OP in wastewater from VTE may be in free, emulsified or dissolved states. In thaw and rainwater from petrol stations, the content of salts may exceed admissible concentrations by 8–117 times; the content of OP may exceed admissible norms by 8.4–21.6 times [SADILLO 2007].

Therefore, to protect surface and ground waters and natural landscapes from pollutions storm and wastewater from transport infrastructure, it is necessary to foresee a number of measures:

- create circulating systems of water supply using treated rain and thaw runoff from transport enterprises and the reuse of water after car washing;
- develop and introduce efficient treatment and disinfection technologies for storm and circulating waters; and
- control the content of discharged runoffs.

To treat rainwater runoffs and circulating waters from washing cars, at present we use mechanical, physical-chemical, chemical methods. Mechanical methods of practical importance include gravitational sedimentation, centrifuging, and filtration. Physical-chemical methods include flotation, coagulation, and sorption, whereas chemical methods chlorination and ozonation.

SADILLO [2007] substantiates the dynamics of sorption and oxidation of pollutions in wastewater from petrol stations and car-washing installations with the formation of galvanic couple from carbon containing waste and transient metals (Fe and Al). The technology is suggested of treating wastewater using cheap filtering loadings from carbon containing wastes of electrode plants.

According to BIKUNOVA [2000], the possibility is substantiated with treating wastewater from car washing installations by way of the non-reagent coagulation method. The method includes the treatment of wastewater by mixing it with air and active chlorine in the electric field with the subsequent filtration through granular loading.

In their work, EPOYAN *et al.* [2014b] presented results of research on treating oil containing wastewater while using filters with foam polyurethane loading. Their high efficiency is determined for providing the necessary quality of treating surface water on territories of towns and industrial enterprises. The technology and the installation are suitable for non-reagent treatment.

The analysis shows that traditional technological schemes for treating circulating and storm water from car-washing installations are based mainly on the coagulation method, since about 90% of all pollutions are in the form of suspended and

colloidal particles. Coagulation is usually provided by aluminum chlorohydrate (Al_n(OH)_(3n-m)Cl_m) or ferric chloride (FeCl₃), and disinfection of water and sediments sodium hypochlorite (NaClO). All these measures lead to an increased content of salts and to corrosive activity of circulating water.

Moreover, coagulation is strengthened in reagent technological schemes by the frequent use of flocculants, for example, polyacrylamide [GETMANTSEV *et al.* 2008; LEE *et al.* 2011]. However, recently water treatment technologies increasingly often use a variety of combined reagents. A single composite may include, for example, coagulant, flocculent, precipitant, and adsorbent. The application of composites simplifies the operation of local treatment facilities and reduces power costs. Thus, in our opinion, treatment technologies applicable to storm and circulating waters from VTEs should use combined reagents based on aluminum chlorohydrate and polyhexamethyleneguanidine hydrochloride (PHMGH).

The aim of studies on the improvement of the reagent treatment technology for surface runoff from vehicle transport enterprises and circulating waters from car-washing installations provide for the reuse of water and its combined application as well as improved methods and reagents permitting simultaneously decrease pollutant concentration, corrosive activity and the content of salts in circulating waters and prevent bacterial pollution and bio-growth at the technological equipment. To achieve the set objective the following tasks need to be implemented:

- reveal the possibility of increasing the efficiency of treatment as a result of preliminary exposure to the constant magnetic field (CMF) of 30–40 mT and subsequent processing by the solution of aluminum chlorohydrate;
- carry out comparative studies on different technological schemes for treating circulating waters;
- study the possibility of using combined reagents containing aluminum chlorohydrate to stimulate coagulation and 1% polyhexamethyleneguanidine hydrochloride (PHMGH) to promote flocculation and disinfection;
- test the possibility of removing heavy metal ions from water with the help of combined reagents;
- improve the technology for joint treatment of storm and circulating waters.

MATERIALS AND METHODS

To determine pH we used pH-meter 3B-74; the concentration of suspended substances and oil products was determined by the gravimetric method, laboratory balance WLP-200, and the titrimetric method was used to determine permanganate oxidizability. Power characteristics of magnetic fields (Tab. 2) were measured with the help of universal teslameter 43205. The research also involved magnet blocks of 50 × 80 mm and ozonizer GL-3188.

Specially prepared emulsion was used to model waste and circulating waters from car-washing installations (Tab. 3). Water studied contained high concentration of a solid phase, dissolved and emulsified oil products, and non-soluble oils.

We used aluminum chlorohydrate (Al_n(OH)_(3n-m)Cl_m) as a coagulant and water-soluble polymer polyhexamethyleneguanidine hydrochloride as a flocculent and a reagent for the

Table 2. Changes of magnetic field induction (*B*) and distance between magnet blocks

Parameter	Value					
Distance between blocks of magnets (cm)	10	9	8	6	5	3
Magnetic field induction (mT)	6.1	7.6	9.7	17.3	32.3	56.5

Source: own elaboration.

Table 3. Characteristics of model solutions

Quality index	Quantity
Suspended particles (SP) (mg·dm ⁻³)	1400–1800
Permanganate oxidizability (PO) (mg O·dm ⁻³)	200–300
Oil products (OP) (mg·dm ⁻³)	255–346

Source: own elaboration.

disinfection/decontamination, since these were relatively safer for higher organisms and ecosystems [LYSYTSYA *et al.* 2015]. This was a high molecular cationic polyelectrolyte (molecular weight: 700–10 000 amu), CAS number: 57029-18-2. The construction of a monomer is presented below:

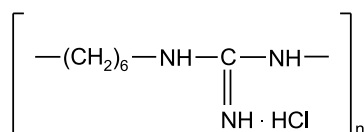

The most important peculiarity of the PHMGH is the presence of biocide properties [LYSYTSYA *et al.* 2015; MITCHENKO *et al.* 2010], as well as complex forming and flocculent properties. According to YANUSHEVSKA [2019], the PHMGH has been recommended as an efficient cationic flocculent. This enabled to decrease the dosage of the coagulant by 2–4 times [NYZHNYK *et al.* 2009].

According to ZHURBA and KVARTENKO [2009], higher induction of 30–40 mT or higher magnetic field stimulated the inhibition of developing microorganisms in the aquatic environment. Therefore, in order to intensify the process of separating phases and inhibition of microorganisms formation in waste water, we exposed it to the constant magnetic field of 30–40 mT.

The first stage of the study was carried out under static conditions. The effect was determined from the impact of the constant magnetic field (CMF) on the treating of the modular solution from suspended and dissolved organic matter with the subsequent introduction of coagulant solution. We poured the modular solution into two vessels of 100 cm³. One of them was under the impact of CMF power lines created by the block of constant magnets located at the distance of 0.05 m. The second sample was not exposed to CMF. The duration of the magnetic field action of 32.3 mT per the coagulant solution was 4 min. After that, the solution of the coagulant of aluminum hydroxide chloride of 100 mg·dm⁻³ was added to the modular solution. The content was mixed for 2–3 min with the help of a magnetic mixer and settled for 20 min. After flocculation and division into phases

started, samples were taken. In the clarified water, we determined pH, the concentration of suspended substances, the permanganate oxidizability, and the content of oil products.

At the second stage, we used the original pilot installation (Fig. 1).

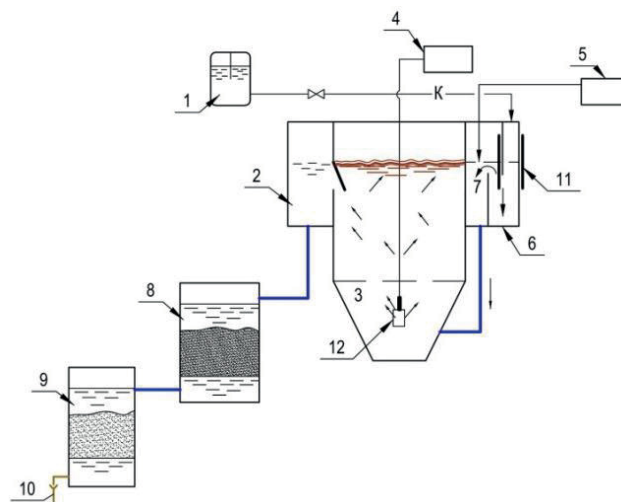

Fig. 1. Scheme of pilot installation: 1 = tank of initial water; 2 = collection pocket; 3 = floatator; 4 = compressor; 5 = metering tank; 6 = chamber of magnetic activation; 7 = mixing chamber; 8 = clarifying filter with sand filling; 9 = sorption filter; 10 = treated water tap; 11 = block of constant magnets; 12 = fine bubble aeration device; K = water supply; source: own elaboration

During the third stage, we studied the possibility of using the composite as a component of aluminum chlorohydrate and the PHMGH to increase the treatment efficiency in the case of storm and circulating waters containing emulsified oils and oil products. The study was conducted under static conditions using basic technological schemes (Tab. 4). Reagents (aluminum chlorohydrate, PHMGH, ozone, activated carbon powder) were used in various combinations and doses. The processing of circulating waters was carried out in cylinders of 500 cm³ in volume. The contact time of treated water with the PHMGH was 10–20 min, and with ozone 5 min. The filtration was carried out in 20 mm diameter column, with load of 350 mm from quartz sand, and with fractions granularity of 0.8–2.0 mm.

RESULTS AND DISCUSSIONS

The study helped determine the treatment of runoffs under static conditions and the increase in efficiency of removing SP and the decrease of permanganate oxidizability (PO) in solutions under the impact of the constant magnetic field (CMF). Thus, for example, under usual conditions the decrease in SP was observed from 1400 mg·dm⁻³ to 15–20 mg·dm⁻³, and PO from 200 mg O·dm⁻³ to 23.2 mg O·dm⁻³. In the case of filtration of runoffs undergoing the processing by the CMF, parameters of pollutions were correspondingly 7.4 mg·dm⁻³ and 16 mg O·dm⁻³.

The dependence of the efficiency of treatment on the settling duration (Fig. 2) showed that while processing of the modular solution in a magnetic field with the subsequent introduction of a coagulant solution, a distinctive acceleration of coagulation and sedimentation was observed.

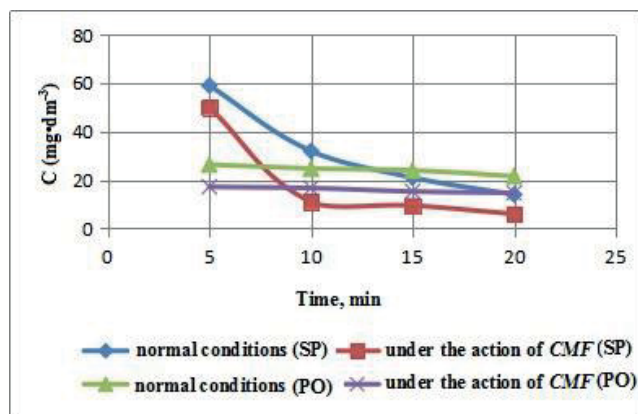

Fig. 2. Impact of changing the content of suspended particles (SP) and permanganate oxidizability (PO) on the duration of settling under usual conditions and under the impact of a constant magnetic field (CMF); initial contents of $C_{SP} = 1800 \text{ mg}\cdot\text{dm}^{-3}$ and $C_{PO} = 200 \text{ mg O}\cdot\text{dm}^{-3}$; source: own results

The study of the impact of the duration of exposure and distance between magnet blocks on the efficiency of dissolved organic matter treatment (Tab. 3) showed that the larger the distance between magnets and lower induction value of the magnetic field (Tab. 2), the worse the efficiency of treatment (Fig. 3). Theoretical bases of these processes were considered earlier [KVARTENKO, ZHURBA 2010].

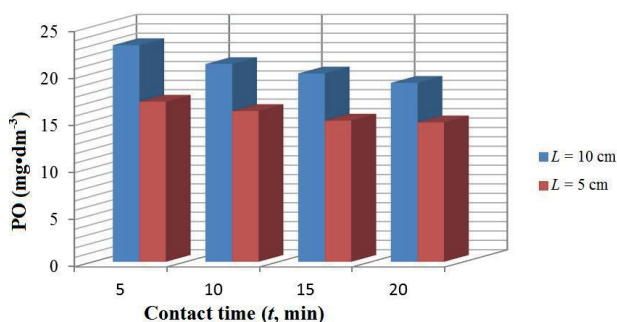

Fig. 3. Change of permanganate oxidizability (PO) content depending on contact time (t) and distance (L) between magnet blocks; source: own study

At the next stage, the research was conducted at the pilot installation (Fig. 2). The initial concentration of dissolved organic substances in PO value was $280\text{--}300 \text{ mg O}\cdot\text{dm}^{-3}$. The concentration of aluminum chlorohydrate was $70 \text{ mg}\cdot\text{dm}^{-3}$. PO and SP after the flotator were on the average level, $37.2 \text{ mg O}\cdot\text{dm}^{-3}$ and $54.3 \text{ mg O}\cdot\text{dm}^{-3}$, respectively. After passing the sand filter, the PO and SP values were within the range of $18.8\text{--}19.5 \text{ mg O}\cdot\text{dm}^{-3}$ and $4.0\text{--}2.5 \text{ mg}\cdot\text{dm}^{-3}$. Behind the sorption filter, the PO value was $7.0\text{--}8.2 \text{ mg O}\cdot\text{dm}^{-3}$. No suspended particles were found behind the filter with activated carbon powder.

Comparative studies were also carried out on removing oil products from waste waters using technological schemes: a) coagulation – flotation – filtration; b) treating water in magnetic field with subsequent coagulation – flotation – filtration. In scheme a), the content of oil products decreased from $346 \text{ mg}\cdot\text{dm}^{-3}$ to $11.5 \text{ mg}\cdot\text{dm}^{-3}$. In scheme b), oil products in filtrate were not found. The filtration rate on the sand filter was on average $5 \text{ m}\cdot\text{h}^{-1}$.

The increased efficiency of water treatment as a result of its preliminary exposure to the magnetic field with the subsequent coagulation-flotation-filtration, as compared with the known technological schemes may be explained by large metastable complexes developed in treated water. It stimulates adsorption and coagulation.

It is known that the treatment of aqueous solutions with the external magnetic field stimulates a number of processes leading to the change of their structure, the extent of hydration and the trajectory of hydrated ion movement. It contributes to the formation of ionic associates [EPOYAN *et al.* 2014a; KLASSEN 1973; ZENIN, TYAGLOV 1994]. Ionic associates are the nuclei of a new submicroscopic phase and the colloidal stage of dispersion, which promotes the formation of crystallization and coagulation centers [EPOYAN *et al.* 2014a]. The increased number of nuclei and the shortened crystallization time are connected with the impact of the magnetic field on admixtures contained in treated water.

Experiments show that the use of a composite as a component of the PHMGH and aluminum chlorohydrate simplify substantially the technological cycle, permit to achieve better treatment as compared with typical coagulants (Tab. 4). Beside bactericidal processing, water conservation takes place in storage tanks, whereas bio-growth and sedimentation decay is prevented, and the corrosive activity of circulating water diminishes [KVARTENKO *et al.* 2018].

However, while using the PHMGH as an independent reagent along with the bactericide effect in the filtrate, we can observe the substantial increase in the PO value (Tab. 4, scheme 1) on account of the transfer of high-molecular organic structures contained in this preparation into the solution. After the subsequent introduction of the PHMGH and coagulant solutions to treated water, and the time interval not less than 10 min, we can observe either an insignificant increase in PO (Tab. 4, scheme 2) or its insignificant decrease (Tab. 4, scheme 4) depending on the polymer concentration. In this case, only a part of high-molecular compounds transferring into the emulsified solution during polymer dissolvent is connected and removed through the coagulation process.

While using only coagulant solution as a reagent (Tab. 4, schemes 3, 5, 7) with its increased dosage, we can observe an increase in treatment efficiency. However, it is highly possible that microorganisms (bacteria, microalgae, fungi, spores, viruses) are preserved in the treated water. This contributes to the further development of such processes as bio-growth, bio-destruction, and decay in circulating water supply from vehicle transport enterprises (VTE).

Results of our investigations permit to conclude that the most efficient is the simultaneous introduction of solutions of aluminum chlorohydrate and the PHMGH to treated water (Tab. 4). In this case, a comprehensive removal of emulsified admixtures, oils, and oil products takes place. To achieve deeper treatment and removal of dissolved complicated oxidized organic substances, it is possible to introduce an oxidizer (O_3) together with a powder-like activated carbon of $50\text{--}100 \text{ mg}\cdot\text{dm}^{-3}$.

Besides, the research found the possibility of removing heavy metal ions by forming non-soluble Me-PHMGH complexes in water. At neutral pH values and during 30–60 min., the PHMGH practically completely settled salts of copper, lead, etc. According to data available, metals such as Fe(III), Pb(II), Cd(II), Cu(II), and Zn(II) are contained in products of interaction with

Table 4. Waste water quality parameters before treatment depending on technological scheme used

No.	Basic technological scheme Dose of reagent (mg·dm ⁻³)	Waste water quality parameters			
		before treatment		filtrate	
		PO (mg O·dm ⁻³)	pH	PO (mg O·dm ⁻³)	pH
1	$\left[\frac{\text{PHMGH}}{10}\right] \rightarrow [F]$	24	8.4	47	-
2	$\left[\frac{\text{PHMGH}}{10}\right] \rightarrow \left[\frac{C}{30}\right] \rightarrow [F]$			28	-
3	$\left[\frac{C}{30}\right] \rightarrow [F]$			14.4	-
4	$\left[\frac{\text{PHMGH}}{1}\right] \rightarrow \left[\frac{C}{30}\right] \rightarrow [F]$			18	8.15
5	$\left[\frac{C}{50}\right] \rightarrow [F]$	24.8	8.4	9.09	7.40
6	$\left[\frac{C}{50} + \frac{\text{PHMGH}}{2}\right] \rightarrow [F]$			8.64	7.60
7	$\left[\frac{C}{100}\right] \rightarrow [F]$	24	8.4	7.2	7.15
8	$\left[\frac{C}{100} + \frac{\text{PHMGH}}{2}\right] \rightarrow [F]$			6.72	7.20
9	$\left[\frac{C}{100} + \frac{\text{PHMGH}}{2}\right] \rightarrow [\text{O}_3] \rightarrow [F]$	24	8.2	6.4	7.80
10	$\left[\frac{C}{100} + \frac{\text{PHMGH}}{2}\right] \rightarrow \left[\text{O}_3 + \frac{\text{ACP}}{100}\right] \rightarrow [F]$	28	8.4	5.4	7.65

Explanations: PHMGH = polyhexamethyleneguanidine hydrochloride, PO = permanganate oxidizability (mg O·dm⁻³), $\left[\frac{\text{PHMGH}}{10}\right]$ = injection of a solution of PHMGH / dose (mg·dm⁻³), $\left[\frac{C}{30}\right]$ = coagulant input / dose (mg·dm⁻³), [F] = filtration, $\left[\frac{C}{50} + \frac{\text{PHMGH}}{2}\right]$ = reagents injection together, [O₃] = ozonation, $\left[\text{O}_3 + \frac{\text{ACP}}{100}\right]$ = ozonation and activated carbon powder sharing.

Source: own results.

the PHMGH in the form of hydrolyzed ions regardless which mechanism forms Me-PHMG compounds [NYZHNYK *et al.* 2009].

Results of studies permitted to suggest improvement to the technological scheme of treating storm and circulating waters from VTEs and car-washing installations (Fig. 4) with two-stage reagent treatment.

The novelty of this technology is the combined use of improved mechanical, physical-chemical and chemical methods in joint treatment of circulating and rain waters from VTE as a result of their subsequent treatment by composite reagents in the composition of the PHMGH and by aluminum chlorohydrate (Stage I) through phase separation at thin-layer settler and by processing it in the magnetic field in the presence of aluminum chlorohydrate (Stage II) through phase separation into flotation and filtration blocks. The suggested technology envisages the integrated use of both known and our improved methods to conduct the

efficient treatment of water and removal of dissolved organic compounds, emulsions, and oil products, ions of heavy metals, surface active substances, suspended particles and microorganisms. To prevent the biological growth in the circulation system and keep it free from mechanical admixtures and microorganisms, the optimal initial concentration of the PHMGH in the treated water is 0.01–0.02% (100–200 ppm). For the efficient conservation of circulating water for a month or more the remaining concentration of the PHMGH should not be less than 0.005–0.01% (50–100 ppm). For comparison, the treatment with chlorine provides a reliable protective effect that lasts only for a week. At the same time, corrosive properties increase substantially.

To achieve more efficient protection against biological growth on the inner surface of reception reservoirs (3) and buffer capacities (6, 9, 10), it is necessary to cover them with special waterproof PHMGH paint coating.

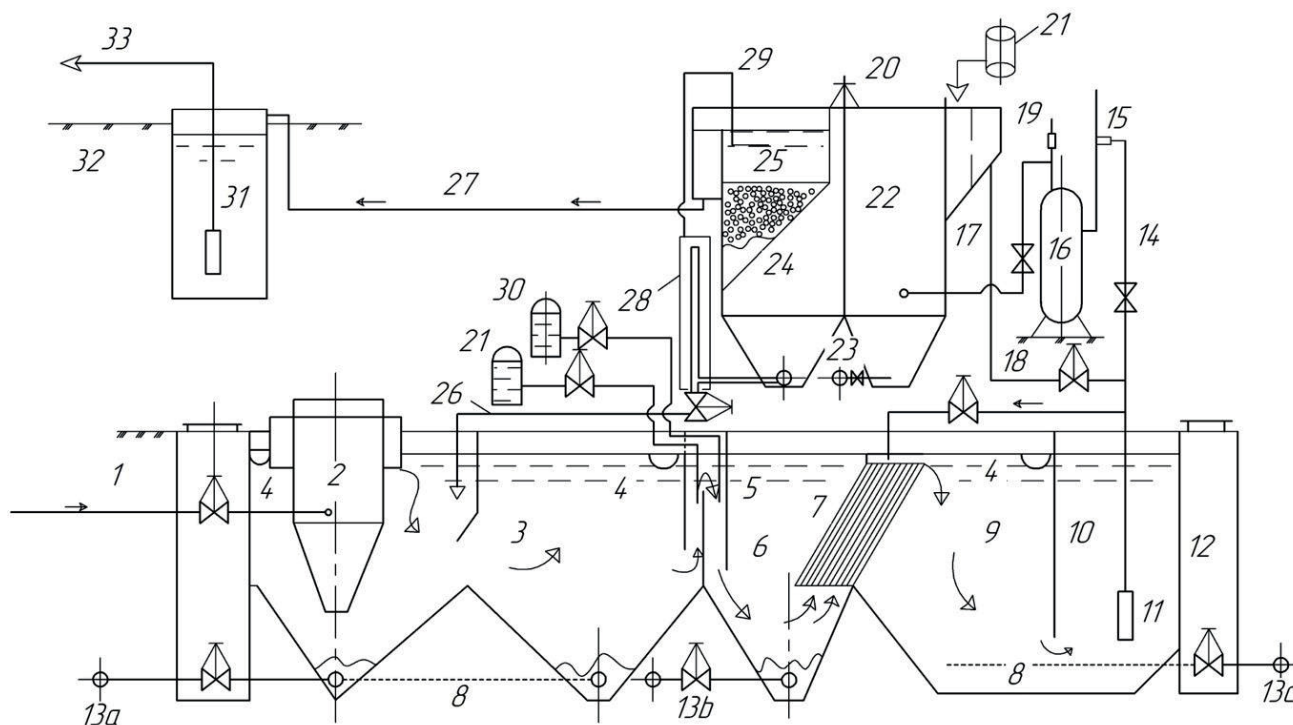

Fig. 4. Technological scheme of joint treatment of storm and circulating waters of auto transport enterprises (ATE); 1 = feeding storm and circulating waters for treatment; 2 = tangential sand trap; 3 = reception reservoirs; 4 = equipment for collecting oil; 5 = mixer; 6 = buffer capacity; 7 = block of thin-layer settlers; 8 = pipelines for sediment takeoff; 9, 10 = capacities for collecting preliminarily treated water; 11, 31 = pumps; 12 = dry chambers of regulation; 13a, 13b = pipelines of emptying and takeoff of washing waters, 13c = emptying and takeoff of washing waters; 14 = pipeline for feeding water to ejector 15; 16 = saturator; 17 = block-mixer of magnetic processing; 18 = pipeline of feeding water to flotator; 19 = feeding water-air emulsion; 20 = passageway; 21 = dose meters of coagulant solution; 22 = flotator; 23 = discharge of sediment from flotation plant operator; 24 = foam polystyrol filter; 25 = washing tank; 26 = filtrate discharge; 27 = takeoff of filtrate; 28 = hydro-robot; 29 = pipe of vacuum break-down; 30 = metering pump of polyhexamethyleneguanidine hydrochloride (PHMGGH) solution; 32 = capacity for discharging treated water; 33 = water supply to car washing installation; source: own results

CONCLUSIONS

The studies determined the possibility of increasing efficiency of treatment of storm and circulating waste water from vehicle transport enterprises (VTE) by using a constant magnetic field of 30–40 mT and the subsequent water treatment by the solution of aluminum chlorohydrate. By increasing the distance between magnets, the decreased induction value of constant magnetic field causes, for example, the decreased treatment efficiency. Based on comparative investigations of various technological schemes of treatment, it was established that a composite contained in polyhexamethyleneguanidine hydrochloride (PHMGGH) and aluminum chlorohydrate are more efficient reagents. The extent of treatment increases by 25% as compared with the usual coagulant. Besides, heavy metals settle by forming Me-PHMGGH complexes non-soluble in water, and disinfection/decontamination takes place in water storage reservoirs and pipelines. To improve the technology, results of the research suggest to use reagents for treatment of storm and circulating waters.

REFERENCES

BARBOSA A.E., FERNANDES J.N., DAVID L.M. 2012. Key issues for sustainable urban stormwater management. *Water Research*. Vol. 46. No. 20 p. 6787–6798. DOI 10.1016/j.watres.2012.05.029.
 BIKUNOVA M.V. 2000. Sovershenstvovaniye malogabaritnykh ustanovok oborotnogo vodosnabzheniya stantsiy moyki avtomobiley [Im-

proving small-sized water recycling plants for car wash stations [online]. PhD Thesis. Penza. Penza State Academy of Architecture and Civil Engineering pp. 135. [Access 10.06.2020]. Available at: <http://tekhnosfera.com/sovershenstvovanie-malogabaritnykh-ustanovok-oborotnogo-vodosnabzheniya-stantsiy-moyki-avtomobiley>

CHAYKA L. 2019. Analiz prychny nehatyvnoho vplyvu avtomyyok na stannavkolyshn oho seredovyscha mista Makiyivky DOU VPO [The reasons analysis of the negative ecological impact of carwashes on the environmental condition of Makeyevka] [online]. *Vestnik Donbasskoy natsional'noy akademii stroitel'stva i arkhitektury*. Sbornik nauchnykh trudov. Vyp. 139. No. 5 p. 47–52. [Access 15.06.2020]. Available at: [http://donnasa.ru/publish-house/journals/vestnik/2019/vestnik_2019-5\(139\).pdf](http://donnasa.ru/publish-house/journals/vestnik/2019/vestnik_2019-5(139).pdf)
 EPOYAN S., DUSHKIN S., AYRAPETYAN T. 2014a. Teoreticheskiye osnovy aktivirovaniya rastvorov koagulyanta sul'fata alyuminiya pri podgotovke pit'yevoy vody [Theoretical bases activation coagulant solutions of aluminum of sulfate for preparation of drinking water]. *MOTROL. Motoryzatsiya i Energetyka Rolnictwa*. Vol. 16. No. 6 p. 11–18.
 EPOYAN S.M., LUKASHENKO S.V., GETMANETS N.I. 2014b. Tekhnologiya ochistki neftesoderzhashchikh poverkhnostno-livnevnykh stochnykh vod [Technology of treatment of oil containing surface storm waste water]. *MOTROL. Motoryzatsiya i Energetyka Rolnictwa*. Vol. 16. No. 6 p. 61–68.
 GETMANTSEV S.V., NECHAEV I.A., GANDURINA L.V. 2008. Ochistka proizvodstvennykh stochnykh vod koagulyantami i flokulyantami [Wastewater treatment by coagulants and flocculants]. Moscow. ACB. ISBN 978-5-93093-573-8 pp. 272.

- KLASSEN V.I. 1973. Voda i magnit [Water and a magnet]. Moscow. Nauka pp. 112.
- KVARTENKO A.N., ZHURBA M.G. 2010. Teoreticheskoye obosnovaniye konditsionirovaniya podzemnykh vod slozhnogo fiziko-khimi-cheskogo sostava v postoyannom magnitnom pole [Underground water conditioning in constant magnetic field. Theoretical issues] [online]. Voda: Khimiya i ekologiya. No. 11 p. 24–32. [Access 15.06.2020]. Available at: <https://www.elibrary.ru/item.asp?id=15518576>
- KVARTENKO O., SABLII L., KOVALCHUK N., LYSYTSYA A. 2018. The use of the biological method for treating iron containing underground waters. Journal of Water and Land Development. No. 39 p. 77–82. DOI 10.2478/jwld-2018-0061.
- LEE K.E., MORAD N., POH B.T., TENG T.T. 2011. Comparative study on the effectiveness of hydrophobically modified cationic polyacrylamide groups in the flocculation of kaolin. Desalination. Vol. 270. No. 1–3 p. 206–213. DOI 10.1016/j.desal.2010.11.047.
- LYSYTSYA A.V., MANDYHRA Yu.M., BOYKO O.P., ROMANISHYNA O.O., MANDYHRA M.S. 2015. Dyferentsiyna chutlyvist' mikroorhanizmiv do poliheksametylenhuanidynu [Differential sensitivity of microorganisms to polyhexamethyleneguanidine] [online]. Microbiologichny zhurnal. Vol. 77. No. 5 p. 11–19. [Access 15.06.2020]. Available at: http://www.imv.kiev.ua/images/doc/MB/2015/UMJ_05_2015.pdf
- MITCHENKO T.Y., MAKAROVA N.V., SHEVCHUK O.A., SUS' M.O. 2010. Porivnyal'ni doslidzhennya ta vybir optimal'noho sorbentu dlya vydalennya nadlyshku poliheksametylenhuanidynu z vodnykh seredovyshch [Comparative studies and selection of the optimal sorbent for removing excess polyhexamethylene guanidine from aqueous media] [online]. Visnyk Natsional'noho tekhnichnoho universytetu. Ser. Khimiya, khimichni tekhnolohiyi ta ekolohiya. No. 11 p. 130–137. [Access 25.06.2020]. Available at: <http://repository.kpi.kharkov.ua/handle/KhPI-Press/19207>
- NYZHNYK T.YU., NYZHNYK YU.V., STRYKALENKO T.V. 2009. K analizu rezul'tatov primeniya reagenta neokislitel'nogo deystviya «Akvaton» na predpriyatiyakh vodopodgotovki [To the analysis of results of application of reagent of non-oxidizing action “Aquatone” at the water treatment enterprises]. Vodopostachannya ta vodovidvedennya. No. 3 p. 41–46.
- SADILLO R.M. 2007. Obespecheniye ekologicheskoy bezopasnosti zapravochno-moyechnogo kompleksa avtomobiley putem ratsionalizatsii yego vodnogo khozyaystva [Ensuring the environmental safety of the refueling and washing complex of cars by rationalizing its water economy]. Abstract of the dissertation of the PhD of technical sciences. Volgograd. South-Russian State Technical University pp. 16.
- SETO K.C., GÜNERALP B., HUTYRA L.R. 2012. Global forecasts of urban expansion to 2030 and direct impacts on biodiversity and carbon pools. Proceeding of the National Academy of Sciences of the United States of America. Vol. 109 p. 16083–16088. DOI 10.1073/pnas.1211658109.
- YANUSHEVSKA O. I. 2019. Vodoochysna tekhnolohiya utylizatsiyi vidkhodiv rizannya monokystaliv kremniyu [Water treatment technology for utilization of cutting waste of silicon single crystals]. Dissertation scientific degree of candidate of technical sciences. Kyiv. National Technical University of Ukraine “Kyiv Polytechnic Institute Igor Sikorsky” pp. 135.
- ZENIN S.V., TYAGLOV B.V. 1994. Gidrofobnaya model' struktury assotsiatov molekul vody [A hydrophobic model of the structure of associates of water molecules]. Zhurnal fizicheskoy khimii. Vol. 68. No. 4 p. 636–641.
- ZHURBA M.G., KVARTENKO A.N. 2009. Aktivatsiya bioflokulyatsionnykh protsessov vodopodgotovki v postoyannom magnitnom pole [Activation of bioflocculating water treatment processes in permanent magnetic field] [online]. Voda: Khimiya i ekologiya. No. 3(9) p. 20–27. [Access 25.06.2020]. Available at: <https://www.elibrary.ru/item.asp?id=13620331>