

EDYTA SERMET¹, MAREK NIEĆ², PRZEMYSŁAW BOKWA³

Geological conditions of borehole sulphur mining using the underground smelting method

Introduction

An important feature of borehole sulphur mining using the underground melting method is the impossibility of direct observation of its effects within the deposit. They depend on:

- ◆ the geological and hydrogeological features of exploited deposit which affect sulphur smelting process;
- ◆ technological factors – the pressure and quantity of the injected hot (superheated) water, its injecting time, and the amount of extracted smelted sulphur.

Technological factors can be controlled, but geological and hydrogeological conditions can only be recorded. Native sulphur deposits mined using the underground melting method are characterized by a complex structure, which is the result of many processes. Good recognition of geological and hydrogeological deposit features, exploitation results, is im-

✉ Corresponding Author: Edyta Sermet; e-mail: sermet@agh.edu.pl

¹ AGH University of Science and Technology, Kraków, Poland;

ORCID iD: 0000-0002-0360-9642; e-mail: sermet@agh.edu.pl

² Mineral and Energy Economy Research Institute, Polish Academy of Sciences, Kraków, Poland;

ORCID iD: 0000-0001-6689-034X; e-mail: mark@min-pan.krakow.pl

³ KD SA w Sandomierzu, Sandomierz, Poland



© 2021. The Author(s). This is an open-access article distributed under the terms of the Creative Commons Attribution-ShareAlike International License (CC BY-SA 4.0, <http://creativecommons.org/licenses/by-sa/4.0/>), which permits use, distribution, and reproduction in any medium, provided that the Article is properly cited.

portant for formulating the rules of controlling the course of exploitation in order to achieve the best sulphur recovery at the lowest possible water consumption and to reduce operating costs.

The method of underground sulphur melting was introduced by H. Frasch at the end of the 19th century for the exploitation of deposits in salt domes (Haynes 1959). It was applied in Poland in the 1960s for the exploitation of deposits not related to salt domes (Gutman and Kwiecień 1992). The exploitation of such deposits, which are hydrogeologically open, forced the modification of the classical Frasch method (Żakiewicz 1975), its adaptation to the specific features of such deposits, and the development of rules for its safe management (Uberman 1972, 1975; Klich 1990; Filcek 1992; Tajduś 1992; Flisiak 1993; Hajdo et al. 2007). Mathematical description and forecasting of sulphur smelting has also been performed (Krajewski 1970; Cielenkiewicz and Głąb 1972; Marcinowski and Kaliszak 1979; Kaliszak 1984). The exploitation process was also visualized and studied with the use of material model tests (Michalski 1973, 1974). Research on borehole sulphur mining using the underground melting method was also conducted in Russia (former Soviet Union – USSR) (Arens and Gajdin 1978). The exploitation results were studied in deposits, similar to those in Poland, in the Ukraine and Uzbekistan (Arens et al. 1977).

Studies focusing on the exploitation technology and the theoretical description of the sulphur melting processes which occur in the deposit, assume homogeneous deposit features. However, it was noted that a varied deposit structure has an impact on the course and effects of mining. The study of this impact usually considers the basic deposit features only, such as its thickness, sulphur content and abundance (amount of sulphur per 1 m² of deposit (ton/m²)), as well as the permeability of rocks of sulphur-bearing formations (Krajewski 1973). It was also noticed that the course of exploitation and its results (development of the smelting zone, water consumption, rate of sulphur recovery, and post-mining subsidence) are also influenced by:

- ◆ deposit heterogeneity and vertical and horizontal lithological diversity of sulphur-bearing formations (Nieć 1969b, 1969a; Schlegel 1975; Wilk and Wranka 1976);
- ◆ the frequent occurrence of barren limestone within the deposit, or in either its top or floor (Nieć et al. 1972; Krajewski and Michalski 1975; Nieć 1975);
- ◆ the occurrence of clay intercalations in the deposit (Stępniewski 1972; Kokesz and Nieć 1975; Wranka 1975);
- ◆ the different smelting ability of sulphur-bearing rocks – “sulphur smeltability” (Nieć 1969a; Rybicki 1973);
- ◆ the anisotropy in variations of deposit thickness and sulphur content (Uberman 1972).

However, these particular deposit features were not considered in the management of sulphur mining, if exploitation was not particularly problematic. In the case of deposits that are difficult to mine, it is necessary to pay attention to those geological factors that affect or may affect the flow of hot water in the deposit and the course of the sulphur melting process.

The aim of the present paper is:

- ◆ to summarize the state of knowledge on the impact of the variations of deposit structure and lithological features of sulphur-bearing formations on the course and effects of mining;
- ◆ to draw attention to the importance of detailed research on these factors in order to use them in the management of mining operations and to control the exploitation process.

1. Principles of sulphur exploitation using the underground smelting method

The philosophy of sulphur mining using the underground smelting method is based on specific properties of sulphur: its melting point of 119.8°C and low viscosity at temperatures up to approx. 160°C, above which it polymerizes and transforms into a high-viscosity polymorphic variety (plastic sulphur μ).

The principle of the underground smelting method is the injection of superheated water through boreholes into the deposit under a pressure of 8–10 atm and a temperature of around 160–170°C at the borehole head. The melted sulphur flows into the same borehole, from where it is lifted to the surface by the compressed air (“airlift” system), which foams it.

Exploitation boreholes are drilled at intervals of 30–60 m and arranged in a triangular grid.

At some distance from the producing boreholes, additional wells (bleeding wells) are drilled in order to reduce the overpressure caused by the injection of large amounts of hot water and to control the direction of its flow. The cooled water collected from them is heated up and again pumped into the deposit; therefore, a closed water circuit is formed (Kirejczyk 1996).

2. Geological conditions of borehole mining efficiency

The conditions necessary for borehole mining are:

- ◆ the impermeable overburden of rocks and its sufficient thickness for balancing the pressure of hot water injected into the deposit;
- ◆ impermeable or low permeable rocks below the deposit;
- ◆ permeable rocks forming the deposit.

The efficiency of exploitation is determined by the resource utilization rate (sulphur recovery factor; Górecki and Sermet 2019) and the consumption of hot water (or heat) per ton of sulphur. The course of exploitation and its results depend primarily on the sulphur abundance in the deposit (ton/m^2) and the permeability of the rocks of sulphur-bearing formations (Table 1). The variation of these two features is of particular interest.

Table 1. Conditions of borehole sulphur mining process
 Tabela 1. Warunki eksploatacji siarki metodą podziemnego wytopiania

Deposit features	Exploitation conditions	
	good	satisfactory
The average sulphur content [%]	above 20	10–20
Sulphur smeltability [%]	above 70	40–70
The dominant ore texture	patchy-spotted, ribbon, veined, breccia	nodular, spotted-impregnated, streaky-impregnated
Type of limestone porosity	cavernous limestone	low cavernous limestone, porous
General hydrogeological conditions	hydrogeologically closed	partly hydrogeologically open
Water consumption at 1 MPa pressure [m ³ /h/meter of deposit profile]	0.5–1	0.1–0.5 or 1–3
Overburden	impermeable	low permeable
Formations below the deposit	impermeable or low permeable	less permeable than the deposit
Deposit thickness [m]	above 10	3–10
The thickness of the barren impermeable interlayers in the deposit [m]	absence	1–3
The share of barren porous limestones in sulphur bearing series [%]	0	up to 10
The depth of the top of the deposit [m]	120–300	80–120 or 300–500
		below 10
		below 40
		impregnated (dispersed)
		compact limestone, non-cavernous, marls, clays
		hydrogeologically open
		below 0.1 or above 3
		permeable
		more permeable than the deposit
		below 3
		above 3
		over 10
		below 80 or above 500

Based on (Arens and Gajdin 1978), modified and completed.

3. The main features of sulphur deposits in Poland

The native sulphur deposits in Poland mined using the underground smelting method are located in the Carpathian Foredeep, within the gypsum formation of the Miocene age (referred to as Krzyżanowice formation). They are underlined by Baranów beds (sands and mudstones) and Lithotamnium limestones and covered by marly clays of Pecten (Spirialis) beds and overlying Krakowiec clays (claystones with subordinate sandy intercalations). The whole series of sulphur-bearing rocks, that occur between the footwall Baranów beds and the overburden Pecten beds is called the “deposit series”.

Native sulphur deposits are formed by sulphur-bearing limestones, which were a product of the reduction of gypsum by hydrocarbons with the participation of bacteria (Pawłowski et al. 1979; Nieć 1992b). They therefore occur within gypsum formations, replacing them in limited areas.

Gypsums not replaced by sulphur-bearing limestone are present at the periphery of sulphur deposits. They are also sometimes preserved below, less often over the top of sulphur bearing limestone formations, or within it, in the form of irregular nests and pockets, known as “gypsum islands”. The boundaries between gypsum and sulphur-bearing limestones are clear but are vertically and horizontally irregular and are often marked by few-centimeter transition zone of the replacement phenomena.

Large-crystalline gypsum forms the lower part of the gypsum series, while fine-grained, compact, thinly laminated gypsum occurs in the upper part. Depending on the sedimentation conditions, a series of layers with different lithological features can be distinguished in the profile of gypsum series (Bąbel et al. 2015). Gypsum breccia often appear in the central part or the top of the series (Kubica 1992). Sulphur-bearing limestones replacing gypsum are varied accordingly. Generally, these are fine-grained (micritic or microsparite) rocks. In limestones replacing large crystalline gypsum, sulphur forms irregular, patchy aggregates. Among them pseudomorphoses after gypsum crystals often appears. In limestones replacing compact layered gypsum, sulphur forms nodular and streak-like aggregates. In both cases, sulphur usually has a very fine crystalline structure, named the “waxy”. Occasionally, the deposit contains marly layers inherited from argillaceous gypsum.

At a depth of over 200 m, the gypsum is replaced by anhydrite, which in the transition zone to sulphur-bearing limestone replaced by secondary fine-crystalline gypsum. The sulphur-bearing limestone replacing it is finely crystalline, with finely dispersed sulphur, usually distributed in elongated or patchy clusters.

Sulphur-bearing limestones formed as a result of the transformation of gypsum should contain up to about 25% sulphur depending on the content of other mineral components (e.g. clay) in gypsum rock. The high chemical activity of sulphur and its associated mobility makes sulphur-bearing limestones susceptible to further transformations (Pawłowski et al. 1979; Nieć 1986) and sulphur redistribution. It follows the variation of underground water circulation and chemistry as a result of tectonic processes, which change the depth of deposit

location and allows the infiltration of surface water. These make the sulphur content very varied and change its mode of occurrence within the deposit.

The effect of sulphur migration was limestone removal, the formation of cavernous (“skeletal”) limestones and the enrichment in sulphur of limestones in other parts of the deposit. Sometimes, the sulphur also appears in the underlying rocks (e.g. footwall sandstones). The boundary between barren and sulphur-bearing limestones is usually irregular (Figure 1B). The barren cavernous limestones occur at the periphery of some deposits or in a limited area that appears at their top or bottom (Figure 1A). They contain up to a few percent of the remaining sulphur.

The change in the chemistry of connate waters due to the infiltration of surface waters produce the banded recrystallization of limestones and sulphur and the formation of elongated, parallel voids surrounded by crystalline calcite and sulphur (Merlicz and Dacenko 1976; Nieć 1992a, b).

Karst and weathering processes play an important role in shaping the internal structure of the discussed deposits. The karstification of sulphur-bearing limestones is a characteristic feature of all deposits in Poland. It took place under the overburden of younger formations (Nieć 1970). Their results include:

- ◆ Irregular morphology of the top surface of the deposit (Nieć 1970);
- ◆ High cavernosity of limestones, sometimes contributing to the formation of cave-size voids;
- ◆ Formation of irregular nest like, pocket accumulations of clay or clay-limestone breccia and irregular discontinuous clay intercalations in limestone;
- ◆ Disturbances within the overburden rocks, their faulting and folding as a result of subsidence over the karst voids (Nieć 1970), and their fracturing and decreasing with the increasing distance from the top of the deposit (Nieć and Szczepańska 1970; Górecki 1973).

The karstification of the deposit causes huge local variations of its hydrogeological parameters: rapid changes in the porosity of sulphur-bearing limestones and the permeability of the rocks of the deposit series. The karstification of limestones and calcium carbonate removal results in the occurrence of irregular residual clay pockets, often containing limestone particles (argillaceous karst breccia).

The zonal increase of the intensity of the occurrence of clay partings and pockets suggests their relationship with karst phenomena that follow fracture and fault zones. The increased permeability of the deposit series in their vicinity is possible, and this is confirmed by the zonal variations of water consumption for sulphur smelting (Kokesz and Nieć 1975; Nieć 1993).

In the weathered part of the deposit, sulphur limestones become light colored, friable, and highly porous. They contain aggregates of fine-grained, loose sulphur, named as “dusty”.

From the point of view of the diversity of porosity, four main types of sulphur-bearing limestones, can be distinguished:

- ◆ porous and cavernous limestones – usually replacing large crystalline gypsum;
- ◆ compact limestones – finely porous, usually replacing layered gypsum;

- ◆ non-porous limestone – compact, impregnated with sulphur, replacing post-anhydrite gypsum;
- ◆ loose limestones with aggregates of dusty sulphur.

4. Differentiation of internal features of deposits

The complex processes of sulphur-deposit formation causes a great variety in their features: the variations of the properties of sulphur-bearing limestones such as mineral composition, ore texture, porosity (Kubica 1978; Nieć et al. 2019) and large local variations of the internal structure of the whole deposit. Rapid vertical and horizontal transitions from sulphur limestones to barren limestones and the occurrence of unchanged gypsum, forming irregular “islands” within the deposit (Figure 1) are often observed. The sulphur content and the forms of its occurrence (ore textures) are varied; this also applies to the porosity, permeability and mechanical properties of sulphur-bearing rocks and their properties after sulphur smelting.

The complex internal structure of the deposit, which is shaped by many processes, causes a large local variation in the permeability of the sulphur-bearing formations. There are rapid changes from below 0.01 m/d to even more than 10 m/d which take place both horizontally and vertically (Figure 2).

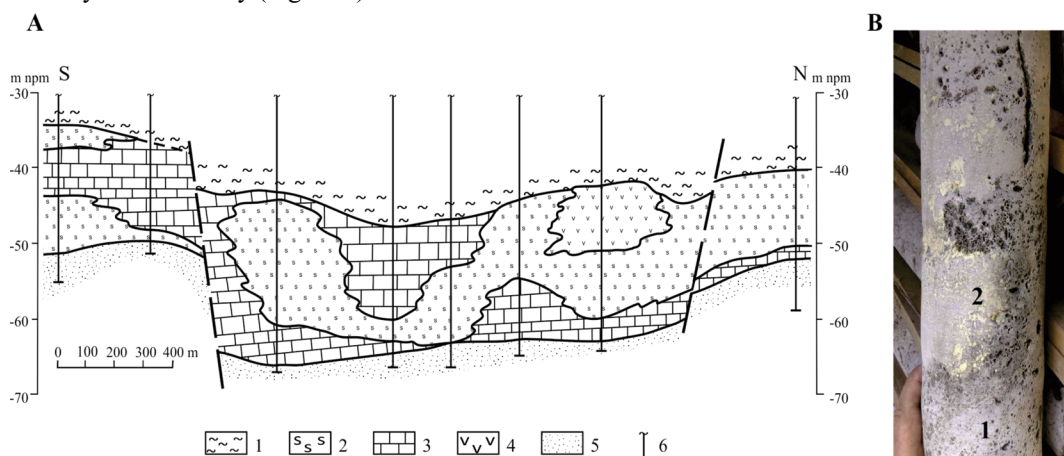

Fig. 1. The local variability of sulphur deposits

- A – Eastern part of the Jeziórko deposit (Nieć et al. 2007), 1 – marly clay (overburden),
 2 – sulphur-bearing limestone, 3 – barren limestone, 4 – gypsum, 5 – Baranów sands, 6 – boreholes
 B – Irregular boundary between barren (1) and sulphur-bearing limestones (2)
 with infiltration sulphur enrichment at the border (Osiek deposit)

- Rys. 1. Lokalne zróżnicowanie wykształcenia złóż siarki
 A – wschodnia część złoża Jeziórko, 1 – gliny margliste (nadkład),
 2 – wapienie siarkonośne, 3 – wapienie płonne, 4 – gipsy, 5 – piaski baranowskie, 6 – otwory wiertnicze
 B – nieregularna granica między wapieniami płonnymi (1) i siarkonośnymi (2)
 z infiltracyjnym wzbogaceniem siarki na granicy (złoże Osiek)

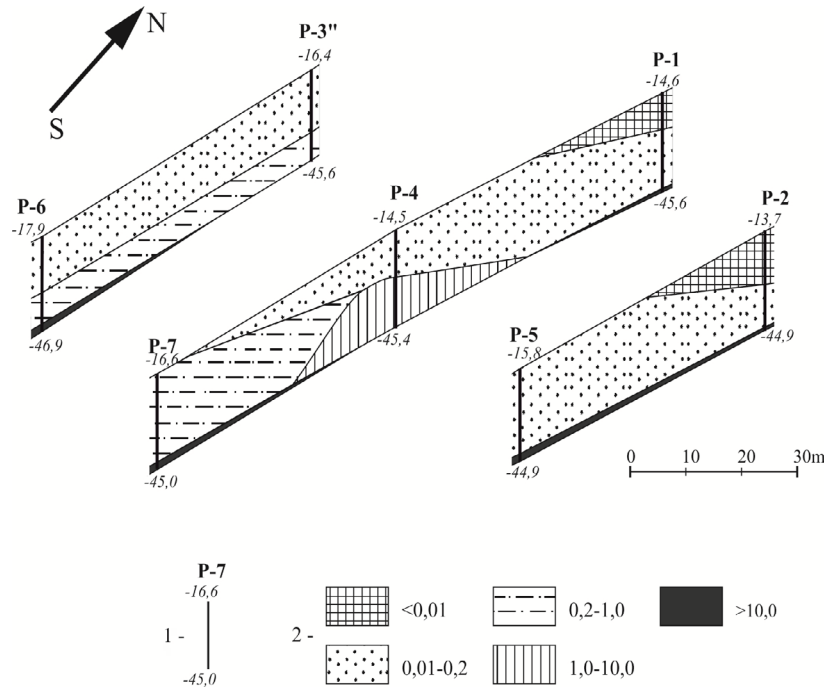

Fig. 2. Permeability variability within the Basznia deposit; based on (Smuszkiewicz 1979), modified
 1 – ordinates of the top and bottom of the sulphur deposit (aquifer) in the borehole;
 2 – filtration coefficient (m/d)

Rys. 2. Zmienność przepuszczalności w złożu Basznia
 1 – rzędne stropu i spągu złoża (warstwy wodonośnej) w otworze wiertniczym;
 2 – współczynnik filtracji [m/d]

An additional factor that changes the internal structure of the deposits are tectonic disturbances. There are faults with displacements of up to several meters (Kubica 1978). These small faults are not always noticeable because the fault zones and their surroundings are obliterated by karst processes, the product of which are residual clays with limestone particles. Faults can hinder the flow of water in zones perpendicular to the fault zone. Meanwhile, the directional flow in zones parallel to the fault zone is possible and can be facilitated due to the fracturing and karstification of limestones.

The presented features of the internal structure of the deposits have an impact on:

- ◆ the speed of hot-water movement in the deposit and the speed of its heating;
- ◆ the speed of the sulphur smelting process and the flow towards the well;
- ◆ the anisotropy in the distribution of injected water and sulphur smelting;
- ◆ the volume of hot water used and the resource recovery rate.

Table 2. Forms of sulphur occurrence; textures of sulphur-bearing limestones
 Tabela 2. Formy występowania siarki; tekstury wapieni siarkonośnych

Processes shaping forms of sulphur occurrence	Textures of sulphur-bearing limestones	Size of sulphur clusters and sulphur type	Ore porosity	Ore smelting ability
Replacement of gypsum	large-crystalline gypsum	up to several centimeters; waxy, crystalline sulphur	often high; cavernous limestones	good, depending on cavernosity 70–90%
	fine-grained, layered, laminated gypsum	a few to several millimeters, waxy sulphur	low; compact limestones, sometimes finely cavernous	average approx. 60%
	syndimentary gypsum breccia	up to several centimeters, waxy, crystalline sulphur	high; cavernous limestones	good, depending on cavernosity 70–90%
Limestone recrystallization	finely disseminated, impregnating, spotted	up to several millimeters, fine crystalline sulphur	very small, practically none	poor, around 30%
	ribbon, banded	up to several millimeters of crystalline sulphur layers alternating with coarse crystalline calcite	high; cavernous limestones	very good; 80–90%
Redistribution of sulphur, karst	spotted (replacement pseudo-breccia), veined, breccia	up to a few, sometimes up to several centimeters, waxy, crystalline sulphur	high; cavernous limestone	very good; 80–90%
Weathering	spotted, finely disseminated, impregnating	up to a few, centimeters, dusty sulphur	high porosity	low

5. Forms of sulphur occurrence, ore texture and its smelting ability

The efficiency of sulphur exploitation using the borehole method depends on the smeltability of the ore, i.e. the ratio of the amount of smelted sulphur to its original content. The efficiency of smelting varies depending on the sulphur content, its size and the distribution of its aggregates and the porosity of the sulphur-bearing rocks, in particular, smelting efficiency depends on the form and size of the pore space (Niec 1969a, 1977, 1992a, b; Rybicki 1973, 1976) – Table 2. The cavernosity of the ore is especially favorable for the easy penetration of hot water. The porosity and the sulphur content are independent ore features.

The process of smelting sulphur within the deposit is irregular. It follows easily in the case of large sulphur aggregates close to caverns and pores. At a temperature of over 95°C, the rhombic sulphur is transformed into a monoclinic form, which is then smelted. The accompanying changes in its volume (by a total of 15%) may cause the sulphur-bearing rock to crack, allowing at least a partial flow of sulphur if the original permeability of the ore is low (Niec 1969b). In sulphur-bearing limestones affected by hot water, a certain amount of sulphur, usually up to few percent, remains in the isolated aggregates or as thin coatings on the walls of caverns (Niec 1984). The molten sulphur, remaining below the liquid sulphur table, fills pores and caverns. After solidifying, it is distinguished by its bright canary color.

6. The development of the smelting zone and the post-exploitation state of the deposit

The smelting process takes place around the borehole, in which the rock temperature reaches at least 120°C. The shape of this space is the result of the penetration and flow of hot water into the rock and heat convection. Water flows mainly in the upper part of the deposit and melted sulphur, due to having a higher density than water, flows down into the bottom part of the borehole. In the lower part of the deposit, water penetration is limited by the stream of liquid sulphur and this zone is heated only by thermal conductivity.

After sulphur smelting, a zone, devoid of it, is formed around the exploitation borehole. In a homogeneous isotropic deposit, its shape determines the temperature distribution near the borehole through which hot water is injected. The gravity flow of sulphur should comply with Darcy's law, but it is modified by the countercurrent of heated water injected under pressure (Krajewski 1972, 1987). As a result, the smelting zone should have the shape of a paraboloidal inverted cone (Figure 3); this is confirmed by modeling studies (Michalski 1973, 1974).

The development of the smelting zone over time depends on three factors:

1. The speed of deposit heating and the resulting heating rate, which depends on the thermal conductivity of the rocks.
2. The permeability of rocks determining the speed of hot water penetration and the flow of molten sulphur.
3. The pressure of the water injected into the deposit.

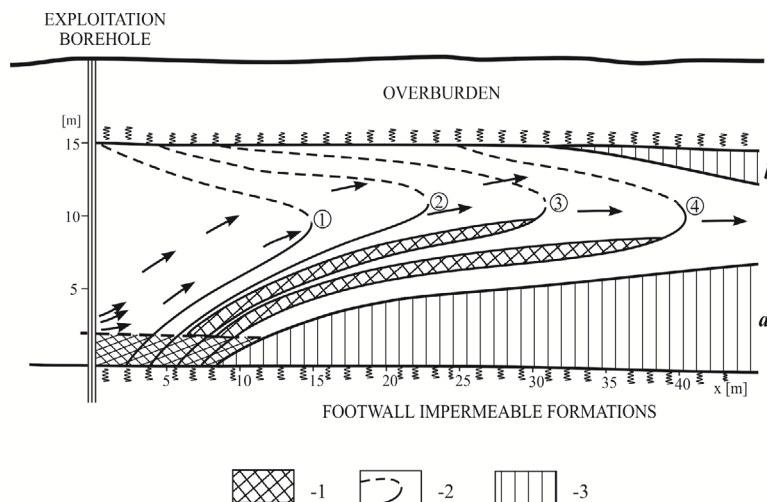

Fig. 3. The theoretical development of sulphur smelting zone (Krajewski 1987)

- 1 – the stream of molten sulphur and its accumulation near the borehole;
- 2 – the isotherm location after 24, 70, 150, 200, and 620 days;
- 3 – non-smelted zone after 620 days in the lower and upper parts of sulphur deposit

Rys. 3. Teoretyczny rozwój strefy wytopu siarki

- 1 – strumień siarki wytopionej i jej nagromadzenie w pobliżu otworu;
- 2 – położenie izoterm po 24, 70, 150, 200 i 620 dniach;
- 3 – strefa niewytopiona po 620 dniach w dolnej i górnej części złoża

At the injected water pressure of $1 \text{ m}^3/\text{h}$ per meter of the deposit in the vertical profile, the deposit is heated within 40 m of the injecting borehole over a period of 100 days (Krajewski 1987). The rate of change in the deposit temperature varies over time between $0.6\text{--}0.9^\circ\text{C}$ a day (Schlegel 1975).

In well-heated deposits that are easy to mine, the angle of the top of the sulphur flow into the borehole ranges from $7\text{--}9^\circ$ in limestones with patchy sulphur aggregates and up to about $10\text{--}13^\circ$ in limestones impregnated with sulphur (Wranka 1978). In low-permeable deposits, in compact and low-permeable limestones, this may increase even up to several dozen degrees (Figure 4).

In a homogeneous deposit, the melting zone should be circular in the horizontal cross section. The interaction between closely located boreholes or the flow of water towards bleeding holes cause modifications of this shape and the directional extension of the smelting zone.

The resource utilization rate by particular exploitation boreholes and the volume of hot water used indicate their zonal variation. This suggests that they depend on the internal features of the deposit structure, particularly on the hydrogeological conditions that determine the flow of injected water and its penetration into the rocks forming the deposit.

The observation of exploitation results are possible in boreholes drilled for the recovery of remaining sulphur. They allow for the finding, that the sulphur smelting process is highly variable in space. Particularly noteworthy is the directional shape of the smelting zone

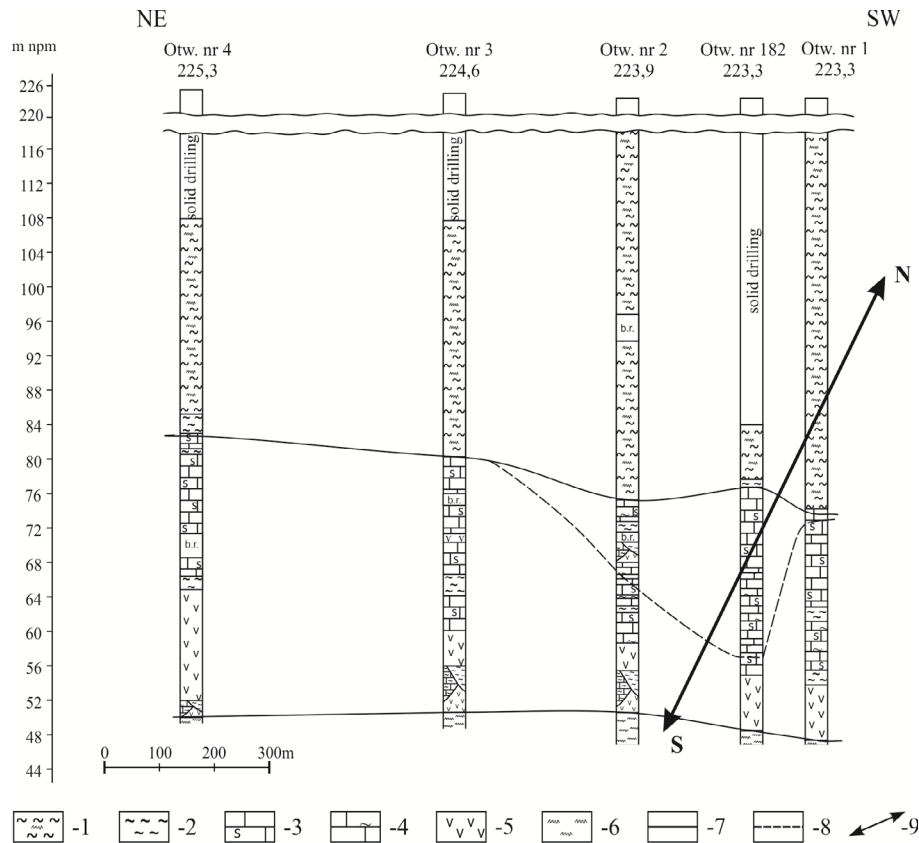

Fig. 4. Smelting zone and the direction of smelting-cone development (Wranka 1978, 1979)

- 1 – marly clays and marls; 2 – clays, 3 – sulphur-bearing limestones; 4 – marly limestones; 5 – gypsum;
 6 – marls; 7 – the top and bottom of the sulphur deposit; 8 – the bottom surface of the melted zone;
 9 – the direction of development of the smelting cone (in the suspected fracture zone)

Rys. 4. Strefa wytopiona i kierunek rozwoju stożka wytopu

- 1 – gliny margliste i margle; 2 – iły, 3 – wapienie siarkonośne; 4 – wapienie margliste; 5 – gips;
 6 – margle; 7 – strop i spąg złoża; 8 – zasięg strefy wytopionej;
 9 – kierunek rozwoju stożka wytopu (w strefie uskoku)

(Kokosz and Nieć 1975; Wranka 1978, 1979; Badawika 1979). This is also confirmed by seismic surveys on exploited parts of the deposit (Dec 2008, 2012). The extension of the smelting zone in certain directions suggests the occurrence of directional diversity of the hydrogeological properties of the rocks forming the deposit series. The modified conditions of water flow and the resulting shape of the smelting zone depend mostly on the varying permeability of deposit forming rocks (Wilk and Wranka 1976). The extension of the smelting zone is facilitated within rocks with elevated permeability, which may be due to the presence of fractures (Wranka 1979), particularly in the walls of faults.

Variations in the permeability of rocks of the deposit series and their smelting ability result in the complex morphology of the smelting zone; in addition, partially melted zones

(Figure 5) and unmelted zones may still remain within the deposit (Figure 6). The clay formations in the deposit play a special role in the development of the smelting zone. If they form continuous interlayers, they force the independent development of smelting zones above and below such impermeable clay partings. Modeling studies (Michalski 1973) suggest that they merge with the progress of the exploitation, although unmelted ore may still remain in the deposit. It has also been observed that clay interlayers limit the water flow and may reduce its consumption (Stępniewski 1972).

Karst phenomena (associated with tectonic disturbances zones) have a significant but varied impact on the conditions of hot-water distribution. They can either increase the permeability of the rocks of the deposit series by increasing their cavernosity, or locally limit it by the presence pocket clusters of residual clays or clay-limestone breccia. Therefore, karstified zones may be favorable for water flow (but with a very complex configuration), and may also cause an irregular form of the exploited area.

Irregular clay accumulations produced by karstification of limestones suggest the possibility of the elevated permeability of rocks in their vicinity. Clay formations may therefore either hinder or facilitate the mining process, depending on the form of their occurrence and location in the deposit profile (Wranka 1975).

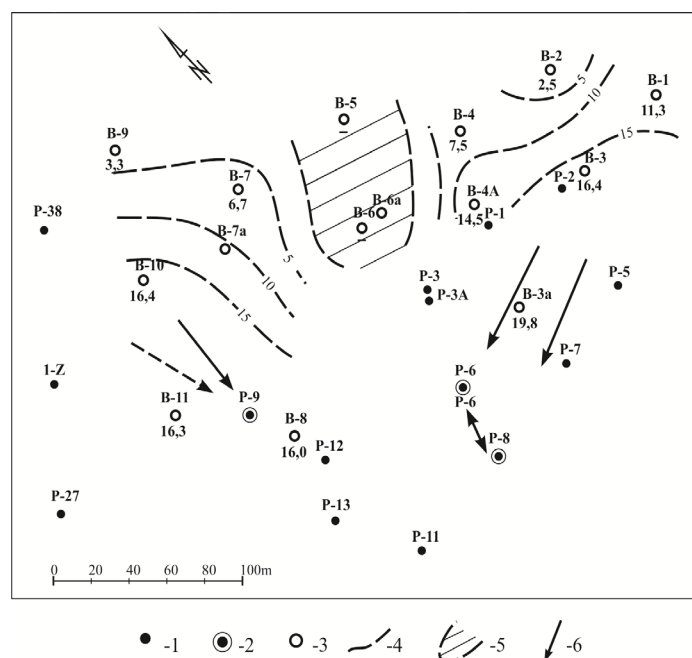

Fig. 5. The thickness of the smelting zone – Basznia 1 deposit (Nieć et al. 2019)

1 – exploratory boreholes; 2 – boreholes; 3 – re-exploitation boreholes; 4 – isarithm of the thickness (upper part of deposit devoid of sulphur by smelting); 5 – unexploited deposit; 6 – sulphur flow directions

Rys. 5. Miąższość strefy wytopionej – złoża Basznia 1

1 – otwory poszukiwawcze; 2 – odwierty; 3 – otwory reeksplatacyjne; 4 – izarytma miąższości (wytopiona górna część złoża); 5 – złożo niewytopione; 6 – kierunki przepływu siarki

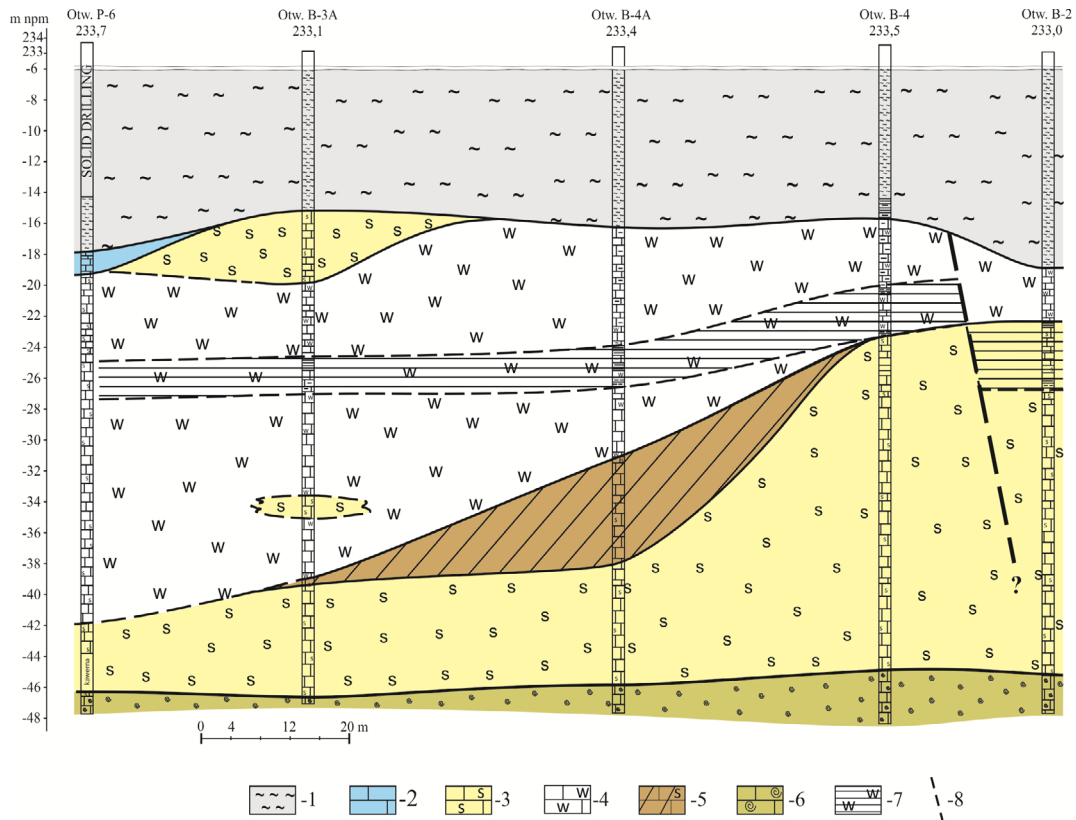

Fig. 6. Cross section through a part of the exploited deposit (Basznia 1)

1 – clays; 2 – barren limestones; 3 – sulphur-bearing limestones, non-melted zone; 4 – sulphur-bearing limestones, melted zone (devoid of Sulphur); 5 – sulphur-bearing limestones, partially melted zone; 6 – lithothamnium limestones; 7 – the zone of clay-marly interbeds; 8 – fault

Rys. 6. Przekrój przez część eksploatowanego złoza (Basznia 1)

1 – gliny; 2 – wapienie płonne; 3 – wapienie siarkonośne, strefa niewytopiona; 4 – wapienie siarkonośne, strefa wytopiona (pozbawiona siarki); 5 – wapienie siarkonośne, strefa częściowo przetopiona; 6 – wapienie litotamniowe; 7 – strefa wkładek gliniasto-marglistych; 8 – uskok

The amount of heat necessary to melt sulphur determines the efficiency of its exploitation. It is measured by the amount of hot water used per ton of sulphur extracted. In the case of deposits with homogeneous permeability, it is inversely proportional to the sulphur content and the sulphur abundance (Figure 7).

Highly cavernous limestones with a low sulphur content or barren limestones in the deposit series significantly increase water consumption from a few to several m^3 per ton of sulphur.

Zones with very high permeability (resulting in hot-water loss) are particularly unfavorable. They may require sealing, for example by injection of clay (or other sealing media), as used in sulphur borehole mining in the United States (Haynes 1959) and Mexico (Niec 1977).

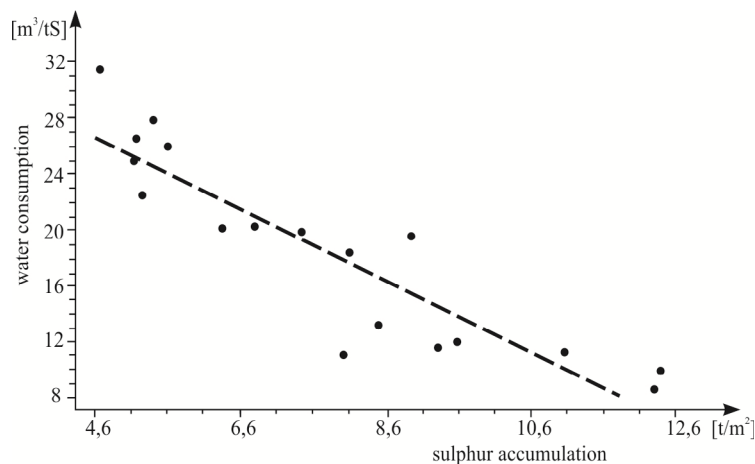

Fig. 7. Water consumption in relation to sulphur accumulation within the deposit (Ślizowski et al. 2000)

Rys. 7. Zużycie wody w zależności od zasobności złoża

7. The impact of an overburden structure on deposit exploitation

The sulphur deposits overburden forms a complex of argillaceous and marly formations referred to as pecten (spirialis) beds and the overlying Krakowiec Clays.

The karstification of the deposit under the overburden rocks caused their subsidence over emerging voids and varied disturbances by up to a few meters over the top of the deposit. These take the form of folding, faulting, and brecciation of clay formations. Above this, in the overlying claystone formations, the joints appear, inclined at an angle of up to around 45°, depending on the plasticity of cracked rocks (Nieć 1970; Nieć and Szczepańska 1970; Górecki 1973). These cracks favor the displacement of rock mass during the post-exploitation subsidence of the overburden. This may cause damage to the boreholes. These cracks can also be routes for hot-water migration to the surface, also facilitated by the intercalations of loose, usually argillaceous, sandstones present in the overburden claystone formations (Górecki 1998).

8. Exploration of the deposit and its post-exploitation features

The primary sources of data on the deposit are cored boreholes drilled at the preliminary exploration stage of the deposit. The basic source of data on deposit features is the geophysical logging of exploitation boreholes (Figure 8). This is composed of gamma ray (PG), neutron-gamma (PNG), gamma-gamma (PGG) and resistivity (PO: N0,1M1,0A, and

A0,1M1,0N) measurements (the possibilities of additional acoustic logging were also investigated (Jarzyna and Bała 2000), but the obtained results were unreliable. The determined barite content was around a few percent, while chemically determined Ba contents were in the range between 0.0021–0.017%), which enables the evaluation of the content of sulphur, clay and carbonate components and the porosity of rocks.

Supplementary information on the deposit, and the shape of the exploited part of it is provided by seismic surveys (Dec 2012). Observations of post-mining surface subsidence are also sources of information on the rate of resource recovery and the shape of the exploited part of the deposit (Maciaszek et al. 1979, 1990).

Geophysical surveys make it possible to determine the basic features of the deposit and its post-mining image. However, they do not provide detailed information on additional features of sulphur-bearing rocks, which is important for the assessment of their behavior during exploitation. These additional features include:

- ◆ ore texture (size and shape of sulphur aggregates) determining sulphur smeltability;
- ◆ the type of porosity (pore size, cavernous structure);
- ◆ the form of clay rocks accumulation;
- ◆ tectonic disturbances (faults joints) which determine the direction of the injected water flow.

Table 3. Types of sulphur-bearing limestones (the main types marked with “+”)

Tabela 3. Rodzaje wapieni siarkonośnych (główne typy oznaczone „+”)

Forms of sulphur occurrence		Porosity/caverning* of limestones				
		Compact, nonporous	Porous* Compact	Porous* loose	Finelycavernous*	Highlycavernous*
		A	B	C	D	E
A	Small, evenly dispersed impregnations	+	(+)			
B	Streak-like clusters or patchy clusters of finely dispersed sulphur	+			+	
C	Fine pocket or nodular, grape-like aggregates, waxy sulphur	+			+	
D	Pocket, patchy aggregates of waxy or crystalline sulphur	+			+	+
E	Veinlet aggregates – waxy or crystalline sulphur	+			+	
F	Streak-banded aggregates, waxy sulphur	+			+	
G	Ribbon, banded aggregates of crystalline sulphur with calcite	+			+	+
H	Nest, patchy clusters, dusty sulphur in loose limestones			+		

* Porosity – pores up to approx. 1 mm, fine caverns approx. 2 to 5 mm, large caverns over 5 mm to several cm.

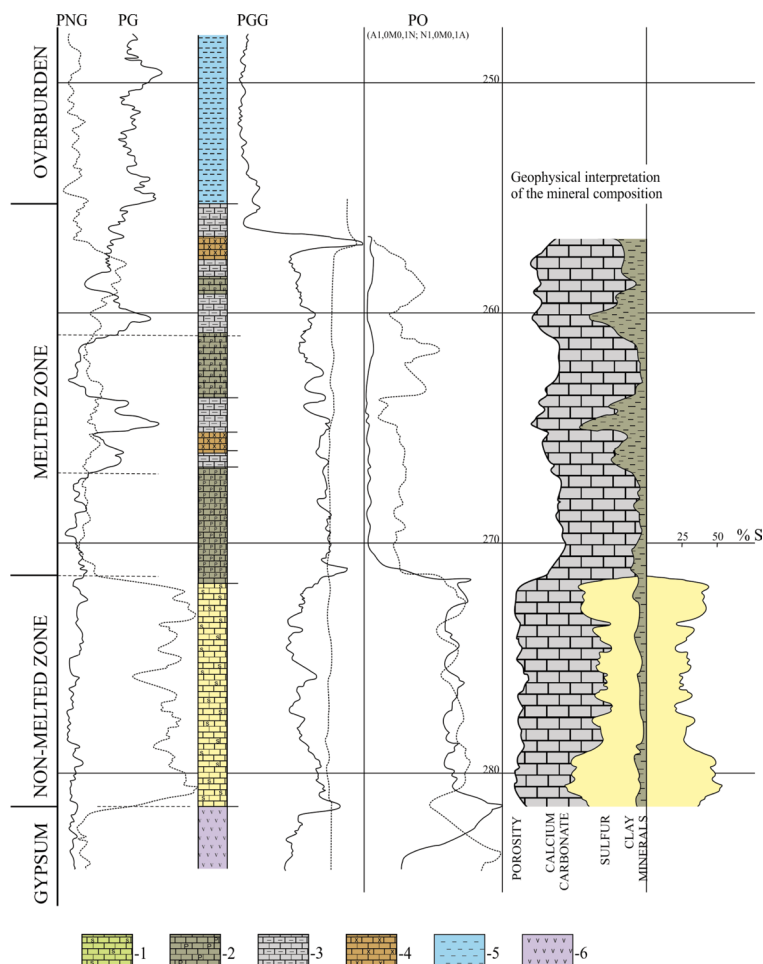

Fig. 8. An example of the geophysical profile of the borehole (Basznia 1, borehole B-11)
 1 – sulphur-bearing limestones; 2 – sulphur resulting from limestone smelting; 3 – marls;
 4 – marly limestones; 5 – marly limestone above the top of the deposit series;
 6 – gypsum (according to the description of gypsum breccia cores)

Rys. 8. Przykładowy profil geofizyczny otworu (Basznia 1, otwór B-11)
 1 – wapień siarkonośny; 2 – strefa wytopiona; 3 – margle; 4 – wapień margliste;
 5 – wapień margliste (nadkładowe); 6 – gipsy

As much knowledge as is possible of the deposit is necessary for the proper understanding and prediction of processes occurring in the deposit during sulphur smelting, for forecasting its effects, and for control over the exploitation process. Therefore, drilling exploitation boreholes as the full core in the deposit series and its direct overburden is recommended because disturbance of the arrangement of overburden formations signals karst phenomena.

Based on direct drill core observations, it is possible to distinguish a number of types of sulphur-bearing limestones and mark them with a combination of appropriate symbols (Table 3), e.g. BC, DB, etc., which should facilitate their description and assessment of possible behavior during exploitation.

Summary and conclusions

Knowledge about the complex and varied features of sulphur deposits is necessary for the proper understanding and prediction of processes that occur in them during sulphur smelting, for forecasting its effects, and for control over the exploitation process. Exploration boreholes provide only general information about the deposit. The geophysical surveys in exploitation boreholes located within the mining field allow the obtaining of more detailed basic geological data about the deposits and on the effects of mining. However, they do not provide information about the special features of the deposit, which is important for predicting the exploitation results which can be obtained based only on direct observations of borehole core samples, for example, the mode of sulphur occurrence (ore textures), the type of porosity and tectonic phenomena. This knowledge would be helpful in successful exploitation management. Therefore, the full-cored drilling of all exploitation and bleeding boreholes is desirable in the deposit series and their direct overburden. The geological conditions of exploitation are interpreted on the basis of point observations in the boreholes and on indirect geophysical data. Given the high variability of the deposit features, such interpretation will always be subject to uncertainty. Simultaneous observations of the work of closely spaced boreholes and obtained exploitation results in confrontation with the interpretation of local geological features of the deposit should enable adequate control and management of the mining process. This is particularly important in the case of deposits that are difficult to exploit or which have been partially exhausted. The Basznia deposit is such an example (Bokwa and Kasztelewicz 2019). The prediction of the shape of sulphur smelting zones, on the basis of tectonic and karstification phenomena deserves special attention.

The research project was financed from AGH University of Science and Technology grant No. 16.16.140.315.

REFERENCES

- Arens et al. 1977 – Arens, W.Ż., Winogradow, Ł.S., Gajdin, A.M., Grinberg, M.I., Podchaluzin, W.S. and Filenko, G.D. 1977. Development and implementation of technologies of underground smelting of sulfur (*Razrabotka i oswoenie tekhnologii podzemnoy vyplavki sery*). Moskwa: Ministerstwo Chemiczeskoj Promyszlennosti SSSR, Gaurdakskej Zawod, Nedra (*in Russian*).
- Arens, W.Ż. and Gajdin, A.M. 1978. Geological and hydrogeological basis of geotechnological methods of mining (*Geologo-gidrogeologičeskiye osnovy geotekhnologičeskikh metodov dobychi poleznykh iskopajemykh*). Moskwa: Ministerstwo Chemiczeskoj Promyszlennosti SSSR, Gaurdakskej Zawod, Nedra, p. 215 (*in Russian*).

- Bąbel et al. 2015 – Bąbel, M., Olszewska-Nejbert, D., Nejbert, K. and Ługowski, D. 2015. The Badenian evaporative stage of the Polish Carpathian Foredeep: sedimentary facies and depositional environment of the selenitic Nida Gypsum succession. [In:] *31st IAS Meeting of Sedimentology*. Kraków: Polish Geological Society, pp. 25–49.
- Badawika, D. 1979 The size of the melting zone in deposits of varying permeability (*Wielkość strefy wytopu w złożach o różnej przepuszczalności*). Conference publication: Problems related to exploitation (*Problemy otworowej eksploatacji złóż siarki o niskiej wodochłonności*). [In:] *Problems related to exploitation of sulfur deposits with low water holding capacity (Problemy otworowej eksploatacji złóż siarki o niskiej wodochłonności)*. Tarnobrzeg: BOINTiE Przemysłu Siarkowego, pp. 1–14 (in Polish).
- Bokwa, P. and Kasztelewicz, Z. 2019. Sulphur mining using Frasch method by the example of “Basznia 1” deposit (*Technologia wydobycia siarki metodą otworową na złożu „Basznia 1”*). *Górnictwo Odkrywkowe* 59(6), pp. 51–59 (in Polish).
- Cielenkiewicz, M. and Głąb, W. 1972. Method for forecasting exploitation indexes for sulfur extraction when using underground smelting system (*Metoda prognozowania wskaźników eksploatacyjnych przy wydobyciu siarki systemem podziemnego wytopu*). *Odwadnianie kopalń i geotechnika* 4, pp. 67–75 (in Polish).
- Dec, J. 2008. Seismic monitoring of the borehole exploitation of sulfur deposits (*Sejsmiczny monitoring otworowej eksploatacji złóż siarki*). *Gospodarka Surowcami Mineralnymi – Mineral Resources Management* 24(2/3), pp. 199–213 (in Polish).
- Dec, J. 2012. High-resolution seismic surveys to identify the Osiek sulfur deposit and to determine dynamic changes occurring as a result of mining (*Wysokorozdzielcze badania sejsmiczne w celu rozpoznania złoża siarki Osiek oraz określenia zmian dynamicznych zachodzących w wyniku eksploatacji*). Kraków: AGH (in Polish).
- Filcek, M. 1992. Protection against hazards associated with borehole sulfur mining (*Badania nad zwalczaniem zagrożeń towarzyszących otworowej eksploatacji złóż siarki*). *Zesz. Nauk. AGH, Górnictwo* 1489, 16(4), pp. 249–253 (in Polish).
- Flisiak, J. 1993. Prediction of the impact of borehole sulfur mining on rock mass deformations (*Prognozowanie wpływu eksploatacji otworowej złóż siarki na deformacje górotworu*). *Zesz. Nauk. AGH, Górnictwo* 1526, 17(3), pp. 163–183 (in Polish).
- Górecki, J. 1973. The microtectonics of the sulfur deposit in Jeziórko near Tarnobrzeg (*Przyczynek do mikrotektoniki złoża siarki w Jeziórku k. Tarnobrzega*). *Zesz. Nauk. AGH, Geologia* 361, 17, pp. 157–163 (in Polish).
- Górecki, J. 1998. Impact of the geological structure of the overburden of the Jeziórko sulfur deposit on borehole exploitation conditions (*Wpływ budowy geologicznej nadkładu złoża siarki Jeziórko na warunki eksploatacji otworowej*). *Gospodarka Surowcami Mineralnymi – Mineral Resources Management* 14(2), pp. 13–27 (in Polish).
- Górecki, J. and Sermet, E. 2019. Consuming resources of sulphur deposits mined by underground melting (*Zużycie zasobów złóż siarki podczas eksploatacji metodą podziemnego wytapiania*). *Górn. Odkr. – Surface mining* 1, pp. 11–17 (in Polish).
- Gutman, E. and Kwiecień, K. 1992. *Polish sulfur (Polska Siarka)*. Warszawa: Zakład Wyd.-Usługowy Adam Konieczny (in Polish).
- Hajdo et al. 2007 – Hajdo, S., Klich, J. and Galiniak, G. 2007. Ecological and technological success in 40 years history of sulphur mining in Poland (*Ekologiczne i technologiczne osiągnięcia w 40-letniej historii górnictwa otworowego siarki w Polsce*). *Górnictwo i Geoinżynieria* 31(3/1), pp. 199–215 (in Polish).
- Haynes, W. 1959. *Brimstone, the Stone That Burns: the Story Of The Frasch Sulphur Industry*. N. York: Princeton [etc.]: D. Van Nostrand Company, Inc., cop.
- Jarzyna, J. and Bała, M. 2000. Measurements and interpretation of well logs in the Jeziórko sulphur deposit, Tarnobrzeg. Poland. *Geological Quarterly* 44(2), pp. 157–166.
- Kaliszak, A. 1984. Modeling of the borehole sulfur mining process (*Modelowanie procesu eksploatacji złóż siarki metodą otworową*). *Prace Inst. Inżynierii Chemicznej Polit. Warszawskiej XIII, 2*. Warszawa: University of Technology, p. 237 (in Polish).
- Kirejczyk, J. 1996. Borehole mining systems of sulfur deposits (*Systemy otworowej eksploatacji złóż siarki*). *Gospodarka Surowcami Mineralnymi – Mineral Resources Management* 12(2), pp. 263–277 (in Polish).
- Klich, J. 1990. A method of directing hole exploitation of sulfur and stabilization of the process in the basic production section of the mine – the control room AKP (*Metoda kierowania otworową eksploatacją siarki i sta-*

- bilizacja procesu w podstawowym ogniwie produkcyjnym kopalni – sterowni AKP). *Zeszyty Naukowe AGH. Górnictwo* 151. Kraków: AGH, p. 105 (in Polish).
- Kokesz, Z. and Nieć, M. 1975. The variability of water production and consumption in the Field I of the Jeziórko mine and its relationship with the use of the deposit (*Zmienność produkcji i zużycia wody na polu I kopani Jeziórko i jej związek z wykorzystaniem złoża*). *Siarka, Zesz. Nauk. Techn. OBR Przemysłu Siarkowego Starkopol*, pp. 43–52 (in Polish).
- Krajewski, R. 1970. Dynamics of sulfur and water flow in borehole mining and its influence on selected accidents and the utilization of the field (*Dynamika przepływu siarki i wody ws. eksploatacji otworowej i jej wpływ na pewne przypadki awarii i na wykorzystanie złoża*). *Ochrona Terenów Górniczych* 12, pp. 5–8 (in Polish).
- Krajewski, R. 1972. The range of borehole sulfur smelting (*Zasięg otworowego wytopiania siarki*). *Zesz. Nauk. AGH*, pp. 5–18 (in Polish).
- Krajewski, R. 1973. Geological problems of borehole sulfur mining (*Problemy geologiczne w górnictwie otworowym siarki*). [In:] *Problems related to borehole exploitation of solid minerals (Problemy eksploatacji otworowej surowców stałych)*. Katowice: Wyd. Śląsk (in Polish).
- Krajewski, R. 1987. Sulfur smelting process during borehole exploitation: a synthetic view (*Proces wytopu siarki przy eksploatacji otworowej w ujęciu syntetycznym*). [In:] *The 'Osiek' sulfur mine and the current problems of sulfur borehole mining (Zagadnienia kopalni siarki „Osiek” w świetle aktualnych problemów górnictwa otworowego siarki)*. Chancza: BOINTiE Przemysłu Siarkowego, pp. 115–145 (in Polish).
- Krajewski, R. and Michalski, A. 1975. Water consumption and deposit utilization during underground sulfur smelting (*Zużycie wody i wykorzystanie złoża przy podziemnym wytopianiu siarki*). *Zesz. Nauk. AGH, Górnictwo*, pp. 7–14 (in Polish).
- Kubica, B. 1978. The possibility of estimating geological parameters important for underground sulfur smelting in the forefield of the mining area (*O możliwości prognozowania istotnych dla podziemnego wytopiania siarki parametrów geologicznych na przedpolu eksploatacji*). *Biul. IG* 309, pp. 147–174 (in Polish).
- Kubica, B. 1992. Lithofacial development of the Badenian chemical sediments in the northern part of the Carpathian Foredeep. *Prace Państwowego Instytutu Geologicznego* 133, pp. 1–64.
- Maciaszek et al. 1979 – Maciaszek, J., Szewczyk, J. and Nieć, M. 1979. Proposal for determining resources, losses and the use of sulfur deposits exploited using underground smelting method (*Propozycja określania zasobów, strat i wykorzystania złóż siarki eksploatowanych metodą podziemnego wytopiania*). *Górnictwo* 3(3), pp. 273–285 (in Polish).
- Maciaszek i in 1990 – Maciaszek, J., Szewczyk, J. and Nieć, M. 1990. Evaluation of the utilization of sulfur deposits based on land deformation in borehole sulfur mining post-exploitation areas (*Ocena stanu wykorzystania złoża siarki eksploatowanego metodą otworową na podstawie poeksploatacyjnych deformacji powierzchni*). *Gospodarka Surowcami Mineralnymi – Mineral Resources Management* 6(4), pp. 687–707 (in Polish).
- Marcinowski, R. and Kaliszak, A. 1979. Mathematical model of heat transfer during borehole sulfur mining. Examination of sulfur wells (*Model matematyczny ruchu ciepła przy eksploatacji siarki metodą otworową. Badanie identyfikacyjne otworów wydobywczych siarki*). *Warszawskie Centrum Studenckiego Ruchu Naukowego*, pp. 47–64 (in Polish).
- Merlicz, B.W. and Dacenko, N.M. 1976. The conditions for the formation of sulfur ores of the Rozdol deposit (*Usloviya obrazovaniya sernykh rud Rozdol'skogo mesto Rozhdeniya*). *Izdatel'skoye obyedineniye Vishcha shkola, Lwów* (in Russian).
- Michalski, A. 1973. The results of modeling studies on the influence of selected geological and technological factors on the course a (*Wyniki badań modelowych nad wpływem niektórych czynników geologicznych i technologicznych na przebieg i efekty otworowej eksploatacji siarki*). [In:] *Problems of borehole exploitation of solid minerals (Problemy otworowej eksploatacji surowców stałych)*. Katowice: Wyd. Śląsk, pp. 101–136 (in Polish).
- Michalski, A. 1974. The process of underground sulfur smelting in the light of modelling studies (*Proces podziemnego wytopiania siarki w świetle badan modelowych*). Kraków: AGH (in Polish).
- Nieć, M. 1969a. Types of sulfur ore textures and their impact on the ore during the smelting process (*Typy tekstur rud siarki i ich wpływ na zachowanie się rudy w trakcie wytopiania*). *Technika Poszukiwań Geologicznych* 30, pp. 34–38 (in Polish).

- Nieć, M. 1969b. The impact of selected geological factors on the effects of sulfur smelting (*Wpływ niektórych czynników geologicznych na efekty wytopiania siarki z rudy*). *Zesz. Nauk. AGH, Special issue: Scientific issues related to sulfur exploitation and production*, pp. 15–23 (in Polish).
- Nieć, M. 1970. Morphology of the top surface of sulphur deposits and its influence on microtectonic deformations of rocks forming the overburden (*Morfologia stropu złóż siarki i jej wpływ na mikrotektonikę skal nadkładu*). *Annales Societatis Geologorum Poloniae* XL(2), pp. 325–342 (in Polish).
- Nieć et al. 1972 – Nieć, M., Michalski, A., Górecki, J. and Rybicki, S. 1972. Optimizing borehole sulfur mining based on geological and modeling data (*Zagadnienie optymalizacji eksploatacji siarki metodą otworową na podstawie danych geologicznych i modelowych*). *Przegląd Geologiczny – Polish Geological Review* 20(7), pp. 322–329 (in Polish).
- Nieć, M. 1975. Water consumption per ton of sulfur during exploitation using underground smelting method (*Zużycie wody na tonę siarki przy eksploatacji metodą podziemnego wytopiania*). *Zesz. Nauk. AGH, Górnictwo*, pp. 63–71 (in Polish).
- Nieć, M. 1977a. The methodology of exploration of sulphur deposits prepared of mining by underground melting (*Metodyka rozpoznawania złóż siarki na potrzeby eksploatacji otworowej*). *Zesz. Nauk. AGH, Geologia* 3(2), pp. 5–81 (in Polish).
- Nieć, M. 1977b. Geological conditions of exploitation of Mexican sulfur deposits (*Warunki geologiczne eksploatacji meksykańskich złóż siarki*). [In:] *Current problems of borehole sulfur mining (Aktualne problemy otworowej eksploatacji siarki)*. Tarnobrzeg, pp. 1–25 (in Polish).
- Nieć, M. 1984. *The condition of the sulfur deposit after exploitation using underground smelting method (Stan poeksploatacyjny złoża siarki objętego podziemnym wytopem)*. [In:] *Górnictwo Surowców Chemicznych. Zbiorniki podziemne. Środowisko naturalne. Mat. Sympozjum (Conference materials)*. Kraków, Poland, pp. 621–629.
- Nieć, M. 1986. Sulfur deposits transforming processes (*Procesy transformujące złoża siarki*). *Przegląd Geologiczny* 34(7), pp. 366–374 (in Polish).
- Nieć, M. 1992a. *Geological conditions of mining of sulfur deposits using underground smelting method. Current state and directions of development of borehole methods in the exploitation of solid raw materials (Geologiczne warunki eksploatacji złóż siarki metodą podziemnego wytopiania. Stan aktualny i kierunki rozwoju metod otworowych w eksploatacji surowców stałych)*. Kraków, Poland (in Polish).
- Nieć, M. 1992b. *Native Sulfur Deposits in Poland*. [In:] *Native Sulfur, Developments in Geology and Exploration*. Littleton: SMME-AIME, pp. 23–50.
- Nieć, M. 1993. Zoning of lithological development and karst phenomena in native sulfur deposits (*Strefowość wykształcenia litologicznego i zjawisk krasowych w złożach siarki rodzime*). [In:] *Konf. nauk. Trzeciorzędowa formacja siarkonośna Zapadliska Przedkarpackiego*. Warszawa, p. 34 (in Polish).
- Nieć et al. 2019 – Nieć, M., Sermet, E. and Bokwa, P. 2019. The importance of geological features of native sulphur deposits for managing their exploitation by underground smelting (*Znaczenie znajomości budowy wewnętrznej złoża siarki dla prowadzenia eksploatacji metodą otworową*). *Górnictwo Odkrywkowe* 60(2), pp. 12–19 (in Polish).
- Nieć, M. and Szczepańska, J. 1970. Microtectonic disturbances of the Grzybów sulfur deposit and its overburden (*Zaburzenia mikrotektoniczne złoża siarki w Grzybowie i jego nadkładzie*). *Technika Poszukiwań Geologicznych* 34, pp. 24–29 (in Polish).
- Pawłowski et al. 1979 – Pawłowski, S., Pawłowska, K. and Kubica, B. 1979. Geology and genesis of the Polish sulfur deposits. *Economic Geology* 74(2), pp. 475–483.
- Rybicki, S. 1973. Geological and engineering problems of borehole sulfur mining (*Geologiczno-inżynierskie problemy otworowej eksploatacji siarki*). *Zesz. Nauk. AGH, Geologia* 20 (in Polish).
- Rybicki, S. 1976. Well logging for the purpose of underground sulfur smelting (*O profilowaniu otworów dla potrzeb podziemnego wytopiania siarki*). *Technika Poszukiwań Geologicznych* 15(61), pp. 29–32 (in Polish).
- Schlegel, J. 1975. Characteristics of sulfated limestone reservoir beds in mining fields based on geophysical surveys (*Charakterystyka osiarkowanych wapieni serii złożowej na polach górniczych na podstawie badań geofizycznych*). *Odwadnianie kopalń i geotechnika* 7, pp. 59–101 (in Polish).
- Ślizowski et al. 2000 – Ślizowski, K., Nieć, M. and Lankof, L. 2000. *Poland's mineral resources. Chemical raw materials. Sulfur (Surowce mineralne Polski. Surowce chemiczne. Siarka)*. Edited by R. Ney. Kraków: MEERI PAS (in Polish).

- Smuszkiewicz, K. 1979. Dynamics of development of the Tertiary repression cone at the “Basznia” sulfur mine (*Dynamika rozwoju stożka represji poziomu trzeciorzędowego w kopalni siarki „Basznia”*). *Problemy otworowej eksploatacji złóż siarki o niskiej wodochłonności. BOINTiE Przemysłu Siarkowego*, pp. 123–142 (in Polish).
- Stępniewski, A. 1972. Some examples of the effect of geological-mining conditions on the course of the hot water sulphur mining (*Przykłady wpływu warunków geologiczno-górnicznych na przebieg eksploatacji otworowej siarki*). *Przegląd Geologiczny* 20(231), pp. 329–332 (in Polish).
- Tajduś, A. 1992. Analysis of the impact of selected natural and technical factors on the working conditions of production casings (*Analiza wpływu wybranych czynników naturalnych i technicznych na warunki pracy kolumn rur eksploatacyjnych*). *Zesz. Nauk. AGH, Górnictwo* 1489(16), pp. 309–324 (in Polish).
- Uberman, R. 1972. Taking into account the anisotropic factor of the deposit when planning borehole sulfur exploitation (*Uwzględnienie współczynnika anizotropii złoża w planowaniu eksploatacji otworowej siarki*). *Zesz. Nauk. AGH, V(Special)*, pp. 255–263 (in Polish).
- Uberman, R. 1975. Planning method for selective sulfur exploitation in borehole mines (*Metoda planowania selektywnej eksploatacji siarki w kopalniach otworowych*). *Zesz. Nauk. AGH, Górnictwo, Special issue*, pp. 1–152 (in Polish).
- Wilk, J. and Wranka, J. 1976. The impact of geological conditions on the course of heating of a sulfur-bearing reservoir beds during borehole exploitation (*Wpływ warunków geologicznych na przebieg nagrzewania siarkonośnej serii złożowej w czasie eksploatacji otworowej*). *Górnictwe Surowce Chemiczne, Biuletyn ZKSChem w Krakowie*, pp. 11–16 (in Polish).
- Wranka, J. 1975. The impact of occurrence and location of clay interbeddings in the deposit on selected parameters of the borehole sulfur min (*Wpływ występowania i położenia przewarstwień ilastych w złożu na wybrane parametry procesu eksploatacji w otworach kopalni siarki*). *Odwadnianie kopalń i geotechnika* 7, pp. 103–110 (in Polish).
- Wranka, J. 1978. *The study on sulfur smelting methods in light of the deposit use (Badania strefy wytopu siarki różnymi metodami w aspekcie wykorzystania złoża)*. Kraków: AGH (in Polish).
- Wranka, J. 1979. Characteristics of technological water flow in the sulfur deposit (*Charakterystyka rozplywu wód technologicznych w złożu siarki*). *Problemy otworowej eksploatacji złóż siarki o niskiej wodochłonności BOINTiE Przemysłu Siarkowego*, pp. 177–190 (in Polish).
- Żakiewicz, B. 1975. Exploitation of bedded sulphur deposits by hydrodynamic method. *Sulphur* 120, pp. 35–43.

GEOLOGICAL CONDITIONS OF BOREHOLE SULPHUR MINING USING THE UNDERGROUND SMELTING METHOD

Keywords

sulphur deposit, geological and mining conditions, borehole exploitation

Abstract

Native sulphur deposits mined using the underground melting method are characterized by a complex structure, which is the result of the many geologic processes which led to their formation.

The resource utilization rate and the consumption of hot water per ton of sulphur are the main criteria of mining effectiveness. They depend on the porosity and permeability of the rocks forming the deposit, the content and mode of occurrence of sulphur (ore texture), and the distribution of rocks with these varying features. Good recognition of geological and hydrogeological deposit features, exploitation results, is important for formulating the rules of controlling the course of exploitation in

order to achieve the best recovery of sulphur with the lowest possible water consumption and to reduce operating costs.

Sulphur deposits are characterized by great local and directional variations in their structure and hydrogeological parameters. This makes the melting process irregular. The flow of hot water and melted sulphur is facilitated in certain directions. As a result, the shape, and distribution and form of exploited parts of the deposit are highly variable. Full information about the deposit is necessary for the proper understanding and prediction of processes that occur in the deposit during sulphur melting, for forecasting its effects, and for controlling the exploitation process. This information is obtained through the lithological description of core samples from exploratory and exploitation boreholes, geophysical borehole logging, and surface seismic surveys.

GEOLOGICZNE UWARUNKOWANIA EKSPLOATACJI SIARKI METODĄ PODZIEMNEGO WYTAPIANIA

Słowa kluczowe

eksploatacja otworowa, złoża siarki, warunki geologiczno-górnictwa eksploatacji

Streszczenie

Polskie złoża siarki rodzimej obecnie eksploatowane są metodą podziemnego wytapiania. Charakteryzują się dość skomplikowaną budową wewnętrzną, będącą wynikiem formujących je procesów geologicznych. Przy stosowaniu metody podziemnego wytapiania szczególnie ważne jest jak najbardziej szczegółowe rozpoznanie cech geologicznych i hydrogeologicznych złoża, mających istotny wpływ na wyniki prowadzonej eksploatacji. Znajomość tych cech jest ważna dla sformułowania zasad kontroli przebiegu eksploatacji, w celu uzyskania jak najlepszego odzysku siarki przy jak najmniejszym zużyciu wody oraz dla obniżenia kosztów prowadzonej eksploatacji.

Wskaźnik wykorzystania zasobów i zużycie gorącej wody na tonę siarki to główne kryteria efektywności wydobywania. Zależą one od następujących cech wykształcenia serii złożowej: porowatości i przepuszczalności skał tworzących złożo, zawartości, rodzaju i sposobu występowania siarki oraz od rozmieszczenia w przestrzeni złoża skał o zróżnicowanych tych cechach.

Złoża siarki rodzimej charakteryzują się dużą lokalną i kierunkową zmiennością budowy wewnętrznej oraz parametrów hydrogeologicznych. Sprawia to, że proces topienia jest nieregularny, to znaczy ułatwiony jest przepływ gorącej wody i stopionej siarki w określonych, uprzywilejowanych kierunkach. W efekcie, kształt i rozmieszczenie oraz forma eksploatowanych części złoża są bardzo zmienne. Pełna informacja o złożu jest niezbędna do prawidłowego zrozumienia i przewidywania procesów zachodzących w złożu w czasie prowadzenia podziemnego wytapiania siarki, prognozowania jego skutków oraz sterowania przebiegiem eksploatacji. Uzyskuje się ją na podstawie opisu litologicznego próbek rdzeniowych z odwiertów, geofizycznej rejestracji w otworach wiertniczych oraz powierzchniowych badań sejsmicznych.

