

DOI 10.24425/aee.2022.140199

Maximization of injected power and efficiency based optimal location of DPFC using iterative procedure

SANTOSH KUMAR GUPTA¹✉, JAYANT MANI TRIPATHI², MRINAL RANJAN³,
RAVI KUMAR GUPTA⁴, DHEERAJ KUMAR⁵

¹*Sitamarhi Institute of Technology
Sitamarhi – 843301, Bihar, India*

²*Rajkiya Engineering College
Mainpuri – 205001, Uttar Pradesh, India*

³*Gaya College of Engineering
Gaya – 823003, Bihar, India*

⁴*Madan Mohan Malaviya University of Technology
Gorakhpur – 273008, Uttar Pradesh, India*

⁵*Shri Ramwaroop Memorial College of Engineering and Management
Lucknow, U.P, India*

e-mail: {✉santoshgupta1990/jayant023/mrinal10m255/ravikumareco/229007dk}@gmail.com

(Received: 13.05.2021, revised: 30.09.2021)

Abstract: Among the FACTS device, the distributed power flow controller (DPFC) is a superior device. This can be evaluated after eliminating the dc capacitor between shunt and series convertors of the unified power flow controller (UPFC) and placing a number of low rating single phase type distributed series convertors in the line instead of using single large rating three phase series convertors as in the UPFC. The power flow through this dc capacitor as in the UPFC now takes place through the transmission line at a third harmonic frequency in the DPFC. The DPFC uses the D-FACTS that allows the replacement of a large three-phase converter as in the UPFC by several small-size series convertors present in the DPFC. The redundancy of several series convertors increases the system's reliability of the power system. Also, there is no requirement for high voltage isolation as series convertors of the DPFC are hanging as well as single-phase types. Consequently, the DPFC system has a lower cost than the UPFC system. In this paper, the equivalent ABCD parameters of the latest FACTS device DPFC have been formulated with the help of an equivalent circuit model of the DPFC at the fundamental frequency component. Further, the optimal location in the transmission line and maximum efficiency of the DPFC along with Thyristor Controlled Series Compensator (TCSC), Static Synchronous Shunt Compensator (STATCOM) and



© 2022. The Author(s). This is an open-access article distributed under the terms of the Creative Commons Attribution-NonCommercial-NoDerivatives License (CC BY-NC-ND 4.0, <https://creativecommons.org/licenses/by-nc-nd/4.0/>), which permits use, distribution, and reproduction in any medium, provided that the Article is properly cited, the use is non-commercial, and no modifications or adaptations are made.

UPFC FACTS devices have been investigated using an iteration program developed in MATLAB under steady-state conditions. The results obtained depict that the DPFC when placed slightly off-center at 0.33 fraction distance from the sending end comes up with higher performance. Whereas, when the TCSC, STATCOM and UPFC are placed at 0.16, 0.2815, 0.32 fraction distances from sending end respectively give their best performance.

Key words: distributed power flow controller, efficiency, FACTS, maximum power transfer capability, optimal location

1. Introduction

The increase in consumption of electrical energy needs additional generating units as well as an extension of power system networks. However, this requires more investment and increases environmental issues. Generally, the load centers are far away from the power generating stations. The generating power is utilized by loads via power export-import schemes. The line impedances of lines decide the power flow in individual lines and there is no restriction of power flow to the preferred power corridors. Consequently, there is a chance of overloading of some lines with the overall effect of deteriorating voltage profiles and decreased system stability [1]. The cost and difficulties forbid the construction of new lines. There is therefore an urgent need to find means of utilizing the existing transmission facilities to a great extent. To enhance the transmissible power in AC power systems, it is a well-founded practice to utilize reactive power compensation. For enhancing the voltage profile as well as power flow in a transmission line fixed or mechanically switched capacitors and reactors are employed. It has been convincingly stated that both the transient and dynamic stability of the interconnected power system can be enhanced, and voltage disruption can be interrupted if the reactive power settlement of the transmission line is made speedily fluctuating with the help of the solid-state, thyristor switches, and electronic control. To control the voltage, power flow, and stability in a transmission line of a multi-area system a high current power electronics device is used that is known as the flexible AC transmission system (FACTS) [2]. The connection of various FACTS devices in a transmission line is described in different ways, such as in series connection, shunt connection, or a combination of series and shunt combination [3]. The FACTS devices, such as static synchronous series compensator (SSSC) and thyristor-controlled series capacitor (TCSC), are connected in series to the transmission lines to improve the power flow. To control the voltage profile of the transmission line by connecting in shunt the static VAR compensator (SVC) and static synchronous compensator (STATCOM) are used [4]. A flexible AC transmission system that is connected in combination of series and shunt to the transmission line to improve real and reactive power is the thyristor-controlled phase-shifting transformer (TCPST) and unified power flow controller (UPFC) [5]. The distributed FACTS was invented to reduce the cost and to increase the reliability of the system. In the distributed flexible AC transmission system device (D-FACTS) multiple low-power converters are connected to the transmission line by transformers consist of a single turn. The D-FACTS has several advantages in comparison to conventional FACTS devices, such as due to its lower cost it is easy to maintain the installation and enhance the system reliability because failure of one device will not shut down the entire system [6]. Presently, the distributed static series compensator (DSSC), which works as a D-FACTS device acts like a controlled variable conductor [7]. Due to the inability of

power sources in the DSSC, it can only control the line impedance and is not most as powerful as the UPFC [8,9].

Among all FACTS devices the DPFC is the latest device which has powerful capability to control the power flow in the transmission line because it has a large number of distributed series convertors and has no dc link between shunt and series convertors, like in the UPFC which provides high redundancy to the electrical system. Several works have been presented to find out the optimal placement of conventional FACTS devices like the TCSC, STATCOM and UPFC [24]. It is important to find out the optimal placement of the latest FACTS device DPFC.

This paper describes the optimal location of the distributed flexible AC transmission system in a transmission line under a steady state. To study the transmission line, a mathematical model is developed, in which it has been characterized by a two-port four-terminal model. The line and FACTS device parameters are represented by ABCD parameters. Finally, using the concept of ABCD parameters the exact optimal location of the TCSC, STATCOM, UPFC and DPFC have been evaluated with their maximum efficiency for a 500 KV system.

2. ABCD model of long transmission line

It is considered that the transmission network has four terminals, the distribution of the line parameters is uniform and there is two-port network modelling. Capacitors, resistors, and inductors are the main elements of any electrical system. In the transmission line, these three elements are uniformly present throughout the whole length. The line inductance has a very important role due to the facts that the inductive reactance of the line is directly proportional to the supply frequency and line inductance, and the inverse of this reactance is related to the power handling capability of the transmission line [10]. As the length of the transmission line increases, the line inductive reactance becomes high which results in lowering the power handling capabilities of the transmission line conductors [11]. Oppositely, the decrement in line reactance will increase the power handling capability of the transmission line. To decrease the value of inductive reactance a parallel inductive reactance circuit should be connected. To achieve this, the number of transmission lines should be increased which will increase the overall cost of the system. To solve these problems, the concept of FACTS devices was invented which can regulate the system parameters in dynamic as well as steady-state conditions. Several emerging issues like enhancement of system security, loss minimization, congestion management, and available transferability of the system and transmission pricing can be overcome using series-shunt compensating devices like the DPFC [12]. After removing dc capacitor from the UPFC and placing distributed series convertors, the DPFC can be evolved as shown Fig. 1 [13, 14].

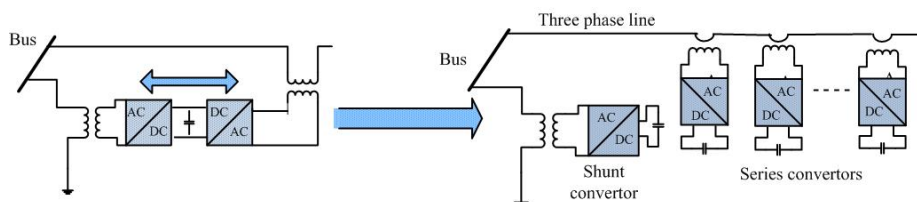

Fig. 1. Steps of growth of DFPC from the unified power flow controller [14]

There are certain locations of these FACTS devices at which benefits can be maximized [15]. Power angle, impedance and grid voltage are the parameters which affects the regulation of flow of power, and these are controlled by the DPFC controller simultaneously. When a FACTS device is configured as a series-shunt compensating device, it is located at a particular distance of x km from the sending end then a common general circuit constant of the regulated transmission line, having shunt reactance X_{sh} and series reactance X_{se} respectively is derived [16]. For a real interconnected transmission line containing impedance and admittance, depending upon the length of the line (short, medium, and long transmission line) the parameters can be represented in terms of ABCD parameters [17]. Once the line parameters are represented in terms of the ABCD parameter, a mathematical model can be developed easily for analyzing the circuit in various aspects required. A transmission system can be characterized by the two-port four-terminal system shown in Fig. 2.

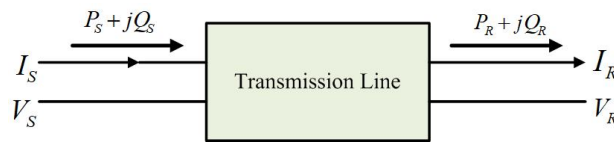

Fig. 2. Transmission system two port network [17]

The power in a transmission system flows from the sending end to the receiving end. In the case of a lossless transmission line, the sending end power should be equal to the receiving end power but in real practice due to the presence of admittance and impedance in the interconnected line, some energy is wasted in the transmission line [18]. If a system has Y mho/km admittance in a shunt, Z ohm/km impedance in series and L length of the transmission line, then the ABCD constant of the transmission network should be:

$$A = D = \cosh(\gamma L), \quad B = Z_c \sinh(\lambda L), \quad C = \sinh(\gamma L)/Z_c, \quad (1)$$

where the propagation constant is $\lambda = \sqrt{Z \cdot Y}$ and the characteristics impedance is $Z_c = \sqrt{\frac{Z}{Y}}$.

For convenience, all the four constants may be represented simultaneously in matrix form then,

$$\begin{bmatrix} A & B \\ C & D \end{bmatrix} = \begin{bmatrix} \cosh(\lambda L) & Z_c \cdot \sinh(\lambda L) \\ \frac{\sinh(\lambda L)}{Z_c} & \cosh(\lambda L) \end{bmatrix}. \quad (2)$$

Here all the ABCD parameters are in the polar quantities, so each of them has magnitude as well as an angle, $A = A \angle \theta_A$, $B = B \angle \theta_B$, $C = C \angle \theta_C$, $D = D \angle \theta_D$.

Then we simplified the model of the transmission line, by neglecting the resistance and capacitance. In that case the ABCD parameter constant of the transmission line model becomes:

$$A = D = 1 \angle 0^\circ, \quad B = x \cdot L \angle 90^\circ, \quad C = 0. \quad (3)$$

So, for a simplified model of the transmission line

$$\begin{bmatrix} A & B \\ C & D \end{bmatrix} = \begin{bmatrix} 1 & x \cdot L \angle 90^\circ \\ 0 & 1 \end{bmatrix}. \quad (4)$$

3. Efficiency of the line

From Fig. 2, sending end current I_S and voltage V_S can be expressed in terms of receiving end current I_R and voltage V_R as [23]:

$$V_S = AV_R + BI_R \quad \text{and} \quad I_S = CV_R + DI_R. \quad (5)$$

The sending end real and reactive power can be written as:

$$P_S = \frac{|A||V_S|^2}{|B|} \cos(\beta - \alpha) - \frac{|A||V_S||V_R|}{|B|} \cos(\beta - \delta + 180^\circ), \quad (6)$$

where δ is the power angle.

$$Q_S = \frac{|A||V_S|^2}{|B|} \sin(\beta - \alpha) - \frac{|A||V_S||V_R|}{|B|} \sin(\beta - \delta + 180^\circ). \quad (7)$$

The receiving end real and reactive power can be written as:

$$P_R = \frac{|V_S||V_R|}{|B|} \cos(\beta - \delta) - \frac{|A||V_R|^2}{|B|} \cos(\beta - \alpha), \quad (8)$$

$$Q_R = \frac{|V_S||V_R|}{|B|} \sin(\beta - \delta) - \frac{|A||V_R|^2}{|B|} \sin(\beta - \alpha). \quad (9)$$

The efficiency of the transmission line can be expressed as:

$$\eta = \frac{P_R}{P_S} \times 100\%. \quad (10)$$

4. ABCD model of transmission line with FACTS device

Theoretically, the FACTS device can be connected at any position between the generating end and the infinite bus. A general block diagram showing the FACTS device among sending end and receiving end is presented in Fig. 3.

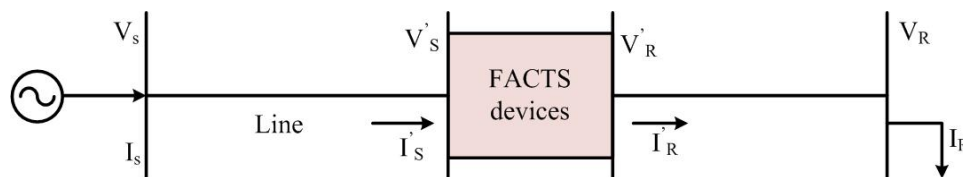

Fig. 3. General block diagram showing FACTS device in the transmission line [23]

The complete line can be divided into three parts, the line before the FACTS device towards the sending end, the FACTS device, and the line after the FACTS device towards the receiving

end [19]. The three parts are in cascading form as shown in Fig. 4, the overall ABCD parameters in such case are the multiplication of the ABCD constant of individual parts.

$$\begin{bmatrix} A & B \\ C & D \end{bmatrix} = \begin{bmatrix} A & B \\ C & D \end{bmatrix}_{L,x} \begin{bmatrix} A & B \\ C & D \end{bmatrix}_F \begin{bmatrix} A & B \\ C & D \end{bmatrix}_{L(1-x)} \quad (11)$$

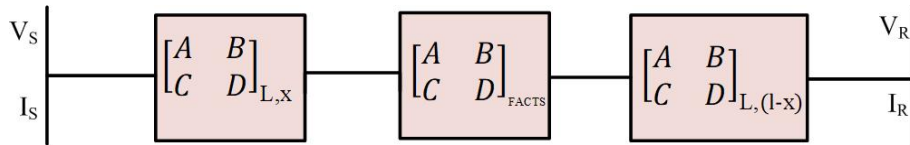

Fig. 4. Representation of ABCD parameters in cascading with FACTS device [23]

As shown in Fig. 4, if the FACTS devices are placed on a transmission line, then the sending end voltage and sending end current can be expressed by the equation:

$$\begin{bmatrix} V_S \\ I_S \end{bmatrix} = \begin{bmatrix} A & B \\ C & D \end{bmatrix}_{L,x} \begin{bmatrix} A & B \\ C & D \end{bmatrix}_F \begin{bmatrix} A & B \\ C & D \end{bmatrix}_{L(1-x)} \begin{bmatrix} V_R \\ I_R \end{bmatrix}, \quad (12)$$

$$\begin{bmatrix} V_S \\ I_S \end{bmatrix} = \begin{bmatrix} A & B \\ C & D \end{bmatrix} \begin{bmatrix} V_R \\ I_R \end{bmatrix}, \quad (13)$$

$$A = f(x), \quad B = f(x), \quad C = f(x), \quad D = f(x),$$

where $\forall x \in [0 \ 1]$.

5. ABCD constant model FACTS devices

5.1. ABCD model of TCSC

The TCSC is the FACTS device that can regulate the impedance of desire lines and quickly controls the power flow of that lines. It has a parallel combination of a fixed capacitor and a reactor controlled by a thyristor, as shown in Fig. 5(a).

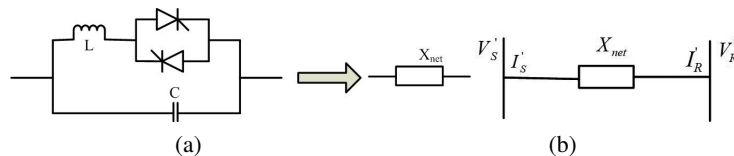

Fig. 5. Equivalent representation of TCSC (a); TCSC connected in the transmission line (b) [23]

The TCSC model consists of the offered variable reactance (both inductive and capacitive) X_{net} , which is dependent upon the firing angle of the thyristors and expressed as:

$$X_1 = \frac{\pi X_L}{2\pi - 2\alpha + \sin 2\alpha}, \quad (14)$$

where: α is the firing angle of the thyristor, X_L is the inductive reactance, X_1 is the variable reactance with the thyristor. Now X_1 and X_C are in parallel connection. So, in a steady state situation, X_{net} is represented as:

$$X_{\text{net}} = \frac{X_1 X_C}{X_C - X_1}. \quad (15)$$

For Fig. 5(b), the relationship between voltages and currents at the sending end and receiving end terminals in steady state conditions is written as:

$$V'_S = V'_R + jX_{\text{net}}I'_R \quad \text{and} \quad I'_S = I'_R. \quad (16)$$

From Eqs. (16) the ABCD parameters of the TCSC are obtained as [23]:

$$\begin{bmatrix} A & B \\ C & D \end{bmatrix}_{\text{TCSC}} = \begin{bmatrix} 1 & jX_{\text{net}} \\ 0 & 1 \end{bmatrix}. \quad (17)$$

5.2. ABCD model of STATCOM

The basic model of a STATCOM is depicted in Fig. 6(a). The reactive power generation and absorption is controlled by capacitor voltage. Based on the model of the STATCOM, the converter voltage V_{sh} is formulated as [23]:

$$V_{sh} = K_v E_{dc} \cos \frac{\beta_1}{2}, \quad (18)$$

where, E_{dc} is the terminal voltage of the capacitor, K_v is the coefficient for the multi-pulse waveform, β_1 is the firing angle of the thyristor of the converter.

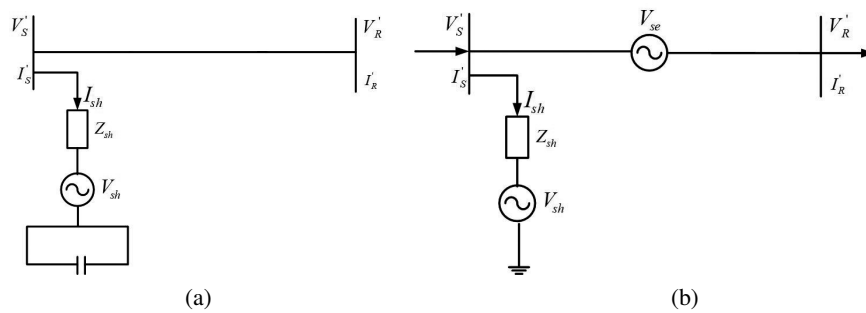

Fig. 6. Model of STATCOM (a); model of UPFC (b) [23]

At the operational point, K_1 is the operation parameter and from Fig. 6(a) we have the following:

$$K_v E_{dc} = K_1 V'_R \quad \text{and} \quad I'_S = I_{sh} + I'_R. \quad (19)$$

From Eqs. (18) and (19) the ABCD parameters of the ABCD are obtained as:

$$\begin{bmatrix} A & B \\ C & D \end{bmatrix}_{\text{STATCOM}} = \begin{bmatrix} 1 & 0 \\ K & 1 \end{bmatrix}, \quad (20)$$

where

$$K = 1 + \frac{1 - K_1 \cos \frac{\beta_1}{2}}{Z_{sh}}$$

and $K_1 = 1.1$, taken for the capacitive mode of operation.

5.3. ABCD model of UPFC

The UPFC model consists of two voltage sources as depicted in Fig. 6(b). One is connected in series with the line and other is connected in parallel with the line via a coupling transformer. In addition, both are linked via a dc capacitor. The model has a powerful capability to regulate system parameters like line impedance, power angle as well bus voltages resulting in powerful control over active and reactive powers. From the model of the UPFC it can be expressed as [23]:

$$V_{se} = \gamma e^{j\theta} V'_S \quad \text{and} \quad V'_S = C_P V'_R, \quad (21)$$

where

$$C_P = \frac{1}{1 + \lambda e^{j\theta}}, \quad \gamma = \frac{V_{se}}{V_S}$$

and θ varies from 0 to 2π radians.

$$I_{sh} = \frac{V'_S (1 - K_{sh})}{Z_{sh}}, \quad (22)$$

where

$$K_{sh} = \frac{V_{sh}}{V_S}$$

and from the basic principle of the UPFC we have the following:

$$\text{Re} [V'_S I'_{sh}] = \text{Re} [V_{se} I'^*_R]. \quad (23)$$

By solving the above three equations we get:

$$I'_S = \frac{C_P \cdot \text{Re} (1 - C_P) I'^*_R}{Z_{sh} C_P^2 \left(\frac{1}{Z_{sh}} \right)} + I'_R. \quad (24)$$

Or the above equation can be simplified as:

$$I'_S = K I'_R. \quad (25)$$

Therefore, the steady-state expression for this place of the UPFC will be

$$V'_S = C_P V'_R \quad \text{and} \quad I'_S = K I'_R. \quad (26)$$

In matrix form, the steady state equation taken from Eq (26) as follows:

$$\begin{bmatrix} V'_S \\ I'_S \end{bmatrix} = \begin{bmatrix} C_P & 0 \\ 0 & K \end{bmatrix} \begin{bmatrix} V'_R \\ I'_R \end{bmatrix}. \quad (27)$$

Therefore, the ABCD parameters for the UPFC are

$$\begin{bmatrix} A & B \\ C & D \end{bmatrix}_{\text{UPFC}} = \begin{bmatrix} C_P & 0 \\ 0 & K \end{bmatrix}. \quad (28)$$

5.4. Formulation of ABCD parameters of the DPFC

In the group of FACTS, the DPFC is a multipurpose device that can regulate real and reactive power. There are two voltage sources in the modelling of the DPFC. There are two converters in the DPFC. One is a single-turn transformer one connected in series with the transmission conductor and the other is connected in parallel with the transmission conductor [20]. Both the converters have a dc capacitor for storing energy. The injection of voltage with variable phases and magnitude into the line conductor is possible by the series converter [21]. The real power exchange occurs among the line conductor and series converter by the parallel converter [22]. The proposed model of the DPFC with the transmission system at fundamental frequency is shown in Fig. 7. The series converters of the UPFC and DPFC can be placed anywhere between two buses, whereas the shunt converter of UPFC can also be placed at anywhere in the line, but the shunt converter of the DPFC must be placed at the sending end of the line as shown in Fig. 8. This is the basic difference between mathematical calculations of the UPFC and DPFC, at the fundamental frequency component.

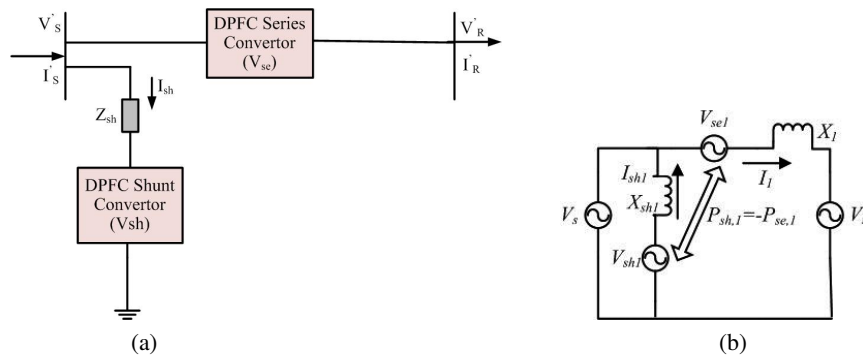

Fig. 7. DPFC circuit diagram with the transmission line (a); mathematical model of DPFC at fundamental frequency component (b)

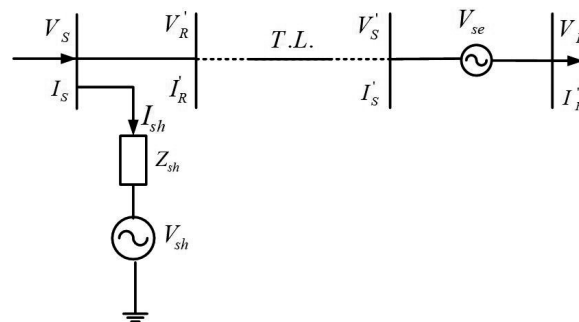

Fig. 8. Separation of series and shunt converters of the DPFC for the evaluation of ABCD parameters

From the above model of the DPFC, as the series and shunt converters of the DPFC are not together, it is necessary to evaluate the ABCD parameters of series and shunt converters separately.

From Fig. 8, the ABCD parameters of the shunt convertor of the DPFC can be calculated like the ABCD parameters calculated for the STATCOM from Eqs. (18) and (19).

$$\begin{bmatrix} V_S \\ I_S \end{bmatrix} = \begin{bmatrix} 1 & 0 \\ K_{SHUNT} & 1 \end{bmatrix} \begin{bmatrix} V'_R \\ I'_R \end{bmatrix}, \quad (29)$$

where

$$K_{SHUNT} = 1 + \frac{1 - K_1 \cos \frac{\beta_1}{2}}{Z_{sh}}$$

is the operating parameter for the DPFC, shunt convertor.

Therefore, the ABCD parameters of the shunt convertor of the DPFC which is placed at the sending end, are as follows:

$$\begin{bmatrix} A & B \\ C & D \end{bmatrix}_{DPFC_{SHUNT}} = \begin{bmatrix} 1 & 0 \\ K_{SHUNT} & 1 \end{bmatrix}. \quad (30)$$

From Fig. 8, the ABCD parameters of the series convertor of the DPFC can be calculated as:

$$V_{se} = \gamma e^{j\theta} V'_S \quad \text{and} \quad V'_S = C_P V''_R, \quad (31)$$

where

$$C_{P_{SERIES}} = \frac{1}{1 + \lambda e^{j\theta}}, \quad \gamma = \frac{V_{se}}{V_S}$$

and θ varies from 0 to 2π radians.

$$I'_S = I''_R. \quad (32)$$

From Eqs. (31) and (32) we get

$$\begin{bmatrix} V'_S \\ I'_S \end{bmatrix} = \begin{bmatrix} C_{P_{SERIES}} & 0 \\ 0 & 1 \end{bmatrix} \begin{bmatrix} V''_R \\ I''_R \end{bmatrix}. \quad (33)$$

Therefore, the ABCD parameters of the series convertor of the DPFC is given:

$$\begin{bmatrix} A & B \\ C & D \end{bmatrix}_{DPFC_{SERIES}} = \begin{bmatrix} C_{P_{SERIES}} & 0 \\ 0 & 1 \end{bmatrix}. \quad (34)$$

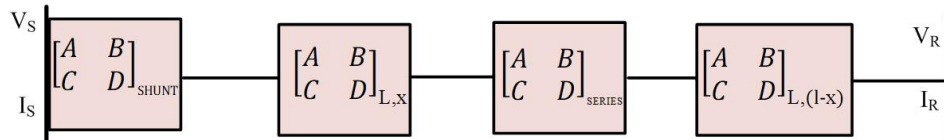

Fig. 9. Block representation of ABCD parameters in cascading with series and shunt convertors of the DPFC FACTS device

6. Results and discussion

To study the behaviour of different FACTS devices on the transmission line connecting a generating station with an infinite bus, a set of input data is required. In this work, a set of input data is used for analyzing the system provided in Table 1 [23]. The intersection points of the power received, and power delivered by the DPFC is important as this gives the optimal location of the DPFC on the transmission line as the power received and delivered by the FACTS devices at that point are equal. The exact locations of the TCSC, STATCOM, UPFC and DPFC are investigated with the help of an iteration program developed in MATLAB. Figure 10 and Fig. 11 are showing

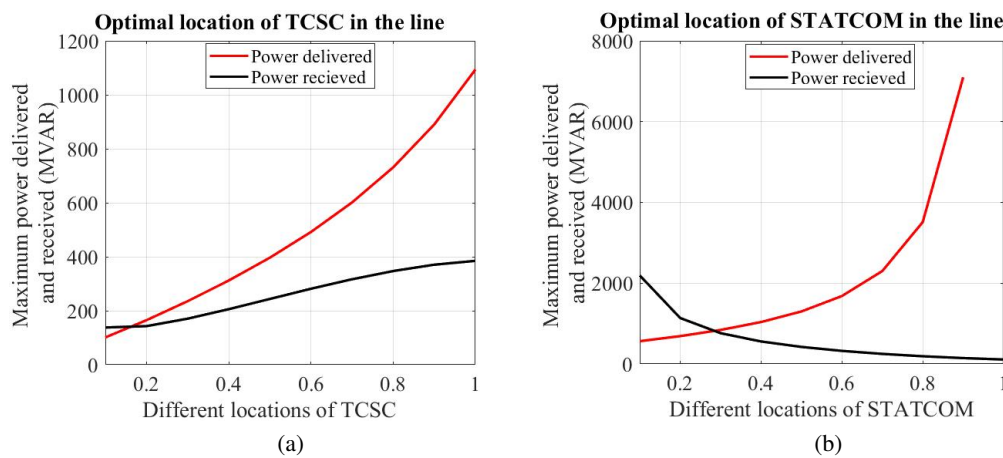

Fig. 10. Optimal location of TCSC in the transmission line (a); optimal location of STATCOM in the transmission line (b)

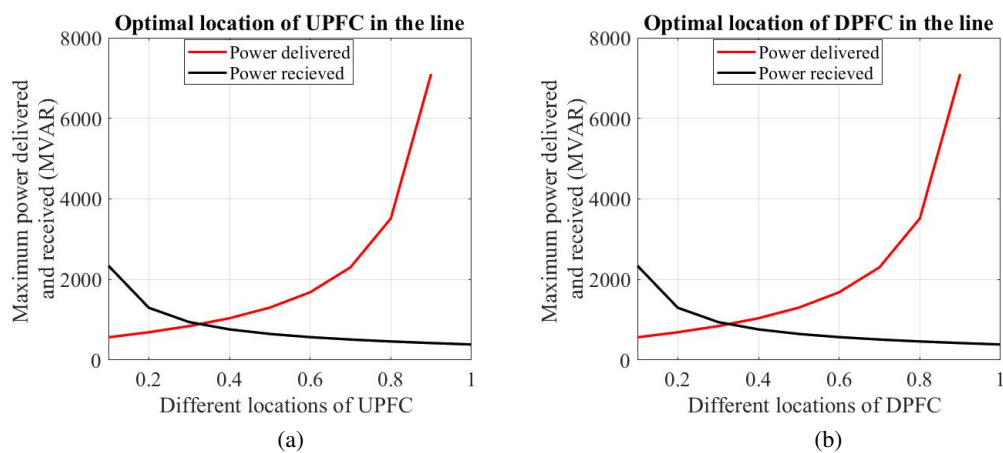

Fig. 11. Optimal location of UPFC in the transmission line (a); optimal location of DPFC in the transmission line (b)

how the TCSC, STATCOM, UPFC and DPFC receive and deliver power when it is placed at different locations.

Table 1. Set of input data used [23]

S. No.	Parameters	Data	Unit
1	Impedance of the line	$0.03808 + j0.7616$	ohm/km
2	Admittance of the line	$0.0 + j5.5$	$\mu\text{S/km}$
3	Length of the line	483 (300 miles)	km
4	Rating of the load	100	MVA
5	Receiving end voltage	500	kV
6	Power factor angle of the load	85	degree
7	Firing angle of the thyristor (α)	150 (for 60% compensation)	degree
8	γ (for series convertor)	0.01	–
9	θ (for series convertor)	90	degree

The optimal location of any FACTS device in the transmission line is that location where the power received and power delivered by that FACTS device are the same. At that point the system efficiency will be maximum. With the help of the iteration program developed in MATLAB, the optimal locations of the TCSC, STATCOM, UPFC and DPFC are investigated as: 0.16, 0.2815, 0.32 and 0.33 fractions of the transmission line from the sending end, respectively. These points are also found to be the same on the curves between power received and delivered by the FACTS devices and different locations of the FACTS devices in the transmission line as depicted from Fig. 10 and Fig. 11. As the power angle, line impedance and bus voltage magnitude control capabilities of the UPFC and DPFC are the same, the optimal location found for both are nearly equal.

By using the input given in Table 1 from [23], the optimal location of the TCSC, STATCOM, UPFC and DPFC in the line are found. With the help of the input data, variations of the received and delivered power by FACTS devices: the TCSC, STATCOM, UPFC and DPFC are obtained as in Table 2 when these devices are placed at different locations in the line.

Further calculations for the maximum efficiency of the power transfer on the bus have been done when the DPFC is placed at different locations. In this case, the calculation has been done for maximum efficiency when it is placed at 25 percent, 50 percent, and 75 percent from the generating (sending) end and exactly at the calculated optimal point. Figures 12–15 are showing the efficiency of the power delivered from the sending end to the receiving end vs the fraction of MVAR transferred for the TCSC, STATCOM, UPFC and DPFC, respectively. It is observed that maximum efficiency found is 93.221% corresponding to 50% MVAR transferred for the TCSC placed at the optimal location, 90.31% corresponding to 50% MVAR transferred for the STATCOM placed at the optimal location, 91.58% corresponding to 50% MVAR transferred for the UPFC placed at the optimal location and 92.101% corresponding to 50% MVAR transferred for the DPFC placed at the optimal place.

Table 2. Optimum locations of FACTS devices to deliver maximum power

Fractional length of line X	Power received by TCSC (MVAR)	Power delivered by TCSC (MVAR)	Power received by STATCOM (MVAR)	Power delivered by STATCOM (MVAR)	Power received by UPFC (MVAR)	Power delivered by UPFC (MVAR)	Power received by DPFC (MVAR)	Power delivered by DPFC (MVAR)
0.1	137.9	101	2190.4	563.5	2340.5	565.2	2341.1	565.3
0.2	143	165	1136.8	688.8	1296.4	690.2	1297.7	690.4
0.3	170.6	235	761.2	841.9	943	842.9	943.4	843.4
0.4	205.7	312	556.2	1037	761	1037.9	761.4	1039
0.5	243.7	397	421.2	1300	647.8	1300.9	648.2	1302
0.6	281.5	492	323.2	1682	568.7	1682.8	569.3	1683
0.7	316.7	601	248.5	2300	509	2301.6	509.8	2302
0.8	347.2	731	190.4	3513	461.8	3514	462.3	3515
0.9	370.6	890	144.9	7098	422.1	7101.9	422.4	7102

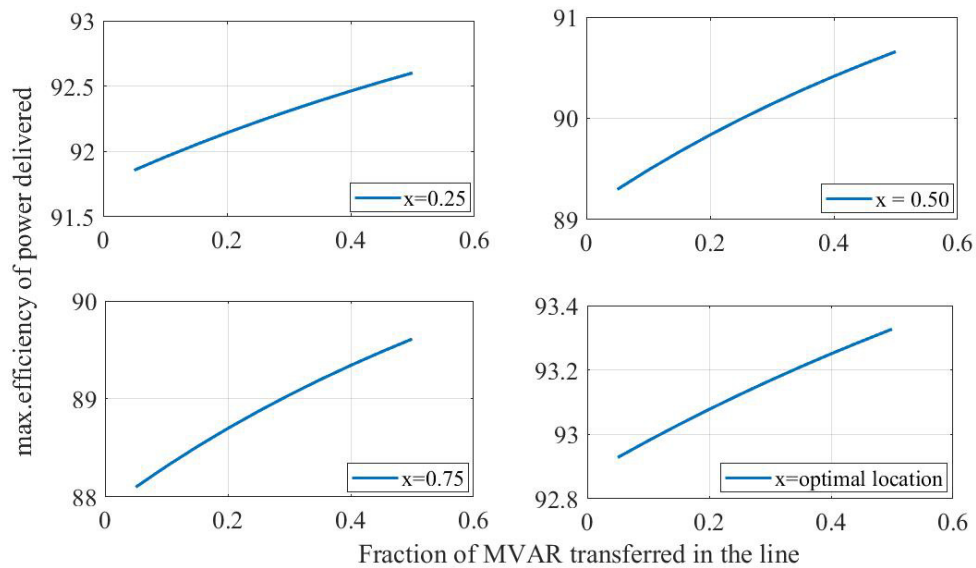

Fig. 12. Line maximum efficiency with different locations of TCSC

Figure 16 and Fig. 17 give maximum efficiency variations with fractional power for different fraction locations of the DPFC. The different fraction of load as well as load power factor of two different parameters has been plotted to find the maximum efficiency by keeping one parameter

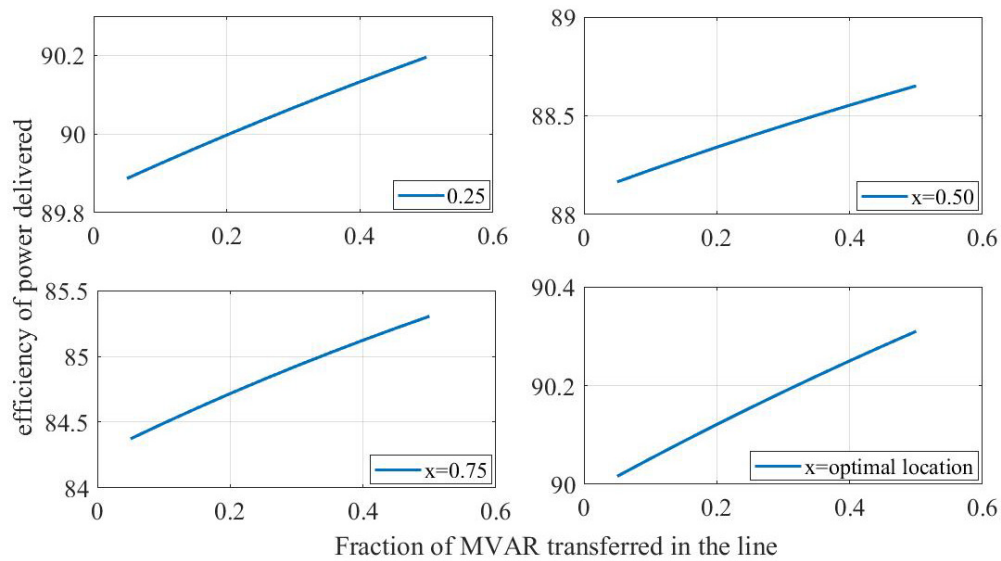

Fig. 13. Line maximum efficiency with different locations of STATCOM

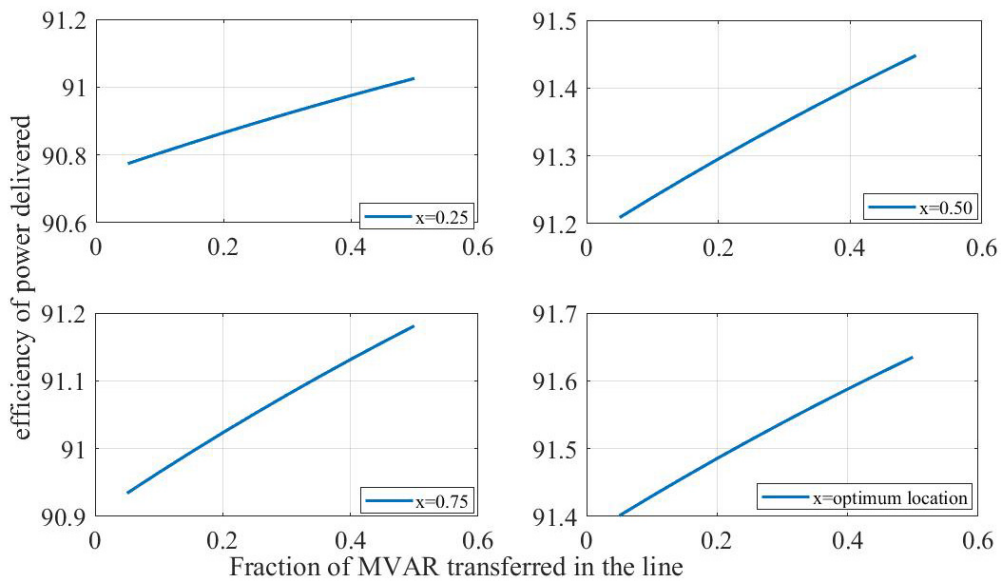

Fig. 14. Line maximum efficiency with different locations of UPFC

constant at a time. The left graph in Fig. 16 shows the variation of efficiency vs load power factor with constant load applied at the receiving end bus for the UPFC while the right graph in Fig. 16 shows the variation of maximum efficiency vs load with constant power factor for the UPFC.

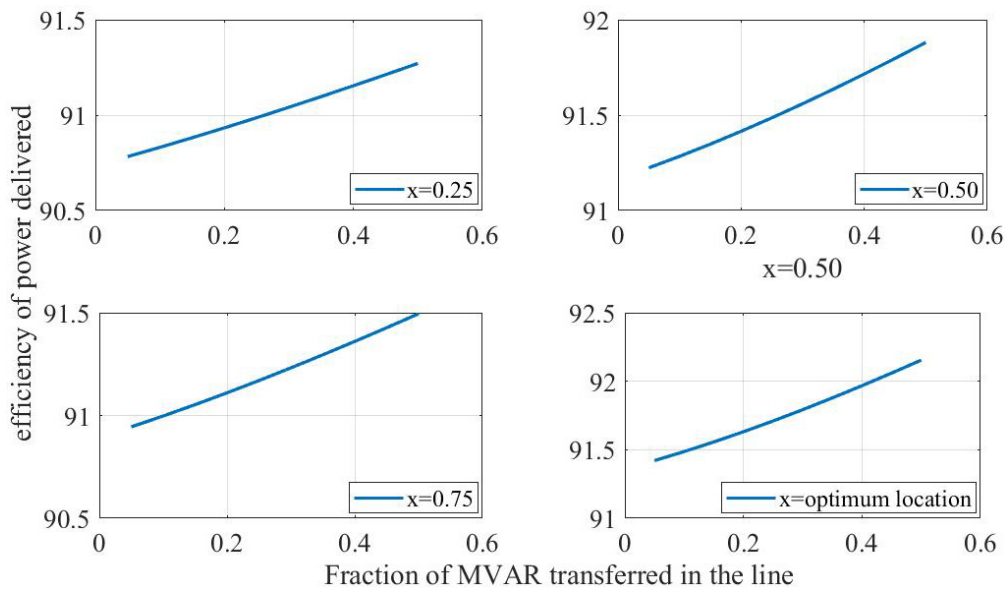

Fig. 15. Line maximum efficiency with different locations of DPFC

Similarly, the left graph in Fig. 17 shows the variation of maximum efficiency vs load power factor with constant load applied at the receiving end bus for the DPFC, while the right graph in Fig. 17 shows the variation of maximum efficiency vs load with constant power factor.

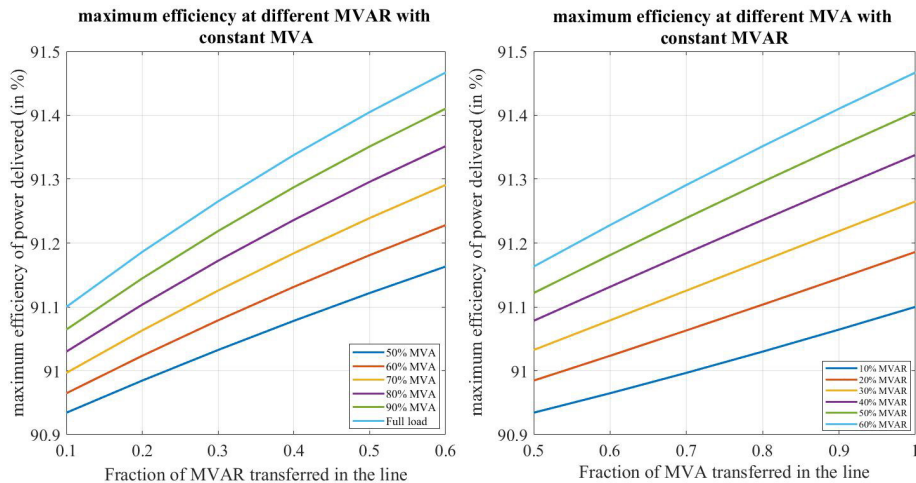

Fig. 16. Maximum efficiency of the system at different MVAR transferred with constant MVA and different MVA transferred with constant MVAR for UPFC

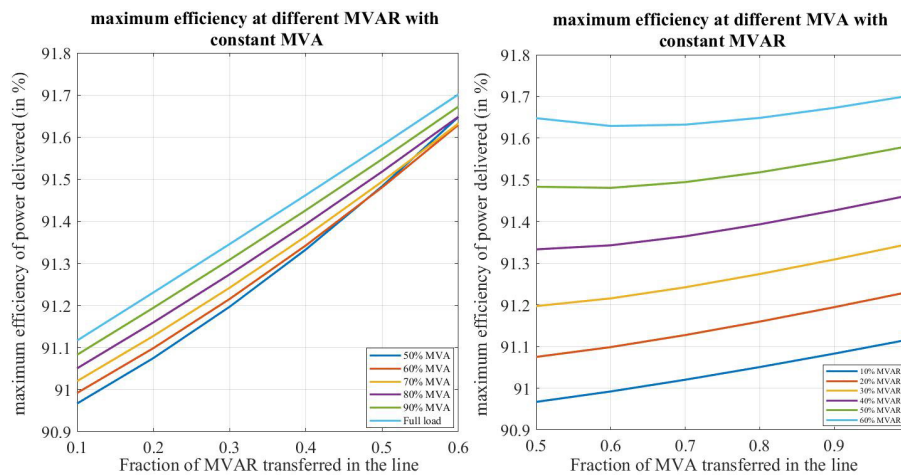

Fig. 17. Maximum efficiency of the system at different MVAR transferred with constant MVA and different MVA transferred with constant MVAR for DPFC

7. Conclusions

The paper presents a study of the performance of the transmission line by connecting the DPFC and other series as well as shunt FACTS device in a long transmission line with a generating end and an infinite bus. The programs developed in MATLAB depict apparent power and reactive power change in line with the change in the position of FACTS devices. The ABCD parameters of the DPFC have been developed by evaluating a DPFC model at the fundamental component, and implemented in the long transmission line. The optimal location of the DPFC on a 483 km transmission line has been investigated with the help of an iterative program developed in MATLAB under steady-state conditions. It is observed that for the selected set of inputs the optimal position of the DPFC in a transmission system is at 0.33 fraction of the line from the sending end. For the purpose of a comparative analysis, the optimal locations of other FACTS devices the TCSC, STATCOM and UPFC have been investigated in the same manner as investigated in the case of the DPFC. For the same input parameters, the optimal locations of the TCSC, STATCOM and UPFC are found to be of 0.16, 0.2815 and 0.32 fractions of the line from the sending end respectively. It is observed that the obtained optimal location of the UPFC and DPFC are nearly same, it is due to the same power control capabilities of both devices. This helps in finding the optimal location of the DPFC for maximum power transferred and efficiency.

References

[1] Edris A.A., Aapa R., Baker M.H., Bohman L., Clark K., *Proposed terms and definitions for flexible ac transmission system (FACTS)*, IEEE Trans. on Power Delivery, vol. 12, no. 4, pp. 1848–1853 (1997), DOI: [10.1109/61.634216](https://doi.org/10.1109/61.634216).

[2] Das D., Divan D.M., Harley R.G., *Power flow control in networks using controllable network transformers*, IEEE Trans. Power Electron., vol. 25, no. 7, pp. 1753–1760 (2010), DOI: [10.1109/TPEL.2010.2042076](https://doi.org/10.1109/TPEL.2010.2042076).

- [3] Ooi B.T., Kazerrani M., Marcean R., Wolanski Z., Galiana F.D., Megillis D., Jms G., *Midpoint siting of FACTS devices in transmission lines*, IEEE Trans. on power delivery, vol. 12, no. 4, pp. 1717–1722 (1997), DOI: [10.1109/61.634196](https://doi.org/10.1109/61.634196).
- [4] Hingorani N.G., Gyugyi L., *Understanding FACTS: Concepts and Technology of Flexible AC Transmission Systems*, New York: IEEE Press (2000).
- [5] Nabavi-Niak A., Irvani M.R., *Steady-State and Dynamic Models of Unified Power Flow Controller (UPFC) for Power System Studies*, IEEE Trans. Power Systems, vol. 11, no. 4 (1996), DOI: [10.1109/59.544667](https://doi.org/10.1109/59.544667).
- [6] Harjeet Johal, Deepak Divan, *Design Considerations for Series-Connected Distributed FACTS Converters*, IEEE Transactions on Industry Applications, vol. 43, iss. 6, pp. 1609–1618 (2007), DOI: [10.1109/TIA.2007.908174](https://doi.org/10.1109/TIA.2007.908174).
- [7] Amir Hamidi, Sajjad Golshannavaz, Daryoush Nazarpour, *D-FACTS Cooperation in Renewable Integrated Microgrid A Linear Multiobjective Approach*, IEEE Transactions on Sustainable Energy, vol. 10, iss. 1, pp. 355–363 (2019), DOI: [10.1109/TSTE.2017.2723163](https://doi.org/10.1109/TSTE.2017.2723163).
- [8] Narasimha Rao D., Srinivasa Varma P., *Comparison of UPFC and DPFC*, Journal of Critical Reviews, vol. 7, iss. 6 (2020), DOI: [10.31838/jcr.07.06.153](https://doi.org/10.31838/jcr.07.06.153).
- [9] Abhilash Sen, Atanu Banerjee, Haricharan Nannam, *A Comparative Analysis between UPFC and DPFC in a Grid Connected Photovoltaic System*, IEEE International Conference on Intelligent Techniques in Control, Optimization and Signal Processing (INCOS) (2019), DOI: [10.1109/IN-COS45849.2019.8951352](https://doi.org/10.1109/IN-COS45849.2019.8951352).
- [10] Song W., Zhou X., Zhigang Liang, Subhashish Bhattacharya, Huang Alex Q., *Modeling and Control Design of Distributed Power Flow Controller based-on Per-phase control*, IEEE Energy Conversion Congress and Exposition (2009), DOI: [10.1109/ECCE.2009.5316307](https://doi.org/10.1109/ECCE.2009.5316307).
- [11] Chandrakar V.K., Kothari A.G., *Optimal Location for Line Compensation by Shunt Connected FACTS Controller*, IEEE Power Electronics and Drive Systems Conference, vol. 1, pp. 151–156 (2003), DOI: [10.1109/PEDS.2003.1282736](https://doi.org/10.1109/PEDS.2003.1282736).
- [12] Vikash Anand, Sanjeev Kumar Mallik, *Power flow analysis and control of distributed FACTS devices in power system*, Archives of Electrical Engineering, vol. 67, no. 3, pp. 545–561 (2018), DOI: [10.24425/123662](https://doi.org/10.24425/123662).
- [13] Zhihui Yuan, de Haan Sjoerd W.H., Ferreira Jan A., *Construction and first result of a scaled transmission system with the Distributed Power Flow Controller (DPFC)*, 13th European Conference on Power Electronics and Applications (2009).
- [14] Zhihui Yuan, de Haan Sjoerd W.H., Braham Frreira, Dalibor Cevoric, *A FACTS Device: Distributed Power Flow Controller (DPFC)*, IEEE Trans. Power Electronics, vol. 25, no. 10 (2010), DOI: [10.1109/TPEL.2010.2050494](https://doi.org/10.1109/TPEL.2010.2050494).
- [15] Syona Chawla, Sheetal Garg, Bhawna Ahuja, *Optimal Location of Series-Shunt FACTS Device for Transmission Line Compensation*, IEEE Control, Automation, Communication and Energy Conservation Conference, pp. 1–6 (2009).
- [16] Shehata Ahmed A., Refaat Ahmed, Mamdouh K. Ahmed, Korovkin Nikolay V., *Optimal placement and sizing of FACTS devices based on Autonomous Groups Particle Swarm Optimization technique*, AEE, vol. 70, no. 1, pp. 161–172 (2021), DOI: [10.24425/aee.2021.136059](https://doi.org/10.24425/aee.2021.136059).
- [17] Riadh Essaadali, Anwar Jarndal, Ammar B. Kouki, Fadhel M. Ghannouch, *Conversion Rules Between X-Parameters and Linearized Two-Port Network Parameters for Large-Signal Operating Conditions*, IEEE Transactions on Microwave Theory and Techniques, vol. 66, no. 11, pp. 4745–4756 (2018), DOI: [10.1109/TMTT.2018.2863227](https://doi.org/10.1109/TMTT.2018.2863227).

- [18] Divya S., Shyamala U., *Power quality improvement in transmission systems using DPFC*, IEEE 2nd International Conference on Electronics and Communication Systems (ICECS) (2015), DOI: [10.1109/ECS.2015.7125035](https://doi.org/10.1109/ECS.2015.7125035).
- [19] Apolinar Reynoso-Hernández J., Pulido-Gaytán M.A., Cuesta R., Loo-Yau J.R., Maya-Sánchez M.C., *Transmission Line Impedance Characterization Using an Uncalibrated Vector Network Analyzer*, IEEE Microwave and Wireless Components Letters, vol. 30, no. 5, pp. 528–530 (2020), DOI: [10.1109/LMWC.2020.2984377](https://doi.org/10.1109/LMWC.2020.2984377).
- [20] Monika Sharma, Annapurna Bhargava, Pinky Yadav, *Oscillation Damping with DPFC Using Optimization Techniques*, IEEE International Conference on Micro-Electronics and Telecommunication Engineering (ICMETE) (2017), DOI: [10.1109/ICMETE.2016.73](https://doi.org/10.1109/ICMETE.2016.73).
- [21] Mengmeng Xiao, Shaorong Wang, Yong Huang, Chao Zheng, Qiushi Xu, Hongsheng Zhao, Aihong Tang, Dichen Liu, *Two-Level Control Method for DPFC Series Units Based on PLC Communication*, 2nd IEEE Conference on Energy Internet and Energy System Integration (EI2), pp. 20–22 (2018), DOI: [10.1109/EI2.2018.8582109](https://doi.org/10.1109/EI2.2018.8582109).
- [22] Zhai X., Tang A., Zou X., Xu Zheng, Qiushi Xu, *Research on DPFC Capacity and Parameter Design Method*, IEEE International Conference on Information Technology, Big Data and Artificial Intelligence (ICIBA) (2020), DOI: [10.1109/ICIBA50161.2020.9277315](https://doi.org/10.1109/ICIBA50161.2020.9277315).
- [23] Pradhan A.K., Routray A., Banaja Mohanty, *Maximum efficiency of flexible AC transmission systems*, Electrical Power and Energy Systems, vol. 28, pp. 581–588 (2006), DOI: [10.1016/j.ijepes.2006.03.014](https://doi.org/10.1016/j.ijepes.2006.03.014).
- [24] Seyed Abbas Taher, Muhammad Karim Amooshahi, *New approach for optimal UPFC placement using hybrid immune algorithm in electric power systems*, International Journal of Electrical Power and Energy Systems, vol. 43, iss. 1, pp. 899–909 (2012), DOI: [10.1016/j.ijepes.2012.05.064](https://doi.org/10.1016/j.ijepes.2012.05.064).