

New Construction Methods and Performance Analysis of WINDMI Chaotic System

Thair A. Salih

Abstract—Chaos is an active topic of study in the field of secure communication systems that have garnered much consideration in recent years because of excessive sensitivity to a simple change in its initial conditions. In this paper, the essential features of the suggested WINDMI chaotic system like the phase portraits of the attractors, bifurcation, PSD, correlation, and balance property of the windmi chaotic system have been depicted in detail through MATLAB tools simulations and circuital application. The bifurcation examination detects a wealthy and attractive characteristic of the proposed windmi chaotic oscillator such as periodical multiple bifurcations, has two stable states chaotic demeanor, periodical windows, and recapture bifurcations. In this paper, after exploring the dynamic features of the windmi chaos paradigm, a practical chaotic circuit is implemented on the fpaac chip. Eventually, the circuit practical results of the windmi chaotic attractors present similarities with numerical simulations. The importance of the work is reflected in the use of field programmable analog array in the implementation of the windmi oscillator, and the possibility of varying the initial condition during the operation of the system. An unlimited number of signals can be generated, which enables it to be used as an oscillator utilized in many transceiver systems, that utilized an unlimited number of signals.

Keywords—chaotic signal; fpaac; bifurcation; psd; correlation

I. INTRODUCTION

DUE to the dramatic ingrowth in transmissions of multimedia information over risky channels (mostly the Internet), safety must turn to every requested region of research. To keep information from snoop and prohibited users, many researchers have buckled down to evolve new encryption algorithms [1]. By looking at its elevated pseudorandom, chaotic encryption is seen as one of the ultimately committed styles for physical-layer secure transportation. Chaos encryption has an elevation sensitivity to the initial value and therefore it has a great area for application [2]. The chaotic demeanor of effective systems can be applied in numerous realism implementations, for example, but not limited to oscillators [3], physics [4], random bit generators [5], Plasma systems [6], Tokamak chaotic systems [7], biomedical and medical applications [8], secure communications [9], optoelectronic devices [10], memristors [11]. The chaos-based communication systems have appealed a large interest, start with Shannon's 1947 admission that a noise-like signal with a waveform of maximal entropy produced an optimization wireless communications channel capacity [12]. Numerous novel chaotic systems that offer various dynamical actions have possessed a place in literature [10, 13-21]. Wireless chaotic communication has many

features other than the systems dependent on a classical harmonic signal, viz enormous safety and hide information advantages [22], weak power spectrum intensity, resistance to multipath fading, is simply implemented for broadband communication system [23], and sensitivity to initial conditions [8,24-27]. Pecora and Carroll described that Chaotic systems can to synchronization and can be implemented utilized electronic circuits [28].

II. RELATED WORKS

Many chaotic communication systems were proposed to focus on this type of secure communication for information transmissions such as chaotic masking [29], Lorenz system [30], Chen system [31], Three-Scroll Unified Chaotic System [32], Lorenz-like system[33], Dadar's system [34], Liu-Chen system [35], and Chen-Cheng system [33]. Scientists and researchers have grown more interested in chaotic communication systems because of the wide bandwidth that they enjoy compared to traditional systems with narrow bandwidth which is loaded with a large amount of data [36]. S. Vaidyanathan (2015) suggested a controlled backstepping adaptation design for the anti-synchronization of similar third-order chaotic systems with undefined factors. For that reason, a WINDMI system was chosen. Lyapunov stabilization theory is used to implement the suggested controller design. The simulation results, with MATLAB, showed the efficiency of the adaptive anti-synchronization controller in the situation of conformable chaotic modules [37]. Baogui Xin, et al. [2010] present a study for chaotic synchronization of WINDMI's chaotic partial master-slave compatibility systems through the use of linear state error feedback control techniques. According to the stability theory of nonlinear fractional arrangement systems, the law of linear feedback control for chaotic synchronization has been inspected. A numerical simulation was performed to prove the performance of the suggested synchronization system[38]. Suresh and Sundarapandian applied the backstepping control method to guess the fixed anonymous factor and realize universal chaos synchronization for WINDMI and Couillet chaotic systems. As the Lyapunov exponents are not wanted for these computations, the adaptive backstepping control design is so efficient and suitable to realize cosmopolitan chaos synchronization. Numerical simulations have been done to clarify and investigate the effectiveness of the adaptive backstepping control-based synchronization schemes of the WINDMI and Couillet chaotic systems [39]. S. Vaidyanathan's obtained good results for the adaptive backstepping controller design for the anti-synchronization of similar WINDMI systems (Wind-Magnetosphere-Ionosphere models) with undefined factors and also specifics of carrying out SPICE of the suggested adaptive backstepping controller. In the anti-

Thair A. Salih is with Northern Technical University, Iraq (e-mail: thairali59@ntu.edu.iq).



synchronization of chaotic systems, the aggregate of the outputs of master and slave systems is performed to concentrate near to zero with time. The adaptive control design for the anti-synchronization of symmetrical WINDMI systems with undefined factors has been created by utilized Lyapunov stability theory. MATLAB simulations have been displayed for the clarification of the adaptive anti-synchronizing backstepping controller for symmetrical WINDMI chaotic systems. Finally, the suggested controller has been an executive using SPICE, and circuit simulation outcomes have been detailed [40]. J. Wang, et al. addressed the problem of the time delay between the sending and receiving signals, through the chaotic synchronization of the WINDMI system which depends on Lyapunov stability theory and matrix weighing processes, so that the slave system case at time t is convergent synchronization with the factor at time $t-\tau$. mathematical software is applied to the evidence of the influence of this manner[41]. This paper is regulated as follows: In Section 2, the objectives of the proposed research are presenters. In Section 3, an electronic circuit of the WINDMI chaotic system is displayed based on FPAA technology to prove the applicability of the Windme Chaotic system in practice and compare it with the theoretical basis model. Section 4 concludes this work with an outline of the major results.

III. OBJECTIVES

Most chaotic sequences are fundamentally derived from single chaotic maps. These chaotic sequences are easy to realize. The defects of these chaotic systems sequence appeared gradually through the ease of cracking the sequences of these systems, so the focus became on the systems that can resist this crack. In this research, MATLAB simulations are approved software is adopted to clarify the attractor of the WINDMI chaotic system, dynamics of the bifurcation diagram, and initial value sensitivity which is a paramount feature. Lastly, FPAA technology was used to investigate WINDMI chaotic system to emphasize the feasibility of the theoretical model.

IV. SYSTEM MODEL

Originally, in 1998, Horton and Doxas suggested the WINDMI system [42]. Smith et al., explorer the effective area of the WINDMI system [43]. WINDMI system can appreciate remoteness factor rates for planets with magnetospheres. In detail, there is present partial instability of collision fewer ripping styles, and kinetic ballooning styles, WINDMI system can be used as an outer framework for these styles[39]. WINDMI technique is the Wind-Magnetosphere-Ionosphere system which represents the energy influx from the solar wind-magnetosphere-ionosphere system [37]. Sprott was the first one which simplified the mathematical model WINDMI chaotic system as follows [46]:

$$\dot{y}_1 = y_2, \quad (1)$$

$$\dot{y}_2 = y_3, \quad (2)$$

$$\dot{y}_3 = -a \cdot y_3 - y_2 + b - e^{y_1} \quad (3)$$

where y_1 , y_2 , and y_3 are variables and a , b are positive constants.

V. SIMULATION PARAMETERS OF WINDMI CHAOTIC SYSTEM

WINDMI system signal has chaotic behaviour represented by a group of continuous curves with a recurring geometric pattern and there is no specific way to characterize this model because it represents a three-dimensional shape and not a flat shape. There are two important parameters in determining the chaotic signal specifications, which are the initial conditions, whose values are chosen so that the conditional factors of the Lyapunov function will be achieved and thus will we guarantee that the initial values of the chaotic convergence signal will diverge quickly and Bifurcation parameter.

A. Phase Portraits

MATLAB program is used for the numerical simulation of the WINDMI system determined by differential equations 1, 2, and 3. The attractor is a helpful process to test the system's common attractions, which change with the initial values. Fig. 1 shows fore castings of the hidden attractor of the 2-D and 3-D WINDMI chaotic system with given initial conditions $a=0.7$, $b=3.5$. Figures 1(a)-(c) display the estimation of the fore castings of the unknown attractor of WINDMI chaotic system (the $x-z$ plane, the $y-z$ plane, and $x-y$) successively. Figure 1-d presents the 3-D phase portrait of the attractor.

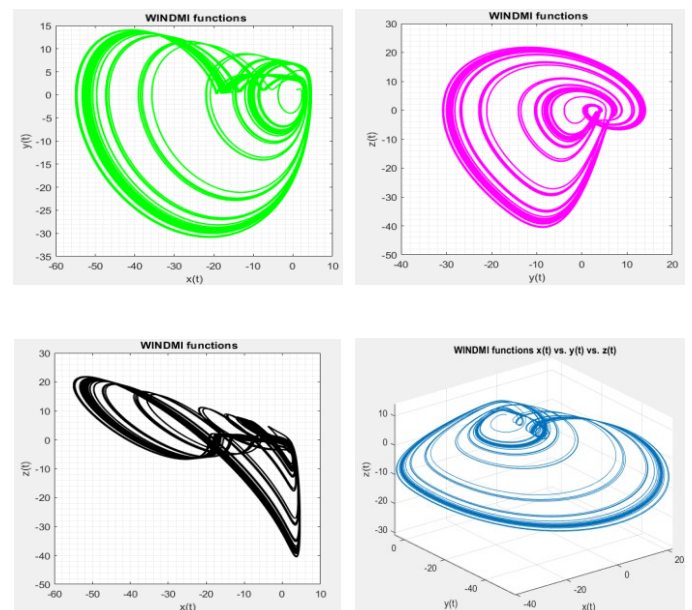

Fig. 1. Numerical Simulation Outcomes , for $a = 0.7$ and $b = 3.5$, in (a) $x-y$ Plane, (b) $y-z$ Plane, (c) $x-z$ Plane and (d) $x-y-z$ Plane.

B. Auto-correlation and cross-correlation

The auto-correlation mission is an arithmetic gadget for revealing iterating models in a signal, like periodic models that are concealed by noise. It is utilized to estimate the random impression of sequences. The WINDMI chaotic sequence was created using MATLAB and the simulation was achieved on the Simulink tool see Figure 3. The auto-correlation mission is an arithmetic gadget for revealing iterating models in a signal, like periodic models that are concealed by noise. It is utilized to estimate the random impression of sequences.

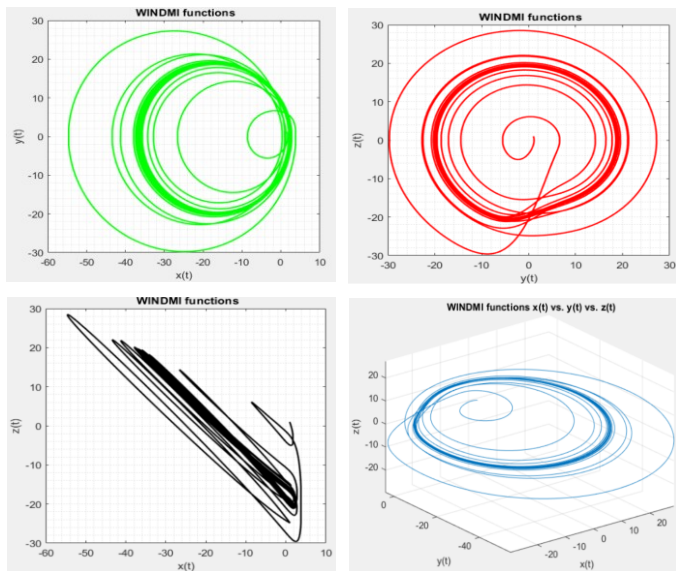

Fig.2. Numerical Simulation Outcomes, for a = 0.1 and b = 1, in (a) x-y Plane, (b) y-z Plane, (c) x-z Plane and (d) x-y-z Plan

The auto-correlation mission of the WINDMI chaotic signal produced is displayed in Figure 4. It is obvious that the WINDMI chaotic has a perfect autocorrelation function shape. The cross-correlation feature is as significant in communication devices as the autocorrelation feature. Cross-correlation is an indication of compatibility distinct between the two various codes. A high amount of cross-correlation is unwanted in secure communications systems. Figure 5 displays the cross-correlation of the WINDMI chaotic system. It is found that the cross-correlation is near to zero but does not reach zero. The excellent cross-correlation efficiently would help in overall communication system behavior because of noise reduction. The cross-correlation feature is useful for CDMA applications, as the receiver can distinguish between the spread spectrum signals created by different chaotic sequences.

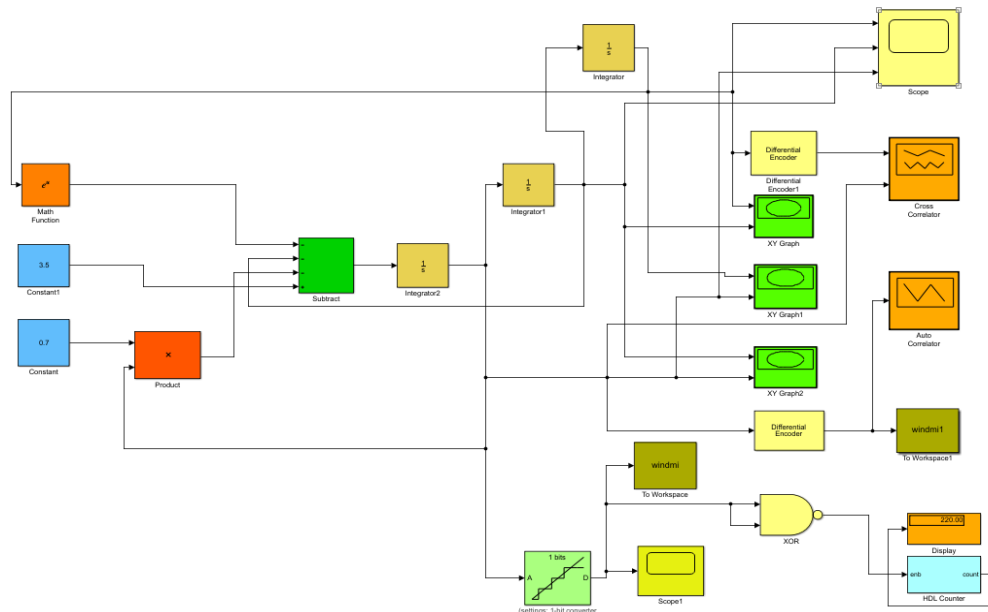

Fig. 3 MATLAB-SIMULINK Model for Windmi chaotic system

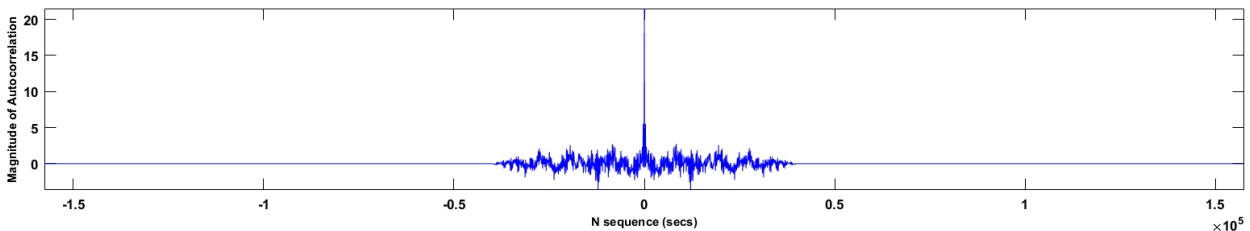

Fig. 4 Autocorrelation Property

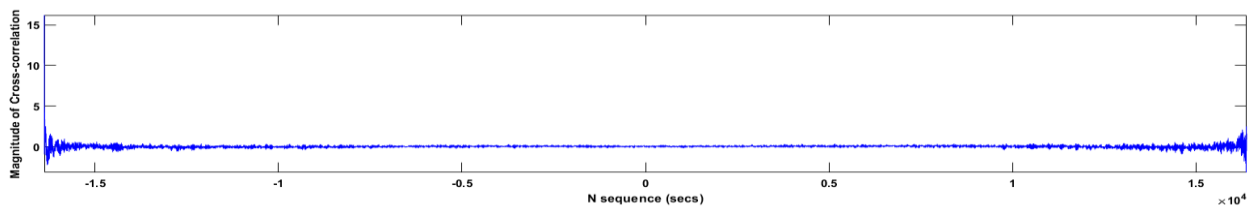

Fig. 5 Cross-Correlation Property

C. Balance property

Balanced property is a beneficial test for chaotic sequences utilized insecure communication systems. The simulation outcome is displayed in Figure 6. Sequences with length $N = 1000$ were produced the mean of differences is 0.4725 and the standard variance is 0.2558 which marks that the sequences created have superior balance behavior.

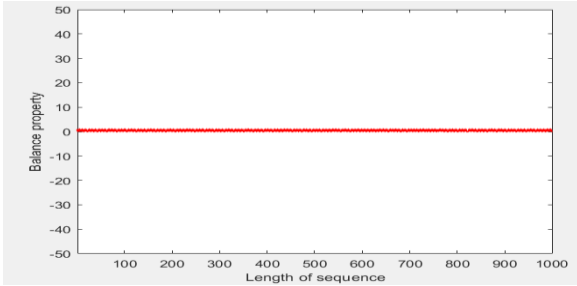

Fig. 6 Balance Property

D. Initial Condition

WINDMI chaotic system is extremely susceptible to initial conditions, and for this reason, it is very difficult to prophesy the path of the system. Small variation through the initial values of the chaotic map can lead to the important variation of the sequences with the growing iteration times. Figure 7 displays WINDMI chaotic $x(t), y(t)$ and $z(t)$ output signals for the initial values $a=0.7$ and $b=3.5$, while Figure 8 displays the $x(t), y(t)$ and $z(t)$ output signal for initial values $a=0.1, b=1$ after iterating sever times the variance has become clear. It can be said that the WINDMI chaotic system is easy to build, in addition to the possibility of obtaining an infinite number of the output signal by changing the most crucial parameters a and b which affects not only the amplitude but also the frequency and shape of the output signal.

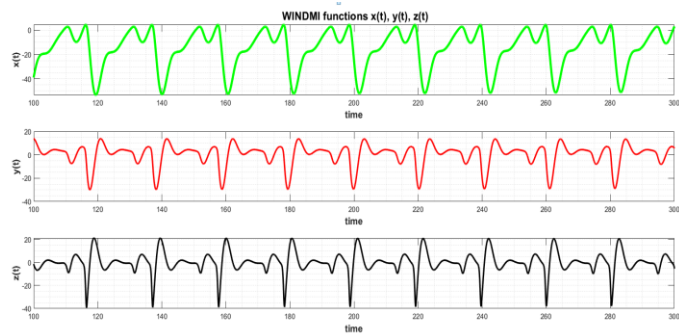

Fig.7. Time Series at $a = 0.7$ and $b = 3.5$

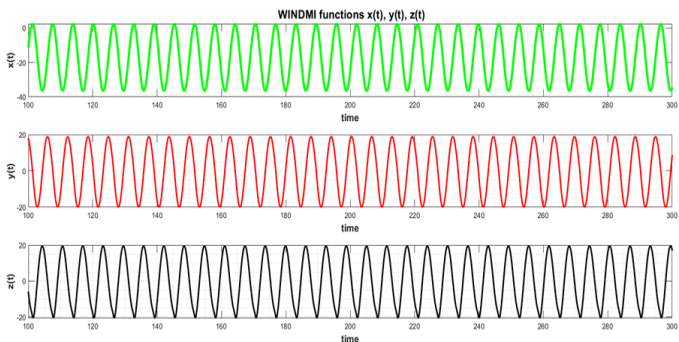

Fig. 8. Time Series at $a = 0.1$ and $b = 1$.

E. Bifurcation Property

The bifurcation of a dynamical system as an arbitrary variable in its actives is obtained by changing a parameter while staying other parameters constant. For a < 0.2 , reiterations of the WINDMI chaotic map converge to infinity from all initial conditions. For a > 1 , nearly all initial conditions converge to infinity see Figure 9. The bifurcation diagram is thus bounded to the extent $0.2 < a < 1$, where limited solutions can be held. Among $a = 0.75$ and $a = 1$, the border set composed of a sole value. This is compatible with the stable regime, but one that should be held in this case as a period-1 periodic path. At $a = 0.75$, a bifurcation happens, providing giving birth to a period-2 periodic orbit (Iterations swing among two worths). This is a paradigm of -doubling the bifurcation period. At $a = 5.5$, there is a path of the period-4 that is readily visible in the bifurcation diagram and so on. The bifurcation at $a = 0.35$ in Figure 9, is barely apparent, and fully unapparent to the naked eye.

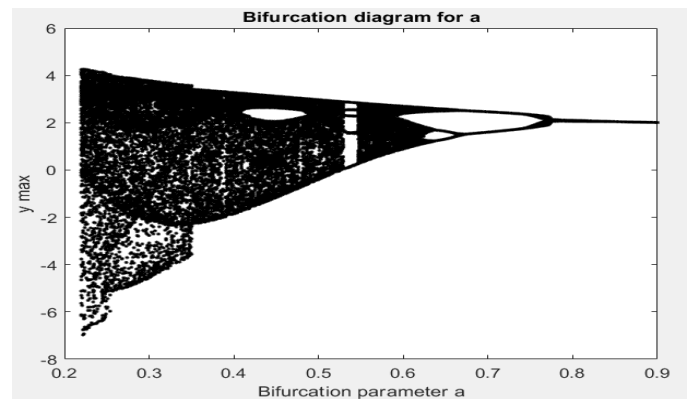

Fig. 9. Bifurcation Diagram

F. Power Spectral Density Property

There are various ways for spectrum appreciation. This research employs a periodogram, which is the majority widespread method to estimate the PSD of a chaotic signal using discrete Fourier transform. The spectrum assessments for $(x, y, \text{ and } z)$ for low ($a = 0.1, b = 1$) and high ($a = 0.7$ and $b=3.5$) are display in Figures 10 and 11, respectively.

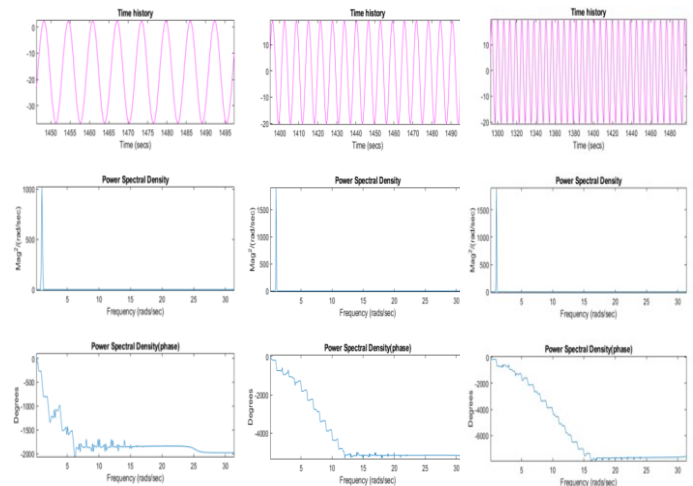

Fig. 10. WINDMI Chaotic System PSD for $(x, y, \text{ and } z)$ at Low ($a = 0.1, b = 3.5$)

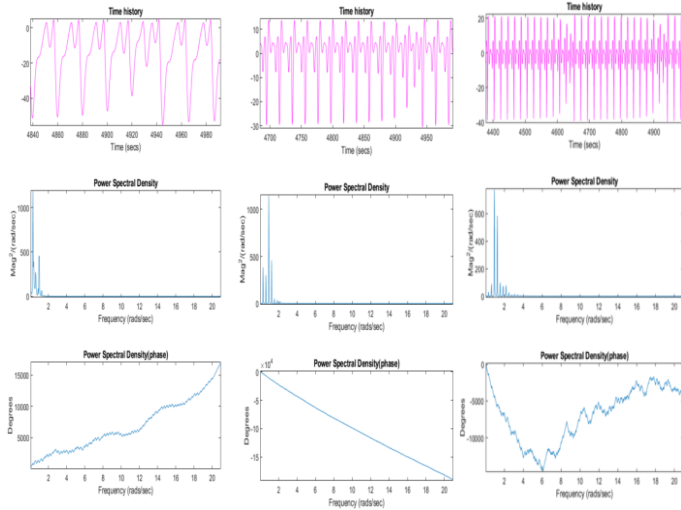

Fig. 11. WINDMI chaotic system PSD for (x, y, and z) at high (a = 7.1, b = 3.5)

The power spectrum density of the windmi chaotic signal, when the series extend to 2048 points and the sampling time of 0.15 s. The peak at 0.3 Hz is obtained by the length of the sequences. The peak at 1 Hz is an odd harmonic of the peak at 0.3 Hz. PSD parameters of WINDMI chaotic signal are displayed in tables I, II.

Table I
PSD Parameter for Initial Condition a = 0.7, b = 3.5

Initial Condition (a = 0.7, b = 3.5) & Sequences length (2048)			
planes	X plane	Y plane	Z plane
Sampling time in sec	0.15	0.15	0.15
Frequency of the Peak in Hz	0.5	1.5	1.375
Frequency of the peak for odd harmonics in Hz	1.875	2	2

Table II
PSD Parameter for Initial Condition a = 0.1, b = 1

Initial Condition (a = 0.1, b = 1) & Sequences length (2048)			
planes	X plane	Y plane	Z plane
Sampling time in sec	0.15	0.15	0.15
Frequency of the Peak in Hz	0.9375	1.125	0.75
Frequency of the peak for odd harmonics in Hz	-----	-----	-----

VI. EXPERIMENTAL RESULTS

Reconfigurable computing has contributed many solutions to countless engineering cases. Field-Programmable analog array (FPAA) technologies are the ideal solution for countless analog signal processing implementations. This technology contains many components for each chip, such as integrators, multipliers, summing, gain, filters, and other blocks. It provides high accuracy, electronic efficiency, and ease of implementation compared to DSP processors. FPAAs provide the ability to change specifications designed in real-time to meet requirements with the variable demand of the system. FPAA reconfigurable technologies have shown increased

growth in versatility due to their minimal energy consumption[46]. It is used for biomedical usages [47], data processing [48], dealing with images [49], and robotics tracking [50]. FPAA technologies have the ability to update and adapt to various circumstances without the need for a reset [51]. The AN231E04 FPAA chip is composed of a 2x2 matrix of complete computation analog blocks (CABs), encompassed by programmable linking sources and analog input/output cells with robust components as shown in Figure 12. The AN231E04 chip Characteristics seven configurable input/output every utilized as input or output in addition to a master signal generator used to generate the required frequency signals. Arranged data is stowed in SRAM configuration memory. This memory is allowed for various circuits to be loaded without deactivating the present circuit employment see Figure 12[52].

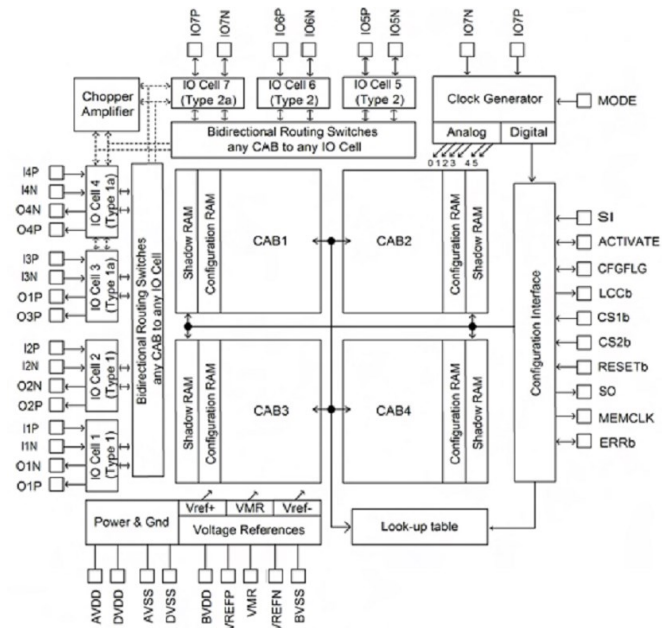
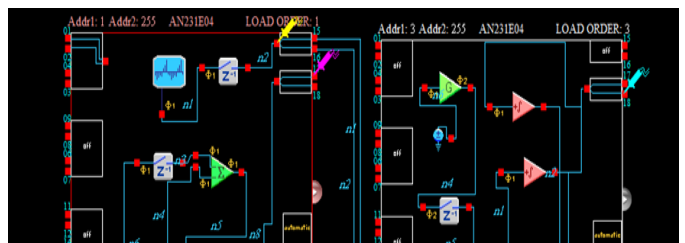

Fig. 12. Architectural Overview of Anadigm FPAA AN231E04 [52]

Simulink software is recognized worldwide as a standard simulation tool. In this paper, WINDMI chaotic system is designed and built using MATLAB/Simulink. The results obtained are used to form the validity of the FPAA circuit. Specialized development software Anadigm Designer2 is used to design a WINDMI chaotic system described by the mathematical relationship clarified by equations (1-3) in addition to MATLAB. The circuit of the proposed system is built by the desired CAMs. Various ingredients can be factorized as necessary, for example, the user can adjust the differential factors for differentials, etc. The FPAA chip will not permit inconsistent components to be linked. For example, all linked components should be adjusted to a similar clock frequency. For example, all linked components should be adjusted to a similar clock frequency. If there is no compatibility between the CAMs used in the proposed circuit, the device will link the ingredients with a punctate line. Figure 13 shows the implementation of the WINDMI chaotic system structure of Simulink design display in figure 3 using two AN231E04 FPAA chips.



features can be watched from the time series, power spectral density, bifurcation diagram, and correlation properties. The simulation presents that the WINDMI chaotic system has a locative bounded noncyclic orbit and offers sensitivity based on initial conditions. Eventually, the electrical circuit for the WINDMI chaotic system was constructed and the match results of the electrical circuits applied on the FPAA chip with those of MATLAB simulations have been Noticed. Given that they are very affected by its initial conditions, which allow generating an unlimited number of signals, WINDMI chaotic signal can be considered a promising signal in CDMA applications.

ACKNOWLEDGEMENTS

We are very grateful to experts for their appropriate and constructive suggestions to improve this template.

REFERENCES

- [1] A. Shafique, J.Ahmed W. Boulila, H. Ghandorh, H. Ghandorh, J.ahmad, and M. UR, "Rehman Detecting the Security Level of VariousCryptosystems Using Machine Learning Models",. *IEEE ACCESS*.2021, vol.9, pp. 9383-9393. <https://doi.org/10.1109/ACCESS.2020.3046528>
- [2] Y. Chen., Y. Huang, J. Fu, Y. Han, K. Li, and J. Yu (2021), "Multi Wings chaotic encryption scheme for PAM-DMT-based optical access network",. *IEEE Photonics Journal*, vol. 13, No.1, February 2021,pp. 7900408-7900408. <https://doi.org/10.1109/JPHOT.2020.3047920>
- [3] M Mamat, S Vaidyanathan, A Sambas, Mujiarto3, W S M Sanjaya, Subiyanto, "A novel double-convection chaotic attractor, its adaptive control, and circuit simulation", *IOP Conf.*(2018) Series: Materials Science and Engineering, 2018, vol. 332, pp.1-15. <https://doi.org/10.1088/1757-899X/332/1/012033>
- [4] A. Sambas., M. Mamat, S. Vaidyanathan, M. A. Mohamed and W. S. MadaSanjaya, "A new 4-D chaotic system with hidden attractors and its circuit implementation", *International Journal of Engineering & Technology*, vol.7, No.3, 2018, pp.1245-1250. <https://doi.org/10.14419/ijet.v7i3.9846>
- [5] Aceng S., Mujiarto, M. Mamatb, and W. S. M.Sanjayac, "Numerical simulation and circuit implementation for a Sprott chaotic system with one hyperbolic sinusoidal nonlinearity", *Far East Journal of Mathematical Sciences*, vol. 102, No. 6, 2017, pp.1165-1177.
- [6] S. Sundarapandian Vaidyanathan., S. T. Kingni, A.Sambas, M.A. Mohamed and M. Mamat , "A new chaotic Jerk system with three nonlinearities and synchronization via adaptive backstepping control", *International Journal of Engineering & Technology*, vol.7, No.3, 2018, pp.1936-1943. <https://doi.org/10.14419/ijet.v7i3.15378>
- [7] S. Vaidyanathan, "Synchronization of Tokamak systems with symmetric and magnetically confined plasma via adaptive control," *International Journal of ChemTech Research* ,vol.8,No.6, 2015,pp.818-827.

Fig. 13. The Implementation of the WINDMI Chaotic System Structure

Anadigm Designer2, software permits the user to paradigm a circuit and immediately perform it on the FPAA chip. The circuit consists of three integrators, a summing amplifier, a DC power supply, and gain units. Arbitrary Periodic Waveform Generators are used to generate exponential signal see Figure 13. The sample and hold unit is utilized to face the loss of compatibility between the different units which is the most important problem that faces the implementation of the proposed system. This trouble causes fading and distortion in the form of the WINDMI system output signal.

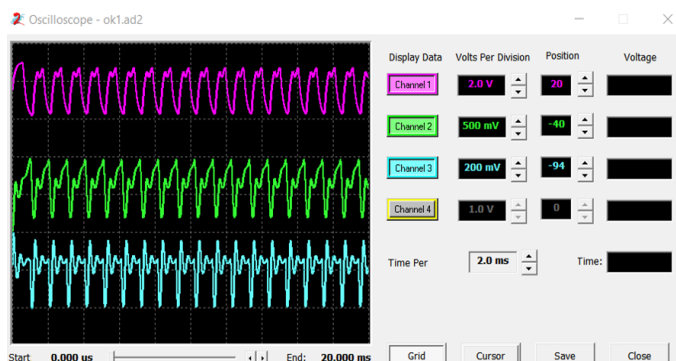

Fig. 14. Windmi Chaotic System output at a = 0.7, b = 3.5

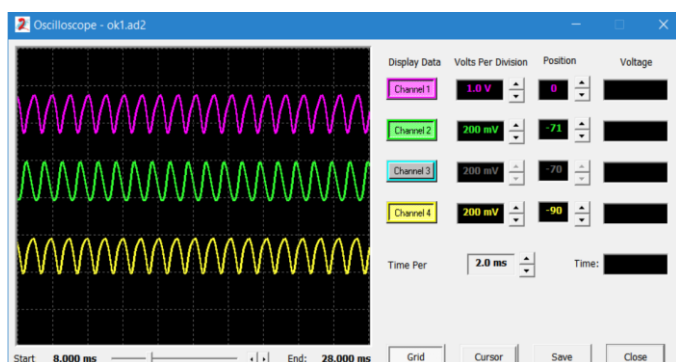

Fig. 14. Windmi Chaotic System output at a = 0.1, b = 1

CONCLUSION

A prototype for WINDMI chaotic oscillator based on Field Programmable Analog Arrays (FPAAs) is presented in this paper. For the case study a =0.7, and b=3.5 the system is chaotic and it establishes a chaotic attractor, and these chaotic

- [8] G. G. Bulut , M. E. Şahin, H.Güler, "An implementation of chaotic circuits with Multisim-LabVIEW", *International Advanced Researches and Engineering Journal*.vol. 02No.032018,pp.304-308.
- [9] C. Li., J. C. Sprott, W. Thio, and H. Zhu, "A new piecewise linear hyperchaotic circuit", *IEEE Transactions On Circuits And Systems—II: Express Briefs*, vol.61, No.12, 2014, pp.977-981. <https://doi.org/10.1109/TCSII.2014.2356912>
- [10] S. Vaidyanathan,"Analysis synchronization of two novel chaotic systems with hyperbolic sinusoidal and cosinusoidal nonlinearity and unknown parameters", *Journal of Engineering Science and Technology Review* , vol.6, No.4, pp. 53-65. <https://doi.org/10.25103/jestr.064.07>
- [11] S. Vaidyanathan, K. Rajagopal, Ch. K. Volos, I. M. Kyprianidis and I. N. Stouboulos , " Analysis, adaptive control and synchronization of a seven-term novel 3-d chaotic system with three quadratic nonlinearities and its digital implementation in LabVIEW", *Journal of Engineering Science and Technology Review* , vol.8, No. 2, 2015, pp.130 – 141. <https://doi.org/10.25103/jestr.082.18>
- [12] G.Kaddoum, "Wireless chaos-based communication systems: a comprehensive survey ", *IEEE ACCESS*, vol.4,2016,pp.2621-2648. <https://doi.org/10.1109/ACCESS.2016.2572730>
- [13] L. Minati , M. Frasca, N. Yoshimura, and Y.Koike , "Versatile locomotion control of a hexapod robot using a hierarchical network of nonlinear Oscillator Circuits", *IEEE ACCESS*, vol.6, 2018, pp. 8042-8065. <https://doi.org/10.1109/ACCESS.2018.2799145>
- [14] V. Sundarapandian, I. Pehlivan , " Analysis, control, synchronization, and circuit design of a novel chaotic system", *Mathematical and Computer Modelling Journal*, vol.55, 2018, pp.1904-1915. <https://doi.org/10.1016/j.mcm.2011.11.048>
- [15] S. Çiçek, A. Ferikoğlu, and İ. Pehlivan , "Electronic circuit design of Sprott chaotic system with CCII+. *IEEE*", *22nd Signal Processing and Communications Applications Conference* , 2014, pp. 2015-2018. <https://doi.org/10.1109/SIU.2014.6830654>
- [16] S. Vaidyanathan, "Analysis and adaptive synchronization of two novel chaotic systems with hyperbolic sinusoidal and cosinusoidal nonlinearity and unknown parameters", *Journal of Engineering Science and Technology Review*, vol.6, No.4, 2013, pp.53-65. <https://doi.org/10.25103/jestr.064.07>
- [17] M. Garcia-Bosque, A. Pérez-Resa , C. Sánchez-Azqueta, C. Aldea and S. Celma , " Chaos-based Bitwise dynamical pseudorandom number generator on FPGA", *IEEE Transactions on Instrumentation and Measurement* , vol.12, 2018, pp. 1-4. <https://doi.org/10.1109/TIM.2018.2877859>
- [18] D. Kumar, K. Nabi, P. K. Misra and M. Goswami , "Modified Tent Map-based design for a truly random number generator", *IEEE International Symposium on Smart Electronic Systems* , 2018, pp.27-30. <https://doi.org/10.1109/iSES.2018.00016>
- [19] W. Lv, R. Bail, and X. Sun," Image encryption algorithm based on hyperchaotic Lorenz Map and compressed sensing theory ", *Proc. of the 38th Chinese Control Conference*, 2019, pp.3405-3410. <https://doi.org/10.23919/ChiCC.2019.8866148>
- [20] Y.ZHANG, and R. LU, "A novel hybrid chaotic sequence and its performance analysis", *Third International Conference on Cyberspace Technology* , 2015, pp.1-4. <https://doi.org/10.1049/cp.2015.0812>
- [21] A. Sambas, S. Vaidyanathan, M. Mamat,W.S. M. Sanjaya and D. S.Rahayu , "A 3-D novel Jerk chaotic system and its application in secure communication systems and mobile robot navigation," *Advances and Applications in Chaotic Systems, Studies in Computational Intelligence*. Springer International Publishing Switzerland,2016, pp.283-310. https://doi.org/10.1007/978-3-319-30279-9_12
- [22] D. Butusov, T. Karimov, A. Voznesenskiy, D. Kaplun, V. Andreev and V. Ostrovskii, "Filtering Techniques for Chaotic Signal Processing", *Electronics Journal*, vol.7, No.450, 2018, pp.1-14. <https://doi.org/10.3390/electronics7120450>
- [23] A. Riaz. and M. Ali., "Chaotic communications, their applications and advantages over traditional methods of communication. *Proc. of 6th International Symposium on Communication Systems, Networks and Digital Signal Processing*, 2008, pp.21-24. <https://doi.org/10.1109/CSNDSP.2008.4610808>
- [24] L. Zhuang, L. Cao, Y.Wu, Y. Zhong, L. Zhangzhong, W. Zheng, and L. Wang, "Parameter estimation of Lorenz chaotic system based on a hybrid Jaya-Powell algorithm", *IEEE ACCESS Journal* vol.4, 2016, pp.1-8. <https://doi.org/10.1109/ACCESS.2020.2968106>
- [25] X.Zhao1, J. Liu, H. Liu, F. Zhang, "Dynamic analysis of a one-parameter chaotic system in a complex field", *IEEE ACCESS Journal* vol.4, 2016, pp.1-8. <https://doi.org/10.1109/ACCESS.2020.2968226>
- [26] S.Vaidyanathan, C. Volos, V. Pham, K. Madhavan and B. Idowu, "Adaptive backstepping control, synchronization, and circuit simulation of a 3-D novel jerk chaotic system with two hyperbolic sinusoidal nonlinearities", *Archives of Control Sciences journal* ,vol.24, No.3, 2014, pp.375–403. <https://doi.org/10.2478/acsc-2014-0022>
- [27] S. Vaidyanathan and A. T. Azar, "Analysis, control, and synchronization of a nine-term 3-d novel chaotic system chaos modeling and control systems design", *Chaos Modeling and Control Systems Design*", 2015, pp.19-38.
- [28] A. Dwivedi, A. K. Mittal and S. Dwivedi, "Chaotic communication using Pecora Carroll complete replacement and parameter modulation without the controller", *Proc.of Students Conference on Engineering and Systems*, 2014, pp1-4. <https://doi.org/10.1109/SCES.2014.6880060>
- [29] A . A Koronovskii, O I Moskalenko, A E Hramov, "On the use of chaotic synchronization for secure communication", *Physics - Uspekhi Journal* vol.52 No.12, 2009, pp.1213-1238. <https://doi.org/10.3367/UFNe.0179.200912c.1281>
- [30] Z. Wang, Y. Sun, B. Jacobus V. Wyk, and G. Qi,M. A. Van Wyk, "A 3-D four-wing attractor and its

- analysis", *Brazilian Journal of Physics*, vol. 39, No.3, 2009, pp.547-553. <https://doi.org/10.1590/S0103-97332009000500007>
- [31] X.Liu,X.Shen and H. Zhang, "Multi-scroll chaotic and hyperchaotic attractors generated from chen system", *International Journal of Bifurcation and Chaos*, vol.22, No.2.2012, pp.1250033-1-15. <https://doi.org/10.1142/S0218127412500332>
- [32] L.Pan, W. Zhou, J. Fang, D.Li,"A new three-scroll unified chaotic system coined", *International Journal of Nonlinear Science* vol.10, No.4, 2010, pp.462-474.
- [33] J. Lu, G. CHEN and D. CHENG, "A new chaotic system and beyond: the generalized Lorenz-like system", *International Journal of Bifurcation and Chaos*, vol.14,No. 5, 2004, pp.1507-1537. <https://doi.org/10.1142/S021812740401014X>
- [34] S. Dadras and H. R. Momeniy, "Generating one-, two-, three- and four-scroll attractors from a novel four-dimensional smooth autonomous chaotic system", *Chin. Phys. B*,vol.19, No.6, 2010, pp.060506-1-8 <https://doi.org/10.1088/1674-1056/19/6/060506>
- [35] W. Liu, and G. Chenc., "An a the three-dimensional smooth autonomous quadratic chaotic system generates a single four-scroll attractor?", *International Journal of Bifurcation and Chaos*, vol.14, No. 4, 2004, pp.1395-1403. <https://doi.org/10.1142/S0218127404009880>
- [36] M. D. Prokhorov, V. I. Ponomarenko, D. D. Kulminskiy, A. A. Koronovskii, O. I. Moskalenko, A. E. Hramov, "Resistant to noise chaotic communication scheme exploitingthe the regime of generalized synchronization", *Proc. 24th Telecommunications Forum*,2016, pp.1-12. <https://doi.org/10.1007/s11071-016-3174-6>
- [37] S. Vaidyanathan, C.K. Volos, I. M. Kyprianidis, I. M. Kyprianidis, K. Rajagopal, and P. Alexander, "Anti-synchronization of WINDMI systems via adaptive backstepping control and method and its FPGA implementation", *Proc.of 18th International Conference on Circuits, Systems, Communications and Computers*,pp.2015, pp.86-91.
- [38] B. Xin, T. Chen, and Y. Liu ," Synchronization of chaotic fractional-order WINDMI systems via linear state error feedback control", *Mathematical Problems in Engineering. Maximize* , 2010, pp.1-10. <https://doi.org/10.1155/2010/859685>
- [39] S.Rasappan, and S.Vaidyanathan, "Global chaos synchronization of WINDMI and coullet chaotic systems using adaptive backstepping control design", *Kyungpook Math. J.*, vol.54, 2014, pp.293-320. <https://doi.org/10.5666/KMJ.2014.54.2.293>
- [40] S. Vaidyanathan, Ch. K. Volos, K. Rajagopal, I. M. Kyprianidis, and I. N. Stouboulos ,"Adaptive backstepping controller design for the anti-synchronization of identical WINDMI chaotic systems with unknown parameters and their SPICE Implementation", *Journal of Engineering Science and Technology Review*,vol. 8,No.2, 2015,pp. 74 – 82. <https://doi.org/10.25103/jestr.082.11>
- [41] J. Wang, D. Lu, and L.Tian, "Global synchronization for time-delay of WINDMI System",*Chaos, Solitons and Fractals* , vol.30, 2006, pp.629–635. <https://doi.org/10.1016/j.chaos.2005.04.010>
- [42] W. Horton and I. Doxas, "A Low-Dimensional dynamical model for the solar wind the driven geotail-ionosphere system, *Journal of Geophysical Research: Space Physics*, vol. 103, No.A3, 1997, pp.4561–4572. <https://doi.org/10.1029/97JA02417>
- [43] J.P.Smith,J.-L.Thiffeault and W.Horton, "Dynamical range of the WINDMI model: An exploration of possible magnetospheric plasma states, *Journal of Geophysical Research*", vol.105, No.A6, 2000,pp.12.983-12.996. <https://doi.org/10.1029/1999JA000218>
- [44] J. C. Sprott," *Chaos and Time-Series Analysis*", Oxford University Press, New York, NY, USA, 2003.
- [45] S. Shah. and J. Hasler, "Low Power Speech Detector on an FPAA", *IEEE International Symposium on Circuits and Systems*, 2017, pp.1-4. <https://doi.org/10.1109/ISCAS.2017.8050755>
- [46] J. Hasler., S. Shah,"An SoC FPAA Based Programmable, Ladder-Filter Based, Linear-Phase", *IEEE Transactions on Circuits and Systems I*, vol.68, No.2, 2012, pp.592–602. <https://doi.org/10.1109/TCSI.2020.3038360>
- [47] S. Shah, H. Toreyin, O. T. Inan, and J. Hasler, "Reconfigurable Analog Classifier For Knee-Joint Rehabilitation", *Proc. of 38th Annual International Conference of IEEE Engineering in Medicine and Biology Society*, 2016, pp.4784-4787. <https://doi.org/10.1109/TBME.2016.2641958>
- [48] S.-Yu Peng, P. Hasler,and David V. Anderson, "An Analog programmable multi-dimensional radial basis function-based classifier.IEEE Transactions on Circuits And Systems—I: vol.54, No.10, 2017, pp.2148-2158. <https://doi.org/10.1109/TCSI.2007.905642>
- [49] C. Schlottmann, S. Nease, S. Shapero, and P. Hasler, "A Mixed-mode FPAA SoC for analog-enhanced signal processing", *Proc. of the IEEE Custom Integrated Circuits Conference*, 2012, pp. 1-4. <https://doi.org/10.1109/CICC.2012.6330679>
- [50] S. Koziol,, P. Hasler and M. Stilman, "Robot Path planning using field-programmable analog arrays", *Proc. of International Conference on Robotics and Automation*, 2012, pp.1-6. <https://doi.org/10.1109/ICRA.2012.6225303>
- [51] A. Macho, F.García-Loro, R. Gil, P. Baizán, E. Sancristobal, C. Perez, M.Blazquez, G. Díaz, and M. Castro ,"Work in progress: Proof of concept: remote laboratory Raspberry Pi + FPAA", *IEEE World Conference on Engineering Education*, 2019, pp.1-4. <https://doi.org/10.1109/EDUNINE.2019.8875827>
- [52] AN231E04 Datasheet Rev 1.0,3rd Generation Dynamically Reconfigurable dpASP, www.anadigm.com