

DOI: <https://doi.org/10.24425/amm.2022.137814>M. HOSADYNA-KONDRACKA^{1*}, K. MAJOR-GABRYŚ², M. WARMUZEK¹, M. BRŪNA³

QUALITY ASSESSMENT OF CASTINGS MANUFACTURED IN THE TECHNOLOGY OF MOULDING SAND WITH FURFURYL-RESOLE RESIN MODIFIED WITH PCL ADDITIVE

This paper deals with the issue of using moulding sands with a new two-component binder: furfuryl-resole resin – PCL polycaprolactone for the production of ductile iron heavy castings. The previous laboratory studies showed the possibility of using biodegradable materials as binders or parts of binders' compositions for foundry moulding and core sands. The research proved that addition of new biodegradable PCL in the amount of 5% to the furfuryl-resole resin does not cause significant changes in moulding sand's properties. The article presents research related to the production of ductile iron castings with the use of moulds with a modified composition, i.e. sands with furfuryl resole resin with and without PCL. Mechanical properties and microstructure of the casting surface layer at the metal/ mould interface are presented. The obtained test results indicate that the use of a biodegradable additive for making foundry moulds from moulding sand with a two-component binder does not deteriorate the properties of ductile iron castings.

Keywords: Moulding Sand; Organic Binder; Biodegradable PCL additive; Ductile cast iron

1. Introduction

Recently, important changes have occurred in the structure of the European foundry industry, such as a rapid development in the production of castings from compacted graphite iron and light alloys at the expense of limiting the production of steel castings. The production of heavy steel and iron castings (exceeding the weight of 30 Mg) for the metallurgical, cement and energy industries is still needed. The problem is proper moulding technology for such heavy castings, whose solidification and cooling time may take even several days, exposing the moulding material to a long-term thermal and mechanical load. Owing to their technological properties, sands with organic binders (synthetic resins) are the compositions used most often in industrial practice. The other problem in production of heavy castings in moulding sands is a waste sand and/or regenerated dust. According to the tendencies observed in recent years, moulding processes must meet high requirements connected to environmental protection. One of scientific research directions is a gradual replacement of binding materials produced from petrochemical origin, with biopolymers coming from renewable resources, which is consistent

with the conception of sustainable development – one of the priorities of the European Community policy [1-2].

The trend is also observed in foundry technologies development. In the 90's the General Motors Co. elaborated a new binding system based on protein composition GMBOND [3]. The materials in the protein binder come from natural renewable resources and consist of polypeptide chains, which are non-toxic (safe) for the environment. The binder is well soluble in water and the binding process begins during the dehydration reaction of wet moulding sand. The technological experiments using the protein binder showed good enough castings properties, though the binder quantity was reduced of 45% in comparison to the furfuryl resin binder quantity used in core production by hot-box technology [3]. Another example of using biodegradable materials in moulding sands technologies are tests conducted by K. Rusin's scientific group [4] with the usage of biogenic binders based on proteins obtained from by-products of pharmacy industry production. The water soluble not toxic polymers, including different polypeptide molecules with long amino acids chains were tested. The amount of the binder was 0.25-2.0%. There is no chemical reaction in the process, only the reaction of dehydration

¹ LUKASIEWICZ RESEARCH NETWORK – KRAKOW INSTITUTE OF TECHNOLOGY, 73 ZAKOPIAŃSKA STR., 30-418 KRAKOW, POLAND

² AGH UNIVERSITY OF SCIENCE AND TECHNOLOGY, FACULTY OF FOUNDRY ENGINEERING, DEPARTMENT OF MOULDING MATERIALS, MOULD TECHNOLOGY AND FOUNDRY OF NON-FERROUS METALS, AL. MICKIEWICZA 30, 30-059 KRAKOW, POLAND

³ UNIVERSITY OF ŽILINA, DEPARTMENT OF TECHNOLOGICAL ENGINEERING, FACULTY OF MECHANICAL ENGINEERING, UNIVERZITNÁ 1, 010 26, SLOVAK REPUBLIC

* Corresponding author: malgorzata.kondracka@kit.lukasiewicz.gov.pl



during the heating process. This kind of moulding sand can be used for light alloys like aluminum castings [4]. B. Grabowska [5-6] proposed use of aqueous biodegradable polymeric compositions consisting of acrylic derivatives and modified natural polymers as foundry moulding sands' binders (BioCo binders). The author proved that moulding sands with new binders show good enough compression (2 MPa) and bending (1 MPa) strength after 1h of sample hardening. Moulding sands with BioCo binders can be used in iron castings production [6].

The newest trend of global corporations in the production of foundry materials is the use of additives to the binders to improve moulding sands properties [7]. From the point of view of foundry practice, this may be a solution that will be of interest. It consists in modernizing a well-known and widely used technology without the need to change the production profile. Literature data [8-12] shows that there is a possibility of using biodegradable materials as additives for petrochemical materials to increase their biodegradability. Further advantages of using biodegradable polymers, such as PCL, as additives might include increase in flexibility of moulding sands with new two-component resins. Low flexibility of moulding and core sands is a problem in automated foundries [13-14]. The use of PCL as a plasticizer for plastics is not a new matter. From a technological point of view, the use of plasticizers for polymers is very important and widely used in various industries. In 1966 the use of PCL as a plasticizer for polyvinyl chloride (PVC) was patented [10-11]. The preliminary research presented in Ref. [8-9] has shown that the moulding sands with biodegradable materials as binders are not only less toxic but they have a greater ability for mechanical regeneration than traditional synthetic resin moulding sands. It can be concluded that the partial replacement of the petrochemical origin binder with biodegradable material will improve the quality of tested moulding sands [6-7]. An analysis of literature data and own research results led the authors to a new perspective on the production of moulding and core sands that is based on partial replacement of synthetic foundry resins with biodegradable materials [8-9]. This approach will reduce the technological costs in relation to process which used only biodegradable material as moulding sand's binder. At the same time, it will allow to modify well-known and widely used mould and core preparation technologies.

Thus, the effect of use of moulds made of moulding sand with biodegradable materials to cast ductile cast iron was examined in this work. The quality, i.e. mechanical properties and microstructure characteristic, of the cast parts poured to sands moulds both, standard and modified, were examined and discussed.

2. Research Methodology

The following materials were selected as components for the new binders.

- Furfuryl-resole resin, without contain of nitrogen and the free formaldehyde in the range of 0.05-0.15%; the amount of furfuryl alcohol 78%.
- Hardener – an aqueous solution of paratoluenesulfonic acid.

- Polycaprolactone (PCL) – a biodegradable additive and plasticizer; a biodegradable polymer in solid form with an end of hydroxyl group. PCL was dissolved in furfuryl-resole resin without need of using additional solvent.

The moulding sand mixtures were based on fresh silica sand from Grudzen Las characterized by the following parameters: granulation 0.20/0.32/0.40; $d_{50} = 0.31$ mm; pH = 7. The composition of the sand mixtures is presented in TABLE 1. The moulding sands were prepared in a laboratory mixer LM-R1, using mixing times: sand + hardener – 60 seconds and sand + hardener + binder – 50 seconds.

TABLE 1

The composition of moulding sands used in test

Moulding sand no. 1		
silica sand	100 parts by mass	
furfuryl-resole resin	1.1 parts by mass	
hardener	50% of resin	
Moulding sand no. 2		
silica sand	100 parts by mass	
furfuryl-resole resin	1.1 parts by mass	95%
polycaprolacton (PCL)		5%
hardener	50% of resin	

Structural analyses of tested moulding sands were carried out using an Excalibur FTIR spectrometer with a standard DTGS detector and the resolving power of 4 cm^{-1} . The spectra of samples were obtained at room temperature using the transmission technique (KBr pellet). A small amount of liquid binder was smeared onto a KBr pellet (prepared by pressing KBr powder under force of $8 \cdot 10^3$ kg). The number of scans was constant for all samples [15].

The next stage of own research was to compare the properties of castings made in two forms: standard with furan resin and experimental with two-component binder.

Experimental castings from ductile cast iron were made in self-hardening loose sand molds, one with the addition of 100%

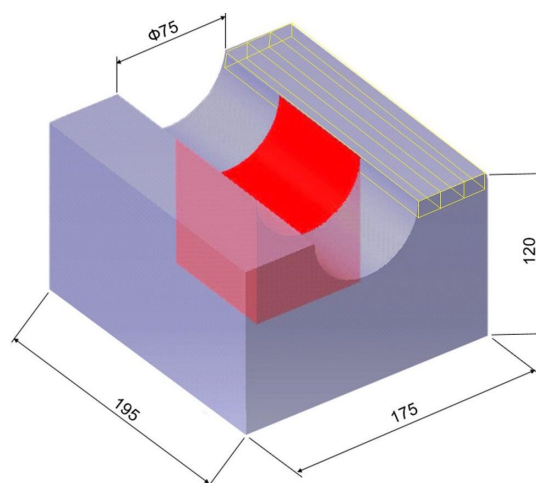

Fig. 1. The tested casting with marked sampling site for metallographic (red area) and mechanical properties (yellow mark) examinations [16-17]

furfuryl-resole resin and the other with the addition of a two-component binder.

The shape and design of prepared castings, as well as the sampling site, were determined based on literature data [16-17]. The aim of introducing the characteristic U-shape was to obtain the highest possible concentration of gas from the moulding material. A scheme of the casting is shown in Fig. 1.

The metal melting was carried out using the Radyne AMF 45/150 medium frequency induction furnace with crucible of 100 kg capacity of charge and neutral liner. Spheroidization and modification were performed in a slender ladle using FeSiMg9 mortar.

The moulds were poured with liquid metal with a drain temperature of about 1420°C and a pouring temperature of about 1370°C.

Chemical composition analysis of the examined alloy was made by optical emission spectrometry method (ARL MA spectrometer) and presented in TABLE 2.

Microstructure examinations were carried out on metallographic cross-sections, perpendicular to casting surface, etched with reagent Mi1Fe. The microstructure of the experimental castings was examined using the light microscope Zeiss Axio Observer Z1m and scanning electron microscope SCIOS FEI. Distribution of the chosen elements in the superficial layers at casting/mould interface was estimated by means of EDS microanalysis, using EDAX microanalyzer.

The tensile test of castings in ambient temperature was conducted according to PN-EN ISO 6892-1:2016-09 testing standard [18]. Examinations were carried out on EU-20 strength testing machine.

3. Results of examinations and discussion

3.1. Results of the spectroscopic studies of the new binder

The aim of the spectroscopic studies (FTIR) was to determine the effect of used biodegradable material on the structure of the new two-component binder. The results were registered for wave numbers from 4000 to 400 cm^{-1} with resolution 4 cm^{-1} as shown in Fig. 2.

PCL addition in the amount of 5% to the furan resin resulted in the appearance of a band at a wavenumber of 1105 cm^{-1} derived from the vibration of CH_2 in PCL (Fig. 3) [15-18]. There has also been a growth of intensity for band at wavenumber 1730 cm^{-1} caused by vibration of extending carbonyl bond $\text{C}=\text{O}$ with the addition of PCL [15, 19-23], which does not impact moulding sands' technological properties [8-9]. Other bands in the spectrum of the resin do not change with the addition of PCL.

3.2. Observations of the interaction layer between the mould material and the liquid alloy

Fig. 3 shows the moulds used to make the experimental castings.

On the surface of both moulds, made of two examined moulding sands (TABLE 1) some traces of interaction between mould material and liquid alloy were visible (Fig. 3). Based on the microscopic observation (Figs. 4a and 5a) one can assume

TABLE 2

Chemical composition analysis of the examined cast iron

Element	C	Si	Mn	P	S	Cr	Ni	Mg	Cu	Mo	V	W	Al	Ti
Content, % wt.	3.30	2.61	0.38	0.04	0.01	0.06	0.07	0.06	0.07	0.002	0.017	0.003	0.021	0.01

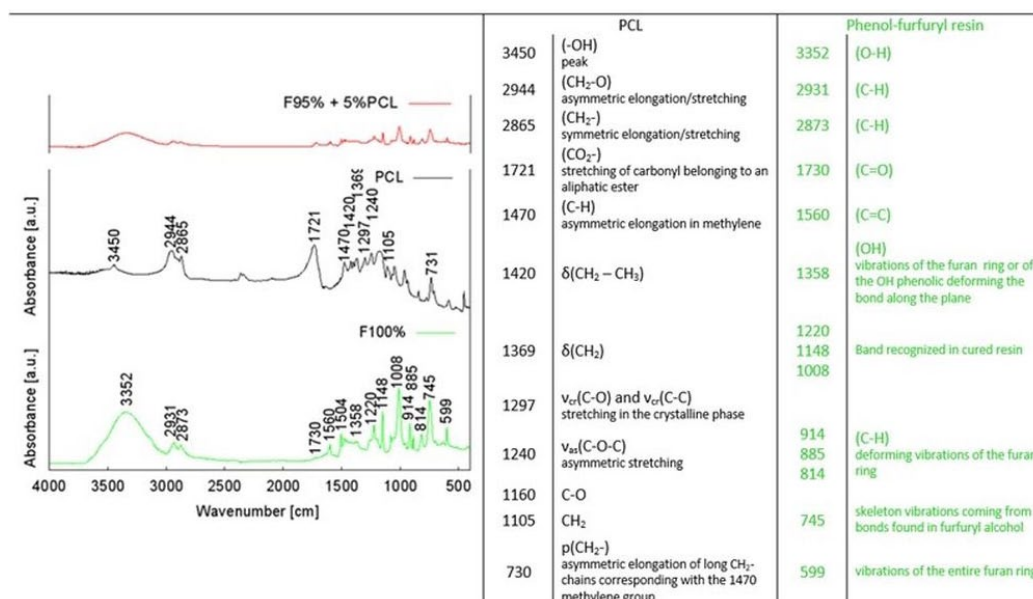

Fig. 2. FTIR spectrum of 100% furfuryl-resole resin, PCL and two-component binder [15,19-23]

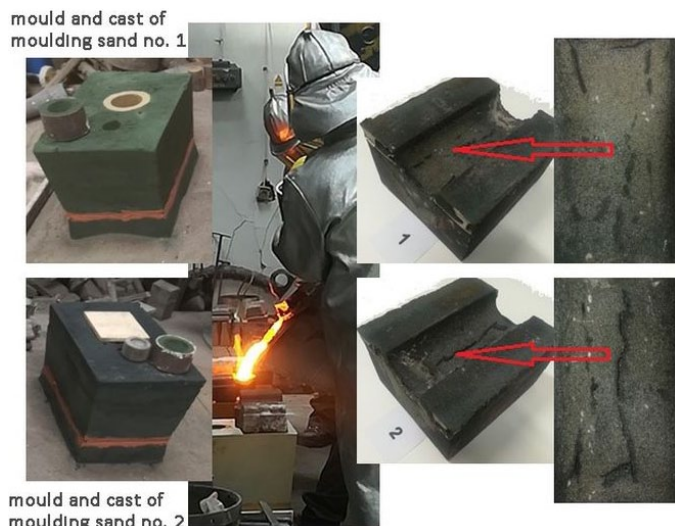

Fig. 3. Moulds and castings of moulding sands with (1) furfuryl-resole resin and (2) two-component binder (with marked area of intensive influence of moulding sand on casting's surface)

that on the casting surface the tightly adhering layer of the reaction products was formed.

The results of the EDS microanalysis, recorded along a line perpendicular to the casting surface, revealed some differences in the elemental composition of the transition layer formed at the mould/liquid metal interface (Figs. 4-5). In the specimen taken from casting No. 1 mutual replacement between Fe, O and S was recorded (Fig. 4b), while in the specimen taken from cast-

ing No. 2 there were revealed two different layers of elements replacement, first between Si and Fe and second between Fe, O and S (Fig. 5b).

Although only the preliminary research results are presented here, it can be assumed that the applied mould materials, including the addition of PCL, have a different effect on the transition layer between the mould surface and the liquid metal.

3.3. Microscopic examinations of cast parts microstructure

The microstructure observations were carried out near the surface layer of the experimental castings (Figs. 6 and 7).

The microstructure images show that in both examined castings similar state of the microstructure was obtained (Figs. 6a, 7a). The main constituent of the metal matrix was pearlite. The typical morphology of the bull-eyes, i.e. envelopes of ferrite around graphite nodules was characteristic for both examined castings. However, some differences between both castings in their superficial layer were revealed. In specimen taken from casting no. 2, the thin layer (of about 500 μm) of the degenerated graphite appeared (Fig. 7b). Such an effect was not seen in the specimen taken from the casting no. 1 (Fig. 6b). This microstructural effect could be related to the difference in the concentration profiles, especially Fe, Si, O and S (Fig. 4b and 5b) in the transition layer, which led to local differentiation of the solidification path of the casting. Therefore, it can be as-

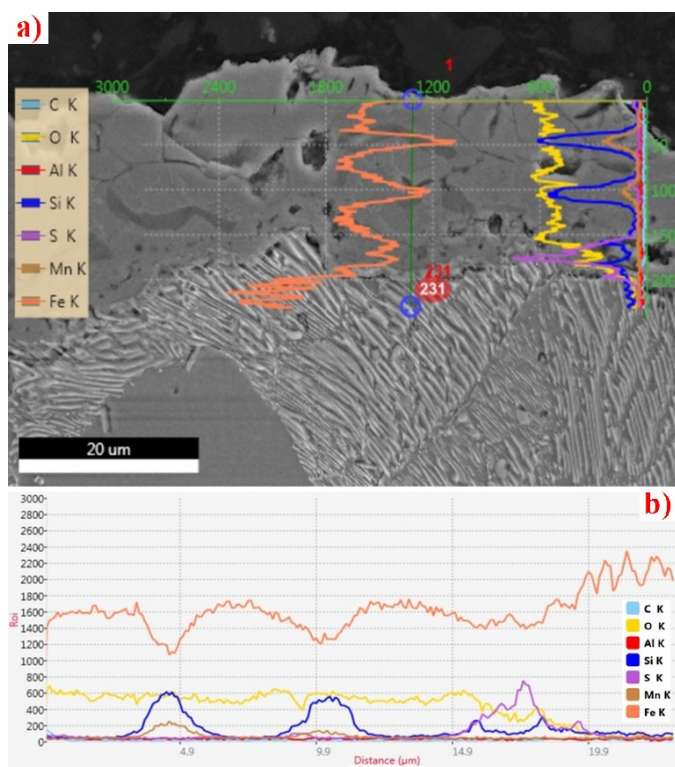

Fig. 4. Transition layer at mould/casting interface of the specimen taken from casting no. 1; a) Morphology of microstructure constituents, SEM, b) Profile of concentration of the selected elements, EDS

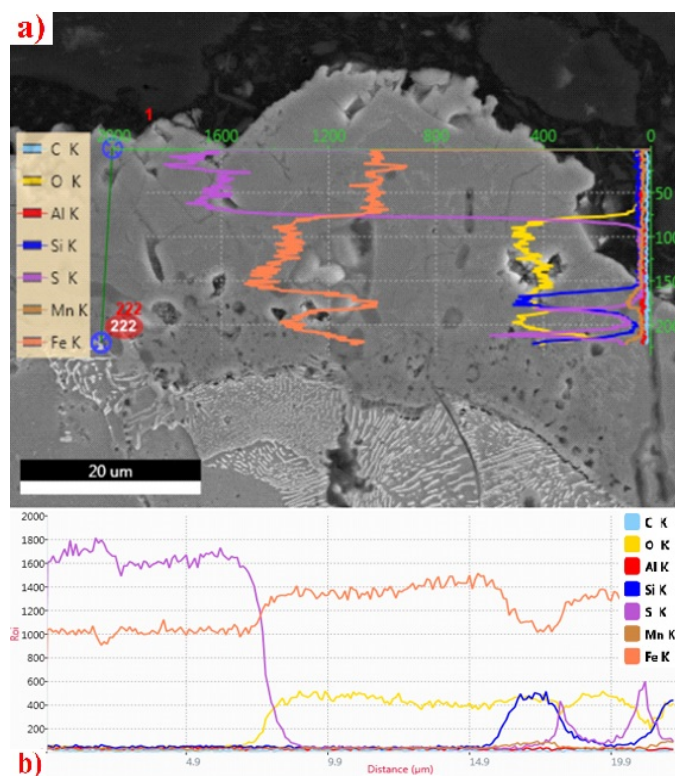

Fig. 5. Transition layer at mould/casting interface of the specimen taken from casting no. 2; a) Morphology of microstructure constituents, SEM, b) Profile of concentration of the selected elements, EDS

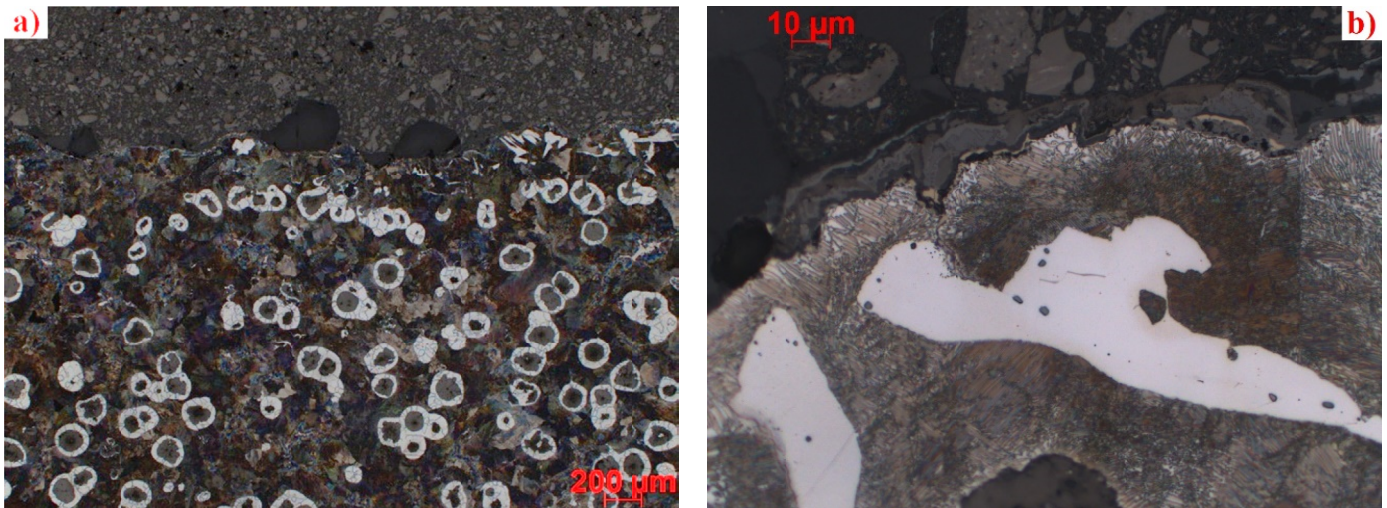

Fig. 6. Microstructure of the examined specimen taken from casting no. 1, LM; a) pearlite, ferrite, spheroidal graphite in zone near casting surface, b) superficial layer, visible film of the composed oxides

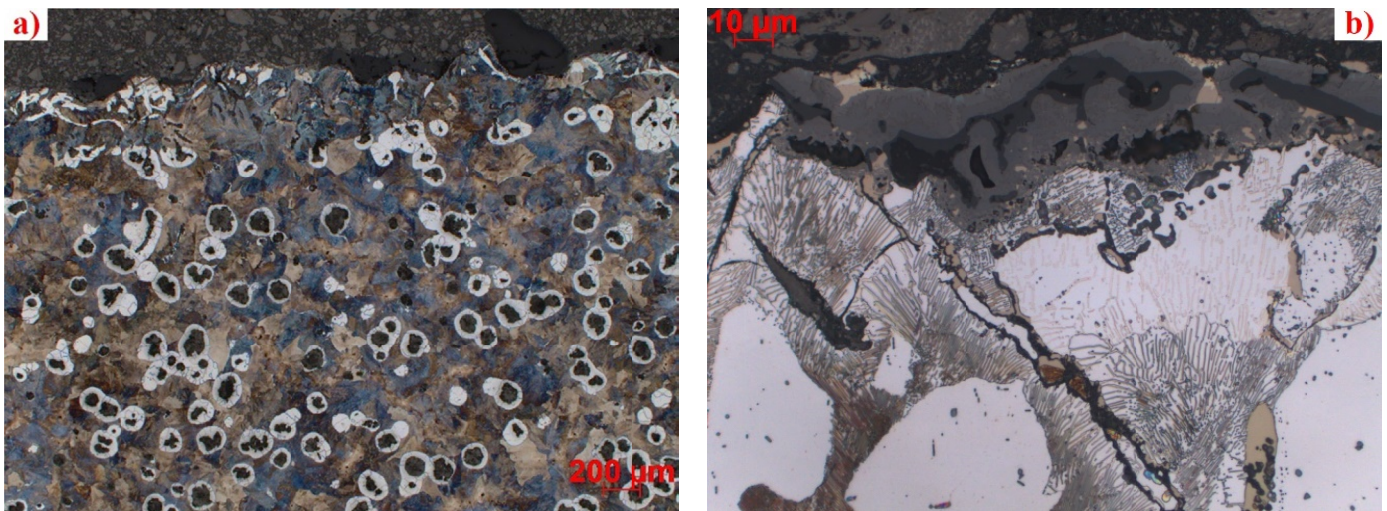

Fig. 7. Microstructure of the examined specimen taken from casting no. 2, LM; a) pearlite, ferrite, spheroidal graphite in zone near casting surface, b) superficial layer, visible film of the composed oxides

sumed that modifying the mould material by adding PCL may affect the microstructure and shape of the graphite particles in the material surface layers at the mould/casting interface.

3.4. Results of the standard tensile test

The obtained results of the mechanical properties tests are presented in TABLE 3.

The obtained results of measurements of the mechanical properties of both examined castings, i.e. cast into moulds from

standard and modified material, especially tensile strength UTS value above 600 MPa and elongation A above 3%, were adequate for examined grade of ductile cast iron [24]. Therefore, one can say that the use of PCL additive to moulding sand, allowed to maintain satisfactory values of mechanical properties of casting. However, there was stated an increase in the UTS value and a decrease in the YS and A values in casting no. 2 compared to these values measured for casting no. 1. More testing needs to be carried out at this stage of the research to confirm this trend, as it may be important for casting designers.

TABLE 3

Mechanical properties of samples from tested castings (average value of 3 measurements)

Sample number	0.2% proof strength, YS [MPa]	Tensile strength, UTS [MPa]	Elongation after fracture A [%]
Casting no. 1	356	656	6.0
Casting no. 2	333	672	4.2

4. Conclusions

The analysis of the results of the carried out research allowed to formulate the following conclusions:

- The addition of PCL in the amount of 5% to the furfuryl-resol resin caused the appearance of a new band at the wavenumber of 1105 cm⁻¹ and an increase in the intensity of the band at the wavenumber of 1730 cm⁻¹ in two-component binders, which, however, according to the literature data [8,9], does not affect technological properties of moulding sands.
- The differences in the microstructure of metal matrix and in the graphite particles shape revealed in superficial layers of the examined castings can be considered an effect of differentiated interactions at cast part / mould interface resulted from modification of the moulding sand composition, i.e. PCL addition.
- The results of the standard tensile tests showed that both tested castings, the one made in the standard form and the one in the form modified with the addition of PCL, had similar properties. Despite the observed slight differences, the values of UTS, YS and A were within the limits specified for the tested ductile iron in the standard [24].
- The obtained test results indicate that the use of a biodegradable additive for making foundry moulds from moulding sand with a two-component binder does not deteriorate the properties of ductile iron castings. Thus, a new perspective is created for the development of production of ecological moulding sands.

Acknowledgements

The acknowledgement to Dr Adelajda Polkowska for technical assistance. The research was financed by AGH Research Project No 16.16.170.654 and the Research Project No. 8007/00 financed by Ministry of Science and Higher Education.

REFERENCES

- [1] S. Kuciel, A. Liber-Kneć, S. Zajchowski, *Polimery* **54**, 10, 667-673 (2009).
- [2] A.K. Mohanty, M. Misra, L.T. Drzal, *Natural fibres, biopolymers, and their bio-composites*, CRC Press: UK (2005).
- [3] J. Eastman, *Modern Casting*, 32-34 (2000).
- [4] D. Kramářová, J. Brandštetr, K. Rusín, P. Henzlová, *Slávárenství* **60**, 2-3, 71-73 (2003).
- [5] B. Grabowska, M. Holtzer, R. Dańko, M. Górny, A. Bobrowski, E. Olejnik, *Metalurgija* **52**, 1, 47-50 (2013).
- [6] B. Grabowska, M. Szucki, J. Sz. Suchy, S. Eichholz, K. Hodor, *Polimery* **58**, 1, 39-44 (2013).
- [7] C. Fourberg, in: 5th Conference 'Materiały formierskie i rdzeniarskie – teoria i praktyka', Lublin, Poland, 5-8.10.2016.
- [8] K. Major-Gabryś, A. Grabarczyk, St.M. Dobosz, J. Jakubski, *Metalurgija* **55**, 2, 385-387 (2016).
- [9] K. Major-Gabryś, *JMEPEG* **28** (7), 3905-3911 (2019).
- [10] A. Iwamoto, Y. Tokiwa, *PolymerDegradat. Stabil.* **45**, 2, 205-213 (1994).
- [11] G.C. Eastmond, *Advances in Polymer Science* **149**, 59-222 (2000).
- [12] E.-J. Choi, J.-K. Park, *Polymer Degradat. Stabil.* **52**, 321-326 (1996).
- [13] P. Gröning, S. Schreckenber, K. Jenrich, *Giesserei* **102**, 01, 42-47 (2015).
- [14] A. Grabarczyk, St.M. Dobosz, V Conference of PhD Students at the Faculty of Foundry Engineering, 9th May, Kraków, AGH University of Science and Technology (2016)
- [15] K. Major-Gabryś, A. Bobrowski, A. Grabarczyk, St.M. Dobosz, *Arch. Metall. Mater.* **62** (1), 369-372 (2017).
- [16] M. Hosadyna-Kondracka, *Dobór mas formierskich dla ograniczenia niekorzystnego wpływu wybranych pierwiastków na strukturę odlewów żeliwnych*, PhD thesis AGH, Krakow (2012). (in Polish).
- [17] S. Puzio, J. Kamińska, K. Major-Gabryś, M. Angrecki, M. Hosadyna-Kondracka, *Archives of Foundry Engineering* **19**, 2, 91-96 (2019).
- [18] PN-EN ISO 6892-1:2016-09 „Metale. Próba rozciągania. Część 1: Metoda badania w temperaturze pokojowej”.
- [19] M. Bora, J.N. Ganguli, D.K. Dutta, *Termochimica Acta* **2**, 346-415 (2000).
- [20] M.S. Salil, J.P. Shrivastava, S.K. Pattanayak, *Chemical Geology* **136**, 1-2, 25-32 (1997).
- [21] Y. Liu, J. Gao, R. Zhang, *Polymer Degradation and Stability* **77**, 495-501 (2002).
- [22] R. González, J.M. Figueroa, H. González, *European Polymer Journal* **38**, 287-297 (2002).
- [23] Th. Linke, J.R. van der Sluis, In 60th World Foundry Congress, 26 September – 1 October 1993. Hague, The Netherlands: World Foundry Organization (1993).
- [24] PN-EN 1563:2018-10 „Odlewnictwo. Żeliwo sferoidalne”.