

Design of a Bandpass Rectangular Waveguide Filter Based on Direct Coupled Technique

Gouni Slimane, Damou Mehdi, Chetioui Mohammed, and Boudkhil Abdelhakim

Abstract—This paper presents how to design and simulate two different topologies of a bandpass (BP) rectangular waveguide filter using a direct coupled resonator technique operating at 12 GHz. The filters are characterized by a cross coupling (CM) which produces a single attenuation pole at finite frequency used to realize the bandpass response. The filter resonators provide 3rd and 4th order designs with a pseudo-elliptic response using High Frequency Structure Simulator (HFSS) simulator. Transmission zeros are obtained through coupling between the fundamental mode and high mode. The filter structures are validated leading to obtain transmission zeros close to the bandpass. The simulated waveguide filters with a central frequency exhibit an insertion loss of 0.4/0.3dB and a return loss of 20/23dB for the whole bandwidth ranging from 11.85GHz to 12.15GHz that show good electromagnetic responses for the simulated rectangular waveguide filters.

Keywords—Design; Simulation; Waveguide Filter; HFSS; Bandpass; Direct Coupling

I. INTRODUCTION

WITH the fast development of wireless communication systems, there will be an increasingly request for high quality components at microwave frequencies. Demands for bandpass filters (BPF) increase in order to get good performances for wireless communications with the regard of high insertion in the bandpass and high return loss in the stopband. Getting high selectivity at the bandpass edges and reduced size leads to look forward Chebyshev filters. Planar structures fabricated using print circuit technology are preferred for such filters for their low profile and cost [1]. A type of volumetric resonator exhaustively investigated is well-known as square open-loop resonator [2]. Several research work have been proposed modifications in this geometry in order to achieve miniaturization [3-4]. The rectangular waveguide filter is one of the iris-based solid geometries that exhibit good size reduction. This research study aims to synthesize a new class of Chebechev filters and provide new structure configurations that allow a pseudo-elliptical electromagnetic response based on advanced techniques already used for implementing filters with lumped elements in rectangular waveguides with inductive irises using HFSS and AWR software to finally develop a new dual-mode filter cavity. Analysis method applied for determining the filter

cavity dimensions and design the proposed structures is described in details with the objective of optimizing the filter selectivity using transmission zeros as suggests the pseudo-elliptical response. This paper presents a bandpass filter based on volumetric technology for X and Ku dual-band with a relative bandwidth of 2.5% ranging from 11.85GHz to 12.15GHz. The filters exhibit an insertion loss of 0.4/0.3dB and a return loss of 20/23dB for the whole bandwidth. This demonstrates good performance for the proposed designs.

II. EQUIVALENT CIRCUITS AND ANALYSIS

A narrowband three-pole dual-band rectangular waveguide filter is presented by the equivalent circuit shown in Fig. 1. The mutual inductance or coupling coefficient M_{ij} refers to the i^{th} and j^{th} resonator.

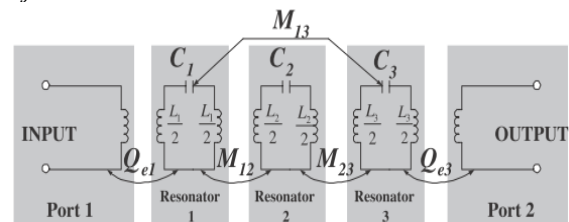

Fig.1. Equivalent circuit of 3rd pole bandpass rectangular wave guide filter

The cross coupling M_{13} determines the selectivity at a finite frequency. The external quality factors are denoted Q_{e1} and Q_{e3} at the input and output ports. The filter will have an attenuation pole at one side of the bandpass. It requires resonators to be asynchronously tuned to give an asymmetric filter frequency response. Thus, resonating frequency for each resonator may be different and must be chosen in a specific way that satisfy the filter requirements. The angular resonant frequency is given by [5]:

$$\omega_{0i} = \frac{1}{\sqrt{L_i C_i}} = 2\pi f_{0i} \quad \text{for } i=1,2,3 \quad (1)$$

Where L_i and C_i are the induction and capacitance values of the equivalent circuit. To keep the filter physical configuration symmetrical though the frequency response is asymmetric, the following assumptions are made [6]:

$$M_{12} = M_{23} \quad (2)$$

$$Q_{e1} = Q_{e3} \quad \text{and} \quad (3)$$

$$\omega_{01} = \omega_{03} \quad (4)$$

Figure 2 presents the lowpass prototype of the filter transformed from the equivalent circuit (figure 1). It employs J inverters with [7-8]:

$$J_{12} = J_{23} = 1 \quad (5)$$

This work was supported Laboratory Technology of Communication.

Damou Mehdi, Gouni Slimane are with Laboratory of Electronics, Signal Processing and Microwave and Laboratory Technology of Communication, Faculty of Technology University Tahar Moulay of Saida, Algeria (bouazzamehdi@yahoo.fr).

Chetioui Mohammed and Boudkhil Abdelhakim are with Laboratory of Telecommunications, Abu Bakr Belkaid University of Tlemcen



The proposed filter prototype is displayed in Fig. 2. Each resonator presents a frequency invariant is shown in Fig. 2. Each resonator represents an invariant frequency and J_{ij} are the characteristic admittance of the inverter. In order the studied case $J_{12} = J_{23} = 1$ along the main filter path, the bandpass inverter with admittance characteristic J_{13} accounts for cross coupling between adjacent resonators. g_i and B_i ($i = 1, 2, 3$) presents the capacitance and the frequency susceptance of the lowpass prototype, respectively. g_0 and g_4 present the resistive terminations at the input and output ports.

$$g_0 = g_4 \quad (6)$$

$$g_1 = g_3 \quad \text{and} \quad (7)$$

$$B_1 = B_3 \quad (8)$$

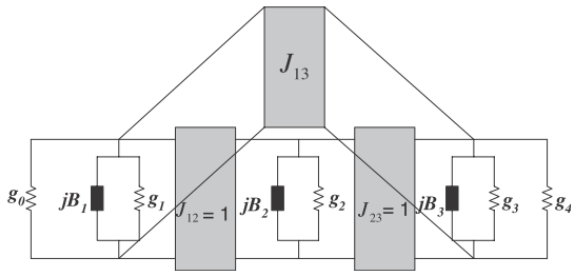

Fig. 2. Low pass prototype of the proposed filter

The unknown lowpass element values may be determined through a synthesis method [8] The unknown low pass element values may be determined by a synthesis method [9]. By using the lowpass to bandpass frequency transformation L_i and C_i can be solved as:

$$C_i = \frac{1}{\omega_0} \left(\frac{g_i}{FBW} + \frac{B_i}{2} \right) \quad (9)$$

$$L_i = \frac{1}{\omega_0} \left(\frac{g_i}{FBW} - \frac{B_i}{2} \right) \quad (10)$$

$$\omega_{0i} = \frac{1}{\sqrt{L_i C_i}} = \omega_0 \sqrt{1 - \frac{B_i}{g_i/FBW + B_i/2}} \quad (11)$$

Where ω_0 is the angular frequency in centre frequency, and ω_{0i} is the angular resonance frequency of i^{th} resonator. FBW presents the fractional bandwidth of the filter. Finally, to derive the expressions for the external quality factors and coupling coefficients, susceptance slope parameter of each shunt resonator (figure 1) can be defined as follows:

$$b_i = \omega_{0i} C_i = \frac{\omega_{0i}}{\omega_0} \left(\frac{g_i}{FBW} + \frac{B_i}{2} \right) \quad (12)$$

External quality factors Q_{ei} and Q_{en} and the coupling coefficient M_{ij} can be found by [8]:

$$Q_{e1} = \frac{b_1}{g_0} = \frac{\omega_{01}}{g_0 \omega_0} \left(\frac{g_1}{FBW} + \frac{B_1}{2} \right) \quad (13)$$

$$Q_{en} = \frac{b_n}{g_{n+1}} = \frac{\omega_{0n}}{g_{n+1} \omega_0} \left(\frac{g_n}{FBW} + \frac{B_n}{2} \right) \quad (14)$$

$$M_{ij/i \neq j} = \frac{J_{ij}}{\sqrt{b_i b_j}} \quad (15)$$

$$= \frac{\omega_0}{\sqrt{\omega_{0i} \omega_{0j}}} \frac{FBW \cdot J_{ij}}{\sqrt{\left(g_i + \frac{FBW \cdot B_i}{2} \right) \left(g_j + \frac{FBW \cdot B_j}{2} \right)}}$$

Where n is the n is the filter degree or the resonator number.

III. TRANSMISSION ZEROS CREATED BY SUPERIOR MODES

For some applications it is necessary to introduce transmission zeros near the filter bandwidth to increase its selectivity. First, current methods in literature used for creating such zeros are investigated before starting implementing new techniques used for developing such a type of filters: Creating transmission zeros in microwave filters can be achieved using different methods:

Introducing couplings between non-adjacent resonators is one of the main applied methods as developed in [7] [9] [10]. Accordingly, Cross-coupling using the extracted poles method presents another efficient method that permits creating transmission zeros. It consists of allowing signals two itineraries through the structure in a specific way in which waves will be canceled each one by the other for a particular frequency; a transmission zero is consequently created. Such a method is commonly used for circular waveguides whose resonators operate in dual mode. Transmission zeros can be created by coupling two orthogonal modes as it is currently used in satellite communication systems by input and output multiplexers (IMUX and OMUX). However, cross-coupling method suffers from strict limitations for the fact that the target structure requires at minimum three resonance cavities for one transmission zero that is expensive in cost and profile. In addition, machining circular waveguides is very delicate and requires high precision of the order of a micron. It is therefore very necessary to find an alternative solution to create zeros in a simple way. This can be obtained by using upper TE_{m0} propagation modes (with $m > 1$) that is brought to filter designing using rectangular waveguides. Upper modes are required to improve the filter electrical response and transmission zeros are can be easily obtained through coupling the fundamental mode TE_{10} to a specific upper mode TE_{m0} as it is already demonstrated by [9] [11].

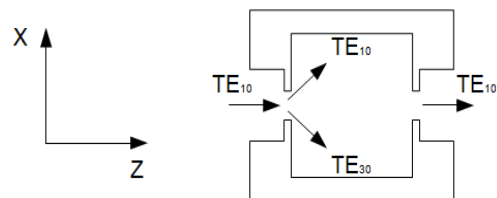

Fig.3. Dual-mode cavity

Figure 3 describes how a dual-mode rectangular waveguide operates [11] [12] [13] [14] consisting of the following elements: Two access guides (entrance and exit), a resonant cavities of a length equals to $\lambda g / 2$ and inductive irises for coupling adjacent cavities.

The proposed filter structures employ a standard WR technology using identical waveguides for entry and exit. Upper TE_{m0} propagation modes are evanescent. Modes' length mustn't allow the fundamental mode to resonate and must be less than the wavelength half and ensure at the end almost zero amplitude for the evanescent waves to avoid superfluous reflections from the first obstacle.

To the p th resonance of the TE_{mn} propagation mode corresponds a TE_{mnp} resonant mode. When the wave TE_{m0} ($n = 0$) is guided along a cavity of section $a > b$, its magnetic component along the z axis becomes:

$$H_z = H_0 \cos(m\pi x) e^{-j\beta z} \quad (16)$$

At the end of the resonator of length l , H is written as follows:

$$H_z = H_0 \cos(m\pi) e^{-j\beta l} \quad (17)$$

There is appearance of resonances for the particular frequencies f_p such as:

$$\beta l = p\pi \quad (18)$$

The propagation constant in a resonant cavity is given by:

$$k_c^2 + \frac{p^2\pi^2}{l^2} = \mu_0\epsilon_0 4\pi^2 f_p^2 \quad (19)$$

Frequencies are expressed using the celerity of light as:

$$f_p = \frac{c}{2} \sqrt{\frac{m^2}{a^2} + \frac{n^2}{b^2} + \frac{p^2}{l^2}} \quad c = \frac{1}{\sqrt{\mu_0\epsilon_0}} \quad (20)$$

μ_0 : vacuum magnetic permittivity

ϵ_0 : vacuum magnetic permeability

m, n, p : TE $_{mnp}$ mode indexes

c : light celerity

a, b : guide sections

l : resonant cavity length

p : resonances mode rank

IV. SINGLE MODE CAVITY

The section ($a \times b$) of the guide is standard. The length of the cavity is determined by the wavelength at the resonant frequency (frequency and dimensions of the cavities are linked). The resonators are calculated on the first resonance TE $_{101}$. The harmonics defined for p greater than or equal to 2 constitute spurious feedback. The section of the guide is fixed by the MR standards. The length is given from the previous equation.

$$l = p \sqrt{\frac{1}{4 \frac{f_0^2}{c^2} - \frac{m^2}{a^2} - \frac{n^2}{b^2}}} \quad (21)$$

By way of illustration, let's calculate the dimensions of a resonant cavity at 12 GHz.

mode indices	celerity	MR75	central frequency
$m=1$	$a=19.05$	$c=3.108\text{m/s}$	
$n=0$	$b=9.53$	$f=12\text{ GHz}$	
$p=1$			

We calculate the length of the resonant cavity: $l=16,56\text{ mm}$.

It is a half-wave (half-wavelength) cavity. We know that the irises separating each cavity have non-zero electrical lengths.

V. III. IMPLEMENTATION OF 3RD POLE BANDPASS FILTER

The first filter operates between X and Ku bands at 12 GHz. The zero transmission is here to the left of the bandwidth. This is generally more difficult to obtain than a zero located to the right of the strip. It is one degree higher than the first filter. The additional pole is provided by the addition of a single-mode resonant cavity on the TE $_{101}$ fundamental. For dual-band rectangular waveguide filter, the HP standard at 12 GHz is determined by the name MR75, the characteristics of which are as follows:

- ✓ Section of the MR75 guide: 19.05 mm \times 9.53 mm.
- ✓ Cutoff frequency: 7.88 GHz.
- ✓ Tolerance $\pm 7.6\ \mu\text{m}$.
- ✓ Frequency range: 10 - 15 GHz.

- ✓ Linear attenuation between 12.7 and 32.5 dB/100m $\rightarrow \approx 28.5\text{ dB/100m}$ at 12 GHz.

The specifications imposed for this first filter are as follows:

- ✓ Central frequency: 12 GHz
- ✓ Bandwidth: 300 MHz (2.5%): 11.85 - 12.15 GHz (Chebyshev frequencies).
- ✓ Losses by Ripple in the Band: 0.044 dB.
- ✓ Return losses in the band: 20 dB.
- ✓ Order: 3
- ✓ Transmission zero: 1 to 11.75 GHz (zero to the left).

Third order

The third order is the cascading of a dual-mode cavity and a single-mode cavity. It therefore allows only one zero for three poles. $n = 3$ and $n_{z\text{max}} = 1$

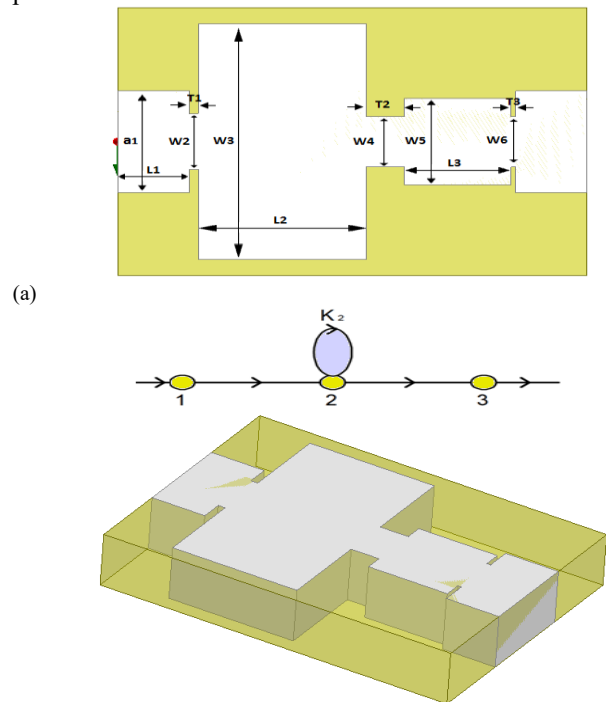

Fig. 4. Proposed 3rd pole bandpass rectangular waveguide cross coupled filter: (a) 2D, (b) 3D design

TABLE I
OPTIMIZED FILTER DIMENSIONS

Name	a_1	w_2	w_3	w_4	w_5	w_6
Value	19.04	10.4	44.01	9.32	16.05	9.35
Name	L_1	L_2	L_3	T_1	T_2	T_3
Value	10	23.6	14.95	1.3	5.3	0.69

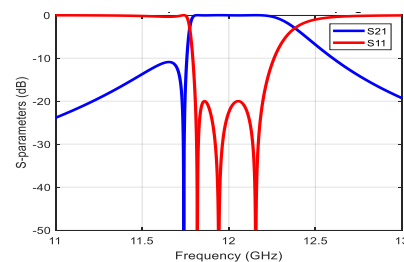

Fig.5. Ideal response of the 3rd pole bandpass rectangular waveguide cross coupled filter

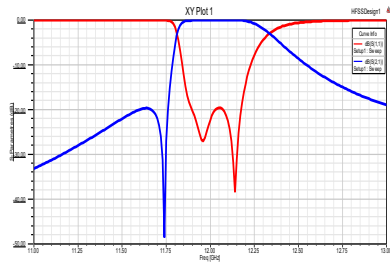

Fig. 6. Electromagnetic response of the 3rd pole bandpass rectangular waveguide cross coupled filter

The filter is gradually synthesized. It must start by simulating the first cavity: that is to say the first two resonators and zero. Guide calculates the dimensions of the two cavities to have zero at 11.75 GHz (dual mode cavity) and resonance at 12 GHz (single mode cavity). Zero is located as expected at 11.75 GHz and the poles are very apparent below this frequency. It is already know that it will be necessary to reduce the lengths of the cavities in order to increase the resonant frequencies. On the other hand, the zero is well placed: the width of the two-mode cavity is fixed. The pole appears much lower than expected. After several optimizations, the final dimensions of the filter are determined as shown in Table I.

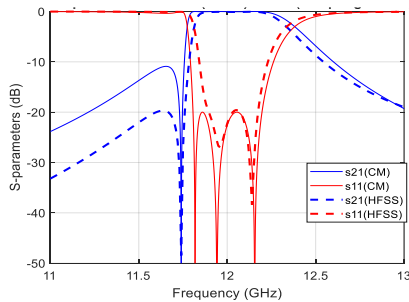

Fig. 7. Comparison of HFSS and CM responses of the 3rd pole bandpass rectangular waveguide cross coupled filter

The electric and magnetic fields at the surface of the rectangular waveguide filter at the different operating frequencies are illustrated in Fig. 8 and Fig. 9, respectively.

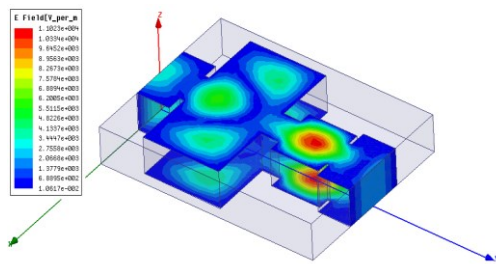

Fig. 8. Distribution of the electric field at 12 GHz

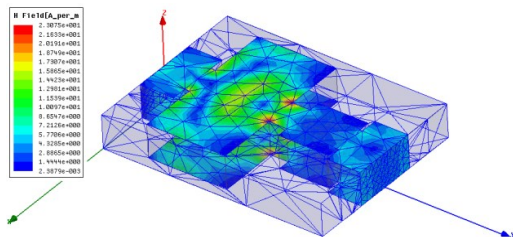

Fig. 9. Distribution of the magnetic field at 12 GHz

VI. IV. DESIGN AND IMPLEMENTATION OF FOUR POLE BAND PASS FILTER

The second filter operates also X and Ku bands at 12 GHz and the specifications with two zero transmission are displayed in as follows:

- ✓ Central frequency: 12 GHz.
- ✓ Bandwidth: 300 MHz (2.5%): 11.85 - 12.15 GHz.
- ✓ Losses by Ripple in the Band: - 0.044 dB.
- ✓ Return losses in the band: 20 dB.
- ✓ Order: 4
- ✓ Transmission zero: 1 to 11.75 GHz (zero to the left).

The 4th pole rectangular waveguide cross coupled filter is designed to be simulated using a copper metallization on a substrate with a relative dielectric constant of 1.

Fourth order

Two dual-mode cavities produce four poles and two transmission zeros. These can be arranged to the right or to the left of the passband or even on each side of the latter, for a symmetrical response or not. $n = 4$ and $n_{zmax} = 2$.

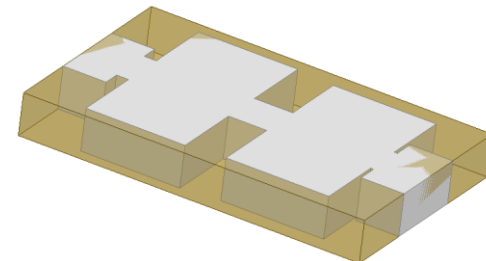
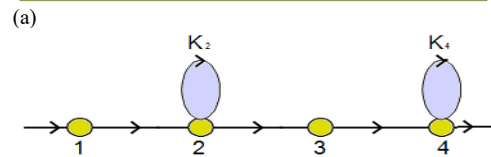
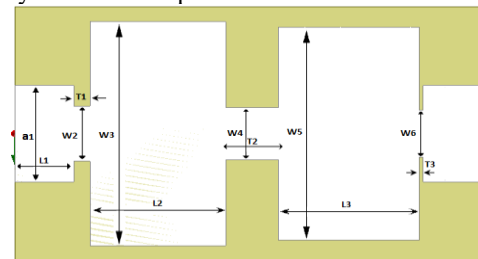

Fig. 10. Proposed 4th pole bandpass rectangular waveguide cross coupled filter: (a) 2D, (b) 3D design

TABLE II
OPTIMIZED FILTER DIMENSIONS

Name	a ₁	w ₂	w ₃	w ₄	w ₅	w ₆
Value	19.05	10.84	44.1	10.2	41.96	9.3
Name	L ₁	L ₂	L ₃	T ₁	T ₂	T ₃
Value	10	23.09	23.96	2.8	8.92	0.7

Based on the centre frequency and required fractional bandwidth, the element values of the lowpass prototype g_0, g_1, g_2, g_3, g_4 and g_5 are founded as:

$$g_1 = 0.9314, g_2 = 1.2920, g_3 = 1.5775$$

$$g_4 = 0.7628, g_5 = 1.2210, J_{12} = J_{34} = 1.0$$

The filter coupling matrix and scaled denormalized external quality factors can be calculated using the following formulas [3]:

$$m = \begin{bmatrix} 0 & 0.93 & 0 & 0 & 0 & 0 \\ 0.93 & 0 & 0.91 & 0 & 0.18 & 0 \\ 0 & 0.91 & 0 & 0.7 & 0 & 0 \\ 0 & 0 & 0.70 & 0 & 0.91 & 0 \\ 0 & 0.18 & 0 & 0.91 & 0 & 0.93 \\ 0 & 0 & 0 & 0 & 0.93 & 0 \end{bmatrix}$$

External quality factor;

$$Q_{es} = \frac{g_0 g_1}{FBW} = \frac{0.9314}{0.038} = 37.25$$

Q_e	M_{12}	M_{23}	M_{34}	M_{14}	Q_s
37.25	0.0228	0.0175	0.0228	0.0046	37.25

In this section, 4-Resonator filter with tow FTZ is designed and simulated. The circuit will be synthesized in AWR as distributed element bandpass filter.

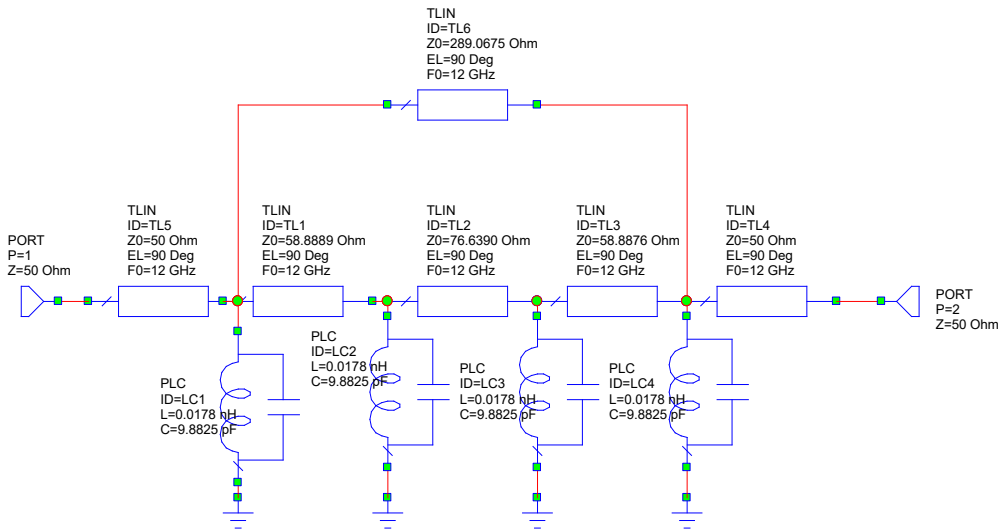

Fig. 11. Equivalent circuit of lumped element for the proposed 4th pole bandpass rectangular waveguide cross coupled filter in AWR

As shown in Fig.12 the theoretical frequency response of the filter resonates at 12GHz. so the resultant insertion and return losses derived from AWR design is given in Fig. 11. Both FTZs are visible in the frequency response. One FTZ is located at about 11.75 GHz and the other is located at about 12.25GHz. The filter has very good rejection for both upper and lower stopbands.

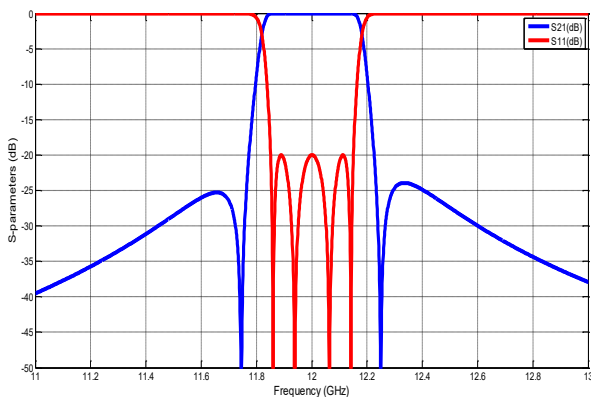

Fig. 12. Ideal response (CM) of the proposed 4th pole bandpass rectangular waveguide cross coupled filter

Fig.13 displays simulated response when implementing the filter structure for a bandpass of more than 12 GHz from 11.85 GHz 12.15 GHz. The distances between the resonators are further tuned and the final response of the bandpass filter including the input and return losses is shown in Fig. 12.

Fig. 14 shows the response of the EM model of the designed filter in comparison with the response of the distributed model.

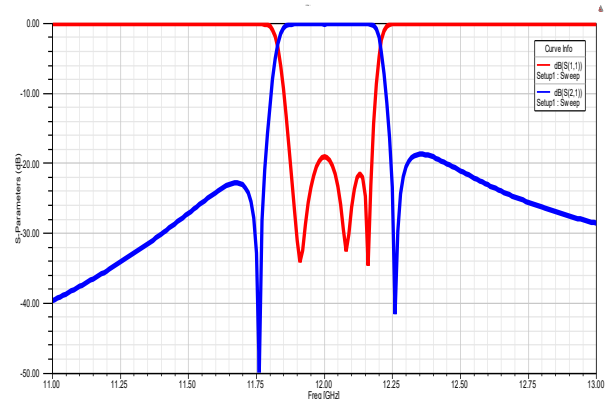

Fig. 13. Simulated (HFSS) response of the proposed 4th pole bandpass rectangular waveguide cross coupled filter

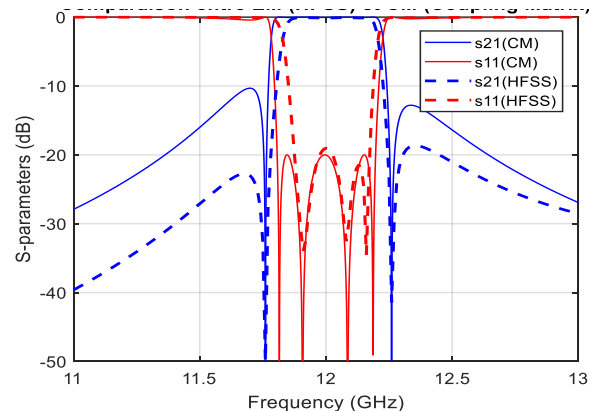

Fig. 14. Comparison of HFSS and CM responses of the proposed 4th pole bandpass rectangular waveguide cross coupled filter

Excellent agreement between ideal and simulated responses is achieved. The insertion loss is about 0.3dB and return loss is around 23dB for the cross-coupled waveguide filter. As expected, two transmission zeros on the right and left side of the band is observed at 11.85 GHz and 12.15 GHz respectively with an out-of-band rejection of more than 25 dB at this point. The simulations of E-field and H-field on the structure were performed. The simulation results are shown in Figures 15 and 16, where the E-field has significant impact on the rectangular section of structure at all resonance frequencies, while the H-field has very small impact.

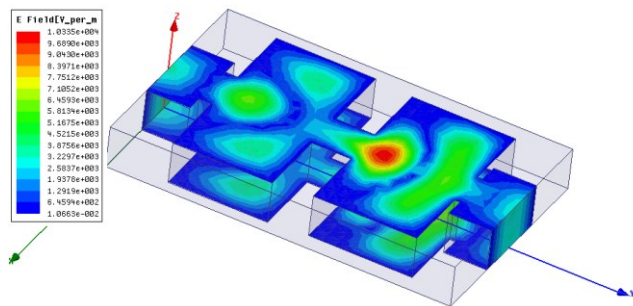

Fig. 15. Distribution of the electric field at 12GHz

In the first cavity, it is clearly observed that two electric field maxima of the second harmonic TE_{102} are created. At the same time where a third electric field maxima of the TE_{301} is created in the second cavity. The coupling between the two modes is controlled by waveguide dimensions a and l that fixes the transmission zero position.

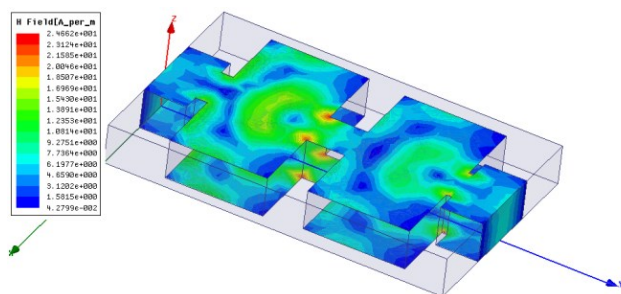

Fig. 16. Distribution of the magnetic field at 12GHz

VII. V. CONCLUSION

This paper presents two high performance designs of a 3rd and 4th pole rectangular waveguide cross coupled filter based on direct coupled technique resonating at 12 GHz. Excellent agreements between theoretical response (CM) and simulation results (HFSS) for the proposed topologies of the filter is obtained due to efficient electromagnetic optimization technique. The filter structures exhibit an insertion loss of 0.4/0.3dB and return loss of 20/23dB for the 3rd pole and 4th pole topology respectively for a bandwidth ranging from 11.85GHz to 12.15GHz. This demonstrates good electromagnetic responses for the designed filter and high efficiency of the implemented technique. These types of structures are relatively easy to be realized without resorting

to tune elements. Such a type of filters is widely recommended for wireless communication systems especially for satellite repeaters.

REFERENCES

- [1] J. Hong and M. J. Lancaster, *Microstrip filters for RF/Microwave applications*, New York: Wiley, 2011.
- [2] J. S. Hong and M. J. Lancaster, "Theory and Experiment of Novel Microstrip Slow-Wave Open-Loop Resonator Filters," *IEEE Trans. Microwave and Techniques*, vol. 45, no. 12, pp. 2358-2365, Dec. 1997.
- [3] R. J. Cameron, C. M. Kudsia, and R. R. Mansour, *Microwave Filters for Communication System*, (John Wiley & Sons, Inc., 2018).
- [4] FEST3D 6.8.4 Aurora Software and Testing, S.L. (on behalf of ESA/ESTEC), Valencia, Spain, 2013. Available: www.fest3d.com.
- [5] E.Hanna, P.Jarry, E.Kerhervé and J.M.Pharm, "General Prototype Network With Cross coupling Synthesis Method For Microwave Filters-Application to suspended substrate filters", *Int. Workshop on Microwave Filters*, 13-15 Sep.2004, CNES, Toulouse, France.
- [6] Mehdi Damou, Keltouma Nouri, Mohammed Feham and Mohammed Chetoui "Design and Optimization of Rectangular Waveguide Filter based on Direct Coupled Resonators » *Journal of Electronics and Telecommunications*, 2017, VOL. 63, NO. 4, PP.375-380. <http://doi.org/10.1515/eletel-2017-0051>
- [7] Xiaobang Shang, Wenlin Xia, and Michael J Lancaster. "The design of waveguide filters based on cross-coupled resonators. *Microwave and Optical Technology Letters*, 56(1):3–8,2014. <https://doi.org/10.1002/mop.27989>
- [8] S. Cogollos, M. Brumos, V.E. Boria, C. Vicente, J. Gil, B. Gimeno, and M. Guglielmi. A systematic design procedure of classical dual-mode circular waveguide filters using an equivalent distributed model. In *Microwave Theory and Techniques*, *IEEE Transactions on*, volume 60, pages 1006–1017, April 2012. <https://doi.org/10.1109/TMTT.2013.2252920>
- [9] Hershtig, R., R. Levy, and K. Zaki, "Synthesis and design of cas-caded trisection (CT) dielectric resonator filters," *Proceedings of European Microwave Conference*, 784–791, Jerusalem, September 1997.
- [10] O. Roquebrun, M. Guglielmi, P. Jarry, J. M. Pharm et E. Kerhervé, "Nouvelles Structures de Filtrés Microondes Bimodes", *12 Journées Nationales Microondes JNM'01 - Poitiers - France*, 16-18 mai 2001
- [11] O. Roquebrun, P. Jarry, E. Kerhervé et M. Guglielmi, "Filtrés en Ligne avec des Zéros de Transmission - Circuit Equivalent Distribué", *Rapport final du marché réf. XRM/069.97/MG*, avril 1999.
- [12] M. Guglielmi, P. Jarry, E. Kerherve, O. Roquebrun, D.Schmitt, "Direct EM Design of a New Class of Dual Mode Filters", *Workshop IEEE International Microwave Symposium IMS'2001- Phoeni# - USA*, 20-25 May 2001
- [13] M. Guglielmi, O. Roquebrun, P. Jarry, E. Kerherve, M. Capurso and M. Piloni, "Low-Cost Dual-Mode Asymmetric Filters in Rectangular Waveguide", *IMS 2001 - Phoeni# - USA*, 20-25 May 2001. <https://doi.org/10.1109/MWSYM.2001.967253>
- [14] M. Guglielmi, F. Montauti, L. Pellegrini and P. Arcioni, "Implementing Transmission Zeros in Inductive-Window Bandpass Filters", *IEEE-MTT*, vol. 43, n° 8, pp. 1911-1915, August 1995. <https://doi.org/10.1109/22.402281>