

Modified current differencing transconductance amplifier – new versatile active element

A. MALCHER*

Institute of Electronics, Silesian University of Technology, 16 Akademicka St., 44-100 Gliwice, Poland

Abstract. This paper introduces a new current mode component called Modified Current Differencing Transconductance Amplifier (MCDTA). Important parameters of the circuit i.e. input resistance, z terminal resistance and transconductance of the output stage can be tuned electrically. The circuit can be implemented in linear and non-linear analog signal processing. The paper presents an example of the MCDTA application – a complete quadrature oscillator with the amplitude regulation. The functionality of the example circuit and its tuning capability were proved by the SPICE simulation results.

Key words: current differencing transconductance amplifier, quadrature oscillator, amplitude regulation, current-mode operational amplifier, continuous time field programmable analog array.

1. Introduction

Recently, an increasing number of analog circuits working in a current mode has been observed. The growing interest in current mode analog circuits is caused by the effort to reduce the supply voltage of the devices – especially important in portable and battery powered equipment. The bandwidth obtained for current mode circuits is usually higher than for voltage mode circuits created in the same technology.

Modern topologies of current mode active circuits – e.g. current conveyors (CC), current feedback amplifiers (CFA), operational transconductance amplifiers (OTA) and many others – can be considered as examples of this trend. There are also research works (e.g. [1]) on a true current operational amplifier (COA) working as a current controlled current source (CCCS) with a differential current input and large current gain. This circuit allows transforming the well known structures based on the voltage operational amplifiers (VOA) into the current mode. Moreover, there can be found very special current mode circuits, like a CMOS neuron cell designed for an adaptive hardware neural network [2].

Some of the current mode analog active circuits have a very interesting feature – their parameters, like gains or resistances can be tuned by the electrical signals (bias voltages or currents). This is promising for the idea of building a continuous time Field Programmable Analog Array (FPAA) based on current mode active elements. Nowadays, most of the commercially available FPAA circuits like dpASP circuits from the Anadigm [3] or PSoC from the Cypress [4] work on the discrete time principle – switched capacitor (SC) technique. The application designer must consider their limitations typical for the sampling systems – e.g. Nyquist frequency and the need of the anti-aliasing filters. In continuous time FPAA there are no such limitations.

For the last few years there have appeared numerous papers on a new element called Current Differencing Transconductance Amplifier (CDTA) [5–11]. This element, connected with some external passive components, makes it possible to build many important applications like amplifiers, filters, oscillators and others. Hence this circuit seems to be a good candidate for the basic building block of the future continuous time FPAA.

The basic functional schematic of the CDTA circuit is presented in Fig. 1.

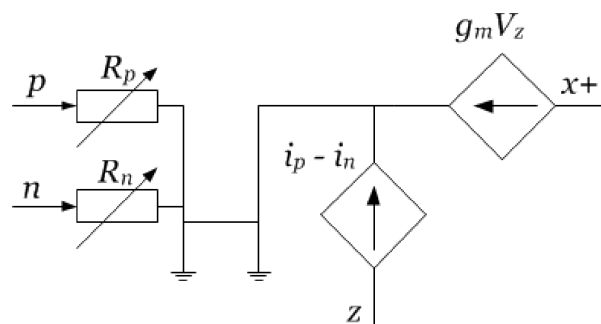

Fig. 1. CDTA equivalent circuit

The circuit consists of a current source controlled by the difference of the input currents (terminal z) and the transconductance amplifier controlled by the potential of the z terminal. The voltages and currents of the circuit are described by Eq. (1).

$$\begin{bmatrix} V_p \\ V_n \\ I_z \\ I_x \end{bmatrix} = \begin{bmatrix} R_p & 0 & 0 & 0 \\ 0 & R_n & 0 & 0 \\ 1 & -1 & 0 & 0 \\ 0 & 0 & \pm g_m & 0 \end{bmatrix} \cdot \begin{bmatrix} I_p \\ I_n \\ V_z \\ V_x \end{bmatrix} \quad (1)$$

*e-mail: amalcher@polsl.pl

There can be found many modifications of this structure in the literature – for example duplication of the z terminal is discussed in [6, 8], implementation of two transconductance amplifiers – in [6], replacement of the OTA with the voltage follower – in [12], and replacement of the current differencing stage with the current buffer – in [10].

The aim of this paper is to present a new element based on the CDTA circuit described above. Several modifications introduced to the basic structure improved the versatility of the element and made it possible to build numerous new current mode linear and non linear circuits. The introduced modifications caused only a moderate increase of the circuit complexity.

The paper contains the analysis of the circuit characteristics and a collection of its possible applications. The diversity of applications, small number of external elements required in these applications and the possibility of electrical tuning make the presented element suitable for building a continuous time field programmable analog array.

2. Proposed modifications of the basic structure of CDTA

In order to obtain a more versatile active element the following modifications of the basic CDTA structure can be introduced:

- replacing the grounded reference potential node of the current differencing stage by an additional terminal y ;
- implementation of the transconductance amplifier as a differential output circuit with the possibility of duplicating its current outputs;
- connecting an additional current controlled resistor R_z between the z terminal and the ground.

The resulting circuit is called here the Modified Current Differencing Transconductance Amplifier (MCDTA). The equivalent schematic of the circuit is presented in Fig. 2.

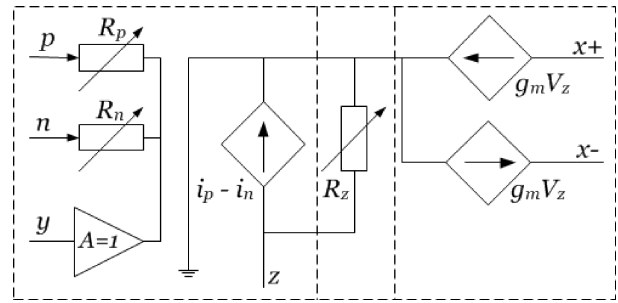

Fig. 2. MCDTA equivalent circuit

The voltages and currents of the circuit are interrelated according to Eq. (1).

$$\begin{bmatrix} V_p \\ V_n \\ I_z \\ I_{x+} \\ I_{x-} \end{bmatrix} = \begin{bmatrix} R_p & 0 & 1 & 0 \\ 0 & R_n & 1 & 0 \\ 1 & -1 & 0 & 1/R_z \\ 0 & 0 & 0 & g_m \\ 0 & 0 & 0 & -g_m \end{bmatrix} \cdot \begin{bmatrix} I_p \\ I_n \\ V_y \\ V_z \end{bmatrix} \quad (2)$$

The CMOS implementation of this circuit is presented in Fig. 3.

The circuit was simulated in LT SPICE IV environment. The implemented MOS transistor models were taken from the T97R process published by the MOSIS company [13]. This process is commercially available for prototyping purposes – especially for the LSI circuits. The models are presented in Appendix A.

The transfer characteristics of the PMOS and NMOS transistors with equal dimensions are not symmetrical. To obtain complementary transistors, different W/L ratios must be used for PMOS and NMOS. The transistor dimensions are presented in Table 1.

Table 1
Transistor dimensions used in the MCDTA circuit

Tran.	M43, M44	Other NMOS	Other PMOS
W [μ]	30	10	30
L [μ]	1.2	1.2	1.2

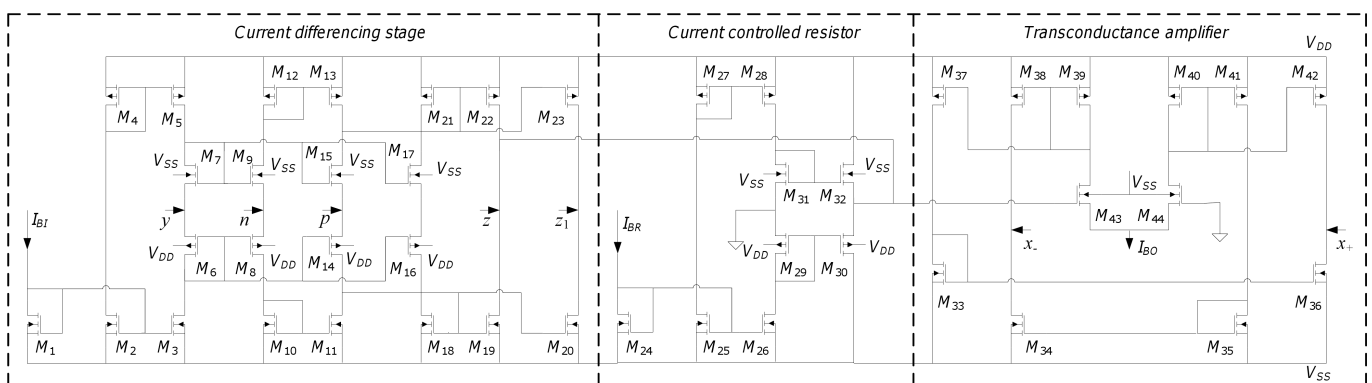

Fig. 3. MCDTA circuit – CMOS implementation

Modified current differencing transconductance amplifier...

The circuit was simulated with the supply voltage of ± 5 V.

The current differencing input stage is similar to the one presented in [6] by Siripruchyanun and Jaikla, except for the additional voltage input terminal y known from Current Conveyor circuits. This input allows the use of the MCDTA as a positive Current Conveyor CCII₊ (using p , y and z terminals) or as a negative Current Conveyor CCII₋ (using n , y and z terminals). The M_{20} and M_{23} transistors were added to allow the duplication of the current output. If still another current output is needed, an additional pair of transistors can be implemented.

The input resistances are electrically controllable. That feature is to be analyzed in the subsequent paragraphs.

The second stage is the current controlled resistor. It is connected between the z terminal and the ground. If the application does not require this resistor, it can be switched off by setting the bias current I_{BR} to 0.

The third stage of the circuit is a transconductance amplifier with the symmetrical output. The first input of the OTA (gate of M_{43} transistor) is connected to the z terminal, while the second one (gate of M_{44} transistor) is grounded. The current outputs can be duplicated by connecting additional pairs of transistors in parallel to M_{36} , M_{42} (noninverting output) and M_{34} , M_{48} (inverting output). The transconductance value can be tuned by the bias current I_{BO} . The OTA circuit is very similar to the solution described by Keskin and Biolek in [9].

A very similar MCDTA circuit, but in bipolar implementation, was presented by the author in [14].

The proposed symbol of the MCDTA circuit is shown in Fig. 4.

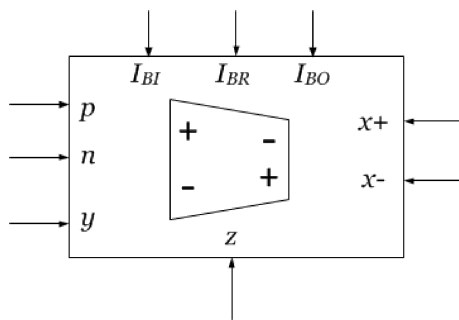

Fig. 4. MCDTA symbol

2.1. Static characteristics of the input stage. To analyze the input resistance of the p and n terminals we used the simplified model of the MOS transistor given by (3):

$$I_D = \frac{\beta}{2} \cdot (U_{GS} - V_{TH})^2, \quad (3)$$

where β – parameter dependent on the transistor geometry (W/L ratio) and the technological parameters; U_{GS} – voltage between the transistor gate and source terminals; V_{TH} – threshold voltage (technological parameter).

The forward transconductance of a MOS transistor equals:

$$g_{mt} = \sqrt{2\beta \cdot I_D}. \quad (4)$$

In the ideal case the small-signal input resistance of the p terminal R_p can be expressed as:

$$R_p = \frac{1}{g_{m14} + g_{m15}} = \frac{1}{\sqrt{8\beta \cdot I_{BI}}}, \quad (5)$$

where g_{m14} – transconductance of the M_{14} transistor; g_{m15} – transconductance of the M_{15} transistor; I_{BI} – first stage bias current value.

Formula (5) shows that the input resistance of the p terminal is inversely proportional to the square root of the bias current value. The input resistance of the n terminal is identical.

The input stage was simulated in the LT SPICE environment. The input characteristics were calculated for three values of the bias currents. The obtained results are shown in Fig. 5.

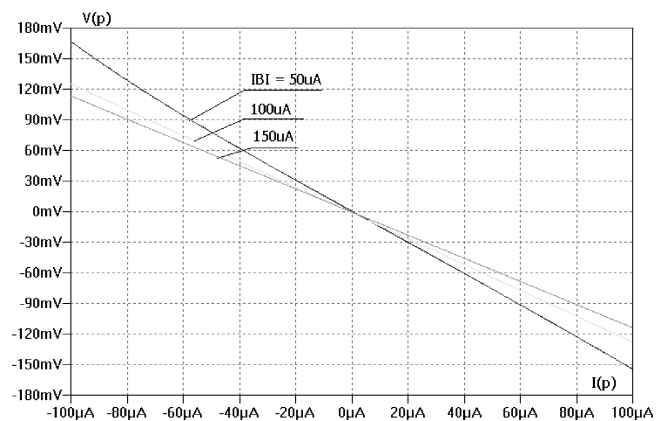

Fig. 5. MCDTA terminal p input characteristics

As it can be noticed, the input characteristics are almost linear and the input resistance decreases for the higher bias current values.

The next graph shows the input conductance (inverse of input resistance) versus bias current value.

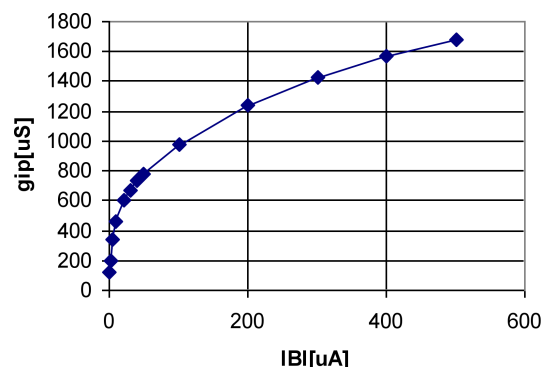

Fig. 6. MCDTA terminal p input conductance vs. bias current I_{BI}

The simulation results show that the input resistance can be controlled by the bias current, however, the range of its changes is not large. Tuning of the I_{BI} value from $1 \mu\text{A}$ to $500 \mu\text{A}$ corresponds to the input resistance changing in the range of $8.228 \text{ k}\Omega$ to $0.595 \text{ k}\Omega$. The result is much worse

than in bipolar implementation of the MCDTA [14], where the characteristics of the input conductance vs. bias current are linear and the range of resistance value changes is much wider.

The current gain of the input stage – ratio of the z terminal current to $(i_p - i_n)$ input currents difference – was changing between 0.98 and 1.04, so the dispersion was less than 5%.

2.2. Static characteristics of the current controlled resistor. The current controlled resistor connected to the z terminal had its characteristics nearly identical to the ones obtained for the p and n terminals. After switching the I_{BR} bias current off the equivalent resistance of the resistor was as high as about 160 k Ω .

2.3. Characteristics of the transconductance amplifier. The transconductance of the ideal MOS differential amplifier is given by:

$$g_m = \sqrt{\beta_D \cdot I_{BO}}, \quad (6)$$

where I_{BO} – differential pair bias current, β_D – beta parameter of the transistors in the differential stage (M_{43} , M_{44}).

It is significantly lower than the input conductance of the p and n terminals corresponding to identical bias current value. In order to obtain similar values of the OTA transconductance and input conductances, larger W/L ratio was used for the M_{43} , M_{44} transistors forming the differential pair.

The transfer characteristics of the differential amplifier are shown in Fig. 7.

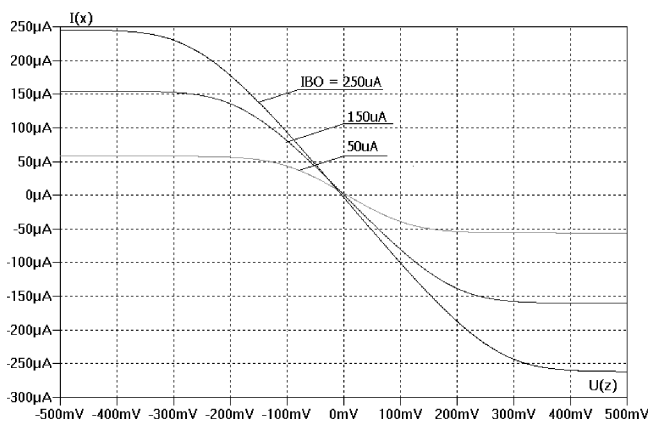

Fig. 7. Transconductance stage – transfer characteristics

The saturation effect typical for the differential amplifiers can be noticed here. (The maximum attainable output current is equal to the bias current of the differential pair I_{BO}).

Figure 8 shows the relationship between the OTA transconductance and the bias current value I_{BO} .

The simulation results confirm the theoretical relation (6).

Tuning the I_{BO} in the range from 1 μA to 500 μA corresponds to the transconductance changing in the range of 32 μS to 1.324 mS.

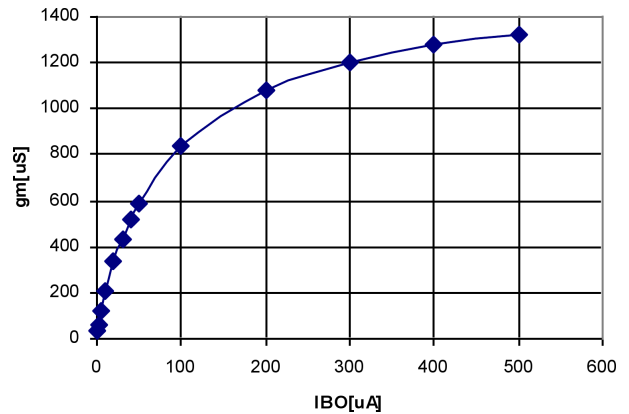

Fig. 8. OTA stage – forward transconductance vs. bias current

Hence again, the span of the transconductance changes is found smaller than the one obtained in bipolar implementation, where the relation between the transconductance and the bias current value is linear [14].

2.4. Frequency response of the MCDTA. The corner frequency of the MCDTA circuit was calculated for all bias currents (I_{BI} , I_{BR} and I_{BO}) set to 100 μA . The input sine-wave current was supplied to the p terminal, while the n terminal was left open. The current gain from the p to x terminals was found equal to 0.819 and the 3 dB bandwidth was equal to 72 MHz.

3. Open loop applications of the MCDTA circuit

The MCDTA alone, with no external elements, can be used to perform some operations or to substitute for known active current mode elements.

3.1. Current adder/subtractor. The input stage of the MCDTA can be used as an adding/subtracting circuit for the current signals – Fig. 9.

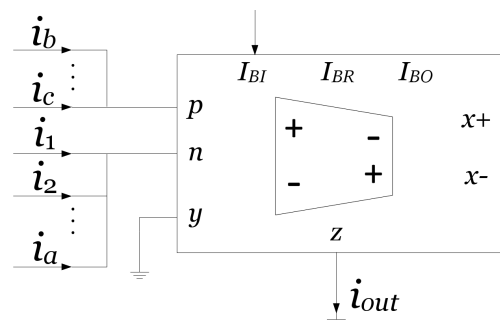

Fig. 9. MCDTA based current mode adder/subtractor

The output current i_{out} equals:

$$i_{out} = (i_1 + i_2 + \dots + i_a) - (i_b + \dots + i_c). \quad (7)$$

Special cases are:

1. the current follower – p terminal open, input current supplied to n terminal.
2. the current inverter – n terminal open, input current supplied to p terminal.

3.2. Second generation current conveyor. The input stage of the MCDTA circuit can work as a replacement of the $CCII_+$ and $CCII_-$ described in [15] – see Fig. 10.

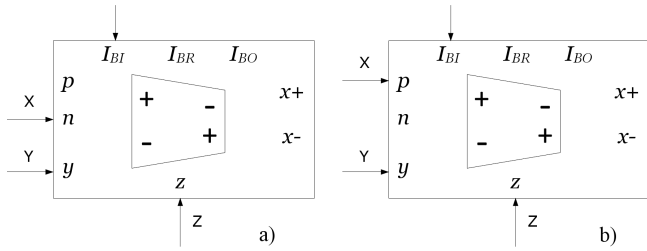

Fig. 10. Second generation current conveyor realizations based on MCDTA: a) $CCII_-$, b) $CCII_+$

3.3. Current controlled CDTA. The MCDTA can be used in all applications that require a basic CDTA circuit. In such applications terminal y has to be grounded and terminal I_{BR} has to be left open (while the z terminal resistor has to be switched off) – see Fig. 11.

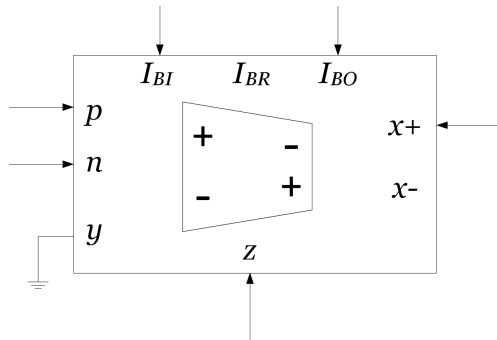

Fig. 11. MCDTA circuit as a replacement of the basic CDTA circuit

3.4. Transconductance amplifier. The third stage of the MCDTA circuit can be used separately as a differential output transconductance amplifier. The control currents I_{BI} and I_{BR} should be switched off and the transconductance can be then controlled by the I_{BO} current according to (6) – see Fig. 12. The input voltage should be supplied to the z terminal.

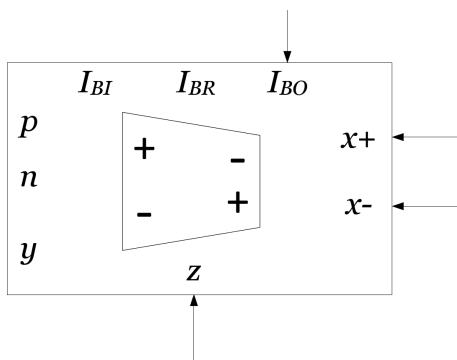

Fig. 12. MCDTA circuit as a differential output current controlled transconductance amplifier

The input stage of the MCDTA can also work as a voltage controlled current source – see Fig. 13.

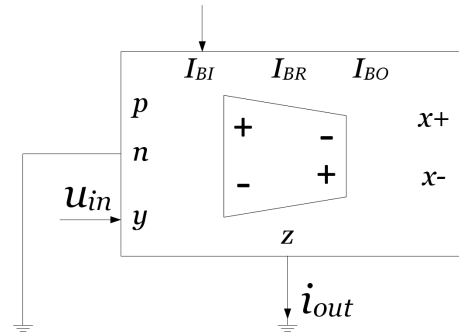

Fig. 13. The input stage of MCDTA circuit used as a voltage controlled current source (VCCS)

The y terminal works as the voltage input and the input resistance of the n terminal converts the input voltage into the current value. The output current i_{out} equals:

$$i_{out} = u_{in}/R_n = u_{in} \cdot \sqrt{8\beta \cdot I_{BI}}. \quad (8)$$

The transconductance of the circuit is proportional to the square root of the input bias current value I_{BI} .

3.5. Voltage follower. The MCDTA circuit is intended to work in the current mode, however, the input stage can also be used as a voltage follower – see Fig. 14.

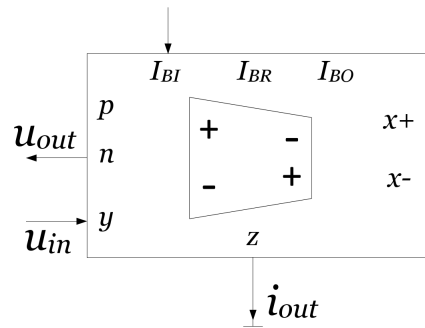

Fig. 14. MCDTA circuit as a voltage follower with the output current value tracking function

The output resistance of the follower can be controlled by the I_{BI} current. Additionally, the n terminal output current value can be tracked at the z terminal as the i_{out} current.

4. MCDTA circuit as a current mode operational amplifier

Figure 15 presents the functional schematic of the MCDTA with grounded voltage input y .

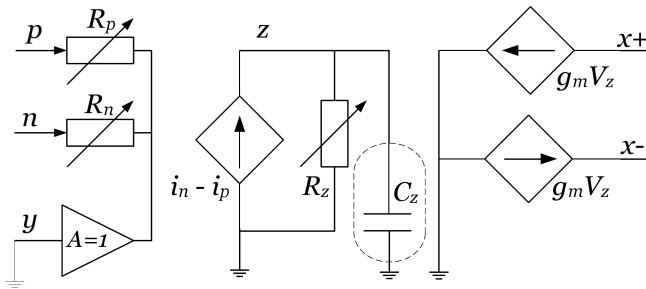

Fig. 15. MCDTA circuit as a current mode amplifier

The z terminal voltage equals:

$$V_z = (i_n - i_p)R_z. \quad (9)$$

The output current value is given by:

$$i_x = g_m V_z = (i_n - i_p)R_z g_m. \quad (10)$$

Equation (10) shows that the MCDTA circuit works as the fully differential current amplifier. The output current value is proportional to the difference between the input currents. The current gain is equal to:

$$B = i_x / (i_n - i_p) = R_z g_m = \frac{\sqrt{\beta_D \cdot I_{BO}}}{\sqrt{8\beta \cdot I_{BR}}}. \quad (11)$$

Hence the current gain depends on the ratio of the control currents I_{BO} and I_{BR} as well as on the geometrical parameters W/L of the transistors in the differential pair (β_D) and of the remaining transistors (β).

An additional grounded capacitor C_z connected to the z terminal provides the low pass filtering feature. It can be implemented as an external capacitor or its role can be played by the parasitic capacitance of the circuit. The transfer function is given by (12):

$$B(s) = \frac{R_z \cdot g_m}{1 + s \cdot R_z C_z}. \quad (12)$$

It corresponds to the corner frequency:

$$f_c = \frac{1}{2\pi R_z C_z}. \quad (13)$$

The corner frequency f_c can be tuned by means of I_{BR} changes, however, there is an interaction – the gain changes together with the corner frequency.

For the R_z resistance rising to infinity (at the I_{BR} current switched off) the open loop transfer function is given by (14) and the circuit works as a current integrator.

$$B(s) = \frac{g_m}{s \cdot C_z}. \quad (14)$$

We can see that in such a case the DC gain rises to infinity and the gain-bandwidth-product (the frequency for which the gain falls to the value of 1) is equal to:

$$f_T = \frac{g_m}{2\pi C_z}. \quad (15)$$

The f_T parameter can be controlled by the changes of I_{BO} current value, which can be very useful in frequency compensation of the closed loop circuits.

Equations (12) and (14) look very similar to the equations that describe the functioning of a voltage mode operational amplifier considered at different levels of idealization. It is the proof that the proposed circuit of MCDTA can work as a current mode operational amplifier presented in [1].

4.1. Voltage mode to current mode circuit transformation.

There are numerous and commonly known closed loop applications of the voltage mode operational amplifier like inverting and non-inverting amplifiers, first order and second order active filters, oscillators and others. There are also similar circuits using current mode operational amplifiers. Some of them are presented in [1].

The similarity between current mode circuits and voltage mode circuits was noticed for the first time by prof. T. Zagajewski [16]. This property was called there “duality of circuits”. The extension of this idea was presented by Roberts and Sedra in [17] and was called “adjoint transformation”. They say:

“... Replace the input voltage source by a short circuit and call the current flowing through it the new output response variable. Next, connect a current source to the output port of the original circuit. This is the new input, and the transfer function of this “adjoint circuit” is the ratio of two currents. Finally, replace each voltage-controlled voltage source (VCVS) by a current controlled current source (CCCS) with the same gain. The input terminals of the CCCS should be connected to the output port of the VCVS and, conversely, the output port of the CCCS is connected to the input port of the VCVS. The resistors and capacitors are left unchanged. The result is an alternate circuit with the exact same transfer function even though the nature of input and output variables are different” [17].

Application of this general principle for a simple voltage mode circuit containing classical voltage mode op-amps (VOA) and the network of passive elements takes the form of “the rule of thumb” algorithm. It allows transforming the voltage mode circuit into its current mode equivalent containing the current mode op-amp (COA), where:

- VOA inverting input becomes inverting output of the replacement COA;
- VOA non-inverting input becomes non-inverting output of the replacement COA;
- VOA output becomes the p input of the COA
- In case of fully-differential VOA (with the symmetrical output) its inverting output becomes the COA n input.

The presented transformation can be illustrated with two simple examples – the voltage follower and the non-inverting amplifier – see Table 2. The A parameter is the open loop voltage gain of the VOA and B is the open loop current gain of the COA. The other parameters of the VOA and COA are assumed ideal.

The formulae presented in Table 2 show that the gains of voltage mode circuits and current mode circuits obtained as a result of the adjoint transformation are fully symmetrical.

Modified current differencing transconductance amplifier...

Table 2

Voltage mode to current mode transformation examples

Voltage mode circuits	Current mode circuits
<p>Voltage follower</p>	<p>Current follower</p>
<p>Voltage gain – ideal case ($A \rightarrow \infty$):</p> $K_u = \frac{u_{out}}{u_{in}} = 1$	<p>Current gain – ideal case ($B \rightarrow \infty$):</p> $K_i = \frac{i_{out}}{i_{in}} = 1$
<p>Voltage gain – real case</p> $K_u = \frac{A}{A+1}$	<p>Current gain – real case</p> $K_i = \frac{B}{B+1}$
<p>Voltage mode non-inverting amplifier</p>	<p>Current mode non-inverting amplifier</p>
<p>Voltage gain – ideal case ($A \rightarrow \infty$):</p> $K_u = \frac{u_{out}}{u_{in}} = 1 + \frac{R_2}{R_1}$	<p>Current gain – ideal case ($B \rightarrow \infty$):</p> $K_i = \frac{i_{out}}{i_{in}} = 1 + \frac{R_2}{R_1}$
<p>Voltage gain – real case</p> $K_u = \frac{A(R_1 + R_2)}{(A+1)R_1 + R_2}$	<p>Current gain – real case</p> $K_i = \frac{B(R_1 + R_2)}{(B+1)R_1 + R_2}$

However, there can be found current mode circuits using fully differential COA that do not have their direct, commonly used voltage mode counterparts. An example of these circuits is presented in Fig. 16.

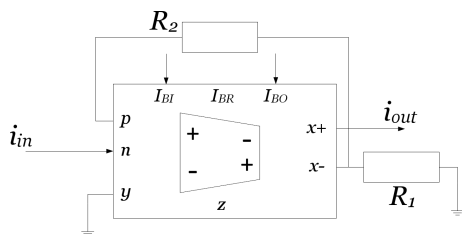

Fig. 16. Inverting current amplifier

The transfer function of the circuit presented in Fig. 16 in the ideal case (for $B \rightarrow \infty$) is given by:

$$K_i = \frac{i_{out}}{i_{in}} = - \left(1 + \frac{R_2}{R_1} \right). \tag{16}$$

The non-ideal current transfer function is:

$$K_i = - \frac{B(R_1 + R_2)}{(B+1)R_1 + R_2}. \tag{17}$$

Another example of a closed loop application of the fully differential MCDTA as a COA is the precision current inverter – see Fig. 17.

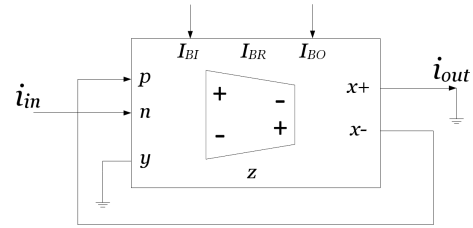

Fig. 17. Precision closed loop current inverter

In the ideal case the current gain of the circuit is equal to -1 .

The frequency limitations and the stability problems in closed loop current mode circuits are very similar to the problems observed in voltage mode circuits. A detailed analysis of these issues is the topic of ongoing research.

5. Linear applications of the MCDTA

The applications presented in the previous section assume that the MCDTA works as a high gain COA. In the ideal case transfer functions are independent of active element parameters and can be set by external passive components.

In some applications, especially in FPAA, the parameters are required to be electrically controlled. The subsequent paragraphs present a few of such linear applications built on the MCDTA circuit.

5.1. First order linear circuits.

Table 3 presents some of the first order linear circuits for filtering applications.

Each circuit presented in Table 3 (except for circuits number 4 and 5) contains only one grounded capacitor and its transfer characteristics can be controlled electrically. The high-pass filter (2) and all-pass filter (6) require a multiple output MCDTA circuit. This fact must be considered during the design process of the FPAA cell.

All-pass filters (circuits 4 and 5) based on the solution presented by Keskin and Biölek in [9] require a floating capacitor and a floating resistor, which can cause technological problems. Their transfer functions given in Table 3 are valid only in the ideal case - for input resistances of the p and n terminals equal to zero. In the real case the finite input resistances have to be treated as connected in series with the external components R and C . As a result, they influence the transfer function. The characteristic frequency of these two all-pass filters cannot be electrically controlled. The proposed circuit number 6 does not have these disadvantages.

Table 3
CDTA based first-order circuits

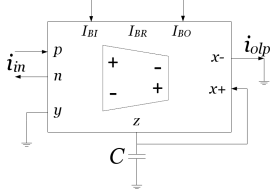
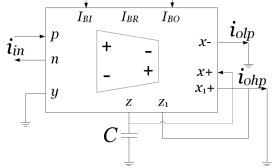
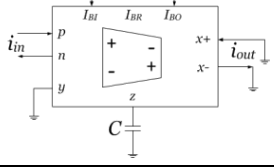
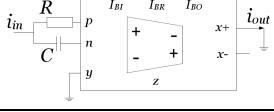
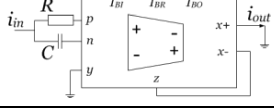
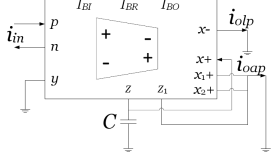
Circuit	Transfer function
<p>1. Current controlled low-pass filter</p> 	$\frac{i_{olp}}{i_{in}} = \frac{-1}{1 + s \cdot C/gm}$
<p>2. Current controlled low&high-pass filter</p> 	$\frac{i_{olp}}{i_{in}} = \frac{-1}{1 + s \cdot C/gm}$ $\frac{i_{ohp}}{i_{in}} = \frac{-s \cdot C/gm}{1 + s \cdot C/gm}$
<p>3. Current controlled current integrator</p> 	$\frac{i_{out}}{i_{in}} = \frac{-gm}{s \cdot C}$
<p>4. Current mode all-pass filter with gain [9]</p> 	$\frac{i_{out}}{i_{in}} = gmRz \frac{1 - sRC}{1 + sRC}$
<p>5. Current mode all-pass filter [9]</p> 	$\frac{i_{out}}{i_{in}} = \frac{1 - sRC}{1 + sRC}$
<p>6. Current controlled all-pass filter</p> 	$\frac{i_{oap}}{i_{in}} = \frac{-1 - sC/gm}{1 + sC/gm}$

5.2. Second order linear circuits. The MCDTA circuit with two additional capacitors can work as an universal biquadratic filter. The schematic is presented in Fig. 18.

The transmittance for the low-pass output is given by:

$$\frac{i_{Lp}}{i_{in}} = \frac{-1}{s^2 C_1 C_2 \frac{R_n}{g_m} + s C_2 \frac{R_n}{R_z g_m} + 1} \quad (18)$$

while the transmittance for the band-pass output is as follows:

$$\frac{i_{BP}}{i_{in}} = \frac{s C_2 R_n}{s^2 C_1 C_2 \frac{R_n}{g_m} + s C_2 \frac{R_n}{R_z g_m} + 1} \quad (19)$$

and the transmittance for the high-pass output is:

$$\frac{i_{HP}}{i_{in}} = \frac{-s^2 C_1 C_2 \frac{R_n}{g_m}}{s^2 C_1 C_2 \frac{R_n}{g_m} + s C_2 \frac{R_n}{R_z g_m} + 1} \quad (20)$$

One can see that the characteristic frequency f_0 of the circuit depends on the capacitances values and the ratio between R_n and g_m :

$$f_0 = \frac{1}{2\pi} \sqrt{\frac{g_m}{C_1 C_2 R_n}} \quad (21)$$

This ratio can be controlled by I_{BI} and I_{BO} currents values. According to relation (5) the n terminal input resistance is inversely proportional to the square root of the I_{BI} bias current. Similarly, the transconductance of the circuit third stage is proportional to the square root of control current I_{BO} (6). Finally, the characteristic frequency equals:

$$f_0 = \frac{1}{2\pi \sqrt{C_1 C_2}} \cdot \sqrt[4]{8\beta_D \cdot I_{BI} I_{BO}} \quad (22)$$

The quality factor depends on the R_z parameter. It can be controlled by the I_{BR} current. The tuning of this current does not influence the characteristic frequency.

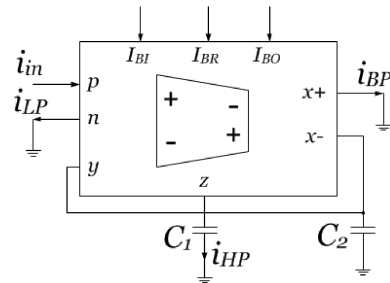

Fig. 18. MCDTA based universal biquadratic filter

Another example of a second order linear circuit is a quadrature sine-wave oscillator. It is possible to build a current mode oscillator in numerous ways. Some of them are presented in [6, 8, 9]. Another solution that requires only a single MCDTA circuit and two grounded capacitors is shown in Fig. 19.

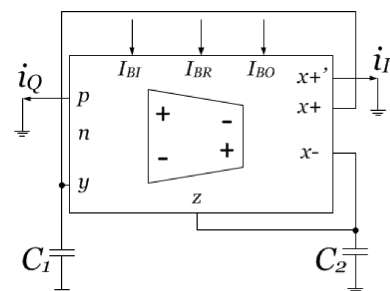

Fig. 19. MCDTA based quadrature oscillator

A detailed analysis of the circuit is presented in Sec. 7.

6. Non-linear applications of the MCDTA

The collection of the linear circuits presented above can be supplemented by several non-linear circuits. Each of the circuits presented below requires only two additional diodes and a single grounded capacitor.

6.1. Full wave and half-wave rectifiers with optional low pass filter. The full-wave and half-wave rectifiers are presented in Fig. 20a and 20b.

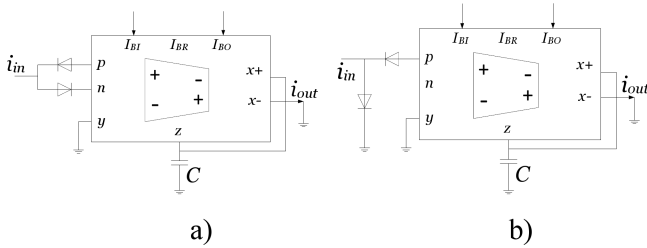

Fig. 20. MCDTA based rectifiers – a) full-wave, b) half-wave

The principle of operation of the full wave rectifier is as follows. The input current flows through one of two diodes depending on its sign. The z terminal current is equal to the absolute value of the input current and inverted:

$$i_z = -|i_{in}|. \quad (23)$$

This current is supplied to the RC circuit consisting of the capacitor C , and the current controlled resistor realized by the OTA circuit (output stage) with a negative feedback.

The output current equals:

$$i_{out}(s) = \frac{-1}{1 + s \cdot C/g_m} \cdot i_z(s). \quad (24)$$

The output current is equal to the filtered absolute value of the input current. The time constant of the filter can be tuned by the I_{BO} control current.

If we need the inverting rectifier, it is enough to reverse the direction of diodes.

If we need a rectifier without filtering, the capacitor has to be omitted. In this case the output current at every moment equals the absolute value of the input current.

The half-wave rectifier (Fig. 20b) works in a similar way. For the positive half-wave the input current is grounded and the i_z current equals zero. For the negative half-wave the input current is supplied to the p terminal and the further signal path is the same as in a full-wave rectifier.

6.2. Peak detector. The peak detector circuit based on MCDTA is shown in Fig. 21.

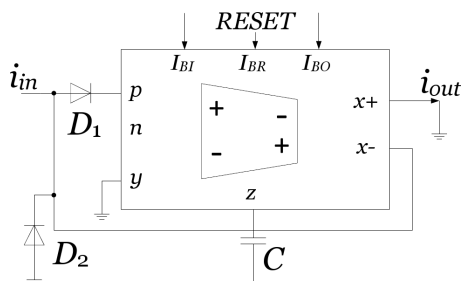

Fig. 21. MCDTA based peak detector

For the input current higher than the actual output current value the diode D_1 is open and the difference between the input and output currents charges the hold capacitor C until the

currents are equal. When the input current drops below the output current value, the diode D_2 is open and D_1 is closed. The z terminal current drops to zero and the capacitor holds the last voltage value. The capacitor C can be discharged by switching the R_{BR} current on. Thus the R_z resistor acts as a switch and assures the circuit reset function capability.

6.3. Track and hold circuit. The track and hold circuit based on MCDTA is shown in Fig. 22.

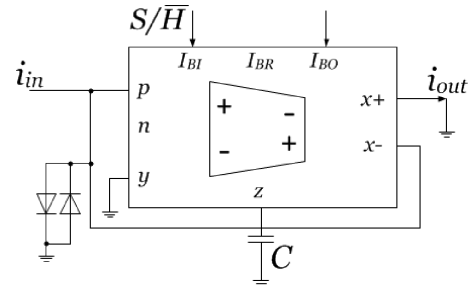

Fig. 22. MCDTA based track and hold circuit

The circuit is controlled by the I_{BI} current. In the tracking phase (I_{BI} switched on) the circuit works as a current follower (presented as example circuit nr 1 in Table 2). The tracking error depends on the capacitor C and the I_{BI} current values. A small tracking error can be obtained when the capacitor value is low and the I_{BI} current is high. The circuit is switched to the hold mode when the I_{BI} current is set to zero. When in the hold mode, the capacitor voltage is constant because the input stage is in the high impedance state and the output current is equal to the last value registered in the tracking phase. The diodes are included to ensure the current path for the input and output currents in the hold mode, when the p terminal is in the high- Z state. The hold error depends on the capacitor value, as well as on the leakage currents of the input stage in the high- Z state. A small hold error can be obtained when the capacitance value is large. As we can see, the requirements for the small track error and small hold error are contradictory. For proper selection of the hold capacitor C value we need a compromise between the requested sampling frequency and the input signal slew rate. The simulation results confirm that the described circuit can work properly in both sample and hold modes of operation.

7. Example of the MCDTA application – tunable quadrature sine-wave oscillator

In the literature concerning CDTA there can be found many implementations of the sine-wave oscillators [6, 8, 9]. However, none of the authors explains how to obtain the amplitude stabilization, which is the key problem in the sine-wave oscillators. The authors discuss only the oscillation conditions.

This research work includes the complete project of the tunable sine-wave oscillator with the amplitude regulation circuit. It contains two MCDTA circuits working as active elements. The first of them works in the oscillating structure

and the second one – in the nonlinear amplitude regulation circuit.

The schematic of the circuit is presented in Fig. 23.

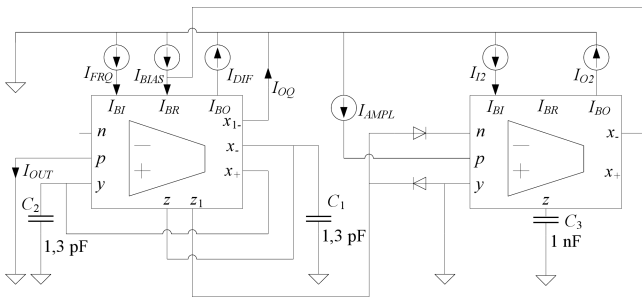

Fig. 23. MCDTA based tunable quadrature oscillator with amplitude regulation circuit

The first MCDTA circuit together with C_1 and C_2 capacitors form the oscillating structure. The characteristic equation of the circuit is given by (25):

$$s^2 C_1 C_2 \frac{R_p}{g_m} + s C_2 \frac{R_p}{g_m} \left(\frac{1}{R_z} - g_m \right) + 1 = 0. \quad (25)$$

It gives the oscillation frequency (26):

$$f = \frac{1}{2\pi} \sqrt{\frac{g_m}{C_1 C_2 R_p}} \quad (26)$$

and the oscillation condition (27):

$$g_m = 1/R_z, \quad (27)$$

where R_z – is the z terminal resistance dependent on I_{BR} current.

The formulae (25–27) confirm that the circuit is the sine-wave oscillator tunable with no interaction effect. The frequency can be tuned by means of R_p changes (value of I_{BI} current), and the amplitude can be adjusted by R_z changes (value of I_{BR} current). The transconductance g_m and also I_{BO} current should remain constant.

According to relation (5) the p terminal input resistance is inversely proportional to the square root of the I_{BI} bias current. Thus the oscillation frequency is given by (28):

$$f = \frac{1}{2\pi} \sqrt{\frac{g_m}{C_1 C_2}} \cdot \sqrt[4]{8\beta \cdot I_{FRQ}}. \quad (28)$$

Therefore, the oscillation frequency is proportional to the fourth root of the control current I_{FRQ} . It leads to the conclusion that the tuning span is relatively narrow. If we want to obtain the frequency span of one decade, we need to change the I_{FRQ} current by four decades, which can be difficult to achieve.

Similar implementation in bipolar technology requires only two decades of the control current change [14].

7.1. Amplitude control circuit. Amplitude regulation function is performed in the second MCDTA. The current differencing stage compares the half-wave rectified output current of the oscillator and the reference current I_{AMPL} . The difference of these currents charges the filtering capacitor C_3 .

The value of C_3 capacitor is relatively high (1 nF) and might be difficult to integrate. In the final realization this component should be connected externally as a discrete capacitor. (The usage of external components in the configurable analog modules is a common practice in the FPAAs applications.) The voltage across this capacitor controls the OTA and produces the control current that is supplied to the I_{BR} input of the first MCDTA to satisfy the oscillation condition. An additional current I_{BIAS} is delivered to the I_{BR} terminal to set the initial value of R_z resistance. In the steady state the mean value of the half-wave rectified oscillator output current should be equal to the reference signal value I_{AMPL} .

7.2. Simulation results. The circuit presented in Fig. 23, was simulated in LT SPICE IV environment. The simulation results confirm that the circuit produces the quadrature sine-wave oscillations and can be tuned electrically. Figure 24 shows two output currents of the circuit.

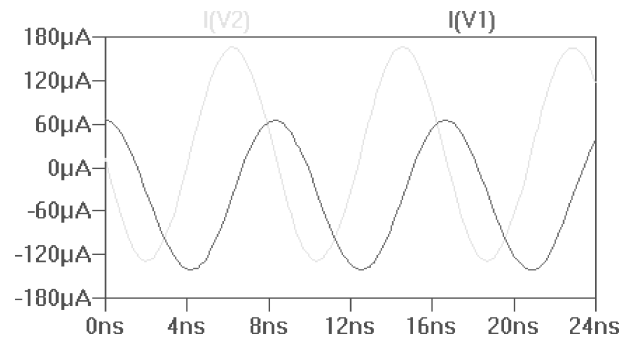

Fig. 24. Output currents of the quadrature oscillator

The control current changing in the range of 100 μA to 500 μA allows tuning the frequency from 93 MHz to 120 MHz with the THD level not worse than –36 dB. The application of this circuit as the heterodyne oscillator in a FM radio receiver is worth considering. The circuit can be fully integrated (except C_3) and does not require any external inductive components.

Figure 25 presents an example of a step response waveform for the amplitude control circuit (the C_3 capacitor voltage value). The steady state in the control loop was established in less than 5 μs in the whole range of the oscillation frequency.

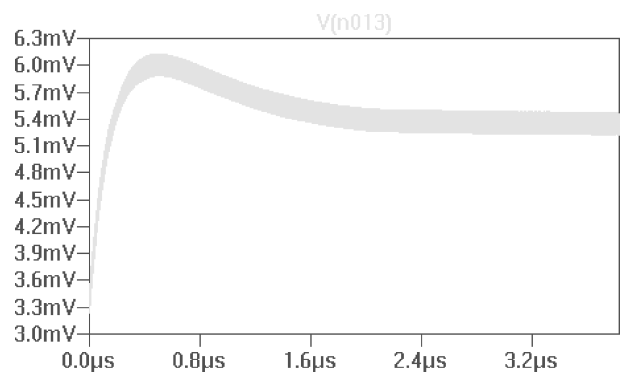

Fig. 25. Step response of the amplitude control loop

The current consumption of the oscillating circuit varied between 9 mA and 13 mA depending on the control current I_{FRQ} . The relatively high supply current value is the result of the construction of the MCDTA circuit. Each stage consists of a chain of branches biased by current mirrors. As we can see in Fig. 3, the current differencing stage consists of 7 branches, therefore the supply current of this stage is approximately 7 times higher than I_{BI} bias current. Similarly, the second stage contains 3 branches, which gives supply current value 3 times higher than the I_{BR} bias current. The transconductance stage supply current value is also approximately 3 times higher than I_{BO} bias current.

The high value of the supply current and power consumption is the cost of the flexibility of the MCDTA circuit. The wide span of parameter changes requires a wide control current range, which is the reason for high current consumption. Decreasing the current consumption is the topic of the future research work.

8. Conclusions

The Modified Current Differencing Transconductance Amplifier is a new versatile active component working in current

mode. Its basic parameters like input resistances, z terminal resistance and transconductance can be controlled by the electrical signals. It can work also as a fully differential current mode operational amplifier – in this mode the I_{BR} has to be switched off.

The catalog of the possible applications of this cell is very rich and is comparable to the catalog of the configurable analog modules possible to implement in commercially available FPAA circuits from Anadigm [3] or Cypress [4].

At the actual stage of this research work we can point out some disadvantages of the circuit. There can be observed a comparatively poor DC performance, which is caused by mismatching the NMOS and PMOS transistors static characteristics. Another problem is the narrow span of the parameter changes – the conductances and transconductances of the MOS circuits are proportional to the square root of the control current, whereas in the comparable bipolar circuits they are directly proportional to the control current value [14]. Solving these problems is the topic of future research work.

Nevertheless, the MCDTA circuit, thanks to its versatility, can be used in many analog applications both as a separate component and as a basic building block of the future current mode continuous time field programmable analog array.

Appendix A. MOS models [13]

```
.MODEL CMOSN NMOS (
+VERSION = 3.1          TNOM      = 27          LEVEL   = 8
+XJ      = 1.5E-7       NCH      = 1.7E17       TOX     = 1.42E-8
+K1      = 0.895708     K2      = -0.0999227    VTH0    = 0.6168698
+K3B     = -10.05102    W0      = 1E-8         K3      = 25.4743904
+DVT0W   = 0           DVT1W   = 0           NLX     = 1E-9
+DVT0    = 0.7713375   DVT1    = 0.3114417   DVT2W   = 0
+U0      = 452.6781994  UA      = 2.4385E-13   DVT2    = -0.499468
+UC      = 1.969478E-14 VSAT    = 1.99738E5    UB      = 1.420543E-18
+AGS     = 0.1040739   B0      = 1.726454E-6  A0      = 0.6298713
+KETA    = -8.051012E-3 A1      = 1.353122E-4  B1      = 5E-6
+RDSW    = 928.806964  PRWG    = 0.1358605   A2      = 0.3
+WR      = 1           WINT    = 2.48313E-7  PRWB    = 0.0119174
+XL      = 1E-7        XW      = 0           LINT    = 8.109645E-8
+DWB     = 2.29677E-8  VOFF    = -6.339922E-5 DWG     = -1.339219E-8
+CIT     = 0           CDSC    = 2.4E-4       NFACTOR = 0.8346881
+CDSCB   = 0           ETA0    = 1.799253E-3   CDSCD   = 0
+DSUB    = 4.427664E-3 PCLM    = 2.1419353   ETAB    = 0.937327
+PDIBLC2 = 1.956003E-4 PDIBLCB = 0.4672463    PDIBLC1 = 4.529032E-5
+PSCBE1  = 1.91176E9   PSCBE2  = 7.618757E-4 DROUT   = 9.193807E-4
+DELTA   = 0.01       RSH     = 87.6         PVAG    = 0
+PRT     = 0           UTE     = -1.5        MOBMOD  = 1
+KT1L    = 0           KT2     = 0.022       KT1     = -0.11
+UB1     = -7.61E-18  UC1     = -5.6E-11    UA1     = 4.31E-9
+WL      = 0           WLN     = 1           AT      = 3.3E4
+WWN     = 1           WWL     = 0           WW      = 0
+LLN     = 1           LW      = 0           LL      = 0
+LWL     = 0           CAPMOD  = 2           LWN     = 1
+CGDO    = 1.85E-10   CGSO    = 1.85E-10    XPART   = 0.5
+CJ      = 4.206687E-4 PB       = 0.8444434   CGBO    = 1E-9
+CJSW    = 3.457742E-10 PBSW    = 0.8           MJ      = 0.4298533
+CJSWG   = 1.64E-10  PBSWG   = 0.8         MJSW    = 0.2061949
+CF      = 0           PVTH0   = -0.0322165  MJSWG   = 0.2061949
+PK2     = -0.0565947 WKETA   = 0.0118474    PRDSW   = 299.2575266
*)
*
```

```

.MODEL CMOSF PMOS (
+VERSION = 3.1          TNOM    = 27          LEVEL  = 8
+XJ      = 1.5E-7       NCH    = 1.7E17       TOX    = 1.42E-8
+K1      = 0.553472     K2     = 7.871921E-3  VTH0   = -0.9152268
+K3B     = -0.0293138  W0     = 1E-8         K3     = 7.109257
+DVT0W   = 0           DVT1W  = 0           NLX    = 5.256387E-8
+DVT0    = 0.6948189   DVT1    = 0.3116809  DVT2W  = 0
+U0      = 201.3603195 UA     = 2.408572E-9  DVT2   = -0.3
+UC      = -1E-10      VSAT    = 9.561814E4  UB     = 1E-21
+AGS     = 0.1093988   B0     = 4.801437E-7  A0     = 0.8483918
+KETA    = -4.865785E-3 A1     = 5.962367E-5  B1     = 4.099582E-9
+RDSW    = 3E3         PRWG    = -0.0281924  A2     = 0.5590966
+WR      = 1           WINT    = 2.409366E-7  PRWB   = -0.0478369
+XL      = 1E-7        XW     = 0           LINT   = 1.227569E-7
+DWB     = -1.300242E-8 VOFF    = -0.0569316  DWG    = 2.997976E-9
+CIT     = 0           CDSC    = 2.4E-4       NFACTOR = 1.0767165
+CDSCB   = 0          ETA0    = 6.272245E-4  CDSCD  = 0
+DSUB    = 0.7238536  PCLM    = 2.5009221  ETAB   = -0.0691875
+PDIBLC2 = 3.486214E-3 PDIBLCB = -0.0101883  PDIBLC1 = 0.0690875
+PSCBE1  = 1E8        PSCBE2  = 3.35E-9    DROUT  = 0.2788577
+DELTA   = 0.01       RSH     = 106.1      PVAG   = 7.241842E-3
+PRT     = 0          UTE     = -1.5       MOBMOD = 1
+KT1L    = 0          KT2     = 0.022      KT1    = -0.11
+UB1     = -7.61E-18  UC1     = -5.6E-11   UA1    = 4.31E-9
+WL      = 0          WLN     = 1          AT     = 3.3E4
+WWN     = 1          WWL     = 0          WW     = 0
+LLN     = 1          LW      = 0          LL     = 0
+LWL     = 0          CAPMOD  = 2          LWN    = 1
+CGDO    = 2.28E-10  CGSO    = 2.28E-10  XPART  = 0.5
+CJ      = 7.129098E-4 PB       = 0.8659226  CGBO   = 1E-9
+CJSW    = 2.398618E-10 PBSW    = 0.8          MJ     = 0.4866798
+CJSWG   = 6.4E-11   PBSWG   = 0.8        MJSW   = 0.2181641
+CF      = 0          PVTH0   = 5.98016E-3  MJSWG  = 0.2181641
+PK2     = 3.73981E-3 WKETA   = 6.53022E-3  PRDSW  = 14.8598424
*                                     LKETA  = -5.667325E-3 )

```

REFERENCES

- [1] I. Mucha, "Towards a true current operational amplifier", *IEEE Int. Symp. on Circuits and Systems* 5, 389–392 (1994).
- [2] R. Wojtyna and T. Talaska: "Transresistance CMOS neuron for adaptive neural networks implemented in hardware", *Bull. Pol. Ac.: Tech.* 54 (4), 443–448 (2006).
- [3] The Anadigm Web Page, <http://anadigm.com> (2012).
- [4] The Cypress Web Page <http://www.cypress.com/psoc> (2012).
- [5] F. Kacar and H. Kuntman, "A new CMOS current differencing transconductance amplifier (CDTA) and its biquad filter application", *IEEE Eurocon* 1, 189–196 (2009).
- [6] W. Jaikla and M. Siriruchyanan, "A versatile quadrature oscillator and universal biquad filter using dual-output current controlled current differencing transconductance amplifier", *Int. Symp. on Communications and Information Technologies, ISCIT 2*, 1072–1075 (2006).
- [7] C. Tanaphatsiri, W. Jaikla, and M. Siriruchyanun, "An electronically controllable voltage-mode first-order all-pass filter using only single CCCDTA", *Int. Symp. on Communications and Information Technologies, ISCIT 1*, 305–309 (2008).
- [8] A. Lahiri, A. Misra, and K. Gupta, "Novel current-mode quadrature oscillators with explicit-current-outputs using CC-CDTA", *19th Int. Conf. Radioelektronika* 1, 47–50 (2009).
- [9] A.U. Keskin and D. Biolk, "Current mode quadrature oscillator using current differencing transconductance amplifiers (CDTA)", *Circuits, Devices and Systems, IEE Proc.* 1, 214–218 (2006).
- [10] R. Sotner, J. Petrzela and J. Slezak, "Current mode tunable KHN filter based on controlled MO-CFTAS", *3rd Int. Conf. on Signals, Circuits and Systems (SCS)* 1, 1–4 (2009).
- [11] M. Siriruchyanun and W. Jaikla, "Realization of current controlled current differencing transconductance amplifier (CC-CDTA) and its applications", *ECTI Trans. on Electrical Engineering, Electronics and Communications* 1, 41–50 (2007).
- [12] M. Siriruchyanun, P. Silapan, and W. Jaikla, "Low-offset BiCMOS current controlled current differencing buffered amplifier (CC-CDBA) and applications", *ECTI Trans. on Electrical Eng., Electronics and Communications* 6 (1), 81–90 (2008).
- [13] The MOSIS Service, <http://www.mosis.com> (2012).
- [14] A. Malcher and P. Falkowski, "A modified current-differencing transconductance amplifier and its applications", *XI IFAC/IEEE Int. Conf.: Programmable Devices and Embedded Systems* 1, 206–211 (2012).
- [15] A. Sedra and K. Smith, "A second-generation current conveyor and its applications", *IEEE Trans. on Circuit Theory* 17, 132–134 (1970).
- [16] T. Zagajewski, "General principles of similarity of electric networks", *Bull. Pol. Ac.: Tech.* 20, 417–428 (1972).
- [17] G.W. Roberts and A.S. Sedra: "A general class of current amplifier-based biquadratic filter circuits", *IEEE Trans. on Circuits & Systems* 39 (4), 257–263 (1992).