

## APPLICATION OF ANALYTIC DATABASES TO SUPPORT DECISION MAKING IN STRUCTURAL ENGINEERING

J. SZELKA<sup>1</sup>, Z. WRONA<sup>2</sup>

Complex structural engineering projects that involve information-gathering and decision-making processes need to be approached with appropriate systems and tools. As transactional databases are found to be insufficient for this purpose, engineers are adopting multidimensional information systems that have been successfully used in other areas of management, especially business.

*Key words:* Engineering decisions, information system, systems approach, computer-based decision support, transactional databases, analytic databases.

### 1. INTRODUCTION

The tasks of structural engineering requiring data analysis can be categorized in three areas: organization, decision making and execution. Attention should be paid to analytic tasks due to their complexity and importance. An engineering analysis requires a substantial amount of decision making, and its results affect the quality of other operations. For example, decisions concerning the selection of the most suitable structure type or construction method will have influence on such activities as organization and execution.

In an engineering analysis, the decision making process needs to be based on advanced data sets. The quality of the information resources is largely dependent on the completeness, certainty, and validity of data. It can be assumed that the methods of data representation – information structures – and the software tools used for data processing are also important.

Resources of information used for analyzing structural engineering problems are complex in nature, therefore their structures need to be represented by a systems approach.

In many areas of management, including structural engineering, data are organized by means of database structures based on models of systems theory. In majority of cases, however, these databases structures and the corresponding tools for data processing

---

<sup>1</sup> D.Sc. WSO WL i UZ, e-mail: jszelka@wso.wroc.pl

<sup>2</sup> Ph.D. Eng, Wyższa Szkoła Zarządzania Edukacja in Wrocław

are sufficient to deal with current operations only; they are efficient and effective for record and information purposes. Their usefulness for engineering analyses, especially those with complex, multidimensional or specific problems (e.g. emergency situations), may be considerably lower. The principle of handling the problem is presented in Fig. 1.

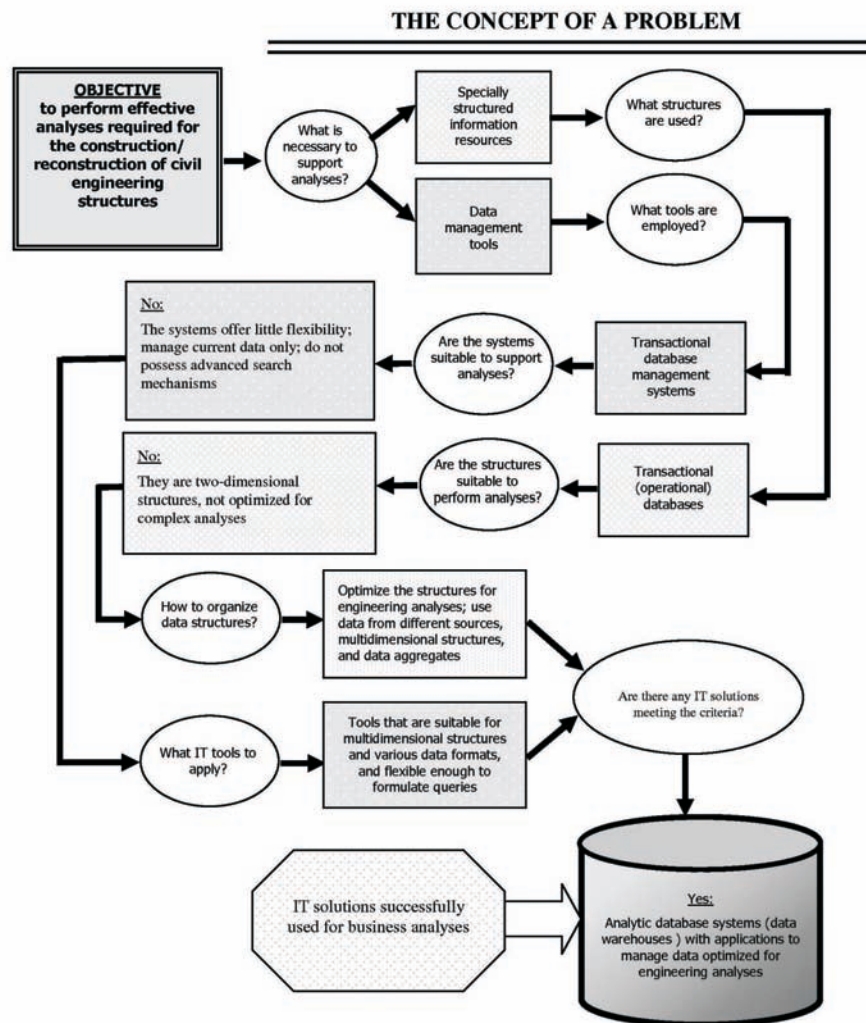

Fig. 1. Supporting an engineering problem.  
Rys. 1. Wspomaganie problemu inżynierskiego

## 2. THE ROLE OF INFORMATION MODELS IN DECISION-MAKING PROCESSES

All systems, including those created to deal with engineering problems, can be regarded as multichannel data converters with easy-to-distinguish infrastructures. The information about the limits and elements of a given system, the relationships between the elements and between the system and the environment can be treated as a subsystem [Sienkiewicz, 17]. It is essential to point out that if engineers analyze an object from the physical world, they describe it as an abstract structure. The connections between the different areas established to find out about the real system are referred to as an information system [Cieciura, 4].

Information systems enable gathering, processing, storing and distributing information. From the engineering point of view, the most useful are systems of decision support (systems) and special-purpose systems, as recommended by the literature [Bień, 3]. Decision support systems are applied to meet the needs encountered during decision-making processes. Special-purpose information systems, on the other hand, are employed to meet the information needs and prepare data sets to support data handling processes, including those conducted for decision purposes.

As the quality of an analysis and, consequently, the quality of decisions made based on results of the analysis, are largely dependent on the quality of the information resources and their applicability to decision-making processes, an information system cannot be treated separately from a decision support system (Fig. 2).

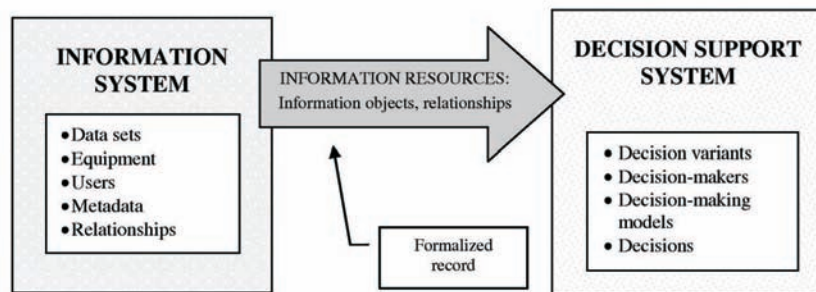

Fig. 2. Importance of data in information and decision support systems according to [Penc, 15].

Rys. 2. Znaczenie informacji w systemach informacyjno – decyzyjnych wg [Penc, 15]

In order to ensure that right decisions are taken, it seems vital to determine the range and organization of data, as well as the system processing capabilities.

In a structural engineering analysis, which involves the processes of information gathering and decision making, the number of elementary events and objects, as well as their mutual relationships to be taken into account, is assumed to be so large that it is necessary to apply a systems approach [Bień, 3]. This allows considering a complex fragment of reality as a whole. The complexity becomes even more visible

in emergency situations, when there may be a considerable increase in the number of limitations defining the sets of admissible solutions, e.g. poor availability of equipment or structure elements, deadlines, etc. .

After identifying the structure of an engineering system to be constructed, or otherwise dealt with, and determining the impact of the environment, it is possible to apply simplifications that will allow generating a model - an abstract recorded in a formalized form - without changing the system character. Modeling as a problem-solving method seems to be of particular significance to decision making also in the area of structural engineering.

Problems related to the construction/reconstruction of an engineering structure are solved by analyzing a variety of factors such as needs related to the use, and local availability of materials, manpower, and equipment. It is thus essential to consider not only the effects of each factor on the area of admissible solutions but also the relationships between these factors. Moreover, the analysis should be conducted taking into account the influence of the environment on the needs, resources, and conditions of all engineering activities, as illustrated in Fig. 3.

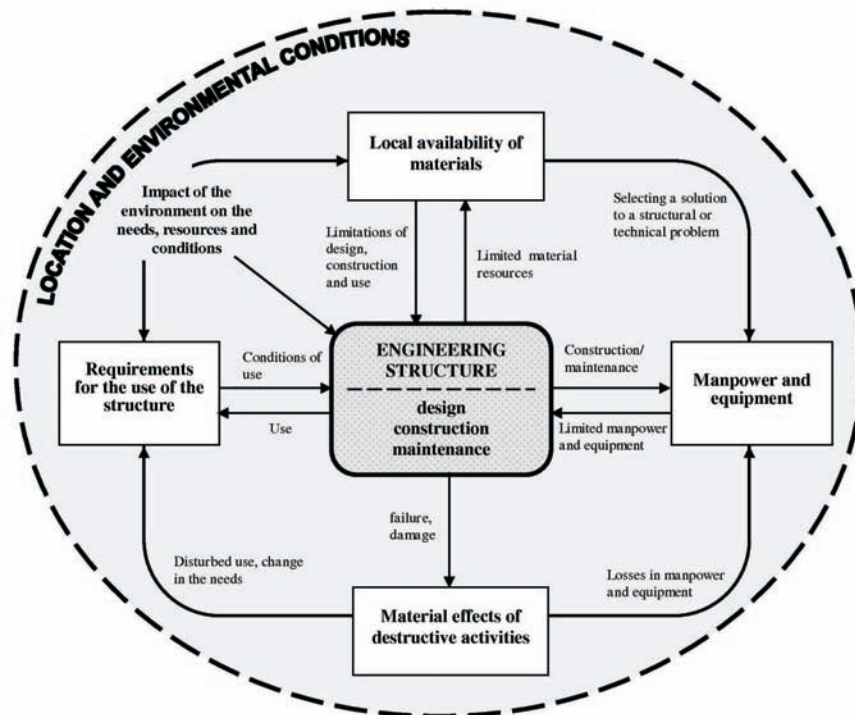

Fig. 3. Dealing with an engineering problem.

Rys. 3. Opis sytuacji problemowej w obszarze budownictwa lądowego

It is necessary for an engineer to take into account the complex information resources, where each of the system objects is characterized by a large number of attributes assuming different values, as well as networks of relationships between the system elements. These requirements make the analysis very difficult. It is significant that the limitations related to the access to numerous data describing the system should also be included. It is thus suggested that certain irrelevant or unknown aspects of the system described are omitted and that the system is represented as a model [Kapliński, Janusz, 9].

As a representation of a real system, e.g. a structure or organization, a model makes it possible to simplify the reality without losing information relevant from the point of view of the tasks to be performed [Kapliński, 5]. The form of the model, e.g. with mathematical or graphical notation, is dependent mainly on the model applications. The modeling effects can then be used for other groups of engineering tasks (Fig. 4).

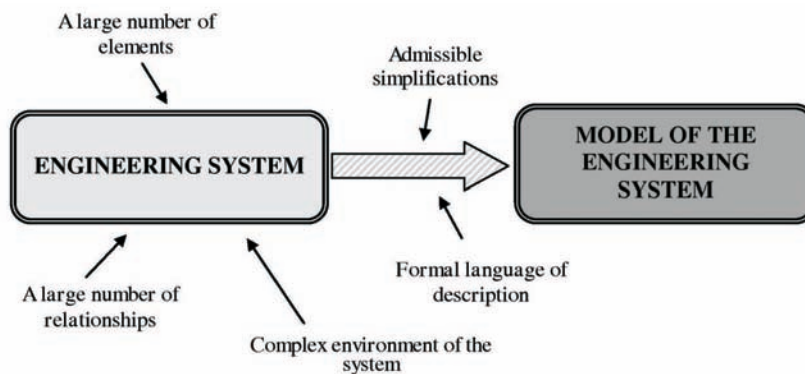

Fig. 4. A concept of modeling in structural engineering.

Rys. 4. Istota modelowania w obszarze budownictwa lądowego

Among the numerous models used in practice for describing a fragment of reality in the information context, the most significant are the Data Flow Diagram and the Entity Relationship Diagram [Barker, 1]. The Data Flow Diagram illustrates mutual relationships between information objects and processes performed within the system. In order to develop such a model, it is necessary to identify information objects and their attributes. Such identification is required also for creating the Entity Relationship Diagram being recognized as a basic abstract describing an information system. This latter model is considered to be a model of relationships between information objects or between entities. The system is thus represented as a set of mutually related information objects defined by their names and attributes. Considering a bridge construction project in the information context, one can distinguish such objects and attributes as: *waterway* (name, location, width, depth, ...), *bridge* (type, load capacity, length, average duration, ...), or *span* (type, length, load capacity, ...).

As it is important to assure the quality of decision-making processes, the models are applied to define the structures of information resources and data handling processes in the information systems supporting analytic operations (Fig. 5).

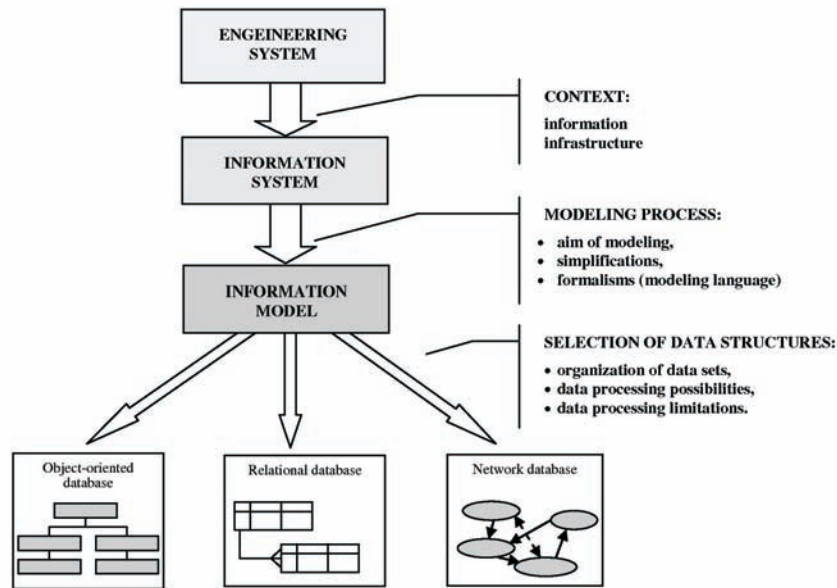

Fig. 5. Organization of different database structures as a result of information modeling, according to [Zaskórski, 21].

Rys. 5. Istota procesu organizacji różnych struktur danych w wyniku realizacji modelowania informacyjnego wg [Zaskórski, 21]

The way the information resources are organized may be important to assure the completeness of information about objects or engineering tasks; it is also responsible for information retrieval and processing required for an analysis.

### 3. APPLYING DATABASE SYSTEMS TO INFORMATION GATHERING AND DECISION MAKING PROCESSES

Because of considerable differences between types of decision problems or forms of input and output data, engineering processes can be supported using a wide range of tools from typical spreadsheets to specialized integrated information systems (CAD, CAE).

The applicability of a tool depends on its functionality, i.e. functions offered, as well as on its information range, which defines the resources to be stored, processed or distributed.

It can be assumed that, irrespective of the area of management considered, information resources in information-decision systems are generally gathered in database

structures [Beynon-Davies, 2]. Exceptions may be ill-structured or non-structured problems of decision, for which information resources are gathered in a knowledge base. In such cases, databases are used as supplementary structures [Szelka, Wrona, 20].

A database is a set of data recorded in a defined way into structures corresponding to the assumed data model. Figure 6 illustrates the organization of information resources in database structures for a complex, multi-aspect bridge reconstruction project.

The simplest method of data organization is by using a table model. It assumes storing information about objects in the  $\langle \text{object}_i, \text{attribute}_i, \text{value}_i \rangle$  system. An object is represented by a two-dimensional table with an assigned name (e.g. *bridge object*). Each of the columns in the table represents one object attribute (e.g. *load capacity*). The rows, on the other hand, contain values of the attributes of elements selected for the bridge description. Numerous examples of data structured in this way, used as parameter libraries, can also be found in the area of structural engineering, e.g. electronic databases for prices and standards.

Data can be organized using a simple table model or:

- a relational data model for representing the reality in the form of sets of tables linked by relationships;
- an object-oriented data model designed to classify objects, their properties, and specific principles of heredity of property [Beynon-Davies, 2].

In object-oriented databases, data are stored in object-oriented structures referred to as classes. Studies concerning the application of object-oriented databases were conducted most intensively in the 90s; now it is known that their contribution to data gathering or processing is negligible.

It is estimated that more than 90% of all database systems used nowadays are based on the **relational model** [Cieciura, 4].

The concept of a relational model can be reduced to several elementary assumptions:

All data are stored in two-dimensional tables; each table is assigned to a different information object (bridge, span, bridge construction).

The objects in the tables are identified by a primary key attribute, e.g. table: *bridge*; primary key attribute: *bridge Id*.

All the tables are linked by relationships of various types so that no table is isolated, e.g. the *bridge* table is linked with the *span* table. The relationships between tables reflect the relationships between objects; thus, data in one table are always considered in a wider context.

Figure 7 exemplifies the organization of a section of a database storing information about bridge construction projects.

Based on mutual relationships between tables, it is possible to link a construction project to a waterway described by a set of values of (the) particular attributes, as well as a bridge type. Each bridge type is then linked to the basic parameters and also to the information about the bridge construction elements such as spans, piers, etc.

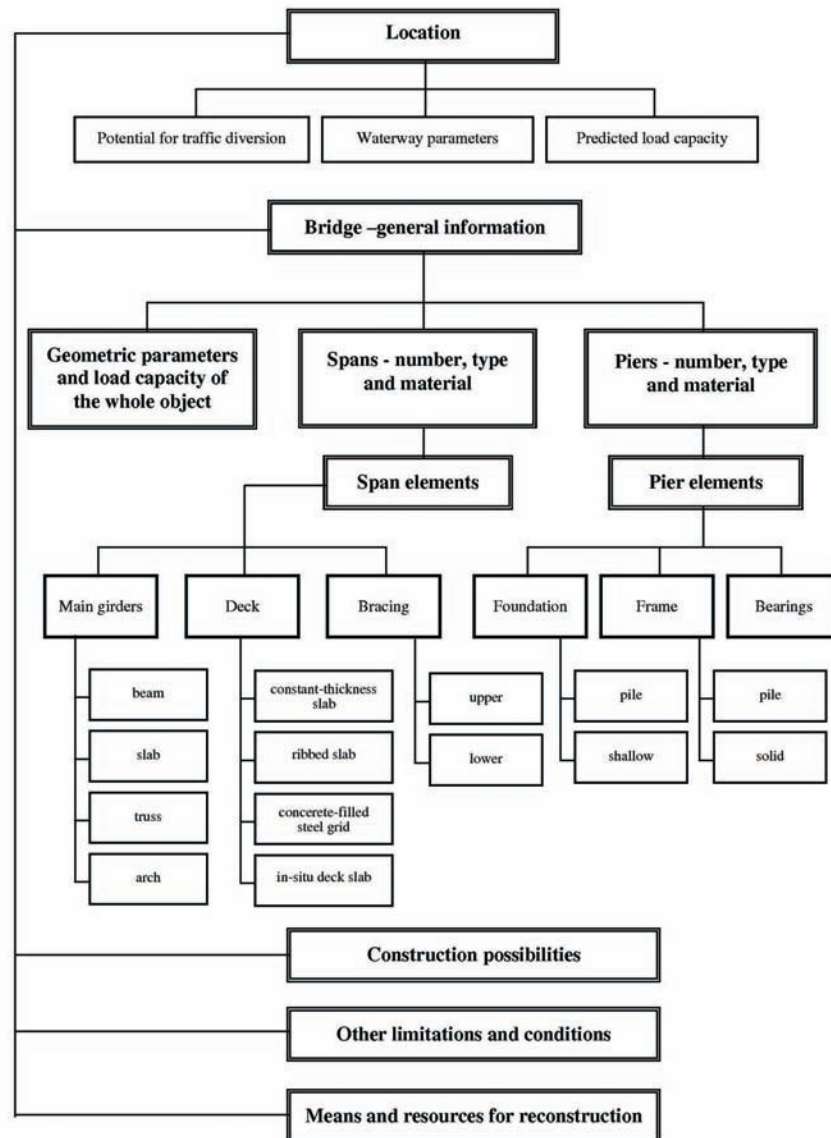

Fig. 6. Structure of a bridge reconstruction database.  
Rys. 6. Struktura bazy danych do odbudowy obiektu mostowego



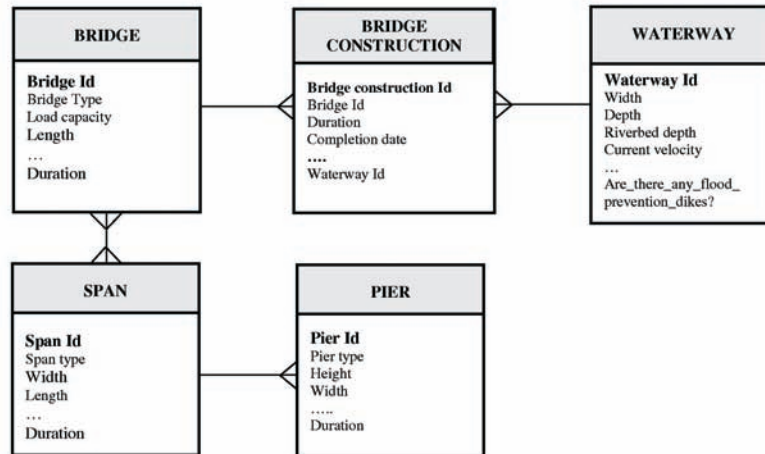

Fig. 7. A section of a relational structure including data about the bridge construction.

Rys. 7. Fragment struktury relacyjnej obejmującej informacje o montażu obiektów mostowych

Relational structures can be used to memorize not only the alpha-numeric values but also graphic, audio or video materials.

As it is necessary to simultaneously store and process considerable amounts of data, relational databases are optimized so that redundant data are minimized and anomalies connected with data updating are eliminated. The above requirements imply using advanced data structures, because eliminating redundancies is equivalent to increasing the number of tables and abandoning the storage of attributes whose values can be determined based on other attributes - the so-called calculable attributes. In order to manage a transactional database, it is necessary to apply an algorithmic tool known as a *Database Management System* (DBMS).

Figure 8 illustrates a DBMS with structured data resources constituting a *Database System* (DBS).

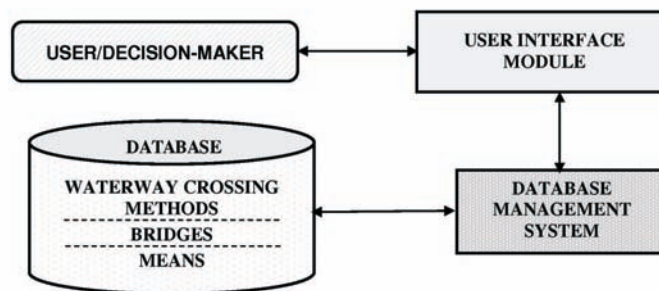

Fig. 8. Simplified structure of a database system.

Rys. 8. Uproszczona struktura systemu bazy danych

The data available within the system are gathered in an operational (transactional) structure of the database. This means that the database is updated by an operator while the system operates. Any data aggregates – total, averaged, and other summaries – are always designed for a short time span; they are generally related to a period being recorded.

Examples of systems using transactional databases include libraries of specifications and performance details for bridges, spans, etc., or catalogues with bridge construction equipment. Transactional databases are also used to develop integrated systems with different degrees of integration and extended functional ranges.

Figure 9 illustrates a functional structure of database system with considerably extended functions. The order of the functions to be performed is determined by the functional model, so the output data of one function constitute the data necessary to initiate the subsequent function. Even in such a case, the information that is relevant for these activities comes from a uniform, transactional database, for which the above limitations concerning the structures and the data management application are valid.

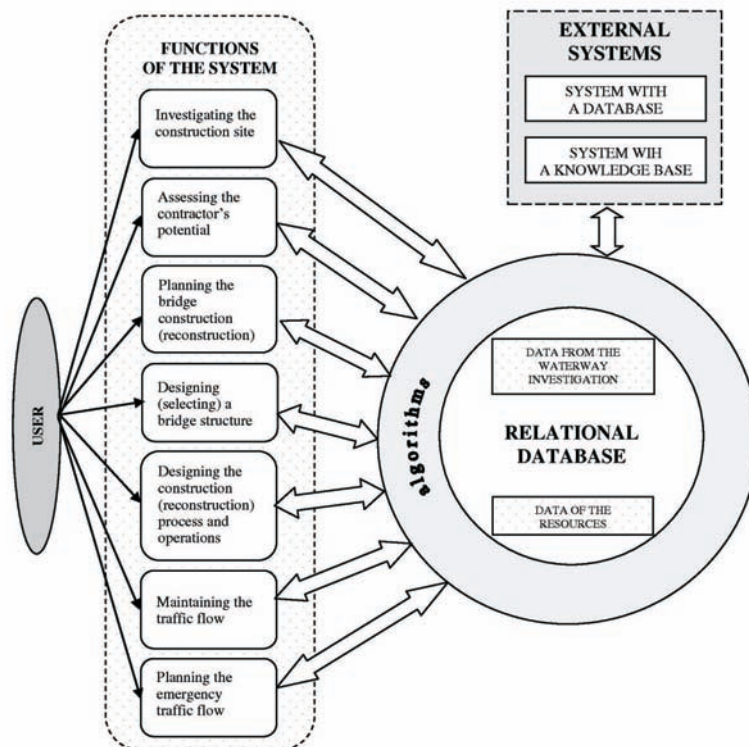

Fig. 9. Functional scheme of a transactional database system with a potential to use external systems.

Rys. 9. Schemat funkcjonalny systemu transakcyjnej bazy danych z możliwością wykorzystania systemów zewnętrznych

The cooperation with external systems – other databases or knowledge bases – needs to be defined precisely at the design stage for both the functional and information areas.

#### 4. SUPPORTING ANALYTIC INFORMATION AND DECISION TASKS

Tasks that are analytic in nature are frequently dealt with using different criteria, e.g. time and location, which are considered in connection with the basic data. Multi-criteria analyses require operational (current) and historical data, as well as information about related events, are readily available. Thus, they can be used, for instance, to analyze the market behavior or to predict phenomena on the basis of data aggregates gathered over a long period of time.

In the field of structural engineering, a large number of projects are analytic in character. Examples include developing and analyzing alternative solutions suitable for a given transport infrastructure, e.g. a bridge. Engineers need access to many different sources of data in order to perform successful calculation analyses, evaluate standard structural solutions, consider emergency situations with probable scenarios of bridge failure, or even destruction, due to warfare or terrorist attacks (Fig. 10), and analyze the economic and organizational aspects of the project.



Fig. 10. Bridge failure and its reconstruction using fold-up segments.

Rys. 10. Zniszczenie obiektu mostowego i jego odbudowa za pomocą konstrukcji składanych

IT support for this type of analyses is possible only if there is an access to many different sources of transactional data, data aggregates, and external sources with a non-standardized structure [Kisielnicki, 12].

As it is essential to analyze many different “dimensions” of the criteria data (e.g. time, location, technology), one can no longer apply two-dimensional structures that are suitable for transactional databases. The effect of “multidimensionality” of data

structures is achieved by applying advanced data representation models, e.g. *data cube*, *star* or *snowflake schemas*.

The multidimensional structure of a database bases on:

- facts;
- dimensions.

Facts represent elementary data cells and are described by different attributes, the so-called measures, which are frequently numeric in nature. An order can be an example of a fact where an amount and value of an ordered product is a measure.

Dimensions, on the other hand, are quantities that may form hierarchies. Typical dimensions are, for instance, time, location and client. Facts linked by relationships with dimensions constitute the central element of a multidimensional structure.

Figure 11 illustrates the application of the star schema to data management based on four dimensions. The first scheme refers to order placing, and the four dimensions are: item, location, time, and promotion. The same structure can be used to manage a structural engineering project, i.e. bridge construction, with four dimensions being a bridge type, location, time, and method of construction.

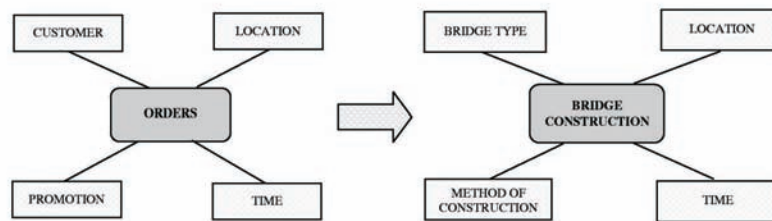

Fig. 11. A multidimensional model (star schema) used for the subject area of orders and its equivalent for bridge engineering.

Rys. 11. Wielowymiarowy model dla obszaru tematycznego zamówień – schemat gwiazdy i jego odpowiednik dla obszaru budownictwa mostowego

Applying multidimensional structures to the management of data from areas other than business seems to be not only possible but also advisable. These models are suitable to deal with analytic problems encountered in structural engineering. Multidimensional structures can store, for instance, information on bridge construction projects including temporary bridges – Fig. 12.

The table of facts may include the required attributes of construction, while the dimension tables allow time variants of the attribute values or space variants of the construction. Each of the dimension tables corresponds to a different location (region).

Figure 13 shows a cube structure referring to the construction of temporary folding bridges.

A data model becomes multi-dimensional when a basic, two-dimensional structure, called a fact table is supplemented with further dimensions (tables), referred to as criteria dimensions (e.g. time, region – location).

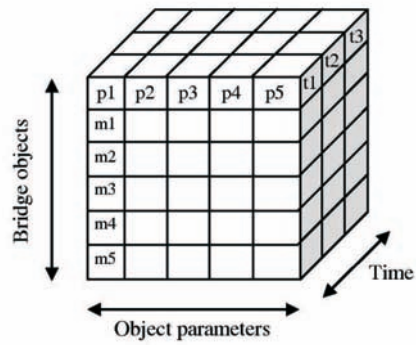

Fig. 12. A multidimensional data structure applied to an engineering problem.  
Rys. 12. Wykorzystanie wielowymiarowej struktury danych w obszarze budownictwa

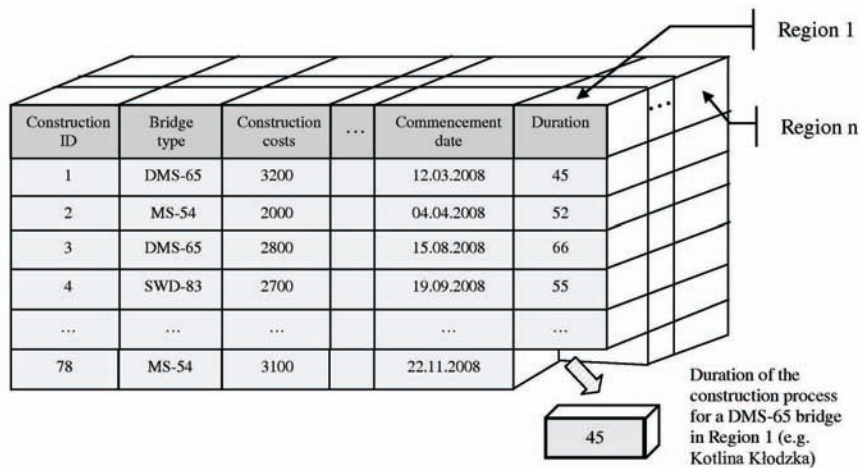

Fig. 13. A multidimensional structure used for storing information on temporary bridge construction projects.  
Rys. 13. Wykorzystanie struktury wielowymiarowej do przechowywania informacji o przedsięwzięciach montażu mostów tymczasowych

Figure 13 illustrates a two-dimensional fact table storing information about a project of folding-bridge construction for one location (region). Introducing an additional dimension (region), one is able to overview all projects of temporary bridge construction at different locations (regions).

This model of data organization is suitable for various operations related to data manipulation. The key operations performed using a multidimensional model are: slicing, filtering, narrowing, aggregation and roll-up.

Data slicing is performed in order to create a subset of data by determining the terms concerning the dimension values. An example of data selection for the term: *Region = 2* (e.g. *Kotlina Kłodzka*), is shown in Fig. 14.

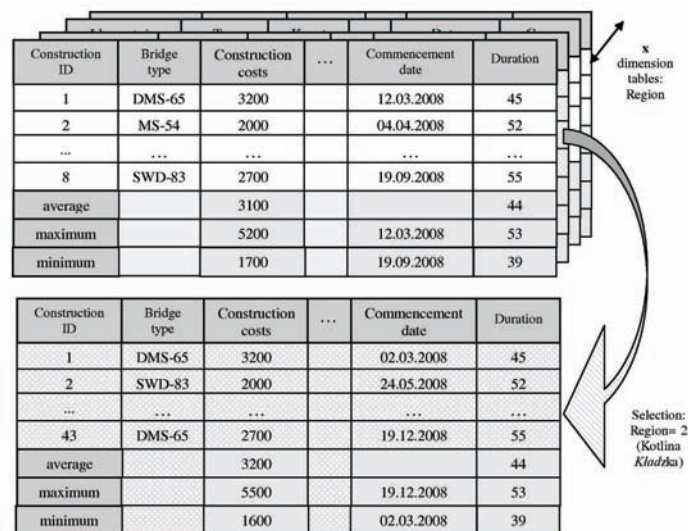

Fig. 14. Data selection process in a multidimensional database structure.  
Rys. 14. Proces selekcji danych w strukturze wielowymiarowej bazy danych

The process of data filtering or screening involves generating a subset of data on the basis of the limitations assumed for the values of the attributes in the fact table or the dimension tables. The derived data can be limited, for instance, to the DMS-65 type bridge and the segmental construction method.

Aggregation, also called a roll-up operation, allows moving to a more general dimension level for a given aggregating measure (sum, average, percentage). For instance, one can determine the average, minimum and maximum, values of the "construction time" parameter for a given region, and also define the above aggregating measures for the aggregated time measure, determined by the construction time (month, quarter, season), as illustrated in Fig. 15.

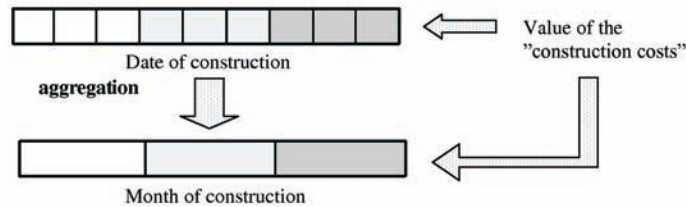

Fig. 15. Data aggregation in a multidimensional database.

Rys. 15. Proces agregacji danych w strukturze wielowymiarowej bazy danych

This, in turn, allows analyzing bridge construction projects undertaken in a given region at a given time of the year.

The source data, data aggregates, and external data, e.g. expertise, required for an analysis are searched for using a special data mining module. A simplified process of data mining and solving of analytic problem (solving) based on analytic database structures is shown in Fig. 16 [Szelka, Wrona, 19].

where:

$a_1...a_s$  – detailed attributes

$A_1, A_2, A_z$  – data aggregates

$w_{xy}$  – values of detailed attributes ( $x$  – number of the attribute in the fact table,  $y$  – number of the dimension table)

$W_{Ax}$  – aggregated values

$K_W$  – set of the output information required for the process of deduction

Since it is possible to use a number of different operational data sources and acquire data from external systems such as parameter libraries, price lists, and GIS systems, it is vital that efficient tools be applied to data management. In order to use multidimensional structures and non-uniform data sets for analytic purposes, one needs advanced algorithmic tools capable, for instance, of separating necessary data, eliminating redundant ones, and integrating different data into a common format. The system has to be equipped with a mechanism which not only selects from a closed list of options but also defines advanced queries directed to the database.

Systems performing the above tasks and using analytic databases as information resources are defined as **data warehouses**. A data warehouse is equivalent to the database system (DBS) described in Sec. 3. The difference lies in the organization and optimization of data necessary to conduct the most complete analysis for a selected fragment of reality [Kolbusz, Rejer, 13].

Figure 17 shows the principle of data warehouse organization.

A data warehouse consists of sets of subject-oriented data. An example is a warehouse for bridge construction projects. Data come from different sources, and they are read-only, which assures their historicity. Warehouses, however, are periodically updated. Information resources of a data warehouse generally include operational (current)

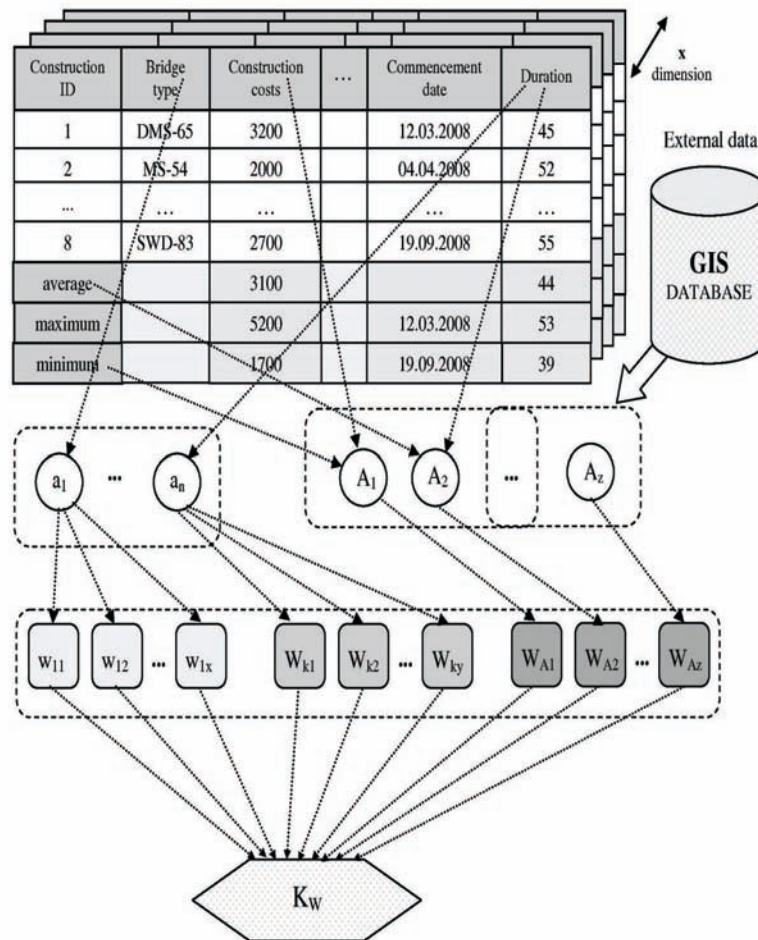

Fig. 16. Developing solutions to an analytic problem using an analytic database.

Rys. 16. Proces wypracowywania rozwiązania problemu analitycznego z użyciem analitycznej bazy danych



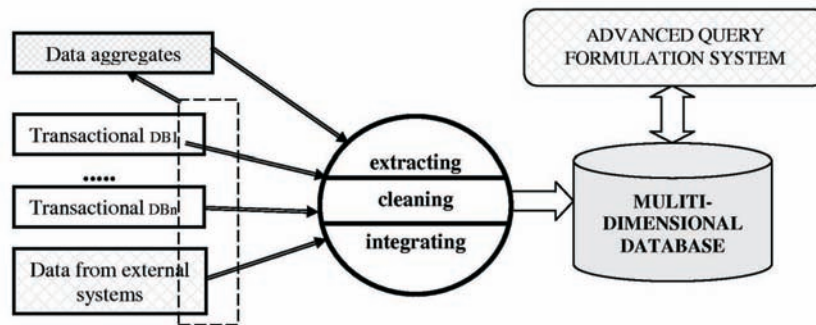

Fig. 17. Data warehouse organization according to [Zaskórski, 21].

Rys. 17. Organizacja hurtowni danych [wg Zaskórski, 21]

and historical data as well as different data aggregates, which convert sets of detailed values into single values, e.g. a sum, an arithmetic mean, or a minimum.

## 5. CONCLUSION

The effects of a computer-aided analysis used to support a structural engineering task are dependent on a number of factors. Complex engineering problems require applying appropriate methods and tools for data organization and management. Transactional database systems, which are commonly used for information gathering and decision making, have been found insufficient for analytic purposes. The main problem lies in the inefficiency of the data storing, handling and management processes. Transactional database structures are not suitable for analyses because of the two-dimensionality of table structures. Data structures need to be optimized so that they are well-suited for operational processing and minimizing redundant information. This means that values which are calculable or aggregated in nature are eliminated from information resources, although they are important in analytic tasks.

The corresponding software tools intended for the algorithmic processing of data gathered in transactional databases are also regarded as unsuitable for dealing with problems which are analytic in character. The range of viable activities performed by these applications, including aggregate or query formation, needs to be defined at the stage of system design. The limitations of these systems are related to the data processing capabilities. The systems will process certain types of data organized into strictly defined structures.

The only IT solutions appropriate for analytic applications are data warehouses using multidimensional structures in the processes of data gathering, handling and distribution.

The systems were primarily used to support business (financial) analyses but they seem perfectly suited to deal with engineering problems as well. Applying data warehouses to engineering appears to be substantially and economically justified, even though developing analytic applications is a complex, time-consuming and costly process. The systems are assumed to meet high serviceability requirements; they are capable not only of gathering historical data but also supporting various current analytic-type problems.

## REFERENCES

1. R. BARKER, Case Method. *Modelowanie związków encji*, [in Polish] WNT, Warszawa 2005.
2. P. BEYNON-DAVIES, *Systemy baz danych*, [In Polish], WN-T, Warszawa 2002.
3. J. BIEŃ, *Modelowanie obiektów mostowych w procesie ich eksploatacji*, [in Polish], Oficyna Wydawnicza Politechniki Wrocławskiej, Wrocław 2002.
4. M. CIECIURA, *Podstawy technologii informacyjnych z przykładami zastosowań*, [in Polish], VIZJA PRESS&IT, Warszawa 2006.
5. O. KAPLIŃSKI, Problems of the information technologies use [in Polish] construction sector: state of the art, *Archives of Civil Engineering*, 2009.
6. O. KAPLIŃSKI, L. JANUSZ: Multifactor Modelling in Construction Management, *1<sup>st</sup> International Conference on Construction Engineering and Management*, Seoul 2005, pp. 633-637.
7. O. KAPLIŃSKI, E. ZAVADSKAS, *Expert systems for construction processes*. *Statyba* (Journal of Civil Engineering and Management), pp. 12, 4, 49-61, 1997.
8. O. KAPLIŃSKI, IT Applications in Polish Construction Sector. *The 25<sup>th</sup> International Symposium on Automation and Robotics in Construction, ISARC-2008*, Vilnius, June 26-29, pp. 483-489, 2008.
9. O. KAPLIŃSKI, L. JANUSZ: *Three phases of multifactor modelling of construction processes*. *Journal of Civil Engineering and Management*, **12**, 2, June 2006, pp. 127-134.
10. O. KAPLIŃSKI, L. JANUSZ: A new approach to design and modeling of flexible corrugated steel plate structures under construction. [w] *Innovations in Structural Engineering and Construction*. Y.M. Xie & I.Patnaikuni (Eds.). Taylor & Francis Group, London 2007, ISBN 978-0-415-45755-2, pp. 219-224.
11. T. KASPROWICZ, *Inżynieria przedsięwzięć budowlanych* [in Polish], ITE, Radom 2003.
12. J. KISIELNICKI, H. SROKA, *Systemy informacyjne biznesu* [in Polish], Placet, Warszawa 2005.
13. E. KOLBUSZ, I. REJER, *Wstęp do informatyki w zarządzaniu* [in Polish], Wydawnictwo Uniwersytetu Szczecińskiego, Szczecin 2007.
14. R. MARCINKOWSKI, *Metody rozdziału zasobów realizatora w działalności inżynieryjno-budowlanej* [in Polish], wyd. WAT, Warszawa 2002.
15. J. PENC, *Decyzje menadżerskie – o sztuce zarządzania* [in Polish], Wydawnictwo C.H.Beck, Warszawa 2007.
16. W. RADOMSKI, W. TROCHYMIAK, Zastosowanie komputerów w mostownictwie. *Metody komputerowe w Inżynierii Lądowej* [in Polish], Vol. 2, No 1-2/92.
17. P. SIENKIEWICZ, *Analiza systemowa. Podstawy i zastosowania* [in Polish], Bellona, Warszawa 1994.
18. J. SZELKA, Z. WRONA, *Informatyczne wspomaganie działań organizacyjnych i wykonawczych przy budowie obiektów inżynieryjnych* [in Polish], Pięćdziesiąta Pierwsza Konferencja Naukowa „Krynica 2005”, **4**, pp. 201-208.
19. Wykorzystanie analitycznych baz danych w procesach budowy (odbudowy) obiektów inżynieryjnych [in Polish], Pięćdziesiąta Czwarta Konferencja Naukowa „Krynica 2008”, **5**, pp. 647-556.

20. J. SZELKA, Z. WRONA, Wspomaganie działań inżynierskich za pomocą systemów ekspertowych, w: Kapliński O. (red), [in Polish], *Metody i modele badań w inżynierii przedsięwzięć budowlanych*, PAN KILiW – IPPT, Warszawa 2007.
21. P. ZASKÓRSKI, *Strategie informacyjne w zarządzaniu organizacjami gospodarczymi* [in Polish], WAT, Warszawa 2005.

### ABSTRACT

Decision making problems encountered in structural engineering are generally multi-stage operations of a considerable degree of complexity. It is essential that such analyses are conducted by advanced information resources and complex relationships between data objects. Advanced information resources require, however, advanced information operations including data gathering, storing, processing and distribution. In order to handle the information complexity, it is vital to apply a systems approach. This approach can be used to describe structures and functions of engineering systems, as well as develop information and functional models of database systems with the aim of performing the most appropriate information-decision processes. It is also important that suitable software tools are applied.

One of the most common information solutions used in various areas of management, including structural engineering, is a database system enabling efficient organization and processing of data.

Information resources are stored in a database using two-dimensional tables linked by relationships. Data structures are optimized for processing current (transactional) data. Data handling is performed by using algorithmic applications referred to as database management systems.

Database systems are applied to support a majority of information and information-decision tasks. Their suitability to support decision making processes, particularly analyses, is considered to be limited, which is mainly due to little information and functional flexibility. The insufficient flexibility of information systems may cause various data formats, especially those from external systems, and "rigid" data structures, which need to be defined as early as at the system design stage, not accepted. Similar limitations are reported for a functional system, the use of which is strictly defined, e.g. data search or aggregation.

It has been necessary to develop a new concept of a database system so that the expectations of various areas of data management, whether related to business or engineering, can be met. Databases are now optimized with a view to perform complex analyses, and not only support current, transactional operations. Multidimensional database structures and the corresponding tools for data processing make it possible to use different data sources, and create advanced aggregates and queries, whose forms do not need to be defined at the system design stage. It can be assumed that since analytic processes required for structural engineering projects are similar in structure to those performed in the area of business, the solutions concerning analytic databases can be the same. The multidimensionality of data structures, applicability of external sources, such as GISs or historical data, may contribute to a considerable increase in the efficiency and effectiveness of analytic processes in the area of structural engineering.

### ZASTOSOWANIE ANALITYCZNYCH BAZ DANYCH PRZY PODEJMOWANIU DECYZJI W OBSZARZE BUDOWNICTWA LĄDOWEGO

#### Streszczenie

Zagadnienia decyzyjne z obszaru budownictwa lądowego należą do przedsięwzięć wieloetapowych, o znacznym stopniu skomplikowania. Złożoność ta wynika z konieczności uwzględniania w procesach analizy

rozbudowanych zasobów informacyjnych oraz skomplikowanych relacji między obiektami informacyjnymi. Poziom skomplikowania zasobów informacyjnych niesie za sobą złożoność procesów informacyjnych, obejmujących: gromadzenie, przechowywanie, przetwarzanie i dystrybucję informacji. Warunkiem uporania się ze złożonością informacyjną jest wykorzystanie do opisu budowy lub funkcjonowania systemów inżynierskich podejścia systemowego. Tworzone w oparciu o to podejście modele informacyjne i funkcjonalne systemu pozwalają na dobór najbardziej odpowiednich do realizacji procesów informacyjno-decyzyjnych, struktur danych. Dodatkowym wymogiem sprawnej realizacji tych procesów jest zastosowanie odpowiednich narzędzi ich komputerowego wspomaganie.

Śród dostępnych rozwiązań informatycznych, umożliwiających zarówno organizowanie informacji, jak i ich przetwarzanie, przy wykorzystaniu podejścia systemowego, do najczęściej wykorzystywanych w różnych obszarach zarządzania, także w budownictwie lądowym, należą systemy baz danych. Zasoby informacyjne przechowywane są w bazie danych w oparciu o dwuwymiarowe tabele powiązane relacjami. Struktury danych są optymalizowane pod kątem bieżącego (transakcyjnego) przetwarzania informacji. Przetwarzanie danych realizowane jest przez algorytmiczne aplikacje, określane mianem systemów zarządzania bazą danych.

Systemy baz danych wykorzystuje się powszechnie do wspomaganie zdecydowanej większości przedsięwzięć informacyjnych oraz informacyjno-decyzyjnych o charakterze operacyjnym. Ich przydatność do wspomaganie procesów decyzyjnych, a zwłaszcza analiz należy jednak uznać za ograniczoną, głównie ze względu na małą elastyczność informacyjną i funkcjonalną tego typu systemów. W obszarze informacyjnym, mała elastyczność przejawia się trudnościami w akceptowaniu różnorodnych formatów danych (zwłaszcza z systemów zewnętrznych) oraz "sztywnymi" strukturami danych, które muszą być definiowane już w procesie projektowania systemu. Podobne ograniczenia można wskazać w odniesieniu do zakresu funkcjonalnego systemu, który jest ściśle określony, np. w zakresie wyszukiwania, czy agregacji danych.

Podobne problemy, występujące także w innych obszarach zarządzania, a zwłaszcza w przypadku analiz biznesowych, stały się bodźcem do podjęcia działań zmierzających do opracowania nowej koncepcji systemów baz danych. Zasadnicza różnica polega na optymalizowaniu bazy danych nie pod kątem działań bieżących (transakcyjnych), ale pod kątem analiz. Zaproponowano wielowymiarowe struktury baz danych oraz sprawne narzędzia ich przetwarzania, umożliwiające wykorzystywanie różnorodnych źródeł danych, tworzenie złożonych agregatów oraz złożonych zapytań, których postaci nie muszą być zdefiniowane w fazie projektu systemu. Wydaje się, że uwzględniając podobieństwo struktury procesów analitycznych, występujących w obszarze budownictwa lądowego (czy szerzej – w obszarze inżynierii lądowej) do tych, które występują w innych obszarach zarządzania ( np. w obszarze działań biznesowych), można dokonać próby zaadoptowania rozwiązań w zakresie analitycznych baz danych do wspomaganie rozwiązania przedsięwzięć analitycznych w obszarze inżynierii. Wielowymiarowość struktur danych, możliwość wykorzystywania źródeł zewnętrznych, takich jak bazy danych GIS czy danych historycznych mogą w znaczny sposób zwiększyć skuteczność a także efektywność procesów analitycznych w obszarze budownictwa lądowego.

*Remarks on the paper should be  
sent to the Editorial Office  
no later than September 30, 2010*

*Received November 15, 2009  
revised version  
June 15, 2010*