

Noise properties of thin-film Ni-P resistors embedded in printed circuit boards

A.W. STADLER^{1*}, Z. ZAWIŚLAK¹, W. STĘPLEWSKI², and A. DZIEDZIC³

¹ Department of Electronics Fundamentals, Rzeszow University of Technology, 12 Powstańców Warszawy St., 35-959 Rzeszów, Poland

² Tele and Radio Research Institute, 11 Ratuszowa St., 03-450, Warszawa, Poland

³ Faculty of Microsystem Electronics and Photonics, Wrocław University of Technology, 11/17 Janiszewskiego St., 50-370 Wrocław, Poland

Abstract. Noise studies of planar thin-film Ni-P resistors made in/on Printed Circuit Boards, both covered with two different types of cladding or uncladded have been described. The resistors have been made of the resistive-conductive-material (Omega-Ply[®]) of 100 Ω /sq. Noise of the selected pairs of samples has been measured in the DC resistance bridge with a transformer as the first stage in a signal path. $1/f$ noise caused by resistance fluctuations has been found to be the main noise component. Parameters describing noise properties of the resistors have been calculated and then compared with the parameters of other previously studied thin- and thick-film resistive materials.

Key words: thin-film resistors, Ni-P foil, $1/f$ noise, low-frequency noise measurements.

1. Introduction

Present-day electronics demands small-size and reliable components and modules. A technique of embedding passives into Printed Circuit Boards (PCBs) is one of the methods used for miniaturization of electronic components and modules. It is getting important because the placing of large number of components inside a substrate brings to advantages like a reduction in a surface of an overall circuit and an improvement of its electrical properties, for example a shortening of conducting paths, what results in a diminishing parasitic capacitances and inductances. Another advantage of this technique is a decreasing in the number of necessary external electronic components and solder joints. Taking into account another trend observed in modern electronics, namely restrictions concerning a power consumption, which makes both the supply voltages and the useful signal amplitude smaller, one may notice that the intrinsic noise of the electronic components is getting one of the most important performance parameters. Thin-film resistors made of a nickel-phosphorus (Ni-P) alloy foil are a good example of modern embedded passives [1]. They are used for very demanding specialized electronics like military and high frequency applications as well as in dynamic memory modules that take advantages of the embedded passives technique. However, so far there are not too much thorough studies of electrical properties of the passives embedded in the PCBs [2–4]. To fill the gap, the authors present in this work the results of their studies on noise properties of planar Ni-P resistors prepared on the PCBs, both uncladded and with cladding made of different materials. Moreover, it should be noted that apart from research aspects stated above, there is a relationship between noise properties of an electronic component and its reliability.

2. Samples preparation

The sample resistors were prepared as squares of 0.5 mm size using the two-stage etching of the laminated Cu and the Ni-P layers deposited on the FR4 (OmegaPly[®]) substrate. The thickness of the resistive Ni-P foil was 0.1 μ m, and its nominal sheet resistance was 100 Ω /sq. Sets of 10 resistors were created on each substrate during one process. The embedding of the components was made by coating them with the layers of either RCC (*Resin Coated Copper* – copper foil with the epoxy resin layer of 25–35 μ m thickness; laminated with the surface while the resin is the binder; copper foil was etched after lamination process) or LDP 2×106 (*Laser Drillable Pre-Preg* – the layer of the epoxy resin reinforced with the fiberglass mesh; 2×106 denotes that double layer of 106 material was used; regular mesh of 106 material enhances its mechanical durability).

3. Measurement setup

The most important difficulties during noise measurements were caused both by the dissipated surface power density limit of 50 mW/mm² determined previously from thermographic images [4] and the relatively small resistance of the samples which was about 100 Ω . These circumstances implied the use of a low-noise transformer as the first stage in a signal path what resulted in the use of Wheatstone bridge configuration in order to eliminate DC offset. Noise spectra were measured in the circuit sketched in Fig. 1. A pair of the samples (selected from the resistors prepared on one substrate with respect to matched resistance) was mounted in the bottom legs of the DC bridge while the upper legs of the bridge included the wirewound ballast 10 k Ω resistors fulfilling the condition of a quasi-current excitation of the studied resistors. In order to balance the bridge also wirewound adjustable resis-

*e-mail: astadler@prz.edu.pl

tor was inserted in one of the upper legs of the bridge. The bridge was supplied from the programmable voltage source (Keithley 2636) through low-pass filter of large time constant in order to reject interferences from power-line. The voltage signal from the bridge diagonal including voltage fluctuations risen in both samples was amplified firstly in the low-noise transformer (EG&G model 1900) and secondly in the low-noise amplifier (EG&G model 5184) of fixed 1000 gain and the AC coupling. The signal was then low-pass filtered and delivered to a personal computer equipped with a DAQ-board where an analog-to-digital conversion took place. Detailed considerations of the noise measurement technique with the use of a transformer were described in [5]. Using a specialized software, with an FFT algorithm implementation, power spectral density S_V of voltage fluctuations was calculated for time records of 2 s duration. The consecutive spectra were averaged in real-time by 440 minutes. The experiments were performed at room-temperature for 4 or 5 pairs of samples from each of substrate, some of them were repeated.

For each pair of the samples several quantities were measured at room temperature including (i) the resistance of the specimens in order to calculate the resistivity ρ of the Ni-P layer, (ii) noise spectra with no supply voltage, $S'_{V=0}$, which were used for calibration of the measurement setup (its gain and frequency response), (iii) spectra S'_V at dif-

ferent sample voltages in order to determine excess noise, $S_{Vex} = (S'_V - S'_{V=0})/K^2(f)$, where $K(f)$ is the transfer function of the measurement system. In order to calculate $K(f)$, thermal noise of the samples under test (with no bias) was used as a wide-band test signal of known, $4kTR_{AB}$, power spectral density, where k is Boltzmann constant, T – temperature, R_{AB} – equivalent resistance of the circuit connected to the input of the transformer. Resistance R_{AB} was measured at the balanced bridge. Resistances of samples A and B created the bottom legs of the bridge, decided about the R_{AB} value. Eventually, transfer function was calculated using the relation $K^2(f) = (S'_{V=0} - S_{amp})/4kTR_{AB}$, where S_{amp} is noise of the amplifier, which was measured in a separate experiment. Moreover, the quantity $S_{V=0} \equiv (S'_{V=0} - S_{amp})/K^2(f)$ was used for a verification in the following part of the work. It should be noted, that the transfer function of the transformer strongly depends on the resistance of the signal source and hence it must be determined for each pair of the studied samples separately, what additionally enhanced time of the experiment.

Average resistances of the samples for each substrate, gathered in Table 1, are only slightly larger than the nominal resistance of the Ni-P layer, what means that contact resistance is insignificant, assuming that the errors of sample geometry are neglected.

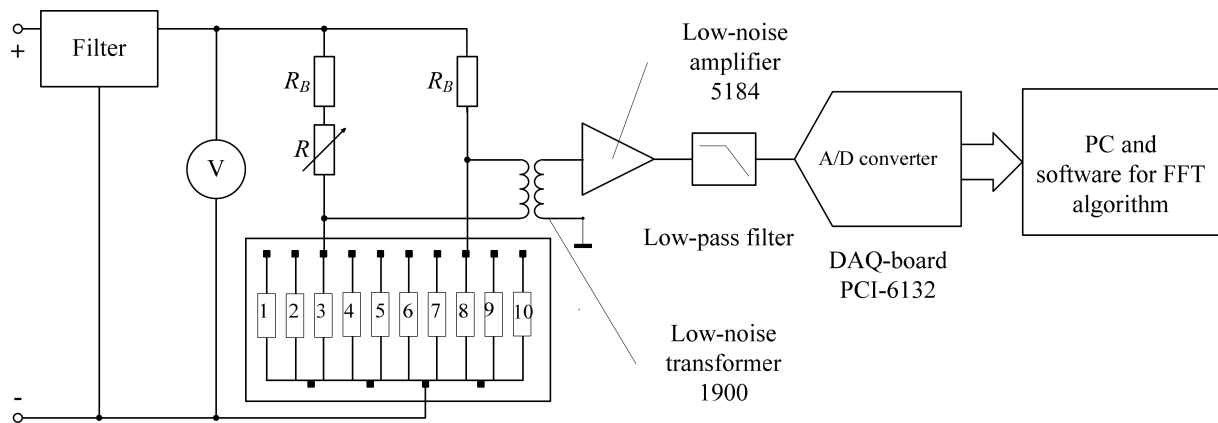

Fig. 1. The measurement setup for noise studies in the Ni-P thin-film resistors embedded in PCBs

Table 1
 Electrical and noise parameters obtained for the embedded Ni-P resistors

Parameter	cladding		
	no cladding	RCC	2×106
resistance, R [Ω]	109.41	115.48	117.3
resistivity, ρ [Ωcm]	0.0010941	0.0011548	0.001173
noise intensity, C [m^3]	$2.14 \cdot 10^{-30}$	$5.2 \cdot 10^{-30}$	$2.5 \cdot 10^{-31}$
current noise index CNI [dB]	-37	-33	-46
K [$\mu\text{m}^2/\Omega$]	$2 \cdot 10^{-13}$	$4.6 \cdot 10^{-13}$	$2 \cdot 10^{-14}$

4. Noise components identification

Noise spectra have been measured for different sample bias voltages in the frequency f range from 1 Hz to 1 kHz with 0.5 Hz resolution. The set of the exemplary spectra $S_{V_{ex}}$ has been plotted in Figs. 2 and 3. Spectra $S_{V=0}$ have been also added for reference. It is worth to note, that noise of such low intensity could be measured only due to the use of the transformer as the first stage in the signal path. For frequencies larger than 100 Hz significant spread of $S_{V_{ex}}$ spectra is visible due to the method of its calculation.

Looking at the excess noise spectra one may conclude that $1/f$ noise component is dominant in the studied samples.

Hence, the product $fS_{V_{ex}}$ averaged over frequency band Δf , $\langle fS_{V_{ex}} \rangle_{\Delta f}$, is the convenient measure of a noise intensity. The exemplary plots of the noise intensity calculated in this way have been shown in Fig. 4.

The plots in Figs. 4 and 5a exhibit quadratic dependence of the noise intensity, calculated in decade frequency bands, on sample voltage, what is the evidence that the observed noise is caused by resistance fluctuations. Small discrepancy of the noise intensity in the different frequency bands has been observed due to the value of the spectral exponent which was 1.2; 1.1; 1.14 for the samples for which the data have been presented in Figs. 4a, 4b and 5a, respectively.

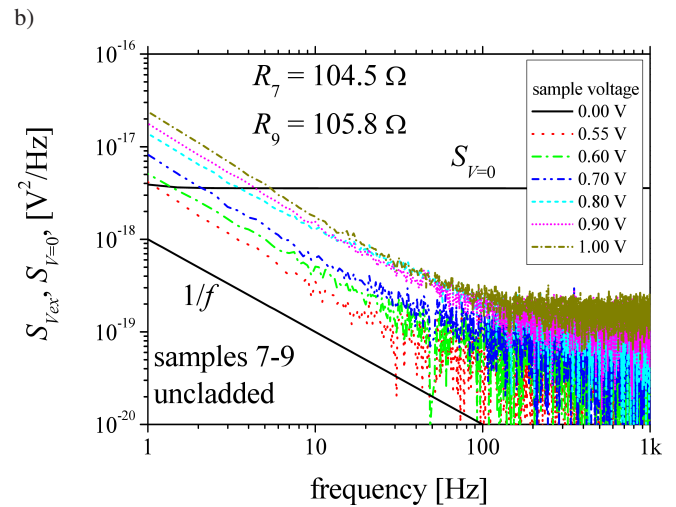
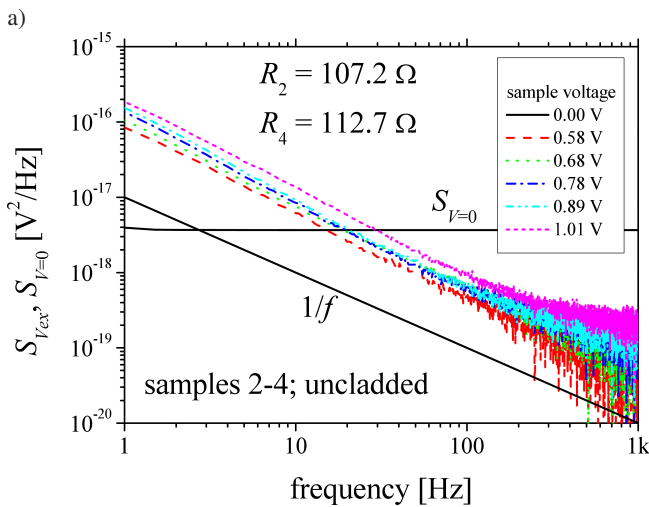

Fig. 2. Spectra $S_{V_{ex}}$ and $S_{V=0}$ for the Ni-P uncladded resistors. Sample voltages are listed in the legend. The solid line, added for reference, shows pure $1/f$ noise

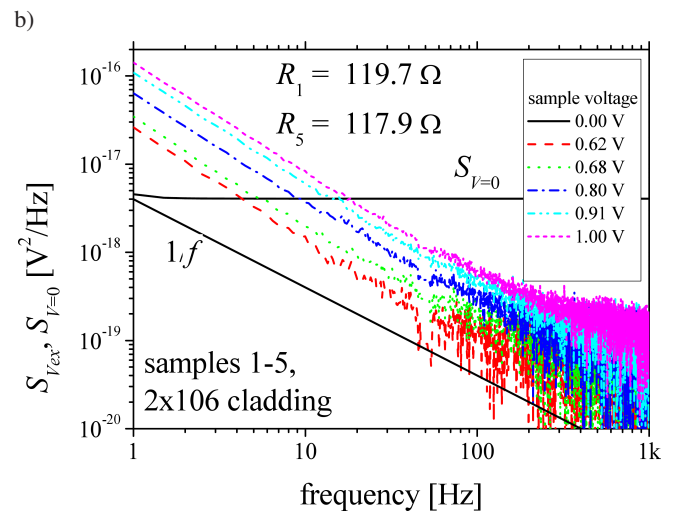
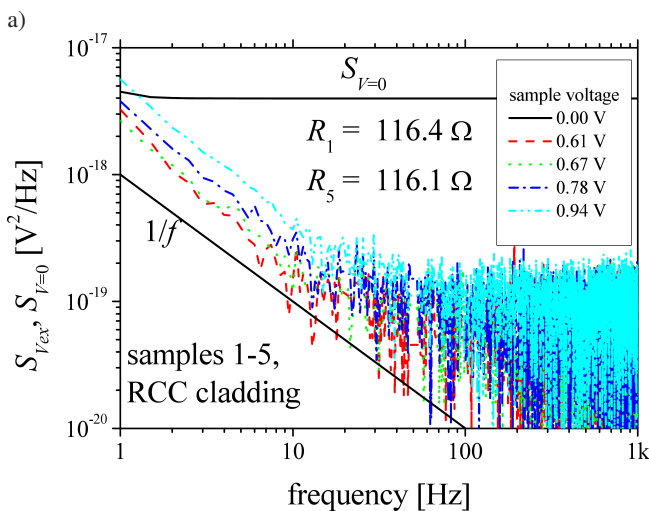

Fig. 3. Spectra $S_{V_{ex}}$ and $S_{V=0}$ for the Ni-P resistors with cladding. Sample voltages are listed in the legend. The solid line, added for reference, shows pure $1/f$ noise

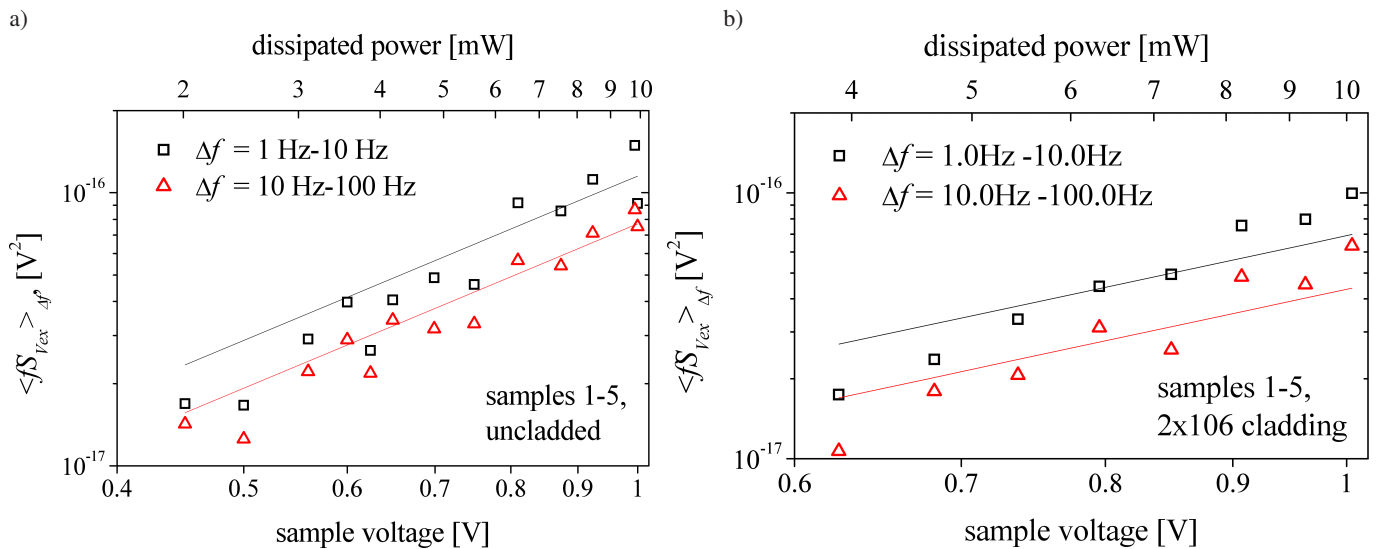

Fig. 4. The noise intensity vs. the sample voltage (points) with their quadratic approximations (lines) for the uncladded samples (figure a) and for the samples with 2×10^6 cladding (figure b)

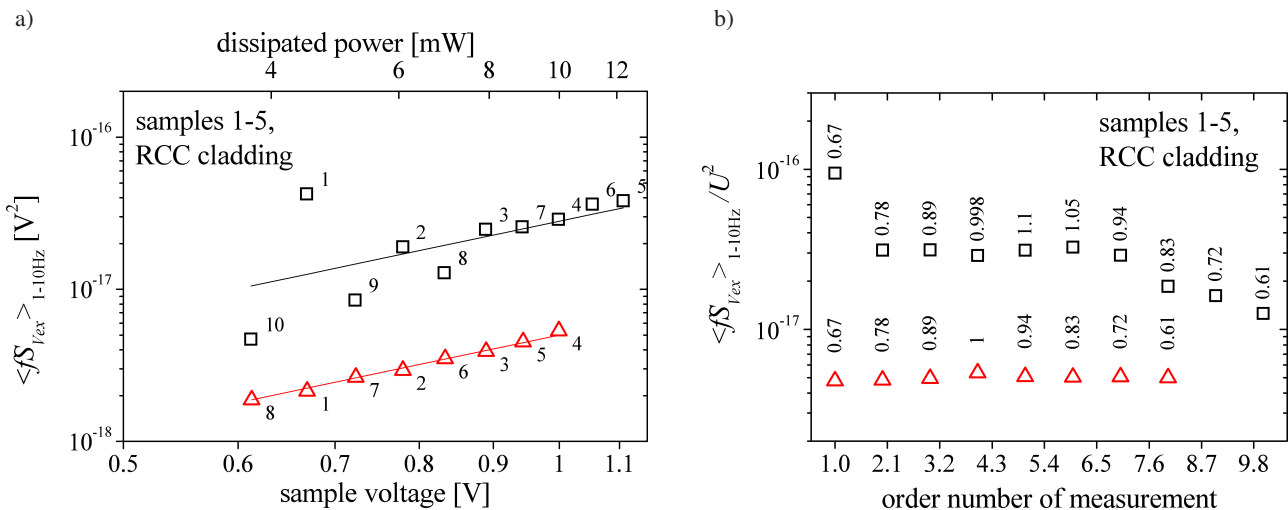

Fig. 5. Data from two experiments performed on the same samples' pair with 17 days break. Squares (triangles) are the data points derived from the first (second) experiment. a) The noise intensity vs. sample voltage (points) and their quadratic approximations (lines). The labels of the points are the order numbers of the successive data points acquired during the experiment. b) Data from Fig. 5a plotted as a normalized noise intensity vs. order number. The labels of the points show the proper sample voltages

5. Noise intensity

Using dependencies of noise intensity on sample voltage, shown in Fig. 4, it is possible to calculate parameters describing noise properties of a resistive material. Although current noise index (CNI) is widely used by the manufacturers of the electronic materials and components for describing their noise properties [6] with respect to $1/f$ noise, its value, depending on the sample volume, is useless in comparative studies. Admittedly, the direct measurement of CNI is possible by the use of standard meters like Quan-Tech 315B called *resistance noise test system*, but noise of the investigated Ni-P resistors in the specified power limit does not exceed the system noise of the meter. Instead of CNI, material noise intensity,

$C \equiv \Omega \langle fS_{V_{ex}} \rangle_{\Delta f} U^{-2}$, where Ω is the resistive film volume and U is the sample voltage, has been used as the convenient measure of noise properties of the material in the limit when $1/f$ noise is dominant. The parameter C , which is independent of the frequency, the sample volume and the voltage, describes noise properties of the material itself, giving a quantitative measure of the noise intensity, which is very useful for further comparative studies of noise properties of the electronic materials and components with respect to $1/f$ noise.

For calculations of the value of parameter C the frequency range Δf from 1 to 10 Hz and the sample volume $\Omega = 2.5 \cdot 10^{-14} \text{ m}^3$ have been taken. The values of C , averaged for each substrate, have been gathered in Table 1 together

Noise properties of thin-film Ni-P resistors embedded in printed circuit boards

with the equivalent values of CNI obtained from the following relation [5]:

$$\text{CNI} = 10 \log (10^{12} S \ln 10),$$

where

$$S = \langle f S_{V_{ex}} \rangle_{\Delta f} U^{-2} = C/\Omega.$$

Furthermore, the parameter $K = C/\rho$ is introduced for the comparison of noise properties of materials of different resistivities ρ . It is considered as the figure of merit and also as an indicator of a technology quality with respect to $1/f$ noise. The values of the parameter K obtained for the studied in this work Ni-P embedded resistors have been also included in Table 1 and they range between $2 \cdot 10^{-14}$ and $5 \cdot 10^{-13} \mu\text{m}^2/\Omega$. On the other hand, in [7] $K = 5 \cdot 10^{-13} \mu\text{m}^2/\Omega$ has been found for thin films made of Au, poly-Si, and poly-SiGe. However, thick-film resistors have been found to be of poorer quality and are described by $K = 2.5 \cdot 10^{-11} \mu\text{m}^2/\Omega$, $4 \cdot 10^{-10} \mu\text{m}^2/\Omega$ for films based on RuO_2 , $K = 2 \cdot 10^{-9} \mu\text{m}^2/\Omega$ and $2 \cdot 10^{-8} \mu\text{m}^2/\Omega$ for $\text{Bi}_2\text{Ru}_2\text{O}_7$ and CaRuO_3 [8], respectively.

It has been observed during the experiments that the ageing process took place in the samples, resulting in the change of the local currents distribution what makes (i) a relatively large short-time fluctuation of the measured spectra (what forces into long time of the consecutive spectra averaging), and (ii) a long-time drift of the spectra noticed in a few samples during the successive experiments. A good illustration of the spectra evolution in time is given in Fig. 5, where noise intensities calculated in the frequency range 1 Hz – 10 Hz from two experiments, which were performed with 17 days break, have been plotted vs. the sample voltage (Fig. 5a) or vs. the order number of the measurement (Fig. 5b), which also relates to time. The data that refer to the pair of the samples 1 and 5 from the substrate with the RCC cladding have been presented in the plots of Fig. 5. The data deriving from the first experiment, plotted with squares, exhibit the relatively large spread on the plot vs. the sample voltage (Fig. 5a). However, the same set of the data, plotted as the normalized noise intensity vs. the order number, indicate the descending tendency (Fig. 5b). Finally, the data from the second experiment (marked with triangles) denote that the electrical properties are stable.

6. Summary

Low-frequency noise of the planar PCB-embedded Ni-P thin-film resistors has been measured at room temperature. Both the small value of the surface power dissipation limit and the small resistance of the sample resistors implied the usage of the low-noise transformer and DC bridge configuration, that makes the measurement more complicated but the sensitivity

improvement of the measurement system as well as the reduction of interferences have been achieved at the same time. Moreover, a standard noise meter like Quan-Tech 315B could not be used due to the relatively large system noise of itself.

$1/f$ noise caused by resistance fluctuations has been found as the dominant component in the resistors studied in this work. It has been also observed that the ageing processes in the studied samples led to the stabilization of their electrical properties. Comparing the measured resistance of the samples and the nominal resistance of the resistive foil, one may deduce that the contact resistance is minor, not larger than 10 % of the total resistance. Next, assuming small contribution of the contact noise, we may conclude that noise intensity of the films of the Ni-P foil is close to that observed in the thin films of Au, poly-Si and poly-SiGe, for which similar values of the parameter K have been found.

Acknowledgements. The work has been supported from Grant DEC-2011/01/B/ST7/06564 funded by National Science Centre (Poland) and from Rzeszow University of Technology Project U-235/DS. Studies have been performed with the use of equipment purchased in the project No POPW.01.03.00-18-012/09 from the Structural Funds, The Development of Eastern Poland Operational Programme co-financed by the European Union, the European Regional Development Fund.

REFERENCES

- [1] www.ohmega.com (Ohmega Technologies Inc. website).
- [2] S.K. Bhattacharya and R.R. Tummala, "Next generation integral passives: materials, processes, and integration of resistors and capacitors on PWB substrates", *J. Mater. Sci.: Mat. in Electronics* 11, 253–268 (2000).
- [3] A. Dziejczak, A. Kłossowicz, P. Winiarski, K. Nitsch, T. Piasecki, G. Koziół, and W. Stęplewski, "Chosen electrical properties and stability of passive components embedded in printed circuit boards", *Electrotechnical Review* 87 (10), 39–44 (2011).
- [4] W. Stęplewski, T. Serzysko, K. Janeczek, J. Borecki, A. Dziejczak, K. Nitsch, and T. Piasecki, "Testing of electrical parameters of thin-film resistors embedded in printed circuit boards", *Electronics – Constructions, Technologies, Applications* 52 (7), 124–127 (2011).
- [5] A. Kolek, *Experimental Methods of Low-Frequency Noise*, Publishing House of Rzeszow University of Technology, Rzeszów, 2006, (in Polish).
- [6] *Test Method Standard Electronic and Electrical Component Parts*, MIL-STD-202G, 2002.
- [7] L.K.J. Vandamme and H.J. Casier, "The $1/f$ noise versus sheet resistance in poly-Si is similar to poly-SiGe resistors and Au-layers", *Proc 34th Eur. Solid-State Device Research Conf.* 1, 21–23 (2004).
- [8] A.W. Stadler, "Noise properties of thick-film resistors in extended temperature range", *Microelectronics Reliability* 51, 1264–1270 (2011).