

# Theoretical analysis of air-fuel mixture formation in the combustion chambers of the gas engine with two-stage combustion system

A. JAMROZIK\* and W. TUTAK

Institute of Thermal Machinery, Czestochowa University of Technology, 21 Armii Krajowej Ave., 42-200 Czestochowa, Poland

**Abstract.** The results of theoretical analysis of a mixture formation process during the compression stroke in a prechamber of the IC (internal combustion) gas engine with the stratified mixtures two-stage combustion system were presented in the paper. The course of excess air-fuel ratio changes in prechamber at ignition time  $\lambda_{kz}$  in function of degree of the mixture condensation during the compression stroke  $\Phi$  expressing quotient of a temporary cylinder and prechamber volume and maximal value of the volume were estimated. Research concerning  $\lambda_{kz}$  sensitivity on changes of rich combustible mixture composition delivered to the prechamber by the additional fuel supply system  $\lambda_{ko}$ , mixture composition in cylinder  $\lambda_c$  and degree of filling a prechamber with the rich combustible mixture  $\xi$  were performed. According to numerical calculations it was proved that the real gas engine with the two-stage combustion system at equal degree requires exact regulation of the three analysed values.

**Key words:** two-stage combustion system, prechamber, stratified mixtures.

## 1. Introduction

The problem of air pollution by the exhaust gas of piston engines, particularly in highly motorised countries, is presently one of the most important aspects in the struggle for the protection of the natural environment. The necessity of limiting the toxic components of the exhaust gas and reducing fuel consumption has resulted in a change in the combustion engine design and development. Reducing emissions of toxic components in exhaust gases of piston engines can be achieved by proper organization of the combustion process, through the use of additives for fuels and by the neutralization of exhaust and burning as a result of purification devices outside the engine [1, 2]. Lean mixture burning results in a decrease in temperature of the combustion process and is one of the methods of limiting nitric oxide emission. It also increases the engine efficiency. Increasing the excess air results in a decrease in engine performance expressed by a decrease in the maximum indicated mean effective pressure and maximum torque and an increase in emissions of hydrocarbons in the exhaust [3]. Conventional spark-ignition engines work properly only in a narrow range of excess air. Exceeding this range toward the richer mixtures, on the one hand, is associated with the phenomenon of knocking and an increase in  $\text{NO}_x$  emissions, and exceeding this range toward the lean mixtures is associated with increasing the non-repeatability of successive cycles of engine operation, misfire and an increase in emissions of HC and CO [4, 5]. An effective method to improve the lean mixture combustion process is a two-stage system of stratified mixture combustion in an engine with a prechamber. In such a system, the combustion chamber consists of two parts: the main chamber in the cylinder of the engine and the prechamber in the engine head connected with the main

chamber by a connecting duct. A lean mixture prepared in the engine inlet system ( $\lambda = 1.5\text{--}3.0$ ) is aspirated to the cylinder. However, a stoichiometric mixture ( $\lambda = 1.0$ ) is delivered to the prechamber. The stoichiometric mixture ignition by spark discharge occurs in the prechamber and large amounts of CO and HC and slight amounts of  $\text{NO}_x$  are produced. As a result of the pressure increase, the burning charge of the prechamber is forced by the connecting duct to the main combustion chamber, where many moving ignition kernels develop. As a consequence, the lean flammable mixture, which could not be ignited by spark discharge, ignites in many regions. The ignition is fast enough to provide high engine cycle efficiency and avoid the disadvantages connected with combustion during the expansion stroke. At the time of the main combustion, slight amounts of  $\text{NO}_x$  are produced, and particles of CO and HC are burnt [6]. One of the first attempts to study and analysis the effectiveness of ignition and combustion lean mixtures in the engine with a prechamber was preliminary: the ignition system of the pilot flame torch. This system was developed and patented in 1963 and 1966 by L.A. Gussak [7, 8]. This system is characterised by the use of a prechamber of small dimensions (of the third inlet valve and the spark plug), which serves as a spark chamber, and lean combustion in the cylinder. The two-stage combustion system in the engine compartment with a small spark was the subject of studies conducted since 1978 in Berkeley at the University of California by the team of Prof. Antoni K. Oppenheim [9, 10]. The research developed a system called controlled burning, in which the lean combustion in the cylinder followed the PJC generator pilot flame (pulsed jet combustion). The proposed concept of burning proved beneficial in terms of engine thermal efficiency and emissions of CO and HC. Almost all of the major global automotive companies have

\*e-mail: jamrozik@imc.pcz.czyst.pl

conducted, or maintained, work on a two-stage combustion process of stratified mixtures. In part one, the research resulted in the implementation of the new engine design for mass production. The most well-known engine of this group was already developed in the seventies by Honda CVCC system (compound vortex controlled combustion) [11]. In the automotive industry, this group also includes solution companies: Ford, General Motors, Volkswagen, Walker, Eaton, Heintz, Nilov, Porsche, Toyota, and Mitsubishi [12, 13]. Currently, most automotive SI internal combustion engines with liquid fuel and gas engines with a cylinder diameter up to about 200 mm with a stratification fuel mixture by altering the design of the combustion chamber does not allow the reduction of toxic emissions to the level imposed by the European standards (EURO IV and V) [14]. Creation and combustion of stratified mixtures in automotive engines initially implemented in the prechamber system (Honda CVCC) were abandoned in favor of targeted directed fuel injection to the combustion chamber (Mitsubishi GDI - gasoline direct injection) [15–17]. Currently, a two-stage combustion system for stratified mixtures with a prechamber is used primarily in modern, stationary, supercharged gas engines of medium and high power operating at a constant speed and focused mainly on the use of stationary, electricity generation and gas compression. The two-stage combustion of lean gas mixtures using the sectional combustion chamber is used in modern stationary gas engines with high power ignition cylinder diameters exceeding 200 mm inter alia by the Austrian company Jenbacher AG [18], Danish German MAN B & W Høleby [19], a Finnish Wärtsilä NSD Corporation [20] and in the US by the Waukesha Engine Dresser [21] and Caterpillar Inc. [22].

Better knowledge of mixture formation processes in two-stage combustion systems could have a great influence on gas engines with prechamber. The aim of this research was the analysis and better understanding of stratified mixtures formation processes in stationary gas engines of medium and high power.

## 2. Description of the mathematical model

The two-stage combustion system of heterogeneous mixtures, during the compression stroke, the lean mixture in the cylinder is injected into the prechamber. This causes dilution and depletion located there rich mixture. This rich mixture is produced by the additional power supply system. Fuel dose into the prechamber should be so that at the time of ignition of excess air-fuel ratio in the chamber was about 1.0. The zero-dimensional model was created in order to better understanding the mixture creation of gaseous propane-butane with air in the prechamber. This model partly based on the assumptions presented in the work [10], designed to liquid fuel mixtures. This model the changes in the composition of fuel mixture in the prechamber takes into account. This is due to the delivery to the chamber pure gas fuel or riches mixture. This mixture in the prechamber is diluted by lean mixture delivered from cylinder during the compression stroke. In model studies, the

impact of a few values on the excess air-fuel ratio of mixture in the prechamber at the ignition time:

- excess air-fuel ratio of rich mixture delivered to the prechamber before the start of the compression stroke –  $\lambda_{ko}$ ,
- degree of filling of the prechamber by a rich combustible mixture –  $\xi$ ,
- excess air-fuel ratio of lean mixture in the cylinder and delivered to the prechamber during the compression stroke –  $\lambda_c$ ,
- degree of the mixture condensation during the compression stroke –  $\Phi$ .

Computational model diagram shown in Fig. 1.

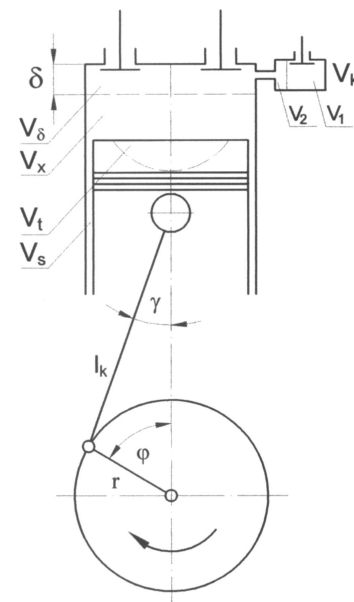

- $V_k$  – prechamber volume [m<sup>3</sup>],
- $V_1$  – mixture volume in the prechamber at ignition time, [m<sup>3</sup>],
- $V_2$  – volume of the prechamber taken by the mass of the mixture, which inflow from the cylinder during the compression [m<sup>3</sup>],
- $V_\delta$  – volume of combustion chamber at TDC [m<sup>3</sup>],
- $V_x$  – instantaneous cylinder volume [m<sup>3</sup>],
- $V_t$  – volume of combustion chamber in the piston [m<sup>3</sup>],
- $V_s$  – displacement [m<sup>3</sup>].

Fig. 1. Computational model diagram

Compression ratio of engine:

$$\varepsilon = \frac{V_k + V_\delta + V_s + V_t}{V_k + V_\delta + V_t} \quad (1)$$

Volume of cylinder at BDC:

$$V_c = V_{ck} + \frac{\pi D^2}{4} S, \quad (2)$$

where  $S$  is stroke [m],  $V_{ck}$  is a total volume above the piston at TDC [m<sup>3</sup>],  $D$  is cylinder diameter [m],

$$S = r \left( 1 + \frac{\lambda_w}{2} \sin^2 \varphi - \cos \varphi \right), \quad (3)$$

where  $\lambda_w$  is crank radius to connecting rod length ratio,

$$\frac{\pi D^2}{4} r = \frac{V_s}{2}, \quad V_{ck} = \frac{V_s}{\varepsilon - 1} \quad (4)$$

Instantaneous cylinder volume:

$$V_c = V_s \left( \frac{1}{\varepsilon - 1} + \frac{1}{2} \left( 1 + \frac{\lambda_w}{2} \sin^2 \varphi - \cos \varphi \right) \right). \quad (5)$$

### 2.1. Changing in the medium volume in the prechamber.

It was assumed that the process of supplying a rich combustible mixture to prechamber ends in the BDC.

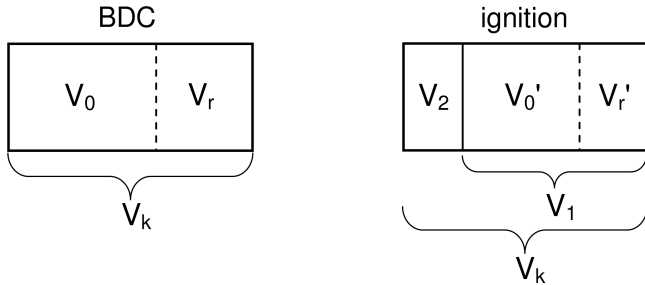

Fig. 2. Content of prechamber in initial conditions at BDC and at ignition moment

Where  $V_0$  is volume of rich mixture in the prechamber at BDC [ $\text{m}^3$ ],  $V_r$  is volume of the rest of exhaust in the prechamber at BDC [ $\text{m}^3$ ],  $V_0'$  is volume of rich mixture in the prechamber at ignition time [ $\text{m}^3$ ],  $V_r'$  is volume of rest of exhaust at ignition time [ $\text{m}^3$ ].

In the prechamber with  $V_k$  volume, at initial conditions (BDC), two zones can be extracted:  $V_0$  and  $V_r$ ,

$$V_k = V_0 + V_r. \quad (6)$$

In the volume  $V_0$  is a rich mixture supplied to the prechamber by additional supply system, volume  $V_r$  takes the rest of the exhaust from the previous engine cycle.

The degree of filling of the prechamber in a rich mixture at the beginning of the compression stroke in BDC (Fig. 2):

$$\xi = \frac{V_0}{V_k}. \quad (7)$$

At the time of ignition  $\varphi = \varphi_z$  in the prechamber three zones can be noticed:  $V_2$ ,  $V_0'$  and  $V_r'$ .  $V_0'$  and  $V_r'$  zones formed  $V_1$  area, which at the beginning conditions at BDC occupied whole volume of the prechamber  $V_k$ . The  $V_2$  zone contains lean mixture which inflow during compression stroke from cylinder.

$$V_k = V_2 + V_1, \quad (8)$$

$$V_k = V_2 + V_0' + V_r'. \quad (9)$$

It was assumed that in the initial conditions at BDC ( $\varphi = 0$ ) the pressure and temperature of the combustible mixture throughout the whole prechamber volume are the same and there are equal to the pressure and temperature in the cylinder. Also assumed that the fluid flow from the cylinder to the prechamber is ideal and without losses, and at the time of ignition ( $\varphi = \varphi_z$ ) the pressure and temperature of the mixture in the entire volume of prechamber and the cylinder are the same. Equation of the gas state for the prechamber in the

initial conditions, when  $\varphi = 0$  and the moment of ignition, when  $\varphi = \varphi_z$  are:

$$p_o V_k = n_{o0}(MR)T_o, \quad (10)$$

$$p_z V_1 = n_{o1}(MR)T_z, \quad (11)$$

where  $p_o$  is pressure in the prechamber at initial conditions at BDC [MPa],  $n_{o0}$  is amount of moles of mixture in the prechamber at initial conditions at BDC [kmol mixture], (MR) is universal gas constant [J/kmol K],  $T_o$  is temperature in the prechamber at initial conditions at BDC [K],  $p_z$  is pressure in the prechamber at ignition time [MPa],  $n_{o1}$  is amount of moles of mixture in the prechamber at ignition time, which took whole volume of the prechamber [kmol mixture],  $T_z$  is temperature in the prechamber at ignition time [K],

$$n_{o0}(MR) = n_{o1}(MR), \quad (12)$$

$$\frac{T_z p_o}{T_o p_z} = \frac{V_1}{V_k}. \quad (13)$$

Equation of the gas state for volume above piston at initial conditions at BDC, where  $\varphi = 0$  and ignition time; where  $\varphi = \varphi_z$ :

$$p_o V_m = n_{m0}(MR)T_o, \quad (14)$$

$$p_z V_z = n_{m1}(MR)T_z, \quad (15)$$

where  $V_m$  is maximum volume above piston in initial conditions at BDC [ $\text{m}^3$ ],  $n_{m0}$  is amount of moles of medium of the maximum volume above piston at initial conditions at BDC [kmol mixture],  $V_z$  is whole volume above piston at ignition time [ $\text{m}^3$ ],  $n_{m1}$  is amount of mixture moles of whole volume above piston at ignition time [kmol mixture].

$$n_{m0}(MR) = n_{m1}(MR), \quad (16)$$

$$\frac{T_z p_o}{T_o p_z} = \frac{V_z}{V_m}. \quad (17)$$

Comparing Eqs. (13) and (17) was obtained:

$$\frac{V_1}{V_k} = \frac{V_z}{V_m} = \frac{T_z p_o}{T_o p_z}, \quad (18)$$

$$\frac{V_z}{V_m} = \frac{V_k + V_\delta + V_x + V_t}{V_k + V_\delta + V_s + V_t}, \quad (19)$$

Instantaneous cylinder volume:

$$V_x = \frac{V_s}{2} \left( 1 + \frac{\lambda_w}{2} \sin^2 \varphi - \cos \varphi \right), \quad (20)$$

where  $\lambda_w$  is a crank radius to connecting rod length ratio.

After the substitution:

$$\frac{V_z}{V_m} = \frac{V_k + V_\delta + V_t + V_s \frac{1}{2} \Omega}{V_k + V_\delta + V_s + V_t}, \quad (21)$$

$$\Omega = 1 + \frac{\lambda_w}{2} \sin^2 \varphi - \cos \varphi, \quad (22)$$

$$\frac{V_z}{V_m} = \frac{\frac{V_k}{a^*} + \frac{V_\delta}{a^*} + \frac{V_t}{a^*} + \frac{V_s}{a^*} \frac{1}{2} \Omega}{\frac{V_k + V_\delta + V_t + V_s}{V_k + V_\delta + V_t}} \quad (23)$$

where

$$a^* = V_k + V_\delta + V_t.$$

Compression ratio:

$$\varepsilon = \frac{V_k + V_\delta + V_s + V_t}{V_k + V_\delta + V_t}, \quad (24)$$

$$\frac{V_z}{V_m} = \frac{\frac{1}{2}\Omega \left( \frac{2V_k}{\Omega(a^*)} + \frac{2V_\delta}{\Omega(a^*)} + \frac{2V_t}{\Omega(a^*)} + \frac{V_s}{a^*} \right)}{\varepsilon}, \quad (25)$$

$$\frac{V_z}{V_m} = \frac{\frac{1}{2}\Omega \left( \frac{2}{\Omega} + \frac{V_s}{a^*} \right)}{\varepsilon} = \frac{1 + \frac{1}{2}\Omega \frac{V_s}{a^*}}{\varepsilon}, \quad (26)$$

$$\varepsilon = \frac{V_k + V_\delta + V_t + V_s}{V_k + V_\delta + V_t} = 1 + \frac{V_s}{V_k + V_\delta + V_t}, \quad (27)$$

$$\frac{V_z}{V_m} = \frac{1 + \frac{1}{2}\Omega(\varepsilon - 1)}{\varepsilon}, \quad (28)$$

$$\frac{V_z}{V_m} = \frac{1}{\varepsilon} + \frac{1}{2} \left( 1 + \frac{\lambda_w}{2} \sin^2 \varphi - \cos \varphi \right) \frac{\varepsilon - 1}{\varepsilon} = \Phi, \quad (29)$$

where

$$a^* = V_k + V_\delta + V_t,$$

According to Eq. (18) the initial volume of mixture filling the prechamber at BDC:

$$V_1 = V_k \frac{V_z}{V_m}. \quad (30)$$

Finally, the change of initial volume of filling the prechamber at BDC:

$$V_1 = V_k \left( \frac{1}{\varepsilon} + \frac{1}{2} \left( 1 + \frac{\lambda_w}{2} \sin^2 \varphi - \cos \varphi \right) \frac{\varepsilon - 1}{\varepsilon} \right), \quad (31)$$

$$V_1 = V_k \Phi, \quad (32)$$

where  $\varepsilon$  is compression ratio,  $\Phi$  is degree of the mixture condensation during the compression stroke.

The degree of the mixture condensation during the compression stroke  $\Phi$  expresses quotient of instantaneous cylinder and prechamber volume and maximal volume above the piston at BDC:

$$\Phi = \frac{1}{\varepsilon} + \frac{1}{2} \left( 1 + \frac{\lambda_w}{2} \sin^2 \varphi - \cos \varphi \right) \frac{\varepsilon - 1}{\varepsilon}. \quad (33)$$

Taking into account Eqs. (18) and (32):

$$\frac{V_1}{V_k} = \frac{V_z}{V_m} = \frac{T_z p_o}{T_o p_z} = \Phi. \quad (34)$$

**2.2. The excess air-fuel ratio in the prechamber at the ignition time.** Excess air-fuel ratio in prechamber at ignition time, when  $\varphi = \varphi_z$ , is:

$$\lambda_{kz} = \frac{n_{O2kz}}{0.21 L_t n_{pkz}}, \quad (35)$$

where  $L_t$  is stoichiometric air demand [kmol air/kmol fuel],  $n_{O2kz}$  is amount of oxygen moles in the prechamber at ignition time [kmol  $O_2$ ],  $n_{pkz}$  is amount of fuel moles in the prechamber at the ignition time [kmol fuel].

Amount of oxygen moles in the prechamber at ignition time:

$$n_{O2kz} = n_{O2k} + n_{O2w} + n_{O2r}, \quad (36)$$

where  $n_{O2k}$  is amount of oxygen moles of mixture in the prechamber at BDC [kmol  $O_2$ ],  $n_{O2w}$  is amount of oxygen moles of mixture, which was delivered from cylinder to prechamber during compression stroke [kmol  $O_2$ ],  $n_{O2r}$  is amount of oxygen moles in the rest of the exhaust in the prechamber from the previous engine cycle [kmol  $O_2$ ].

Amount of mixture moles in the prechamber in the initial conditions at BDC:

$$n_0 = n_{ko} + n_{pko}, \quad (37)$$

$$n_0 = n_{N2k} + n_{O2k} + n_{pko}, \quad (38)$$

$$n_0 = n_{O2k} \left( \frac{n_{N2k}}{n_{O2k}} + 1 + \frac{n_{pko}}{n_{O2k}} \right), \quad (39)$$

$$n_0 = n_{O2k} \left( \frac{0.79}{0.21} + 1 + \frac{n_{pko}}{n_{O2k}} \right), \quad (40)$$

$$n_0 = n_{O2k} \left( 4.76 + \frac{n_{pko}}{n_{O2k}} \right), \quad (41)$$

where  $n_{ko}$  is amount of air moles in the prechamber at BDC [kmol air],  $n_{pko}$  is amount of fuel moles in the mixture in the prechamber at BDC [kmol fuel],  $n_{N2k}$  is amount of nitrogen moles in the mixture in the prechamber at BDC [kmol  $N_2$ ].

Excess air-fuel ratio of mixture delivered to the prechamber at BDC:

$$\lambda_{ko} = \frac{n_{O2k}}{0.21 L_t n_{pko}}. \quad (42)$$

Amount of mixture moles in the prechamber in the initial conditions at BDC:

$$n_0 = n_{O2k} \left( 4.76 + \frac{1}{0.21 L_t \lambda_{ko}} \right), \quad (43)$$

$$n_0 = n_{O2k} \frac{1 + L_t \lambda_{ko}}{0.21 L_t \lambda_{ko}}. \quad (44)$$

From the state equation, amount of mixture moles in the prechamber in the initial conditions at BDC:

$$n_0 = V_k \frac{p_o \xi}{(MR) T_o}, \quad (45)$$

Comparing Eqs. (44) and (45) the number of moles of oxygen in the mixture in the prechamber at BDC is received:

$$n_{O2k} = \frac{V_k p_o 0.21 \xi L_t \lambda_{ko}}{(MR) T_o (1 + L_t \lambda_{ko})}. \quad (46)$$

Amount of fuel moles of mixture in the prechamber at BDC:

$$n_{pko} = \frac{V_k p_o \xi}{(MR) T_o (1 + L_t \lambda_{ko})}. \quad (47)$$

Amount of mixture moles which inflow to the prechamber from the cylinder during compression stroke:

$$n_w = n_{kw} + n_{pkw}, \quad (48)$$

$$n_w = n_{N2w} + n_{O2w} + n_{pkw}, \quad (49)$$

$$n_w = n_{O2w} \left( \frac{n_{N2w}}{n_{O2w}} + 1 + \frac{n_{pkw}}{n_{O2w}} \right), \quad (50)$$

*Theoretical analysis of air-fuel mixture formation in the combustion chambers of the gas engine...*

$$n_w = n_{O2w} \left( 4.76 + \frac{n_{pkw}}{n_{O2w}} \right), \quad (51)$$

where  $n_{kw}$  is amount of air moles which was injected from cylinder to the prechamber during compression stroke [kmol air],  $n_{pkw}$  is amount of fuel moles in the mixture which inflow from cylinder to the prechamber during compression stroke [kmol fuel],  $n_{N2w}$  is amount of nitrogen moles in the mixture which inflow from cylinder to the prechamber during compression stroke [kmol  $N_2$ ].

It was assumed that in the cylinder the mixture excess air-fuel ratio does not change and at the beginning is equal to the value at the ignition time:

$$\lambda_{co} = \lambda_{cz} = \lambda_c. \quad (52)$$

Excess air-fuel ratio of mixture in the cylinder:

$$\lambda_c = \frac{n_{O2w}}{0.21 L_t n_{pkw}}. \quad (53)$$

Amount of mixture moles which inflow from cylinder to the prechamber during compression stroke:

$$n_w = n_{O2w} \left( 4.76 + \frac{1}{0.21 L_t \lambda_c} \right), \quad (54)$$

$$n_w = n_{O2w} \frac{1 + L_t \lambda_c}{0.21 L_t \lambda_c}. \quad (55)$$

On the basis of state equation, amount of mixture moles which inflow from cylinder to the prechamber during compression stroke:

$$n_w = (V_k - V_1) \frac{p_z}{(MR)T_z}, \quad (56)$$

Comparing Eqs. (55) and (56), amount of oxygen moles in the mixture, which inflow from the cylinder into the prechamber during the compression stroke, can be obtained:

$$n_{O2w} = (V_k - V_1) \frac{p_z}{(MR)T_z} \frac{0.21 L_t \lambda_c}{1 + L_t \lambda_c}. \quad (57)$$

Transforming the relationship (13) is:

$$V_1 = V_k \frac{T_z p_o}{T_o p_z}, \quad (58)$$

$$n_{O2w} = V_k \left( 1 - \frac{T_z p_o}{T_o p_z} \right) \frac{p_z}{(MR)T_z} \frac{0.21 L_t \lambda_c}{1 + L_t \lambda_c}, \quad (59)$$

$$n_{O2w} = \frac{V_k p_z}{(MR)T_z} \frac{0.21 L_t \lambda_c}{1 + L_t \lambda_c} - \frac{V_k p_o}{(MR)T_o} \frac{0.21 L_t \lambda_c}{1 + L_t \lambda_c}. \quad (60)$$

Amount of fuel moles in mixture, which inflow from cylinder to the prechamber during compression stroke:

$$n_{pkw} = (V_k - V_1) \frac{p_z}{(MR)T_z} \frac{1}{1 + L_t \lambda_c}, \quad (61)$$

$$n_{pkw} = V_k \left( 1 - \frac{T_z p_o}{T_o p_z} \right) \frac{p_z}{(MR)T_z} \frac{1}{1 + L_t \lambda_c}, \quad (62)$$

$$n_{pkw} = \frac{V_k p_z}{(MR)T_z} \frac{1}{1 + L_t \lambda_c} - \frac{V_k p_o}{(MR)T_o} \frac{1}{1 + L_t \lambda_c}. \quad (63)$$

Amount of oxygen moles in the rest of exhaust in the prechamber from the previous engine cycle:

$$n_{O2r} = n_r u_{O2}, \quad (64)$$

$$n_{O2r} = \frac{V_k(1-\xi) p_o}{(MR) T_o} u_{O2}, \quad (65)$$

where  $n_r$  is amount of exhaust rest moles [kmol exhaust rest],  $u_{O2}$  is part of oxygen in exhaust gas in the prechamber from the previous engine cycle.

It is assumed that the proportion of oxygen in the exhaust gas remaining in the prechamber from the previous engine cycle is dependent on the value of excess air-fuel ratio in the cylinder.

Amount of nitrogen in the exhaust:

$$N_2 = 0.79 L_t \lambda_c. \quad (66)$$

Amount of oxygen in the exhaust (for  $\lambda_c \geq 1$ ):

$$O_2 = 0.21 L_t (\lambda_c - 1). \quad (67)$$

The reactions of gaseous fuel combustion of propane-butane [23]:

- methane  $CH_4$ :  $CH_4 + 2O_2 \rightarrow CO_2 + 2H_2O$ ,
- ethane  $C_2H_6$ :  $C_2H_6 + 3.5O_2 \rightarrow 2CO_2 + 3H_2O$ ,
- propane  $C_3H_8$ :  $C_3H_8 + 5O_2 \rightarrow 3CO_2 + 4H_2O$ ,
- butane  $C_4H_{10}$ :  $C_4H_{10} + 6.5O_2 \rightarrow 4CO_2 + 5H_2O$ .

Amount of exhaust:

$$S = L_t(\lambda_c - 0.21) + 3CH_4 + 5C_2H_6 + 7C_3H_8 + 9C_4H_{10}, \quad (68)$$

where  $CH_4$  is molar fraction of methane in the fuel [kmol  $CH_4$ /kmol fuel],  $C_2H_6$  is molar fraction of ethane in the fuel [kmol  $C_2H_6$ /kmol fuel],  $C_3H_8$  is molar fraction of propane in the fuel [kmol  $C_3H_8$ /kmol fuel],  $C_4H_{10}$  is molar fraction of butane in the fuel [kmol  $C_4H_{10}$ /kmol fuel].

Fraction of oxygen in the rest of exhaust gas remaining in the prechamber from the previous engine cycle:

$$u_{O2} = \frac{0.21 L_t (\lambda_c - 1)}{L_t (\lambda_c - 0.21) + 3CH_4 + 5C_2H_6 + 7C_3H_8 + 9C_4H_{10}}. \quad (69)$$

In order to simplify the notation:

$$U_{CH} = 3CH_4 + 5C_2H_6 + 7C_3H_8 + 9C_4H_{10}. \quad (70)$$

Finally obtained:

$$u_{O2} = \frac{0.21 L_t (\lambda_c - 1)}{L_t (\lambda_c - 0.21) + U_{CH}}. \quad (71)$$

Finally, amount of oxygen moles in the rest of exhaust in prechamber:

$$n_{O2r} = \frac{V_k(1-\xi) p_o}{(MR) T_o} \frac{0.21 L_t (\lambda_c - 1)}{L_t (\lambda_c - 0.21) + U_{CH}}. \quad (72)$$

Amount of oxygen moles in the prechamber at ignition time:

$$n_{O2kz} = n_{O2k} + n_{O2w} + n_{O2r}. \quad (73)$$

Substituting Eqs. (46), (60) and (72) the number of oxygen moles in the prechamber at the ignition time was obtained:

$$n_{O2kz} = \frac{0.21 V_k L_t}{(MR)} \left( \frac{p_o}{T_o} \frac{\xi \lambda_{ko}}{1 + L_t \lambda_{ko}} + \frac{p_z}{T_z} \frac{\lambda_c}{1 + L_t \lambda_c} - \frac{p_o}{T_o} \frac{\lambda_c}{1 + L_t \lambda_c} + \frac{p_o}{T_o} \frac{(1-\xi)(\lambda_c - 1)}{L_t (\lambda_c - 0.21) + U_{CH}} \right). \quad (74)$$

Amount of fuel moles in the prechamber at ignition time:

$$n_{pkz} = n_{pko} + n_{pkw}. \quad (75)$$

Substituting Eqs. (47) and (63) the number of fuel moles in the prechamber at the ignition time was obtained:

$$n_{pkz} = \frac{V_k}{(MR)} \left( \frac{p_o}{T_o} \frac{\xi}{1 + L_t \lambda_{ko}} + \frac{p_z}{T_z} \frac{1}{1 + L_t \lambda_c} - \frac{p_o}{T_o} \frac{1}{1 + L_t \lambda_c} \right). \quad (76)$$

Excess air-fuel ratio in the prechamber at ignition time, for  $\varphi = \varphi_z$ :

$$\lambda_{kz} = \frac{n_{O2kz}}{0.21 L_t n_{pkz}}, \quad (77)$$

$$\lambda_{kz} = \frac{\frac{0.21 V_k L_t}{(MR)} \left( \frac{p_o}{T_o} \frac{\xi \lambda_{ko}}{1 + L_t \lambda_{ko}} + \frac{p_z}{T_z} \frac{\lambda_c}{b^*} - \frac{p_o}{T_o} \frac{\lambda_c}{b^*} + \frac{p_o}{T_o} \frac{(1-\xi)(\lambda_c-1)}{c^*} \right)}{0.21 L_t \frac{V_k}{(MR)} \left( \frac{p_o}{T_o} \frac{\xi}{1 + L_t \lambda_{ko}} + \frac{p_z}{T_z} \frac{1}{b^*} - \frac{p_o}{T_o} \frac{1}{b^*} \right)}, \quad (78)$$

where

$$b^* = 1 + L_t \lambda_c, \quad c^* = L_t (\lambda_c - 0.21) + U_{CH}.$$

Multiplying the numerator and denominator by  $\frac{T_z}{p_z}$ :

$$\lambda_{kz} = \frac{\frac{T_z}{T_o} \frac{p_o}{p_z} \left( \frac{\xi \lambda_{ko}}{1 + L_t \lambda_{ko}} - \frac{\lambda_c}{1 + L_t \lambda_c} + \frac{(1-\xi)(\lambda_c-1)}{L_t (\lambda_c - 0.21) + U_{CH}} \right) + \frac{\lambda_c}{1 + L_t \lambda_c}}{\frac{p_o}{T_o} \frac{T_z}{p_z} \left( \frac{\xi}{1 + L_t \lambda_{ko}} - \frac{1}{1 + L_t \lambda_c} \right)}. \quad (79)$$

Substituting the relationship (34):

$$\frac{T_z}{T_o} \frac{p_o}{p_z} = \frac{V_1}{V_k} = \Phi. \quad (80)$$

Finally, excess air-fuel ratio in the prechamber at ignition time:

$$\lambda_{kz} = \frac{\Phi \left( \frac{\xi \lambda_{ko}}{1 + L_t \lambda_{ko}} - \frac{\lambda_c}{1 + L_t \lambda_c} + \frac{(1-\xi)(\lambda_c-1)}{L_t (\lambda_c - 0.21) + U_{CH}} \right) + \frac{\lambda_c}{1 + L_t \lambda_c}}{\Phi \left( \frac{\xi}{1 + L_t \lambda_{ko}} - \frac{1}{1 + L_t \lambda_c} \right) + \frac{1}{1 + L_t \lambda_c}}, \quad (81)$$

$$U_{CH} = 3CH_4 + 5C_2H_6 + 7C_3H_8 + 9C_4H_{10}. \quad (82)$$

In case of supplying pure gaseous fuel to the prechamber, at BDC, which corresponds to zero excess air-fuel ratio of mixture  $\lambda_{ko} = 0$ , the Eq. (81) takes somewhat simpler form:

$$\lambda_{kz} = \frac{\Phi \left( \frac{(1-\xi)(\lambda_c-1)}{L_t (\lambda_c - 0.21) + U_{CH}} - \frac{\lambda_c}{1 + L_t \lambda_c} \right) + \frac{\lambda_c}{1 + L_t \lambda_c}}{\Phi \left( \xi - \frac{1}{1 + L_t \lambda_c} \right) + \frac{1}{1 + L_t \lambda_c}}. \quad (83)$$

### 3. The sensitivity of the excess air-fuel ratio of mixture in the prechamber at the ignition time

The analysis of the sensitivity of the combustible mixture in the prechamber ( $\lambda_{kz}$ ) to changes in the excess air-fuel ratio mixture supplied to the prechamber at BDC ( $\lambda_{ko}$ ), excess air-fuel ratio of cylinder ( $\lambda_c$ ), degree of filling of the prechamber in a rich mixture at BDC ( $\xi$ ) and degree of the mixture condensation during the compression stroke ( $\Phi$ ) are presented in the study. For the prechamber supplied in rich mixture and pure gaseous fuel sensitivity was analyzed.

#### 3.1. The relative sensitivity of excess air-fuel ratio in the prechamber $\lambda_{kz}$ fed a rich combustible mixture.

In this model, the instantaneous excess air-fuel ratio in the prechamber powered by rich mixture ( $\lambda_{kz}$ ) depends on the value of the excess air-fuel ratio of mixture supplied to the prechamber at BDC ( $\lambda_{ko}$ ), excess air-fuel ratio of cylinder ( $\lambda_c$ ), degree of filling of the prechamber in mixture at BDC ( $\xi$ ) and degree of the mixture condensation during the compression stroke ( $\Phi$ ). The relative sensitivity of excess air-fuel ratio in the prechamber at the ignition time, to the change of the excess air-fuel ratio of mixture supplied to the prechamber at BDC, change of the excess air-fuel ratio in the cylinder and change the degree of filling of the prechamber in the BDC, it was presented in the paper as ratio of the relative increase of the analyzed parameter, the relative increase in the independent variable. For function of several variables, the relative sensitivity is expressed as a complex function of the partial derivative with respect to this independent variable which impact sensitivity is studied. The equations describing the absolute values of the sensitivity of excess air-fuel ratio in the prechamber at the ignition time to  $\lambda_c$ ,  $\lambda_{ko}$  and  $\xi$  changes. The results of sensitivity analysis are presented in pictures showing the dependence of the absolute values of sensitivity to the degree of the mixture condensation  $\Phi$ .

After determining the  $\left| \frac{\partial \lambda_{kz}}{\partial \lambda_{ko}} \frac{\lambda_{ko}}{\lambda_{kz}} \right|$  received the relative sensitivity of excess air-fuel ratio in the prechamber at the ignition time ( $\lambda_{kz}$ ) to change the value of excess air-fuel ratio of mixture delivered to the prechamber at BDC by additional fuel system ( $\lambda_{ko}$ ):

$$\left| \frac{\partial \lambda_{kz}}{\partial \lambda_{ko}} \frac{\lambda_{ko}}{\lambda_{kz}} \right| = \left[ \frac{\Phi \left( \frac{\xi}{1 + L_t \lambda_{ko}} - \frac{\xi \lambda_{ko} L_t}{(1 + L_t \lambda_{ko})^2} \right)}{\Phi \left( \frac{\xi}{1 + L_t \lambda_{ko}} - \frac{1}{1 + L_t \lambda_c} \right) + \frac{1}{1 + L_t \lambda_c}} + \frac{\Phi \left( \xi \frac{\lambda_{ko}}{1 + L_t \lambda_{ko}} - \frac{\lambda_c}{1 + L_t \lambda_c} + \frac{(1-\xi)(\lambda_c-1)}{L_t (\lambda_c - 0.21) + U_{CH}} \right) + \frac{\lambda_c}{1 + L_t \lambda_c}}{\left( \Phi \left( \frac{\xi}{1 + L_t \lambda_{ko}} - \frac{1}{1 + L_t \lambda_c} \right) + \frac{1}{1 + L_t \lambda_c} \right)^2} \frac{\Phi \xi L_t}{(1 + L_t \lambda_{ko})^2} \right] \left[ \frac{\lambda_{ko} \Phi \left( \frac{\xi}{1 + L_t \lambda_{ko}} - \frac{1}{1 + L_t \lambda_c} \right) + \frac{\lambda_{ko}}{1 + L_t \lambda_c}}{\Phi \left( \frac{\xi \lambda_{ko}}{1 + L_t \lambda_{ko}} - \frac{\lambda_c}{1 + L_t \lambda_c} + \frac{(1-\xi)(\lambda_c-1)}{L_t (\lambda_c - 0.21) + U_{CH}} \right) + \frac{\lambda_c}{1 + L_t \lambda_c}} \right]. \quad (84)$$

*Theoretical analysis of air-fuel mixture formation in the combustion chambers of the gas engine...*

After determining the  $\left| \frac{\partial \lambda_{kz}}{\partial \lambda_c} \frac{\lambda_c}{\lambda_{kz}} \right|$  received the relative sensitivity of excess air-fuel ratio in the prechamber at the ig-

niton time ( $\lambda_{kz}$ ) to change the value of excess air-fuel ratio of mixture in the cylinder ( $\lambda_c$ ):

$$\left| \frac{\partial \lambda_{kz}}{\partial \lambda_c} \frac{\lambda_c}{\lambda_{kz}} \right| = \left| \left[ \frac{\Phi \left( \frac{-1}{1+L_t \lambda_c} + \frac{\lambda_c L_t}{(1+L_t \lambda_c)^2} + \frac{1-\xi}{L_t(\lambda_c-0.21)+U_{CH}} \right)}{\Phi \left( \frac{\xi}{1+L_t \lambda_{k_o}} - \frac{1}{1+L_t \lambda_c} \right) + \frac{1}{1+L_t \lambda_c}} + \frac{\frac{(1-\xi)(\lambda_c-1)L_t}{(L_t(\lambda_c-0.21)+U_{CH})^2} + \frac{1}{1+L_t \lambda_c} - \frac{\lambda_c L_t}{(1+L_t \lambda_c)^2}}{\Phi \left( \frac{\xi}{1+L_t \lambda_{k_o}} - \frac{1}{1+L_t \lambda_c} \right) + \frac{1}{1+L_t \lambda_c}} \right. \right. \\ \left. \left. + \frac{\Phi \left( \frac{\xi \lambda_{k_o}}{1+L_t \lambda_{k_o}} - \frac{\lambda_c}{1+L_t \lambda_c} + \frac{(1-\xi)(\lambda_c-1)}{L_t(\lambda_c-0.21)+U_{CH}} \right) + \frac{\lambda_c}{1+L_t \lambda_c} \left( \frac{L_t(\Phi-1)}{(1+L_t \lambda_c)^2} \right)}{\left( \Phi \left( \frac{\xi}{1+L_t \lambda_{k_o}} - \frac{1}{1+L_t \lambda_c} \right) + \frac{1}{1+L_t \lambda_c} \right)^2} \left( \frac{L_t(\Phi-1)}{(1+L_t \lambda_c)^2} \right)} \right] \left[ \frac{\Phi \lambda_c \left( \frac{\xi}{1+L_t \lambda_{k_o}} - \frac{1}{1+L_t \lambda_c} \right) + \frac{\lambda_c}{1+L_t \lambda_c}}{\Phi \left( \frac{\xi \lambda_{k_o}}{1+L_t \lambda_{k_o}} - \frac{\lambda_c}{1+L_t \lambda_c} + \frac{(1-\xi)(\lambda_c-1)}{L_t(\lambda_c-0.21)+U_{CH}} \right) + \frac{\lambda_c}{1+L_t \lambda_c}} \right] \right| \quad (85)$$

After determining the  $\left| \frac{\partial \lambda_{kz}}{\partial \xi} \frac{\xi}{\lambda_{kz}} \right|$  received the relative sensitivity of excess air-fuel ratio in the prechamber at the

ignition time ( $\lambda_{kz}$ ) to change the degree of filling of the prechamber in a mixture at BDC ( $\xi$ ):

$$\left| \frac{\partial \lambda_{kz}}{\partial \xi} \frac{\xi}{\lambda_{kz}} \right| = \left| \left[ \frac{\Phi \frac{\frac{\lambda_{k_o}}{1+L_t \lambda_{k_o}} - \frac{(\lambda_c-1)}{L_t(\lambda_c-0.21)+U_{CH}}}{\Phi \left( \frac{\xi}{1+L_t \lambda_{k_o}} - \frac{1}{1+L_t \lambda_c} \right) + \frac{1}{1+L_t \lambda_c}}}{\Phi \left( \frac{\xi \lambda_{k_o}}{1+L_t \lambda_{k_o}} - \frac{\lambda_c}{1+L_t \lambda_c} + \frac{(1-\xi)(\lambda_c-1)}{L_t(\lambda_c-0.21)+U_{CH}} \right) + \frac{\lambda_c}{1+L_t \lambda_c}} \frac{\Phi}{1+L_t \lambda_{k_o}}} \right. \right. \\ \left. \left. \left[ \frac{\xi \Phi \left( \frac{\xi}{1+L_t \lambda_{k_o}} - \frac{1}{1+L_t \lambda_c} \right) + \frac{\xi}{1+L_t \lambda_c}}{\Phi \left( \frac{\xi \lambda_{k_o}}{1+L_t \lambda_{k_o}} - \frac{\lambda_c}{1+L_t \lambda_c} + \frac{(1-\xi)(\lambda_c-1)}{L_t(\lambda_c-0.21)+U_{CH}} \right) + \frac{\lambda_c}{1+L_t \lambda_c}} \right] \right] \right| \quad (86)$$

**3.2. The relative sensitivity of excess air-fuel ratio  $\lambda_{kz}$  in the prechamber powered by pure gaseous fuel.** For a pure gaseous fuel ( $\lambda_{k_o} = 0$ ) equation of  $\left| \frac{\partial \lambda_{kz}}{\partial \lambda_{k_o}} \frac{\lambda_{k_o}}{\lambda_{kz}} \right|$  determine the relative sensitivity of excess air-fuel ratio in the prechamber at the ignition time ( $\lambda_{kz}$ ) to change the value of excess air-fuel ratio of mixture delivered to the prechamber at BDC by addi-

tional fuel system ( $\lambda_{k_o}$ ) is equal to 0. After determining the  $\left| \frac{\partial \lambda_{kz}}{\partial \lambda_c} \frac{\lambda_c}{\lambda_{kz}} \right|$  received the relative sensitivity of excess air-fuel ratio in the prechamber at the ignition time ( $\lambda_{kz}$ ) to change the value of excess air-fuel ratio of mixture in the cylinder ( $\lambda_c$ ):

$$\left| \frac{\partial \lambda_{kz}}{\partial \lambda_c} \frac{\lambda_c}{\lambda_{kz}} \right| = \left| \left[ \frac{\Phi \left( \frac{-1}{1+L_t \lambda_c} + \frac{\lambda_c L_t}{(1+L_t \lambda_c)^2} + \frac{1-\xi}{L_t(\lambda_c-0.21)+U_{CH}} \right)}{\Phi \left( \xi - \frac{1}{1+L_t \lambda_c} \right) + \frac{1}{1+L_t \lambda_c}} + \frac{\frac{(1-\xi)(\lambda_c-1)L_t}{(L_t(\lambda_c-0.21)+U_{CH})^2} + \frac{1}{1+L_t \lambda_c} - \frac{\lambda_c L_t}{(1+L_t \lambda_c)^2}}{\Phi \left( \xi - \frac{1}{1+L_t \lambda_c} \right) + \frac{1}{1+L_t \lambda_c}} \right. \right. \\ \left. \left. - \frac{\Phi \left( \frac{(1-\xi)(\lambda_c-1)}{L_t(\lambda_c-0.21)+U_{CH}} - \frac{\lambda_c}{1+L_t \lambda_c} \right) + \frac{\lambda_c}{1+L_t \lambda_c} \left( \frac{L_t(\Phi-1)}{(1+L_t \lambda_c)^2} \right)}{\left( \Phi \left( \xi - \frac{1}{1+L_t \lambda_c} \right) + \frac{1}{1+L_t \lambda_c} \right)^2} \left( \frac{L_t(\Phi-1)}{(1+L_t \lambda_c)^2} \right)} \right] \left[ \frac{\Phi \lambda_c \left( \xi - \frac{1}{1+L_t \lambda_c} \right) + \frac{\lambda_c}{1+L_t \lambda_c}}{\Phi \left( \frac{(1-\xi)(\lambda_c-1)}{L_t(\lambda_c-0.21)+U_{CH}} - \frac{\lambda_c}{1+L_t \lambda_c} \right) + \frac{\lambda_c}{1+L_t \lambda_c}} \right] \right| \quad (87)$$

After determining the  $\left| \frac{\partial \lambda_{kz}}{\partial \xi} \frac{\xi}{\lambda_{kz}} \right|$  received the relative sensitivity of excess air-fuel ratio in the prechamber at the ignition time ( $\lambda_{kz}$ ) to change the degree of filling of the prechamber in a mixture at BDC ( $\xi$ ):

$$\left| \frac{\partial \lambda_{kz}}{\partial \xi} \frac{\xi}{\lambda_{kz}} \right| = \left| \left[ \frac{\Phi \frac{(\lambda_c - 1)}{L_t(\lambda_c - 0.21) + U_{CH}}}{\Phi \left( \xi - \frac{1}{1 + L_t \lambda_c} \right) + \frac{1}{1 + L_t \lambda_c}} - \frac{\Phi \left( \frac{(1 - \xi)(\lambda_c - 1)}{L_t(\lambda_c - 0.21) + U_{CH}} - \frac{\lambda_c}{1 + L_t \lambda_c} \right) + \frac{\lambda_c}{1 + L_t \lambda_c}}{\left( \Phi \left( \xi - \frac{1}{1 + L_t \lambda_c} \right) + \frac{1}{1 + L_t \lambda_c} \right)^2} \Phi \right] \left[ \frac{\xi \Phi \left( \xi - \frac{1}{1 + L_t \lambda_c} \right) + \frac{\xi}{1 + L_t \lambda_c}}{\Phi \left( \frac{(1 - \xi)(\lambda_c - 1)}{L_t(\lambda_c - 0.21) + U_{CH}} - \frac{\lambda_c}{1 + L_t \lambda_c} \right) + \frac{\lambda_c}{1 + L_t \lambda_c}} \right] \right|. \quad (88)$$

## 4. Calculations

The modeling was performed to determine changes and the sensitivity of excess air-fuel ratio in the prechamber  $\lambda_{kz}$  during the compression stroke, from the BDC to the ignition time.

Calculations were carried out to determine: an impact of changes of excess air-fuel ratio of combustible mixture in the prechamber at initial conditions at beginning of compression stroke ( $\lambda_{ko}$ ), an impact of change of degree of filling of the prechamber in a rich mixture ( $\xi$ ) and an impact of change excess air-fuel ratio of a mixture in the cylinder ( $\lambda_c$ ) on an excess air-fuel ratio of mixture in the prechamber at ignition time ( $\lambda_{kz}$ ). The courses of  $\lambda_{kz}$  as a function of degree of the mixture condensation during the compression stroke  $\Phi$  were determined. The values of geometrical dimensions of the modeled engine were taken from real engine [6]. The calculations was performed for excess air-fuel ratio in the range from 0 to 0.45, degree of filling of the prechamber in a rich mixture from 0.06 to 0.96 and an excess air-fuel ratio in the cylinder from 1.35 to 2.5 (at BDC). Table 1 shows the input parameters of the modelled process.

Table 1  
Input parameters of modelled process

| Quantity   | Dimension                                      | Sign                           | Value                   |
|--|--|--------------------------------|-------------------------|
| bore   | m  | D                              | 0.12                    |
| stroke   | m  | S                              | 0.16                    |
| compression stroke   | –  | $\varepsilon$                  | 8.6                     |
| crank radius to connecting rod length ratio  | –  | $\lambda_w$                    | 0.29                    |
| excess air-fuel ratio of mixture in the cylinder   | –  | $\lambda_c$                    | 1.35–2.5                |
| excess air-fuel ratio of mixture in the prechamber at the beginning of compression stroke at BDC | –  | $\lambda_{ko}$                 | 0–0.45                  |
| degree of filling of the prechamber in a rich mixture  | –  | $\xi$                          | 0.06–0.95               |
| molar fraction of methane in the LPG   | kmol CH <sub>4</sub> /kmol fuel                | CH <sub>4</sub>                | 0.008                   |
| molar fraction of ethane in the LPG  | kmol C <sub>2</sub> H <sub>6</sub> /kmol fuel  | C <sub>2</sub> H <sub>6</sub>  | 0.026                   |
| molar fraction of propane in the LPG   | kmol C <sub>3</sub> H <sub>8</sub> /kmol fuel  | C <sub>3</sub> H <sub>8</sub>  | 0.528                   |
| molar fraction of butane in the LPG  | kmol C <sub>4</sub> H <sub>10</sub> /kmol fuel | C <sub>4</sub> H <sub>10</sub> | 0.438                   |
| stoichiometric air demand (LPG)  | kmol air/kmol fuel                             | $L_t$                          | 26.63                   |
| displacement   | m <sup>3</sup>                                 | $V_s$                          | 1.8095 10 <sup>–3</sup> |
| volume of prechamber   | m <sup>3</sup>                                 | $V_k$                          | 0.0104 10 <sup>–3</sup> |
| volume of combustion chamber in the piston   | m <sup>3</sup>                                 | $V_t$                          | 0.0702 10 <sup>–3</sup> |
| volume of combustion chamber between piston and head surface at TDC                              | m <sup>3</sup>                                 | $V_\delta$                     | 0.1575 10 <sup>–3</sup> |
| total volume of combustion chambers  | m <sup>3</sup>                                 | $V_{ck}$                       | 0.2381 10 <sup>–3</sup> |
| total volume of cylinder at BDC  | m <sup>3</sup>                                 | $V_c$                          | 2.0376 10 <sup>–3</sup> |



## 5. Mathematical analysis of the model

Changes in the excess air-fuel ratio of a mixture in the prechamber as a result of the initial inflow of the lean mixture from cylinder of  $\lambda_c = 2.0$  during the compression stroke, the degree of filling of the prechamber equal to 0.6, for six values of excess air-fuel ratio in the prechamber at the beginning of the compression stroke, the range 0 to 0.3, shown in Fig. 3. It shows that to obtain in the prechamber a mixture of  $\lambda_{kz} \cong 1 \pm 0.05$ , at the time corresponding to the ignition time angle in the range from 0 to 30 deg CA BTDC, it is only possible when the combustible mixture composition at BDC, the excess air-fuel ratio takes the value from 0.085 to 0.21. Exceeding these limits does not allow to obtain a mixture composition close to stoichiometric, for  $\lambda_{ko} < 0.085$  mixture is too rich, and for  $\lambda_{ko} > 0.21$  is too poor.

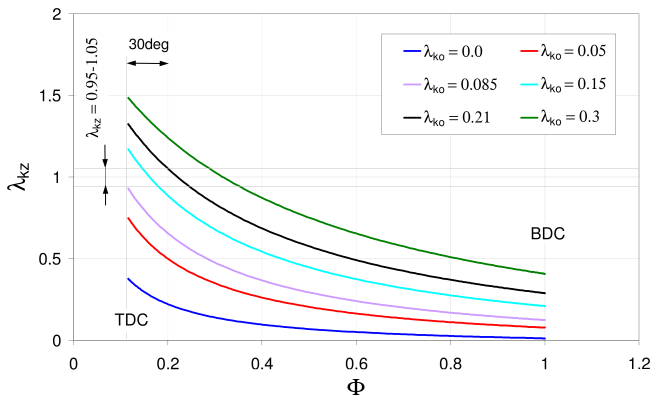

Fig. 3. Excess air-fuel ratio of mixture in prechamber during compression process for different values of excess air-fuel ratio in prechamber at BDC for  $\lambda_c = 2.0$  and  $\xi = 0.6$

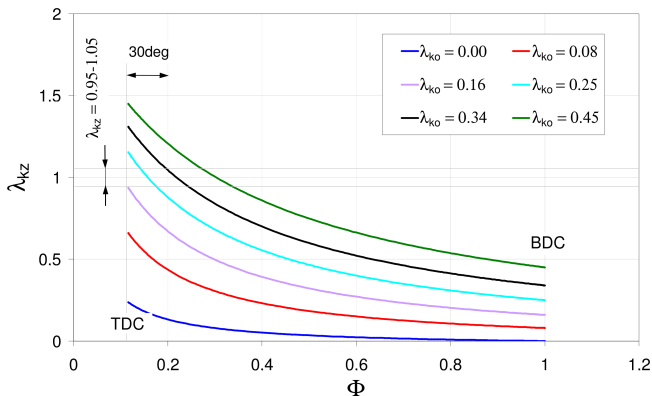

Fig. 4. Excess air-fuel ratio of mixture in prechamber during compression stroke for different mixture composition in prechamber at BDC for  $\lambda_c = 2.0$  and  $\xi = 1.0$

The mixture excess air-fuel ratio in the prechamber as a result of the initial inflow of lean mixture from cylinder of  $\lambda_c = 2.0$  during the compression stroke, for the prechamber completely filled with a rich mixture ( $\xi = 1.0$ ), for six values of excess air-fuel ratio in the prechamber at the beginning of the compression stroke, in the range from 0 to 0.45, is shown in Fig. 4. It shows that to obtain a mixture of  $\lambda_{kz} \cong 1 \pm 0.05$

in the prechamber, at the range of ignition time from 0 to 30 deg CA BTDC, it is only possible if the mixture composition at BDC will correspond to the excess air-fuel ratio from 1.16 to 0.34. Exceeding these limits does not allow obtaining a mixture composition close to stoichiometric, for  $\lambda_{ko} < 0.16$  mixture is too rich, and for  $\lambda_{ko} > 0.34$  is too poor.

The mixture excess air-fuel ratio in the prechamber as a result of the initial inflow of lean mixture from cylinder of  $\lambda_c = 2.0$  during the compression stroke, for the degree of filling of the prechamber equal to 0.12, for six values of excess air-fuel ratio in the prechamber at the beginning of the compression stroke, in the range from 0 to 0.05, is shown in Fig. 5. It shows that to obtain a mixture of  $\lambda_{kz} \cong 1 \pm 0.05$  in the prechamber, at the range of ignition time from 0 to 30 deg CA BTDC, it is only possible if the mixture composition at BDC corresponds to the excess air-fuel ratio from 0 (pure fuel) to 0.02. Exceeding these limits results in depletion of the mixture not allow obtaining a mixture composition close to stoichiometric.

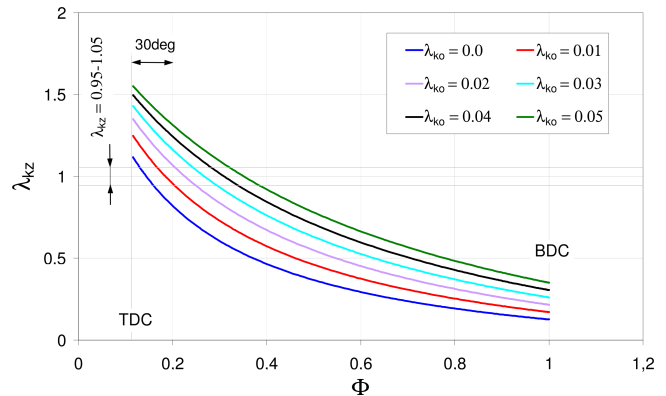

Fig. 5. Excess air-fuel ratio of mixture in prechamber during compression stroke for different mixture composition in prechamber at BDC for  $\lambda_c = 2.0$  and  $\xi = 0.12$

The mixture excess air-fuel ratio in the prechamber of  $\lambda_{ko} = 0.15$  as a result of the initial inflow of lean mixture from cylinder during the compression stroke, for the degree of filling of the prechamber equal to 0.6, for four values of excess air-fuel ratio in the cylinder at beginning of the compression stroke, in the range from 1.35 to 2.5, is shown in Fig. 6. It shows that to obtain a mixture of  $\lambda_{kz} \cong 1 \pm 0.05$  in the prechamber, at the range of ignition time from 0 to 30 deg CA BTDC, it is possible for the whole analyzed range of mixture composition.

The mixture excess air-fuel ratio in the prechamber as a result of the initial inflow of lean mixture from cylinder during the compression stroke, in case when at BDC the prechamber was filled by pure fuel of  $\lambda_{ko} = 0$  and the fuel takes 12% of the prechamber volume ( $\xi = 0.12$ ), for four values of excess air-fuel ratio in the cylinder in the range from 1.45 to 2.5, is shown in Fig. 7.

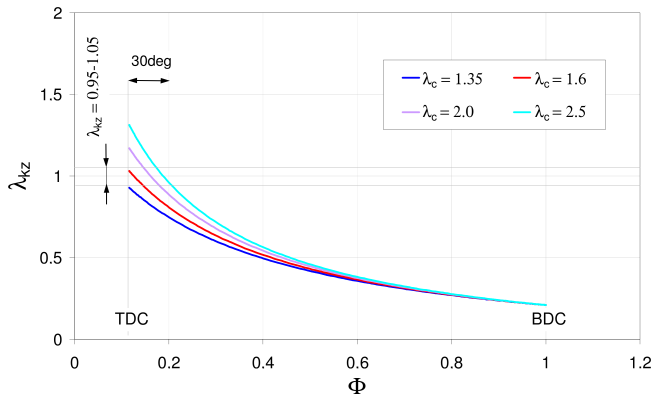

Fig. 6. Excess air-fuel ratio of mixture in prechamber during compression process for different values of excess air-fuel ratio in cylinder, (prechamber powered by rich mixture of  $\lambda_{k_{co}} = 0.15$  for  $\xi = 0.6$ )

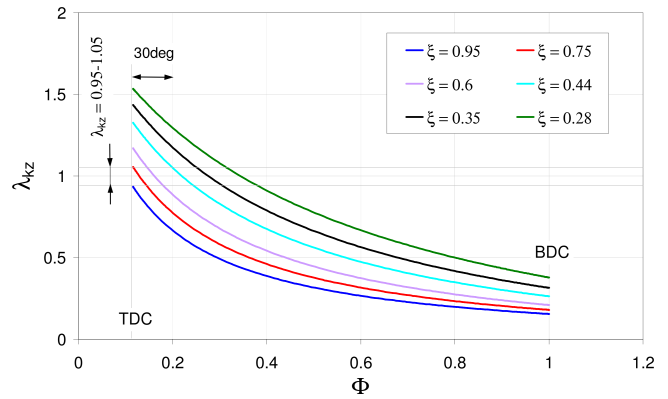

Fig. 8. Excess air-fuel ratio of mixture in prechamber during compression process for different values of degree of filling of prechamber at BDC, (prechamber powered by rich mixture of  $\lambda_{k_{co}} = 0.15$  for  $\lambda_c = 2.0$ )

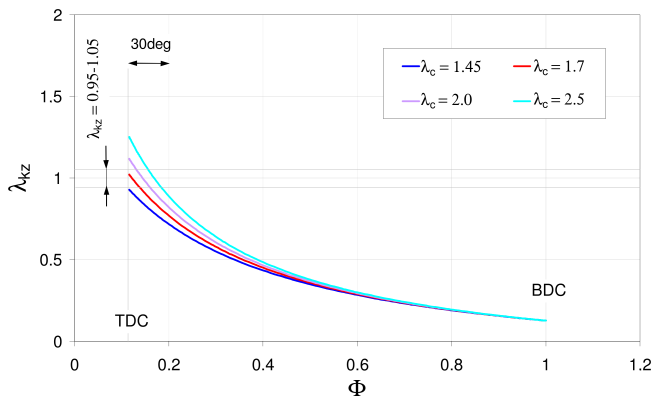

Fig. 7. Excess air-fuel ratio of mixture in prechamber during compression process for different values of excess air-fuel ratio in cylinder, (prechamber powered by pure fuel of  $\lambda_{k_{co}} = 0$  for  $\xi = 0.12$ )

It shows that in the case where the prechamber is filled in 12% of pure fuel that to obtain a mixture of  $\lambda_{kz} \cong 1 \pm 0.05$  in the prechamber, at the range of ignition time from 0 to 30 deg CA BTDC, it is possible for the whole analyzed range of mixture composition.

Figure 8 shows the courses of excess air-fuel ratio of rich mixture in the prechamber as a result of the inflow of lean mixture of  $\lambda_c = 2.0$  from cylinder during the compression stroke, from value of  $\lambda_{k_{co}} = 0.15$  at BDC, for six values of degree of filling of the prechamber in the range of 0.28 to 0.95. It shows that to obtain stoichiometric mixture in the prechamber for ignition time in the range of 0 to 30 deg BTDC, it is only possible if at BDC the rich mixture of  $\lambda_{k_{co}} = 0.15$  in the prechamber will take from 44% to 95% its volume, which is equal to the degree of filling of 0.44 to 0.95. Filling of the prechamber with mixture below 44% will lead to the depletion of lean mixture from the cylinder above  $\lambda_{kz} \cong 1 \pm 0.05$ , and filling more than 95% will produce a mixture too rich, below  $\lambda_{kz} \cong 1 \pm 0.05$ .

Figure 9 shows the course of dilution of mixture in the prechamber by lean mixture of  $\lambda_c = 2.0$  from cylinder, during compression stroke, from value of  $\lambda_{k_{co}} = 0$  at BDC, for six values of degree of filling of the prechamber in the range of 0.06 to 0.3. The chart shows that a poor combustible mixture, delivered into the prechamber during the compression stroke is not able to deplete the pure fuel to stoichiometric mixture at the moment of ignition if it takes more than 17% or less than 8% of volume of prechamber at BDC.

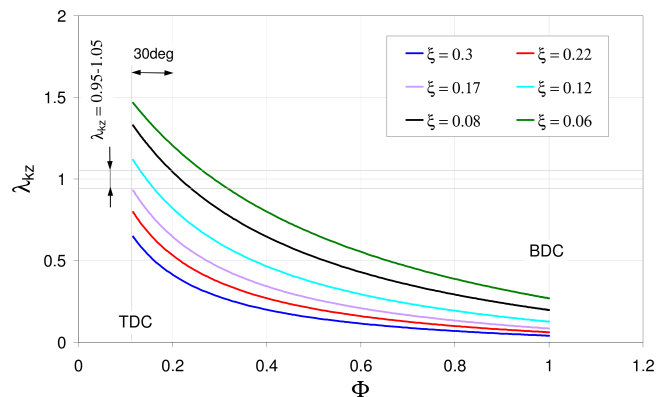

Fig. 9. Excess air-fuel ratio of mixture in prechamber during compression process for different values of degree of filling of prechamber at BDC, (prechamber powered by pure fuel of  $\lambda_{k_{co}} = 0$  for  $\lambda_c = 2.0$ )

Comparison of the relative sensitivity of an excess air-fuel ratio in the prechamber at the ignition time, on the change of the excess air-fuel ratio of mixture in the prechamber at BDC of  $\lambda_{k_{co}} = 0.15$ , changes of excess air-fuel ratio of mixture in the cylinder of  $\lambda_c = 2.0$  and changes of degree of filling of the prechamber at BDC of  $\xi = 0.6$ , are shown in Fig. 10. The presented case relates to conditions, in which, compressed lean mixture from cylinder of  $\lambda_c = 2.0$  diluted rich mixture of  $\lambda_{k_{co}} = 0.15$  which takes 60% of the volume of the prechamber ( $\xi = 0.6$ ).

*Theoretical analysis of air-fuel mixture formation in the combustion chambers of the gas engine...*

Fig. 10. Relative  $\lambda_{kz}$  sensitivity to mixture of excess air ratio change in prechamber at BDC ( $\lambda_{ko}$ ) determined by the Eq. (27), excess air ratio in cylinder ( $\lambda_c$ ) determined by the Eq. (28), and degree of filling of prechamber at BDC ( $\xi$ ) determined by the Eq. (29) in function of degree of the mixture condensation, (prechamber powered by rich mixture of  $\lambda_{ko} = 0.15$  for  $\lambda_c = 2.0$  and  $\xi = 0.6$ )

On the basis of the presented characteristics of the sensitivity can be state that in case the prechamber is supplied with a rich mixture of  $\lambda_{ko} = 0.15$  at BDC of piston, the value of excess air-fuel ratio of the prechamber at time corresponding to range angle of ignition advance from 0 to 30 deg CA BTDC ( $\lambda_{kz}$ ), it is similarly dependent on changes the degree of filling with the rich mixture at BDC ( $\xi$ ) and value of excess air-fuel ratio of mixture supplied to the prechamber at BDC ( $\lambda_{ko}$ ). The calculated sensitivity of  $\lambda_{kz}$  at TDC was equal to: sensitivity to changes  $\xi - 0.41$ , to changes  $\lambda_{ko} - 0.37$ . Impact of excess air-fuel ratio in the cylinder ( $\lambda_c$ ) to changes of  $\lambda_{kz}$  was significantly lower and it reaches value of  $-0.19$ .

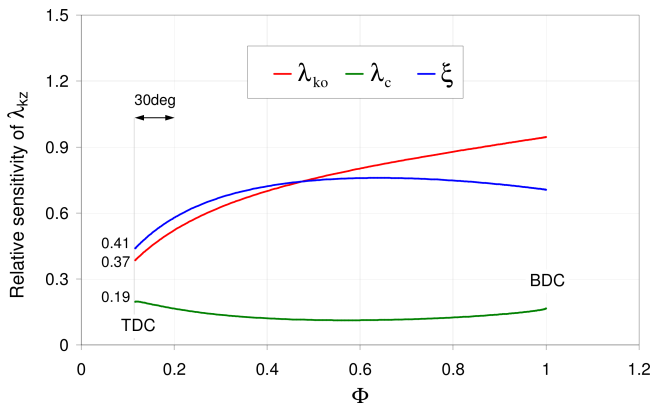
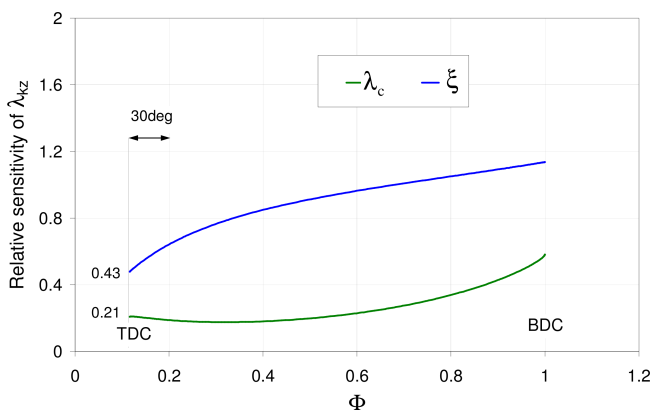

Fig. 11. Relative sensitivity of  $\lambda_{kz}$  to excess air ratio changes of mixture in the cylinder ( $\lambda_c$ ) determined by the Eq. (30) and degree of filling of prechamber at BDC ( $\xi$ ) determined by the Eq. (31) as a function of degree of condensation fuel mixture (chamber supplied with pure fuel of  $\lambda_{ko} = 0$  at  $\lambda_c = 2.0$  and  $\xi = 0.12$ )

Comparison of the relative sensitivity of excess air-fuel ratio in the prechamber at the ignition time, on the change of the excess air mixture in the cylinder of  $\lambda_c = 2.0$ , and changes of degree of filling of the prechamber at BDC of  $\xi = 0.12$  are shown in Fig. 11. Presented case relates to conditions, in which, compressed lean mixture from cylinder of  $\lambda_c = 2.0$

diluted rich mixture of pure fuel of  $\lambda_{ko} = 0$  which takes 12% of the volume of the prechamber ( $\xi = 0.12$ ).

On the basis of the presented characteristics of the sensitivity can be state that in case the prechamber is supplied with gas fuel, the value of excess air-fuel ratio of the prechamber at time corresponding to range angle of ignition advance from 0 to 30 deg CA BTDC ( $\lambda_{kz}$ ), it is dependent on the degree of filling with the fuel at BDC ( $\xi$ ). Calculated sensitivity of  $\lambda_{kz}$  to changes in  $\xi$  at TDC piston was equal  $-0.43$  and it was more than two times larger than the sensitivity to changes in the value of the excess air-fuel ratio in the cylinder ( $\lambda_c$ )  $-0.21$ .

## 6. Summary

On the basis of the performed analysis of sensitivity of the air fuel mixture composition in the prechamber of the engine with two stage combustion system shows that in the test gas engine, the value of excess air-fuel ratio of prechamber at the moment of ignition ( $\lambda_{kz}$ ) similarly depend on changes the degree of filling with the rich mixture at BDC ( $\xi$ ) and value of excess air-fuel ratio of mixture supplied to the prechamber at BDC ( $\lambda_{ko}$ ). The impact of changes in the value of an excess air-fuel ratio of a mixture in the cylinder ( $\lambda_c$ ) is more than twice smaller. This means that the engine with the two-stage combustion system during operation requires particularly accurate and precise determination maintaining a constant quantity and composition of the air-fuel mixture supplied to the pre-chamber. In the modern stationary gas engines operating with a two-stage combustion system, enriching fuel mixture in the pre-chamber is usually as a result of the supply of gas by additional supply system. The composition of the combustible mixture in the prechamber of such engine is changing during compression stroke and it depends inter alia on the mixture composition in the cylinder of engine ( $\lambda_c$ ) and degree of filling of prechamber by gas fuel ( $\xi$ ). On the basis of model analysis of process of air-fuel mixture creation can be stated that in case the prechamber is supplied with gas fuel (at BDC), the value of excess air-fuel ratio of the prechamber at time of ignition is the most sensitive to changes of filling degree of the chamber in fuel at TDC ( $\xi$ ) namely value of fuel dose delivered to the prechamber. The impact of changes in the value of excess air-fuel ratio of mixture supplied to the cylinder is more than twice smaller. The very important control parameter in case supply the prechamber in rich air-fuel mixture or in pure gas fuel is the degree of filling the prechamber in fresh charge. In both cases, the precise determination of the dose of fresh charge is very important and should be of particular concern. For engine with prechamber supplied in rich mixture in addition the very important is to product of the mixture with very strict composition. The presented results of mathematical analysis of preparation process of combustible mixture in the prechamber was successfully used during experimental researches of engine with two stage combustion system which was realize in the Institute of Thermal Machinery [24]. The results of the analysis were also confirmed by CFD modeling test engine [25]. On

the basis of presented results the precise supply system of gas fuel and gas mass consumption measurement system was build [26].

REFERENCES

[1] M. Bernhardt, J. Michałowska, and S. Radzimirski, "Automotive air pollution", WKŁ, Warsaw, 1976.

[2] K. Cupiał, A. Jamrozik, and A. Kociszewski, "Vergleich von Gasmotoren, die mit verschiedenen Verbrennungssystemen arbeiten", *Erste Internationale Fachthemenkonferenz Gasmotoren, MOTORTECH GmbH 1*, CD-ROM (2003).

[3] M. Kekez and L. Radziszewski, "Genetic-fuzzy model of diesel engine working cycle", *Bull. Pol. Ac.: Tech.* 58 (4), 665–671 (2010).

[4] J.B. Heywood, *Internal Combustion Engine Fundamentals*, McGraw-Hill, London, 1988.

[5] A. Kowalewicz, S. Luft, A. Różycki, and M. Gola, "Chosen aspects of feeding in SI engines with poor gasoline-air mixtures", *J. Kones, Internal Combustion Engines* 6, 156–162 (1999).

[6] A. Jamrozik, "Creation and combustion of heterogeneous burn mixtures in spark ignition engines", *PhD Thesis*, Czestochowa University of Technology, Czestochowa, 2004.

[7] L.A. Gussak, G.V. Ewart, and D.A. Ribiński, "Carburetor type internal combustion engine with prechamber", *U.S.Patent*, 3.092.088, 1963.

[8] L.A. Gussak, "Method of prechamber torch ignition in internal combustion engines", *U.S.Patent*, 3.230.939, 1966.

[9] A.K. Oppenheim, K. Teichman, K. Hom, and H.E. Stewart, "Jet ignition of an ultra-lean mixture", *SAE Paper* 87, 2416–2428 (1978).

[10] A.K. Oppenheim, H.E. Stewart, and K. Hom, "Pulsed jet combustion generator for premixed charge engines", *U.S.Patent*, 4.926.818, 1990.

[11] A. Kowalewicz, *Combustion Systems of the High Speed Internal Combustion Engines*, WKŁ, Warsaw, 1980.

[12] C.C.J. French, "Alternative engines – interest or a real alternative", *Auto – Automotive Technology* 10, 4–9 (1990).

[13] M. Noguchi, S. Sanda, and N. Nakamura, "Development of Toyota lean burn engine", *SAE Paper* 760757, 2358–2373 (1976).

[14] *Emission Standards – European Union. Heavy-Duty Diesel Truck and Bus Engines*, Dieselnets, available at <http://www.dieselnets.com/standards>. (September 2009).

[15] B. Sendyka and M. Cygnar, "Stratified charge combustion in a spark ignition engine with direct injection system", in *Advances in Internal Combustion Engines and Fuel Technologies*, ed. Hoon Kiat Ng, ISBN 978-953-51-1048-4, Rijeka, 2013.

[16] B. Sendyka and M. Noga, "Combustion process in the spark-ignition engine with dual-injection system", in *Advances in Internal Combustion Engines and Fuel Technologies*, ed. Hoon Kiat Ng, ISBN 978-953-51-1048-4, Rijeka, 2013.

[17] G. Budzik, M. Cygnar, L. Marciniak-Podsadna, M. Grzelka, B. Sendyka, and A. Stoic, "Numerical analysis of the engine with spark ignition and compression ignition", *Technical Gazette* 21 (2), ISSN 1330-3651, pp. 417–423 (2014).

[18] *Worldwide Catalog, 68<sup>th</sup> Annual Product & Buyer's Guide For Engine Power Markets, Diesel & Gas Turbine*, 2003.

[19] P. Janicki, "Production and development of gas engines in the H. Cegielski – FSA", *V Int. Scientific Conf. GAS ENGINES 2000* 1, 179–193 (2000).

[20] T. Stenhede, "Combined Heat and power solutions of Wärtsilä", *Gas Engines* 1, 645–656 (2003).

[21] M.P. Jeffery, "Design and development of the Waukesha AT25GL series gas engine", *Energy Sources Technology Conference and Exhibition* 1, 1–18 (1988).

[22] D. Mooser, "CAT Gas Engines, KEC Kiel Engine Center, CATERPILLAR medium speed gasmotor", *Entwicklung & Betriebserfahrung, Erste Internationale Fachthemenkonferenz Gasmotoren, MOTORTECH GmbH 1*, CD-ROM (2003).

[23] J. Grzelka, "Explosion analysis in the crankcase and manifold gas engine", *PhD Thesis*, Czestochowa University of Technology, Czestochowa, 1990.

[24] A. Jamrozik and W. Tutak, "A study of performance and emissions of SI engine with two-stage combustion system", *Chemical and Process Engineering* 32, 453–471 (2011).

[25] A. Jamrozik A., W. Tutak, A. Kociszewski, and M. Sosnowski, "Numerical simulation of two-stage combustion in SI engine with prechamber", *Applied Mathematical Modelling* 37, 2961–2982 (2013).

[26] S. Szwaja, A. Jamrozik, and W. Tutak, "A two-stage combustion system for burning lean gasoline mixtures in a stationary spark ignited engine", *Applied Energy* 105, 271–281 (2013).