

Impact of phase shifting transformers on cross-border power flows in the Central and Eastern Europe region

R. KORAB and R. OWCZAREK*

Institute of Power System and Control, Silesian University of Technology, 2 Krzywoustego St., 44-100 Gliwice, Poland

Abstract. Unscheduled power flows are a serious problem for the Central and Eastern Europe (CEE) region. One method of reducing these undesirable flows relies on the use of phase shifting transformers (PSTs). This paper presents how the installation of PSTs on the Polish-German and Czech-German borders affects cross-border power flows in the CEE region, as well as interactions between these devices. The essential parameters proposed for PSTs are based on the effects arising from the application of PSTs on the border between Poland and Germany. The results demonstrate that the use of PSTs in the CEE region can provide effective control of active power flows in tie-lines and significantly reduce unscheduled flows. However, the operation of these devices must be coordinated in order to achieve maximum controllability and to guarantee the secure operation of the interconnected systems.

Key words: phase shifting transformers, power flow control, cross-border power flows, unscheduled flows, tie-lines.

1. Introduction

In recent years the Central and Eastern Europe (CEE) region has seen a strong increase in unscheduled compensatory power flows, also known as loop flows, between the transmission systems of the respective countries. Cross-border energy trading within the CEE region, and the ever-increasing number of variable energy sources (mostly wind) in Germany, combined with the insufficient intra-Germany transmission capacity, form the main factors that contribute to the escalation of this phenomenon. These unscheduled flows can block a significant part of the physical transmission capacities on the interconnectors in the CEE region, in particular those related to the tie-lines of the Polish and Czech power systems due to their geographical position. While this limits the amount of available transmission capacity for market participants interested in cross-border energy trading, a much more serious consequence is that, due to their nature, unscheduled flows can lead to acutely critical operational situations and form a threat to the secure operation of the CEE transmission systems [1, 2].

Intersystem power flows increase the load on individual network elements, in particular those lines located in areas close to the borders. Therefore, in order to guarantee the safe operation of the interconnected power system, it is necessary to maintain the cross-border flows below certain limit values. Currently, ensuring the safe operation of the interconnected systems requires power flows from the German to the Polish system to be maintained at a level below 1300 MW in summer and 1600 MW in winter.

In relation to this situation, the transmission system operators (TSOs) in the CEE region take appropriate remedial measures to reduce the negative impact of unscheduled flows. These include re-dispatching power stations (i.e. increasing

generation in one location balanced by decreasing generation in another), power transmission from Germany to Poland via Denmark and Sweden with the use of the Poland-Sweden and Denmark-Germany DC connections (known as the “DC Loop”), and changing the network topology of the national transmission systems [1, 3]. The greatest opportunities, at the risk of incurring additional costs, lie with cross-border redispatching. For example, increasing generation in the Polish system by 1000 MW while decreasing generation in the German system by the same amount reduces the flow of power from the German system to the Polish system by about 500 MW. However, despite the increasingly frequent use of these remedial actions, there are situations in which these measures are insufficient to maintain the safe operation of the system [1, 3, 4], meaning that successful counteraction of the threats requires the use of other unscheduled power flow reduction methods. These include control of the active power flows with phase shifting transformers (PSTs), which are special transformers where the voltage phase angle between input and output can be altered to manage the active power flow along the transmission line. These transformers are also known as phase shifters.

Transformers with quadrature voltage regulation and mechanical tap changers, or FACTS (Flexible AC Transmission System) devices such as TCPAR (Thyristor Controlled Phase Angle Regulator), can be used as phase shifters [5]. Having these devices installed in a transmission network can positively influence the parameters of power system operation in the steady-state, which improves both the system loadability and voltage profile, as well as reduce transmission losses and system generation dispatch costs [6]. Due to the high speed of thyristor control, TCPAR devices can also be helpful in the transient state, enhancing power system stability by damping power swings and frequency oscillations [7–9]. It should be

*e-mail: robert.owczarek@polsl.pl

also added that phase shifters can influence the operation of distance protections [10].

The Polish and German TSOs are planning to install four sets of PSTs on the common border, one in each circuit line, with two sets in the Mikulowa (PL) – Hagenverder (DE) double-circuit line and another other two sets in the Krajinik (PL) – Vierraden (DE) double-circuit line, once the latter is switched to 400 kV (Fig. 1). Furthermore, the Czech TSO is planning to install two PSTs in the Hradec substation, on the border with the German TSO in the Hradec (CZ) – Rohrsdorf (DE) double-circuit line [11].

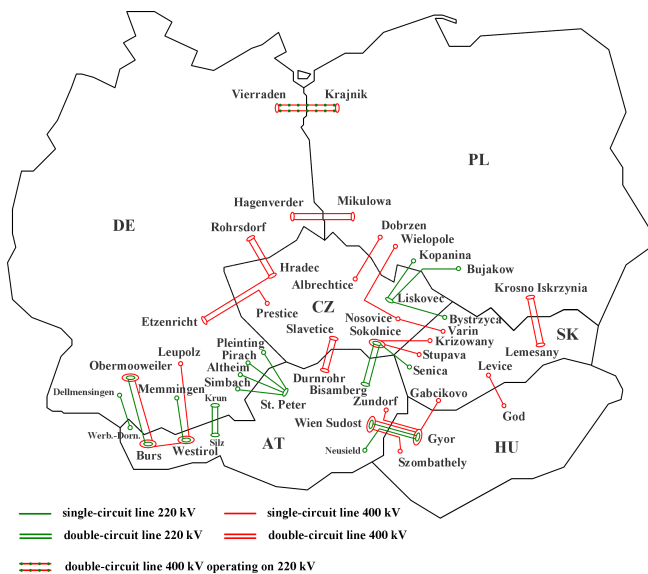

Fig. 1. Main tie-lines in the CEE region – current status

The main purpose of this study was to determine the impact of the installation of these PSTs on cross-border power flows in the CEE region, including the potential capability to reduce unscheduled flows. Additionally, based on these results, the basic parameters were proposed for the PSTs located on the border between Poland and Germany.

2. Power flow control using PSTs

The active power flow through the transmission line is given by the following equation [7]:

$$P_1 = \frac{V_1 \cdot V_2}{X_L} \cdot \sin \delta, \quad (1)$$

where V_1 and V_2 are the voltage modules at the sending and receiving ends of the line, respectively, δ is the power angle (the phase angle difference between \underline{V}_1 and \underline{V}_2), and X_L is the line reactance.

Equation (1) shows that the active power flow through the line can be controlled by changing voltage levels V_1 and V_2 , reactance X_L and power angle δ . However, the full extent of active power flow in the line can be changed by adjusting power angle δ . By controlling angle δ , not only the value of the power flow but also the direction of flow can be changed [12]. In practice this can be done by using PSTs.

A PST connected in series in a transmission line (Fig. 2a) introduces to voltage \underline{V}_1 at the beginning of the line a booster voltage $\Delta \underline{V}$, perpendicular to it. As a result, the resultant voltage \underline{V}_3 behind the PST is shifted in phase by angle α , whereas the power angle of the line is equal to $(\delta + \alpha)$ (Fig. 2b). In this case, the formula describing the active power flow takes the following form [13]:

$$P_2 = \frac{V_3 \cdot V_2}{X_L + X_{PST}} \cdot \sin (\delta + \alpha), \quad (2)$$

where X_{PST} is the PST reactance, α is the PST angle (the phase angle difference between the PST terminal voltages).

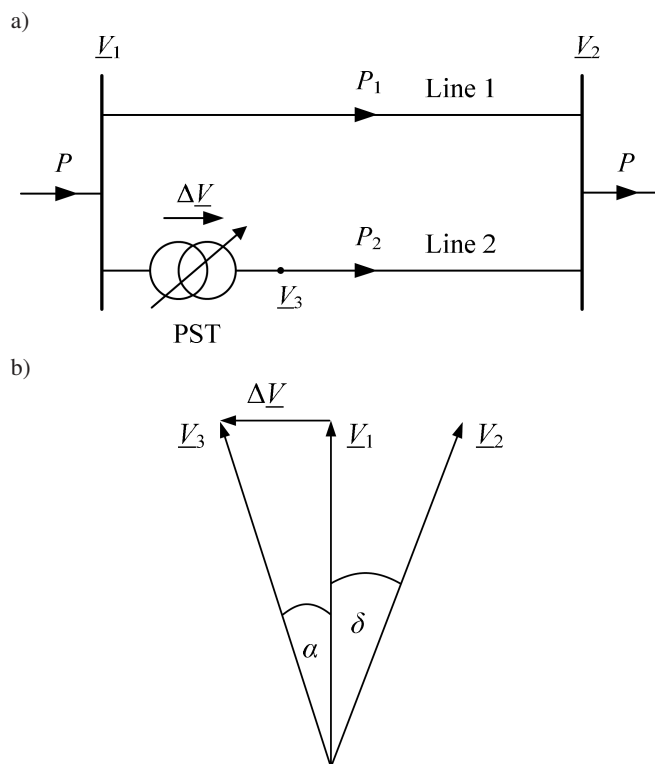

Fig. 2. Controlling the active power flow using a PST: a) circuit diagram, b) phasor diagram for a line with a PST

A change in the booster voltage $\Delta \underline{V}$ causes a change in the angle α and therefore also a change in the line flow P_2 . The voltage $\Delta \underline{V}$ can be controlled within a range from negative values to positive values, resulting in an increase or decrease in the power angle, respectively, and thus the power P_2 .

PSTs are usually used for management of cross-border power flows in interconnected power systems or for power flow control in parallel transmission corridors [7]. These devices have either been implemented or at least seriously considered by several countries [14–20].

3. Subject and method of research

Studies were performed using PLANS distribution software. The analysis included power flow calculations based on models of the interconnected power system in CEE, developed for the year 2014, involving the Polish 400/220/110 kV networks and the transmission networks of the neighbouring countries,

Impact of phase shifting transformers on cross-border power flows in the Central and Eastern Europe region

for two characteristic load states, i.e. summer peak demand (SPD) and winter peak demand (WPD). PST was modelled by an ideal transformer (leakage impedance equal to zero) with a complex turns ratio [21].

The installation of PSTs was considered in all circuits of the 400 kV tie-lines: Hrade-Rohrsdorf (HRD-ROE) on the Czech-German border as well as Mikulowa-Hagenverder (MIK-HAG) and Krajnik-Vierraden (KRA-VIE) on the Polish-German border. At present, the Krajnik-Vierraden tie-line operates at 220 kV (line built to 400 kV parameters); however, it will be modified to utilise 400 kV, the value assumed in the model.

The power flow calculations were divided into three steps. The first step included the control of the PSTs installed on the border between Poland and Germany. The second included the border between the Czech Republic and Germany. The third and last step was carried out for both profiles simultaneously. Control of PSTs was performed both in parallel (i.e. the phase angle of all PSTs was changed simultaneously by the same value and in the same direction) and opposition (i.e. the phase angle of PSTs on both cross-border profiles was changed simultaneously by the same value, but in opposite directions), over the phase angle range of $\pm 45^\circ$, in 5° steps. The total angle range assumed for the analysis resulted from computing capabilities, because beyond 45° the power flow generally did not converge. However, it should be noted that the PSTs currently used in European transmission grids do not exceed an angle adjustment range of $\pm 40^\circ$.

4. Results and analysis

The results are divided into the following subsections. In the figures for the Polish and Czech interconnectors, the positive values indicate an active power that flows in while the negative values indicate an active power that flows out respectively from the Polish and Czech power systems.

4.1. PSTs on the Polish-German border. Figure 3 shows the effect of the joint operation of four PSTs installed on the Polish-German border. It can be seen that the characteristic of the power flow through the cross-border line with respect to the PST angle is quasi-linear. The results revealed that the reduction of active power flowing from the German system into the Polish system occurred at the negative values of the PST angle. Depending on the operating status of the interconnected system, controllable power flows in the Poland-Germany profile are contained within the range 27 to 29 MW/1°. There were observed larger changes in power flows for the Mikulowa-Hagenverder line (15–17 MW/1°) than for the Krajnik-Vierraden line (about 12 MW/1°). This is due to a greater power grid density near the Mikulowa substation (smaller equivalent reactance) in relation to the density of the power grid in the northern area of Poland. It was found that the control of power flows through the cross-border interconnections in the Poland-Germany profile also had an impact on the power flow through the interconnections to other cross-border profiles of the analysed CEE grid

(Fig. 4). The largest changes were observed on the Polish-Czech border (about 21 MW/1°) and the Czech-German profile (about 19 MW/1°). The Polish system interchange balance was virtually constant (small changes in the balance were due to changes in power losses in the 400/220/110 kV power grid).

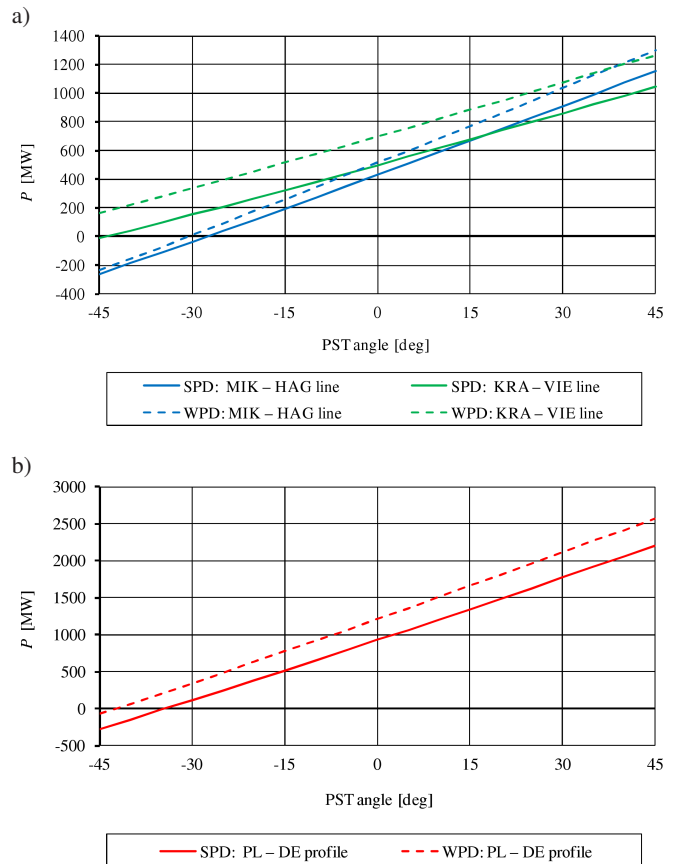

Fig. 3. Impact of parallel control using PSTs installed in the Mikulowa-Hagenverder and Krajnik-Vierraden tie-lines on active power flows

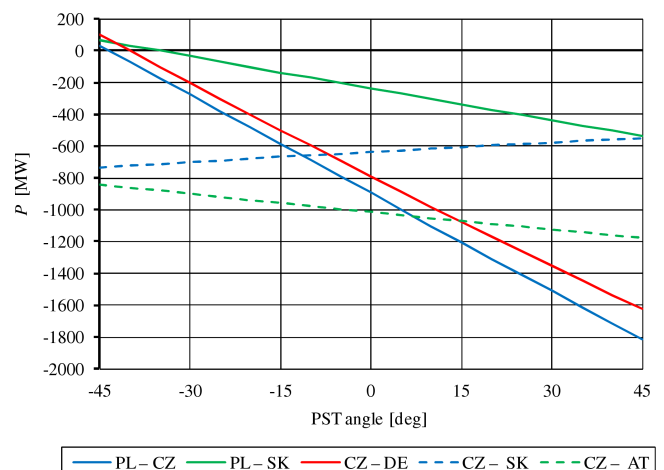

Fig. 4. Impact of parallel control using PSTs installed in the Mikulowa-Hagenverder and Krajnik-Vierraden tie-lines on active power flows through the individual cross-border profiles in the summer season

In the analysed operating conditions of the interconnected system, a number of overloads were observed at zero PST angle, mainly in the 110 kV network. In general, more overloads were observed in the model that mapped the summer peak than for the winter (17 vs. 5 overloads in the 110 kV network). The reason for this is mainly the lower current-carrying capacity of overhead lines in summer conditions. In the model for the summer season, the use of the PSTs to control the flow of active power influences both the increase in the number of overloads in the 110 kV network and the occurrence of overloading of some lines in the EHV grid (Fig. 5), mainly in the areas located close to the border (conditioned by an increase in power flowing through the cross-border interchange lines). For the Polish system, these involved the areas near the Mikulowa and Krajnik substations, and were particularly evident for angles in the 35–45° range. A transformer in the 400/220 kV Hradec substation, for which current overloads already occur at an angle of –20°, was a critical element in the analysed CEE area network. This means that obtaining the required control of the PSTs on the Poland-Germany profile will require appropriate modernisation of the components being at risk of overload.

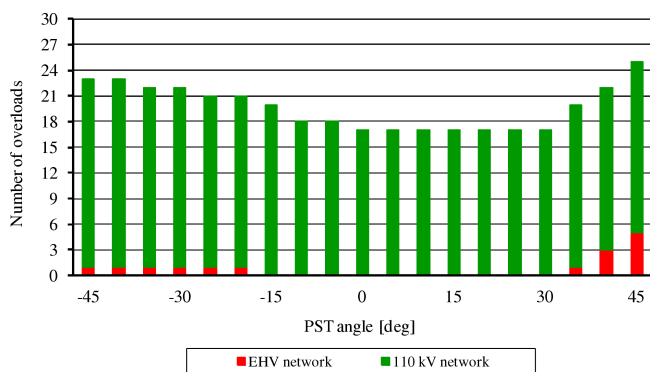

Fig. 5. Impact of parallel control using PSTs installed in the Mikulowa-Hagenverder and Krajnik-Vierraden tie-lines on the number of overloads of network elements in the summer peak demand

The findings also showed that a reduction in active power flowing from the German system into the Polish system can reduce the transmission losses generated in the meshed Polish power system network. For the winter season, a reduction of losses in the 0° to –45° angle range (maximum at –25°, amounting to 2.8%) was achieved (Fig. 6a), while for the summer season, in the 0° to –15° angle range (maximum at –10°, amounting to 0.4%) (Fig. 6b). Nevertheless, reduction the power flow on the Poland-Germany border contributed to the growth of active power losses in neighbouring systems, and the entire analysed network of the CEE region.

The results of the power flow analysis allowed the determination of the first PST parameter, which is the desired angle variation range α . In the existing circumstances, with a large equivalent reactance, to obtain a significant reduction in active power flowing from the German system into the Polish system, the use of PSTs with a suitably wide range of angle adjustment α of about $\pm 40^\circ$ is required.

Due to the interworking of the PSTs with the cross-border lines, the rated (throughput) power of the PSTs needs to be correlated with the load-carrying capacity of the line. Currently, the Polish power system has two interconnections with the German system, and both are designed as double-circuit overhead lines. The load-carrying capacity of one circuit of the Mikulowa-Hagenverder line for low ambient temperatures is 1386 MVA, while that of the Krajnik-Vierraden line circuit is less because it currently operates at 220 kV. The latter will be upgraded to 400 kV, which will result in an increase in its load-carrying capacity to at least the same level as that for the Mikulowa-Hagenverder line. Because of the line capacity and the ability to control PSTs in the Poland-Germany profile, PSTs with throughput power levels of at least 750–1000 MVA are recommended [12].

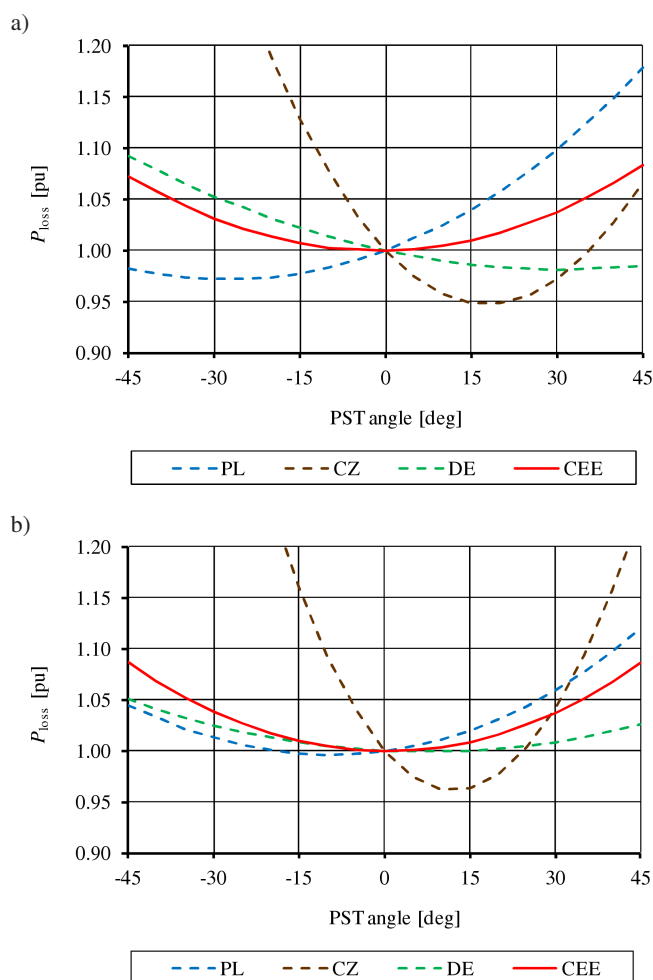

Fig. 6. Impact of parallel control using PSTs installed in the Mikulowa-Hagenverder and Krajnik-Vierraden tie-lines on the active power losses, normalised to a zero PST angle: a) in the winter peak demand, and b) in the summer peak demand

Figure 7 shows a schematic diagram of a possible connection layout of PSTs with both single exchange line circuits (L1, L2). The layout is in the form of a quadrilateral, where a failure of one element results in taking over the load by the remaining ones in an uninterruptible mode. Thus, the total

throughput power of both PSTs (2×750 MVA) allows using of the full capacity of the single-circuit (1386 MVA).

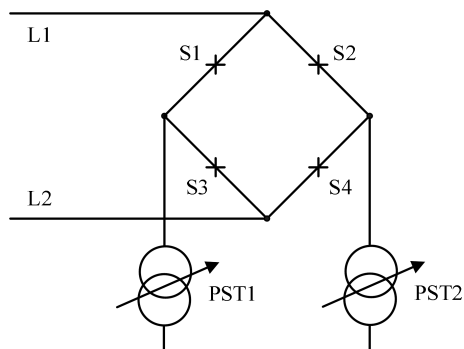

Fig. 7. Schematic diagram of a possible connection layout of PSTs with both single exchange line circuits (L1, L2)

4.2. PSTs on the Czech-German border. The results shown in Fig. 8 demonstrate that control of the PSTs installed in the Hradec-Rohrdsdorf double-circuit line causes the opposite results for changes in the active power flows compared to the PSTs on the Polish-German border (Figs. 3 and 4). Control of the PSTs using negative angles causes an increase, while in the positive direction causes a decrease in the volume of active power flows in both cross-border profiles.

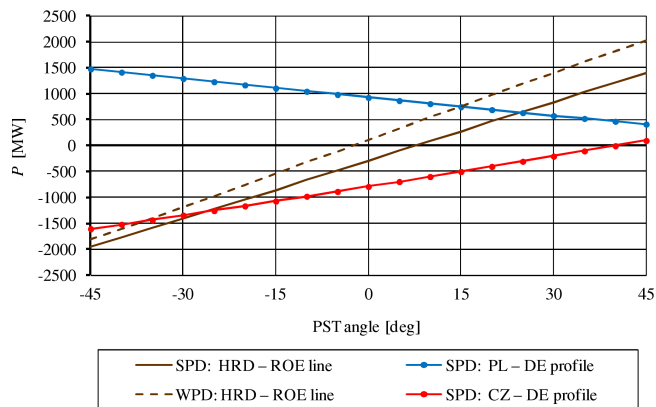

Fig. 8. Impact of parallel control using PSTs installed in the Hradec-Rohrdsdorf tie-line on active power flows

4.3. PSTs on the Polish-German and Czech-German borders. The results show that parallel control using PSTs on both profiles leads to a reduced range of changes in the active power flows (Fig. 9), while opposing control leads to an increased range of changes in the active power flows (Fig. 10). Moreover, it can be noted that the effects obtained for the parallel and opposing control are approximately equivalent to the difference or sum of the effects obtained for the control carried out separately on the Poland-Germany and the Czech Republic-Germany profiles (see Table 1).

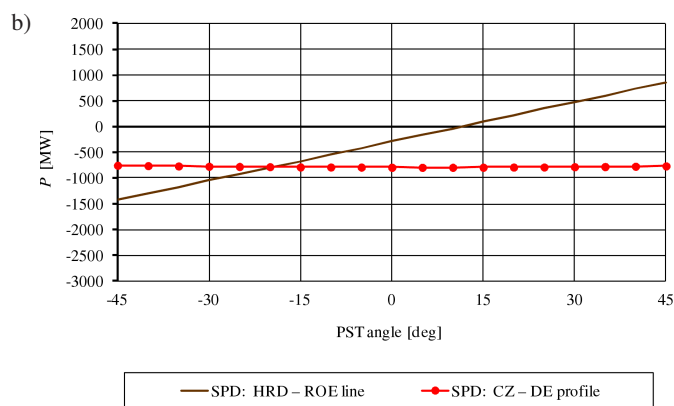
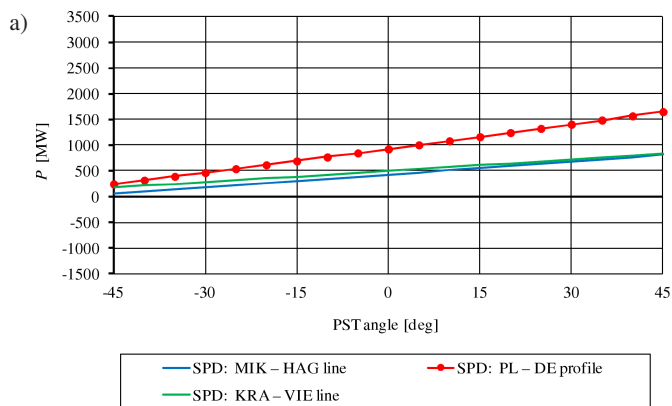

Fig. 9. Impact of parallel control using PSTs installed in the Polish-German and Czech-German (Hradec-Rohrdsdorf) tie-lines on active power flows on the interconnections: a) Poland-Germany, b) the Czech Republic-Germany

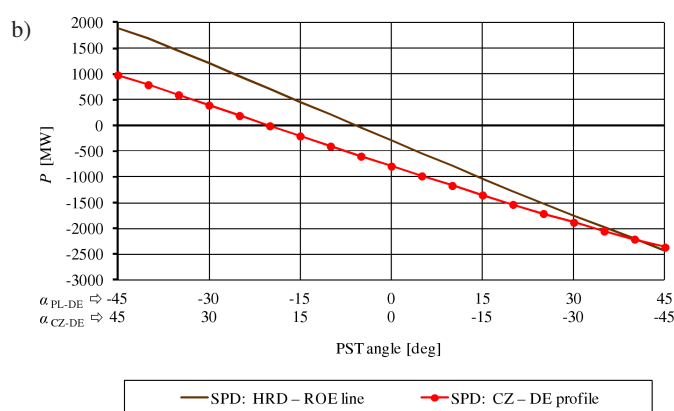
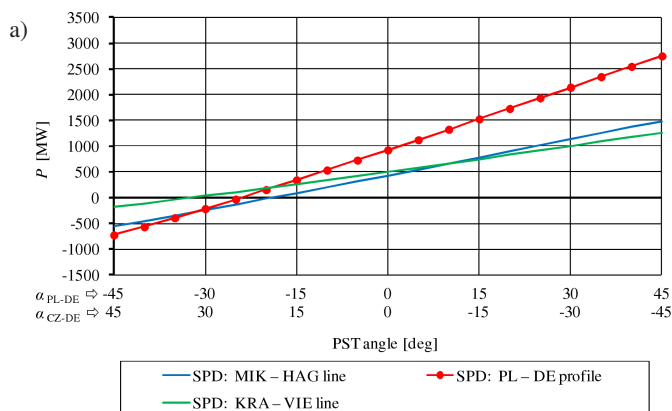

Fig. 10. Impact of opposing control using PSTs installed in the Polish-German and Czech-German (Hradec-Rohrdsdorf) tie-lines on active power flows on the interconnections: a) Poland-Germany, b) the Czech Republic-Germany

Table 1
Possibilities of controlling active power flows on the Polish-German and Czech-German profiles using PSTs

Model	Line/Profile	Averages values of active power flow changes [MW/1°]			
		Variant			
		Parallel control on the PL-DE profile*	Parallel control on the CZ-DE profile**	Parallel control on both profiles	Opposing control on both profiles
summer peak demand 2014	MIK-HAG	15.7	7.4	8.3	22.6
	KRA-VIE	11.7	4.5	7.3	16.0
	PL-DE	27.5	11.9	15.6	38.6
	HRD-ROE	12.0	37.1	25.2	48.0
	CZ-DE	19.1	18.9	0.1	37.1
winter peak demand 2014	MIK-HAG	17.0	9.0	7.9	25.4
	KRA-VIE	12.3	5.1	7.2	17.1
	PL-DE	29.3	14.1	15.1	42.5
	HRD-ROE	14.0	42.7	28.8	55.4
	CZ-DE	20.2	21.0	0.9	40.1

* PSTs installed in the Mikulowa-Hagenverder (MIK-HAG) and Krajnik-Vierraden (KRA-VIE) tie-lines

** PSTs installed in the Hradec-Rohrsdorf (HRD-ROE) tie-line

5. Summary

The main goal of this study was to determine the impact of the installation of PSTs on the Polish-German and Czech-German borders on cross-border power flows, including the potential capability to reduce unscheduled flows. The results of the analysis show that the control of active power flows in the Poland-Germany profile, using the PSTs installed in each circuit of the Mikulowa-Hagenverder and Krajnik-Vierraden lines, gives a significant reduction in active power flowing into Poland from the German system and thus leads to a reduction of unscheduled flows between the power systems of Germany, Poland, the Czech Republic, Slovakia and Austria. However, in order to obtain such effects, PSTs with a sufficiently broad range of phase angle control, of about $\pm 40^\circ$, are required. Such PSTs should also have a rated (throughput) power of at least 750–1000 MVA.

Installation of PSTs on the Poland-Germany interconnections, with a control range of $\pm 40^\circ$, should enable a reduction in unwanted power flows to Poland of approx. 1100 MW. Obtaining the same effect in the absence of PSTs, i.e. when controlling the power flows through cross-border redispatching, would require an increase in generation within the Polish system of approx. 2200 MW, while reducing generation in the German system by the same value. This may not be feasible due to a lack of sufficient power reserves in the Polish system or possible congestions. Therefore, from the perspective of operating safety for the systems combined in the CEE, including the Polish system, the installation of PSTs is justified.

The indicated control capabilities of the PSTs installed on the Poland-Germany interconnections are possible to be achieved, assuming that the control is carried out only on the cross-border profile. The analysis performed for the planned PSTs on the Poland-Germany and the Czech Republic-Germany profiles revealed that the resultant control capabilities of these devices might be subject to “strengthening” or “weakening”. This means that, in order to maximise the controllability, guarantee the secure operation of the in-

terconnected systems as well as ensure adequate possibilities for cross-border energy trade, development of a method for coordinated control of PSTs in the CEE region and appropriate interconnection arrangements are required. The PST control method can be based on metaheuristic optimization algorithms [22], such as particle swarm optimization (PSO) [23–25]. It should be noted that the operation of PSTs affects the operation of neighbouring systems; therefore, their use needs to be preceded by international arrangements.

REFERENCES

- [1] *Bidding Zones Definition*, http://www.pse.pl/uploads/pliki/17225Position_of_CEPS_MAVIR_PSEO_SEPS-Bidding_Zones_Definition.pdf (March 2012).
- [2] *Unplanned Flows in the CEE region*, http://www.pse.pl/uploads/pliki/Unplanned_flows_in_the_CEE_region.pdf (January 2013).
- [3] H. Majchrzak and K. Purchała, “Unplanned power flows and their impact on power system security”, *Electro-energetics – the Present and Development* 3–4, 8–15 (2012), (in Polish).
- [4] H. Majchrzak, G. Tomasik, D. Owczarek, and K. Purchała, “Cross-border unplanned flows in European power system as obstacle towards integrated electricity market”, *Proc. Cigre 7th Southern Africa Regional Conf.* 1, CD-ROM (2013).
- [5] D. Rasolomampionona, “Influence of multiobjective optimization of phase shifting transformer parameters on load and frequency control performance”, *Archives of Energetics* 39 (1), 147–164 (2009), (in Polish).
- [6] P.H. Kim, T. Bach, and L.A. Tuan, “Optimal placement of FACTS in northern power transmission system of Vietnam using an OPF formulation”, *Proc. IEEE Large Engineering Systems Conf. on Power Engineering* 1, 112–117 (2007).
- [7] J. Machowski, J.W. Bialek, and J.R. Bumby, *Power System Dynamic: Stability and Control*, John Wiley and Sons, New York, 2008.
- [8] L. Nogal and J. Machowski, “WAMS – based control of series FACTS devices installed in tie-lines of interconnected power system”, *Archives Electrical Engineering* 59 (3–4), 121–140 (2010).

Impact of phase shifting transformers on cross-border power flows in the Central and Eastern Europe region

- [9] D. Rasolomampionona and S. Anwar, "Interaction between phase shifting transformers installed in the tie-lines of interconnected power systems and automatic frequency controllers", *Int. J. Electr. Power Energy Syst.* 33 (8), 1351–1360 (2011).
- [10] K. Szubert, "Influence of phase shift transformer on distance protection's operation", *Przegląd Elektrotechniczny* 7, 177–181 (2013).
- [11] *Regional Investment Plan Continental Central East*, https://www.entsoe.eu/major-projects/ten-year-network-development-plan/tyndp-2014/Documents/RgIP%20CCE%202014_FINAL.pdf (2014).
- [12] H. Kocot, R. Korab, W. Lubicki, M. Przygodzki, G. Tomasik, and K. Żmuda, "Improving the cross-border transmission capacity of Polish power system by using phase shifting transformers", *Proc. 45th Cigre Session* 1, CD-ROM (2014).
- [13] J. Verboomen, D. Van Hertem, P.H. Schavemaker, W.L. Kling, and R. Belmans, "Phase shifting transformers: principles and applications", *Proc. IEEE Int. Conf. on Future Power Systems* 1, 1–6 (2005).
- [14] P. Bresesti, M. Sforza, V. Allegranza, D. Canever, and R. Vailati, "Application of phase shifting transformers for a secure and efficient operation of the interconnection corridors", *Proc. IEEE Power Engineering Society General Meeting* 2, 1192–1197 (2004).
- [15] D. Hlubek and M. Kolcun, "Use of PST in transmission system of the Slovak Republic", *Przegląd Elektrotechniczny* 2, 79–82 (2011).
- [16] J. Ptacek, P. Modlitba, S. Vnoucek, and J. Cermak, "Possibilities of applying phase-shifting transformers in the electric power system of the Czech Republic", *Proc. 41st Cigre Session* 1, CD-ROM (2006).
- [17] W.L. Kling, D.A.M. Klaar, J.H. Schuld, A.J.L.M. Kanters, C.G.A. Koreman, H.F. Reijnders, and C.J.G. Spoorenberg, "Phase shifting transformers installed in the Netherlands in order to increase available international transmission capacity", *Proc. 40th Cigre Session* 1, CD-ROM (2004).
- [18] J. Warichet, J.-L. Leonard, J. Rimez, O. Bronckart, and J. Van Hecke "Grid implementation and operational use of large phase-shifting transformers in the Belgian HV grid to cope with international network challenges", *Proc. 43rd Cigre Session* 1, CD-ROM (2010).
- [19] E.M. Carlini, G. Manduzio, and D. Bonmann, "Power flow control on the Italian network by means of phase-shifting transformers", *Proc. 41st Cigre Session* 1, CD-ROM (2006).
- [20] D. Van Hertem, "The use of power flow controlling devices in the liberalized market", *PhD Thesis*, Katholieke Universiteit Leuven, Heverlee, 2009.
- [21] X.F. Wang, Y. Song, and M. Irving, *Modern Power Systems Analysis*, Springer, New York, 2008.
- [22] J. Verboomen, "Optimisation of transmission systems by use of phase shifting transformers", *PhD Thesis*, Technische Universiteit Delft, Delft, 2008.
- [23] J. Verboomen, D. Van Hertem, P.H. Schavemaker, F. Spaan, J.M. Delince, R. Belmans, and W.L. Kling, "Phase shifter coordination for optimal transmission capacity using particle swarm optimization", *Electr. Power Syst. Res.* 78 (9), 1648–1653 (2008).
- [24] M. Szczepanik and T. Burczyński, "Swarm optimization of stiffeners locations in 2-D structures", *Bull. Pol. Ac.: Tech.* 60 (2), 241–246 (2012).
- [25] B. Ufnalski and L.M. Grzesiak, "Particle swarm optimization of artificial-neural-network-based on-line trained speed controller for battery electric vehicle", *Bull. Pol. Ac.: Tech.* 60 (3), 661–667 (2012).