

# Transients of electrical and mechanical quantities of a brushless DC motor – computations, measurements\*

MAREK CIURYS, IGNACY DUDZIKOWSKI

*Institute of Electrical Machines, Drives and Measurements, Wrocław University of Technology  
Smoluchowskiego 19, 50-372 Wrocław, Poland*

*e-mail: marek.ciurys@pwr.wroc.pl, ignacy.dudzikowski@pwr.wroc.pl*

(Received: 02.07.2010, revised: 22.11.2010)

**Abstract:** The paper presents a method of computing electrical and mechanical variables of BLDC motors. It takes into account electrical, magnetic and mechanical phenomena in the power supply-converter-BLDC motor-load machine system. The solution to the problem is the so-called circuit-field method. The results determined with the use of time stepping finite element method were used as the parameters of equations of the developed mathematical model. Losses in the motor, losses in transistors and diodes of the converter as well as the actual back EMF waveforms, variable moment of inertia and variable load torque are accounted for. The designed laboratory stand and the test results are presented in the paper. The experimental verification shows the correctness of the developed method, algorithm and program. The developed computational method is universal with respect to different electromechanical systems with cylindrical BLDC motors. It can be applied to electromechanical systems with BLDC motors operating at constant but also variable load torque and moment of inertia.

**Key words:** electrical machines, BLDC motors, permanent magnets, computations, measurements

## 1. Introduction

Brushless DC motors (BLDC motors) show many advantages in comparison to permanent magnet commutator motors; therefore, the number of their applications is still increasing [2, 3, 5]. There is a need to know transients of electrical and mechanical variables for different load torques to determine parameters and electromechanical characteristics of the motors. A complete mathematical model, should take into account the entire electromechanical system, i.e. the power source, the converter, the BLDC motor and the load machine. It is very important to take into consideration different states of the converter operation, actual back EMF wave-

---

\*This is extended version of a paper which was presented at the 21st *Symposium on Electromagnetic Phenomena in Nonlinear Circuits*, Essen-Dortmund, 29.06-02.07, 2010.

forms, variations of the moment of inertia, load torque variations, losses in the converter and losses in the motor as well as the influence of temperature on the permanent magnets demagnetization curve, the value of magnetic flux, the resistance to demagnetization, the parameters of the converter and power losses in the system.

The scope of the work is as follows:

- developing a mathematical model of a brushless DC motor,
- developing a computational program,
- presenting the procedure of computations,
- computing transients of electrical and mechanical variables as well as electromechanical characteristics of the motor,
- presenting the designed laboratory stand,
- measuring transients of electrical and mechanical quantities and determining the electro-mechanical characteristics of the BLDC motor,
- comparing the computations results with the laboratory test results.

## 2. The mathematical model of the BLDC motor

The developed mathematical model of the BLDC motor takes into account all six operating states of the converter (Figures 1 and 2). The different operating states result from conduction of different transistors and diodes of the converter (Figure 1 and 2). Table 1 shows the derived current and voltage equations describing the operation of the motor in the first state (Figure 2). The time interval in which the current of the phase (which is to be disabled) flows through the *D6* feedback diode has been defined as the commutation interval. The conduction interval, on the other hand, corresponds to the state in which the current flows only through two phases (phase *a* and phase *b*) of the armature winding.

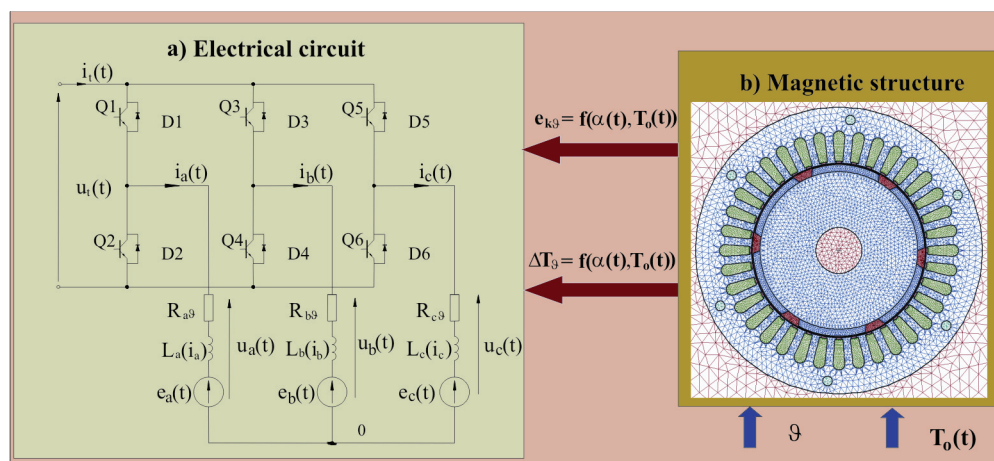

Fig. 1. Magnetic structure and electrical circuit of the BLDC motor with converter

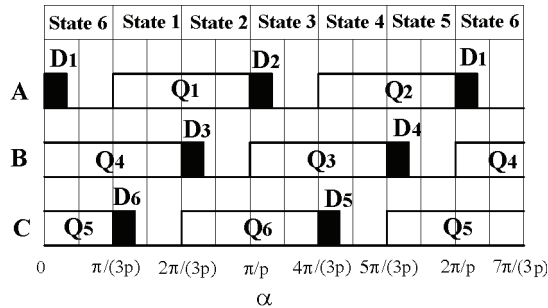

Fig. 2. The sequence of switching transistors and diodes of the converter as a function of the mechanical angle of rotor rotation

The mathematical model of the drive takes into account, inter alia:

- the actual back EMF waveforms induced in the winding phases dependent on the rotor angular position, the temperature and the value of the load torque,
- the power losses in the motor armature windings and in the converter which depend on the value of the current,
- the losses in the stator iron. These losses are calculated through the classic method based on the induction values in the magnetic structure of the motor which were determined with the use of time stepping finite element method.

In Figures 1 and 2 and Table 1, the symbols stand for the following variables:  $i_t(t)$  – the instantaneous value of the current taken by the system,  $u_t(t)$  – the instantaneous value of the voltage at the input of the converter,  $Q1 \dots Q6$  – transistors of the converter,  $D1 \dots D6$  – feedback diodes of the converter,  $i_a(t)$ ,  $i_b(t)$ ,  $i_c(t)$  – the instantaneous values of the currents in the armature windings of  $a$ ,  $b$  and  $c$  phases,  $R_\vartheta$  – the resistance of the armature winding phases at  $\vartheta$  temperature,  $L$  – the inductance of the armature winding phases dependent on the value of the current,  $e_a(t)$ ,  $e_b(t)$ ,  $e_c(t)$  – the instantaneous values of back EMFs induced in the armature winding phases,  $u_a(t)$ ,  $u_b(t)$ ,  $u_c(t)$  – the instantaneous values of the voltages at the motor winding phases  $a$ ,  $b$  and  $c$ ,  $\Delta u_{tr}(i_k(t), f_p(t))$  – the voltage drop on the converter transistor which relies on the conduction losses and switching losses in the transistor ( $k = a, b$  or  $c$ ),  $\Delta u_d(i_k(t), f_p(t))$  – the voltage drop on the converter feedback diode which takes into account the conduction losses and switching losses in the feedback diode,  $f_p(t)$  – the switching frequency.

The instantaneous value of the voltage drop on the transistor

$$\Delta u_{tr}(i_b(t), f_p(t)) = \Delta u_{trp}(i_b(t)) + \Delta u_{trr}(i_b(t), f_p(t)). \quad (1)$$

where:  $\Delta u_{trp}(i_b(t))$  – instantaneous value of the voltage drop on the transistor resulting from conduction losses in the transistor.

The instantaneous value of the voltage drop on the transistor resulting from switching losses in the transistor is represented by the following equation (2):

$$\Delta u_{trr}(i_b(t), f_p(t)) = \frac{\Delta P_{trr}(f_p(t))}{i_b(t)}. \quad (2)$$

Switching losses of the transistor  $\Delta P_{tr1}(f_p(t))$  are determined by taking into account wasted energy (from catalogue data) related to the time when the transistor is on (Fig. 3)

$$\Delta P_{tr1}(f_p(t)) = \frac{(W_{ztr} + W_{wtr}) \cdot \omega(t) \cdot p}{\alpha_{tr}}, \quad (3)$$

where:  $W_{ztr}$  – energy wasted at the transistor switching on,  $W_{wtr}$  – energy wasted at the transistor switching off,  $\alpha_{tr}$  – angle of transistor work (Fig. 3),  $p$  – number of pole pairs,  $\omega(t)$  – angular speed.

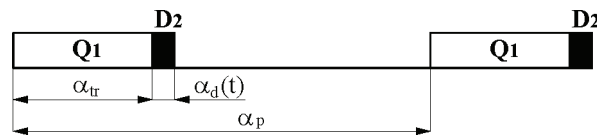

Fig. 3. The illustration of the angle of the transistors and diodes work

The instantaneous value of the voltage drop on the feedback diode is

$$\Delta u_d(i_c(t), f_p(t)) = \Delta u_{dp}(i_c(t)) + \Delta u_{dl}(i_c(t), f_p(t)), \quad (4)$$

where:  $\Delta u_{dp}(i_c(t))$  – instantaneous value of the voltage drop on the feedback diode resulting from conduction losses in the diode.

The instantaneous value of the voltage drop on the feedback diode resulting from switching losses in the diode is

$$\Delta u_{dl}(i_c(t), f_p(t)) = \frac{\Delta P_{dl}(f_p(t))}{i_c(t)}. \quad (5)$$

Switching losses of the feedback diode  $\Delta P_{dl}(f_p(t))$  are calculated with use of wasted energy (from catalogue data) related to the time when the feedback diode is on (Fig. 3)

$$\Delta P_{dl}(f_p(t)) = \frac{(W_{zd} + W_{wd}) \cdot \omega(t) \cdot p}{\alpha_d(t)}, \quad (6)$$

where:  $W_{zd} + W_{wd}$  – energy wasted at the diode switching on and off,  $\alpha_d(t)$  – angle of the feedback diode work (Fig. 3).

The instantaneous value of the EMF induced in the  $k$  phase ( $k = a, b$  or  $c$ ) of the armature winding, at  $\vartheta$  mperature is calculated as follows

$$e_k(t) = c_{ek\vartheta}(\alpha, T_o(t)) \cdot \omega(t), \quad (18)$$

where:  $\omega(t)$  – the instantaneous value of the angular speed of the motor,  $c_{ek\vartheta}(\alpha, T_o(t))$  – coefficient of proportionality between the value of the instantaneous EMF  $e_k(t)$  and the instantaneous value of the angular speed  $\omega(t)$ . The coefficient  $c_{ek\vartheta}(\alpha, T_o(t))$  is determined through the time stepping finite element method [1].

Table 1. The BLDC motor equations for the first state of the converter operation

First state of the converter operation	Commutation interval	$u_{bc}(t) = \Delta u_d(i_c(t), f_p(t)) - \Delta u_{tr}(i_b(t), f_p(t))$	(7)
		$u_{ab}(t) = u_t(t) - \Delta u_{tr}(i_a(t), f_p(t)) + \Delta u_{tr}(i_b(t), f_p(t))$	(8)
		$\frac{di_a(t)}{dt} = \frac{1}{3L} \cdot \left( \begin{array}{l} 2 \cdot u_{ab}(t) + u_{bc}(t) - 2 \cdot e_a(t) + \\ + e_b(t) + e_c(t) - 3 \cdot R_g \cdot i_a(t) \end{array} \right)$	(9)
		$\frac{di_b(t)}{dt} = \frac{1}{L} \cdot \left( \begin{array}{l} e_a(t) - e_b(t) + R_g \cdot (i_a(t) - i_b(t)) + \\ + L \frac{di_a(t)}{dt} - u_{ab}(t) \end{array} \right)$	(10)
		$\frac{di_c(t)}{dt} = - \frac{di_a(t)}{dt} - \frac{di_b(t)}{dt}$	(11)
		$i_t(t) = i_a(t)$	(12)
	Conduction interval	$u_{ab}(t) = u_t(t) - \Delta u_{tr}(i_a(t), f_p(t)) + \Delta u_{tr}(i_b(t), f_p(t))$	(13)
		$\frac{di_a(t)}{dt} = \frac{1}{2 \cdot L} \cdot \left( \begin{array}{l} u_{ab}(t) - e_a(t) + e_b(t) + \\ + R_g \cdot (-i_a(t) + i_b(t)) \end{array} \right)$	(14)
		$\frac{di_b(t)}{dt} = - \frac{di_a(t)}{dt}$	(15)
		$\frac{di_c(t)}{dt} = 0$	(16)
		$i_t(t) = i_a(t) = -i_b(t)$	(17)

The value of this coefficient changes with time and it depends on the rotor angular position and on the value of the load torque. It relies on the actual back EMF waveform for a given load torque. The method by which this coefficient of proportionality is determined is summarized as follows:

- the time stepping finite element computations are carried out at different values of the load torque  $T_o$  at different temperature  $\vartheta$ ,
- the coefficient is determined for each phase from the computed transients of the back EMF in a single phase and the computed transients of the angular speed in accordance with the equation below:

$$c_{ek\vartheta}(\alpha, T_o(t)) = \frac{e_k(t)}{\omega(t)} \tag{19}$$

The coefficients  $c_{ek\vartheta}(\alpha, T_o(t))$  of the phases ( $a$ ,  $b$  and  $c$ ) are shifted at  $120^\circ$ .

The instantaneous value of the electromagnetic torque of the motor in  $\vartheta$  temperature is calculated as follows

$$T_{e\vartheta}(t) = \sum_{k=a,b,c} \frac{e_k(t) \cdot i_k(t)}{\omega(t)} + \Delta T_{\vartheta}(\alpha, T_o(t)) = \sum_{k=a,b,c} c_{ek\vartheta}(\alpha, T_o(t)) \cdot i_k(t) + \Delta T_{\vartheta}(\alpha, T_o(t)), \quad (20)$$

where:  $\Delta T_{\vartheta}(\alpha, T_o(t))$  – electromagnetic torque pulsations of the motor at  $\vartheta$  temperature, at the  $T_o$  load torque. These pulsations are determined by the time stepping finite element method using a commercial software.

The equation of motion for the considered system is

$$J(t) \cdot \frac{d\omega(t)}{dt} + \frac{\omega(t)}{2} \cdot \frac{dJ(t)}{dt} = T_{e\vartheta}(t) - T_o(t), \quad (21)$$

where:  $J(t)$  – moment of inertia.

Equations (1)-(21) illustrate the essence of the developed mathematical model of the BLDC motor with a converter and the method using the actual back EMF waveform, variable load torque and variable moment of inertia. The complete mathematical model of the BLDC motor with a converter is presented in [1]. In comparison to the state of the issue in the literature, e.g. [2-4, 6], the developed mathematical model is more precise [1], as it relies on:

- the actual back EMF waveform at different load torques,
- the dependence of the converter power losses as a function of the current and the frequency.

It is possible to apply the developed method for analysing the electromechanical systems operating at variable load torque and variable moment of inertia [1], i.e. in car starters. Such an analysis is not possible with available commercial software (i.e. Flux, Maxwell). On the basis of the presented mathematical model a program for computation of transients of electrical and mechanical quantities of a BLDC motor has been developed in the Matlab environment.

The procedure of computations is as follows:

- the time stepping finite element computations are carried out by different values of the load torque in different temperature,
- the actual back EMF waveforms  $e_{k\vartheta}$  and the pulsations of the electromagnetic torque of the motor  $\Delta T_{\vartheta}$  are determined with the help of time stepping finite element method,
- the values determined by the time stepping finite element method (with the help of commercial software) are used as the parameters in electrical circuit equations,
- the instantaneous values of electrical and mechanical quantities are computed for each angle of the rotor rotation  $\alpha$ .

It is possible to determine the electromechanical characteristics of the BLDC motor when the transients of electrical and mechanical quantities are computed.

### 3. The description of the analysed motor

The analysis has been carried out on a three phase motor with NdFeB magnets. The motor has the following parameters: voltage  $U_n = 24$  V, power  $P_n = 300$  W, rotational speed  $n_n = 1500$  rpm.

#### 4. Computations results

Transients of the electrical and mechanical variables (at the rated load torque) as well as the electromechanical characteristics of the motor, computed with the use of the developed program, are shown in Figures 4-6.

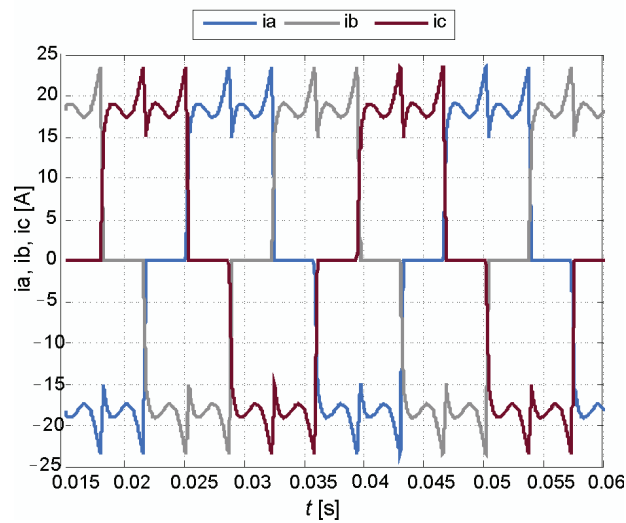

Fig. 4. Transients of the phases currents

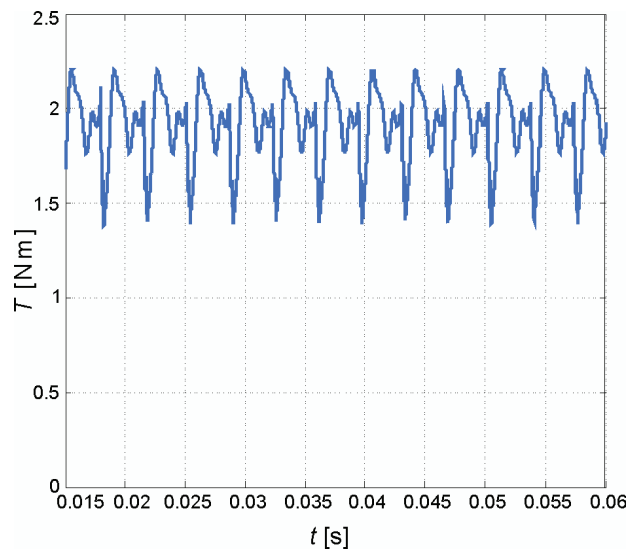

Fig. 5. Transient of the mechanical torque of the motor

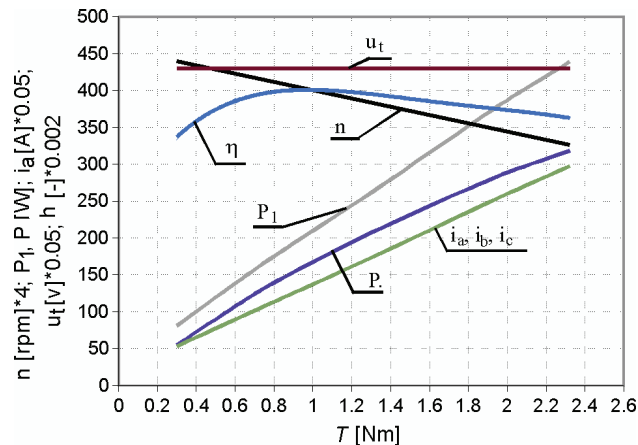

Fig. 6. Electromechanical characteristics of the motor

## 5. Description of the laboratory stand

The diagram of the laboratory stand is shown in Fig. 7, while the view is presented in Fig. 8. The laboratory stand consists of a power supply, a converter, a BLDC motor, a torque transducer, a dynamometer with peripherals, an encoder, a PC with a data acquisition card and the developed program in the LabVIEW environment, which enables the electrical and mechanical transients registration. The data acquisition card has 8 analog inputs which can be simultaneously sampled at the frequency of 500 kHz per channel. Measurements of the instantaneous values of the current taken from the power supply and the phases currents of the motor were performed with the use of the HAL 100-S type transducers. The instantaneous values of the phases voltages were measured by the use of a differential probe. The mechanical torque was measured by the use of the S-0260DM50W torque transducer. Sendix 5020 series encoder (3600 pulses per turn) was used to measure the speed. The motor was loaded by the power dynamometer; stabilized power supply was used.

The instantaneous values of the measured signals are transmitted through the BNC 2110 connecting module to the data acquisition card. The converter contains the IRFI3205 MOSFET transistors connected in a typical configuration of the 6-pulse bridge. It enables, among other things, to change the direction of motor rotation and to control the speed by PWM. There are two feedback loops in the system. A position feedback, required for proper operation of the motor and the current feedback, which protects the motor against the effects of too large currents. Rotor position signals, obtained from the reflective transoptors cooperating with a shield reflecting infrared radiation, were used to switch on the proper winding phases.

A virtual measuring instrument has been developed in the LabVIEW environment. It allows to communicate with the data acquisition card, to preview and to register the measured transients and their average and rms values.



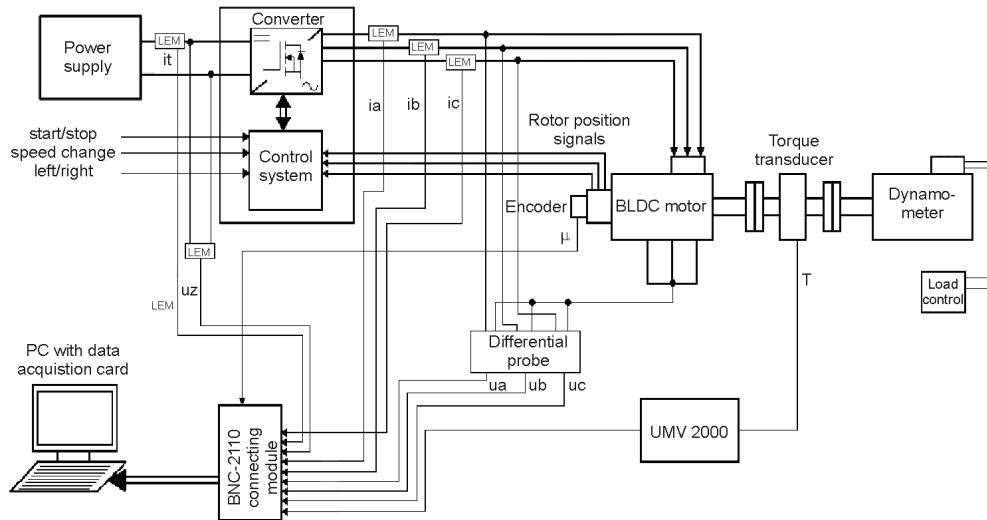

Fig. 7. Diagram of the laboratory stand

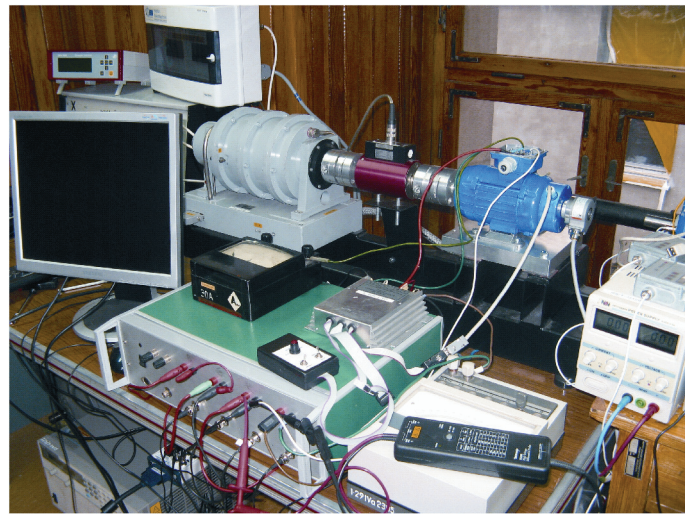

Fig. 8. View of the laboratory stand

## 6. Experimental results

Measured transients of the electrical and mechanical variables (at the rated load torque) as well as determined (from measurements) electromechanical characteristics of the motor are shown in Figures 9-11. The time  $t = 0$  (in the Figures 9-11) stands for the starting time of transients registration.

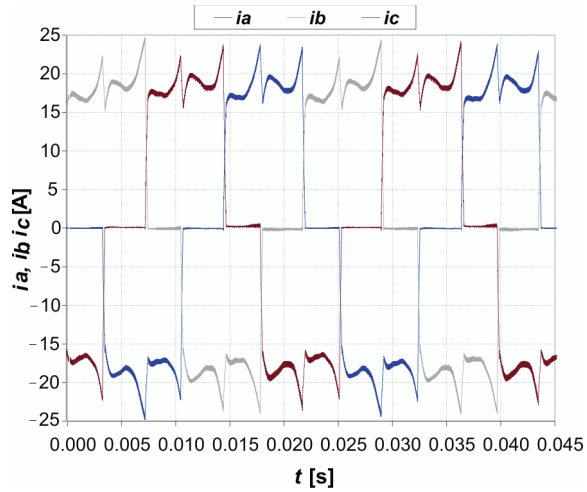

Fig. 9. Transients of the phases currents

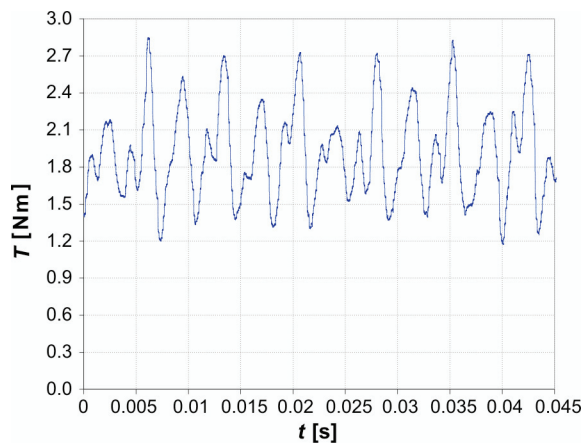

Fig. 10. Transient of the mechanical torque of the motor

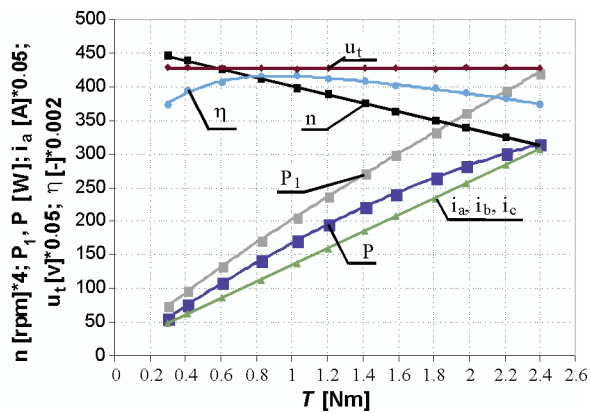

Fig. 11. Electromechanical characteristics of the motor

## 7. Conclusion

In the study a mathematical model and a program for computation of transients of electrical and mechanical quantities of a BLDC motor were developed. Transients of electrical and mechanical variables as well as electromechanical characteristics of the BLDC motor were computed. The laboratory stand with the software for monitoring and registration of transients of the BLDC motor was developed. Also, transients of the electrical and mechanical variables as well as electromechanical characteristics were measured.

The differences between the calculated and measured average values of mechanical and electrical quantities which were determined from transients (at the rated load torque) are respectively (Figures 6 and 11):

- in the phases currents 0.8%,
- in the phases voltages 4.8%,
- in the rotational speed 1.7%,
- in the efficiency 4.3%,
- in the mechanical power 1.7%.

The maximum difference between the average computed values and measured does not exceed 6% (in the range of load torque change from 0.5 to 1.25  $T_n$ ).

This certainly demonstrates the correctness of the developed mathematical model, algorithm and program and their suitability for the computational analysis of brushless DC motors.

Differences between the calculated and measured transients of electrical and mechanical variables and electromechanical characteristics result from (among others):

- the difference between the actual parameters and catalogue parameters of the permanent magnets; according to the catalogue data, differences between the remanence values reach up to 3.5%; for coercitivity these differences equal 6.6%;
- the difference between the actual geometric dimensions of the motor components and the dimensions given in the documentation;
- the asymmetry of the magnetic structure;
- the difference between the actual parameters and catalogue parameters of the converter transistors and diodes;
- the inaccuracy in alignment of the system: motor-clutch-torque transducer-clutch-dynamometer (Figures 7 and 8); the inaccuracy of alignment causes the load torque pulsation at rotation frequency and thereby the electromechanical torque of the motor changes as well;
- the inaccuracy of the used measurement instruments; the inaccuracy of the LEM transducers was 1% and the torque transducer 1.3% (at the rated load torque of the motor); the largest inaccuracy occurred in phases voltage measurements; this inaccuracy was estimated at 3%.

When all these factors are taken into account, the accuracy of the obtained results should be considered as satisfactory.

## References

- [1] Ciurys M., *Analysis of a BLDC motor operation at variable load on the example of a car starter*. (In Polish), Wrocław University of Technology, Institute of Electrical Machines, Drives and Measurements Report (PhD thesis), PRE Nr 4 (2009).

- 
- [2] Chen J., Guo Y., Zhu J., Jin J., *Performance analysis of a surface mounted permanent magnet brushless DC motor using an improved phase variable model*. Industry Applications Conference, 42nd IAS Annual Meeting. Conference Record of the 2007 IEEE, pp. 2169-2174 (2007).
  - [3] Gieras J.F., *Permanent Magnet Motor Technology, Design and Applications*. 3rd ed., CRC Press Taylor & Francis Group, NY (2009).
  - [4] Jeon Y.S., Mok H.S., Choe G.H. et al., *A new simulation model of BLDC motor with real back EMF waveform*. Proc. of the 7th Workshop on Computers in Power Electronics, Blacksburg, VA, USA, pp. 217-220 (2000).
  - [5] Krishnan R., *Permanent Magnet Synchronous and Brushless DC Motor Drives*. CRC Press, Taylor & Francis Group, NY (2009).
  - [6] Xiangjun Z., Boshi C., *The different influences of four PWM modes on the commutation torque ripples in sensorless brushless DC motors control system*. Proceedings of the Fifth International Conference on Electrical Machines and Systems ICEMS 2001 1: 579-582 (2001).