

Sensorless control of SRM at medium speed range

KONRAD URBAŃSKI

*Institute of Control and Information Engineering, Poznan University of Technology
Piotrowo 3A, 60-965, Poznań, Poland
e-mail: konrad.urbanski@put.poznan.pl*

(Received: 02.07.2010, revised: 09.12.2010)

Abstract: The paper deals with the problem of position and speed estimation methods in SRM (Switched Reluctance Motor) drive equipped with hysteresis band current controller with MRAS (Model Reference Adaptive System) type observer. An adaptive flux model uses equation set of one-dimensional equations instead of one two-dimensional equation. The reference model is the formal one. Instead of measured current the observer utilizes reference current. Such drive system works well at speed range up to 600 rad/s. The observer's gains must change depend on the speed range. The robustness on motor parameter poor estimation is presented.

Key words: MRAS, Sensorless Control, SRM, Switched Reluctance Motor

1. Introduction

Switched Reluctance Motors (SRM) are relative simple machines. The advantages of those motors are high reliability, easy maintenance and good performance. Such type of motor has ability to achieve very high speeds – over 10000 rpm. The drawback is complex algorithm to control it as a high degree of nonlinear object. SRMs must always be electronically commutated and requires a shaft position sensor to operate. The high speed operation results in very fast current changes and limits usage of traditional structures of current controller in micro-processor realizations. Instead a usage of hardware based current controller is required. Such current controller realization requires a special structure of the position estimator. The main features of current control loop equipped in hysteresis band current controller are variable switching frequency in inverter and absence of reference or measured voltage value (due to high switching frequency). Position is estimated using properly prepared reference current instead of measured one and voltage integrated by hardware part of estimator.

2. The SRM model

Based on a well-known motor model, the base equation set can be described as follows [2, 3, 4]:

$$\frac{d\boldsymbol{\Psi}}{dt} = -R \cdot \mathbf{I} + \mathbf{U}, \quad (1)$$

$$\frac{d\Theta}{dt} = \omega, \quad (2)$$

$$\frac{d\omega}{dt} = \frac{1}{J} (T - T_L), \quad (3)$$

$$\boldsymbol{\Psi} = f(\Theta, \mathbf{I}), \quad (4)$$

$$T = f(\Theta, \mathbf{I}), \quad (5)$$

where \mathbf{I} , $\boldsymbol{\Psi}$, are the vectors of stator current and stator flux linkage, \mathbf{U} is the vector of stator voltage, R is the stator windings resistance, ω and Θ are the rotor speed and the position, J is the moment of inertia, T is electromagnetic torque and T_L is the load torque.

The well-known model utilizes 2D functions as torque $T(\Theta, \mathbf{I})$ and flux $\boldsymbol{\Psi}(\Theta, \mathbf{I})$. One can use a simplified two 1-dimensional nonlinear equation ($L_\Theta(\Theta)$ and $\text{sat}(\mathbf{I})$) instead of one 2-dimensional [3]:

$$\boldsymbol{\Psi}(\Theta, \mathbf{I}) = L_C \cdot \mathbf{I} + L_\Theta(\Theta) \cdot \text{sat}(\mathbf{I}) \quad (6)$$

and

$$T(\Theta, \mathbf{I}) = \frac{dL_\Theta(\Theta)}{d\Theta} \cdot \int_0^{\mathbf{I}} \text{sat}(\mathbf{t}) d\mathbf{t}, \quad (7)$$

where L_C is constant component of phase inductance at unaligned rotor position, L_Θ can be considered as a position-dependent component of non-saturated inductance, sat and $d\text{sat}$ are the saturation and derivative of saturation functions.

Formula (6) and the voltage equation can be converted into (8). So, the one phase of SRM can be described by the equation:

$$\frac{di}{dt} = \frac{u - Ri - \omega \cdot \frac{dL_\Theta(\Theta)}{d\Theta} \cdot \text{sat}(i)}{L_C + L_\Theta(\Theta) \cdot \frac{d\text{sat}(i)}{di}}. \quad (8)$$

Nonlinear functions: $L_\Theta(\Theta)$, $\text{sat}(i)$ and its integrals and derivatives can be calculated from flux or torque characteristics. Based on equation (7) and (8), one can prepare such model of SRM [3].

The $\text{ssat}(i)$ block from Figure 1 means integration of saturation function presented in (7). The thick lines means there are a few layers (each model layer for one phase) and thin lines are scalar signals. Symbol “q” denotes shaft position, symbol “Q” denotes vector of electrical angles for each phase.

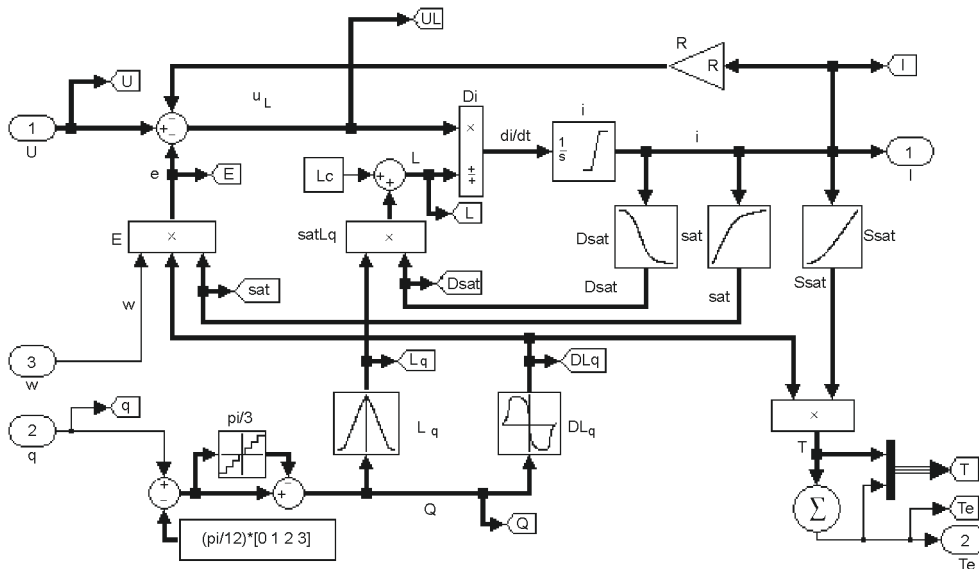

Fig. 1. Block structure of the mathematical model of SRM

3. The SRM observer

The observer structure consists of two parts: hardware implemented voltage integrator and the second one, software realised calculations.

One can convert equation (1) into:

$$\Psi(t) = \int (-R \cdot \mathbf{I} + \mathbf{U}) dt. \tag{9}$$

The flux one can calculate from (6) too. An analyzed control system of SRM drive includes hysteresis band current controller. Such control method forced modification of observer's structure. Instead of measured current the observer utilizes reference current $- \mathbf{I}_{ref}$ (applicable modulated). Thus yields the equation

$$\hat{\Psi}(\Theta, \mathbf{I}) = L_C \cdot \mathbf{I}_{ref} + L_{\Theta}(\hat{\Theta}) \cdot sat(\mathbf{I}_{ref}), \tag{10}$$

where symbol “^” denotes estimated quantities.

Substitution of \mathbf{I}_{ref} into equation (9) gives

$$\Psi^*(t) = \int (-R \cdot \mathbf{I}_{ref} + \mathbf{U}) dt. \tag{11}$$

Calculation of the Ψ^* consist of two parts – voltage integration evaluated by hardware and $R \cdot \mathbf{I}_{ref}$ integration evaluated by software.

The difference between (10) and (11) yields the quality benchmark of position calculation for each phase:

$$\Delta \Psi = \Psi^* - \hat{\Psi}. \quad (12)$$

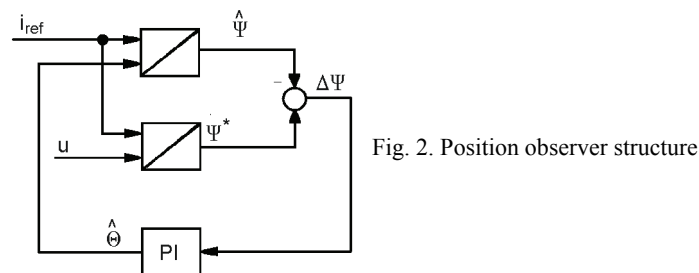

Fig. 2. Position observer structure

Additional correction object PI (Fig. 2.) causes minimisation of position estimation error during transient state for each phase. Its output signal one can describe as below:

$$\hat{\Theta} = K_P \cdot \Delta \Psi + K_I \int \Delta \Psi dt, \quad (13)$$

where K_P means proportional gain factor and K_I means integral gain factor. The output vector evaluates computational position for each phase separately. Speed is calculated by sum of the derivation of estimated position vector elements.

4. Simulation results

Simulation investigations were carried out in MATLAB-Simulink environment. The motor model was calculated with small step of integration – $0.1 \div 1 \mu\text{s}$ what gave its quasi continuous character and in opposition to this the model of control system together with observer was calculated with step about $100 \mu\text{s}$, what simulates its microprocessor realisation. All waveforms are achieved for closed loop mode. Observer parameters K_P and K_I were carried out using RWC algorithm [1]. This method was proven in previous project [5]. Simulations were achieved for SRM 8/6 with nominal parameters: 1.32 kW, 48 V, 6000 rpm.

The first set of waveforms was carried out using observer's motor model and tested motor parameters equal. Some of the obtained waveforms are presented at Figures 3 and 4. The test waveforms were achieved during start (motor unloaded) up to 600 rad/s and then load changed at time 0.15 s into nominal value. Figure 3 presents waveforms of the speed during transients – real speed and estimated one after filtering process. Figure 4 shows real and filtered position estimation error focused at the moment of load change.

The second part was carried out for different parameters of motor and observer's motor model. Several tests were performed. The robustness on motor resistance and inductance poor estimation were carried out. Figure 5 shows speed waveforms during unloaded motor start from zero up to 600 rad/s. The estimator's resistance (11) is equal motor's phase resistance and inductance L_C (10) is varying. Figure 6 shows the same dynamic test as in previous figure was but now the estimator's inductance L_C is equal the motor's one and estimator's resistance

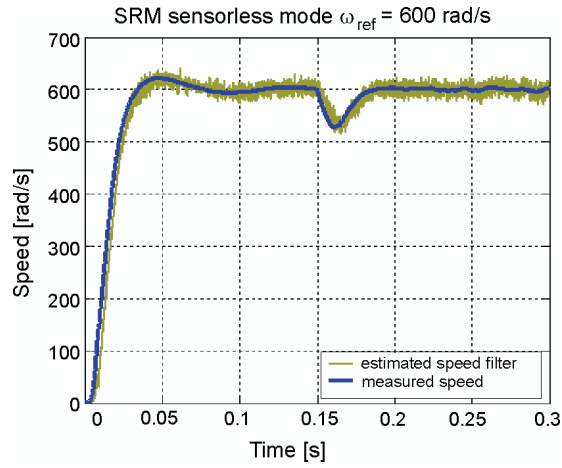

Fig. 3. Real and estimated speed during starting into 600 rad/s, step change of motor load at $t = 0.15$ s

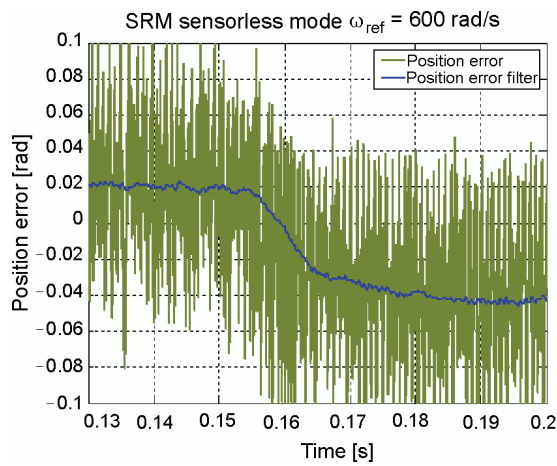

Fig. 4. Position estimation error. Step change of motor load at $t = 0.15$ s

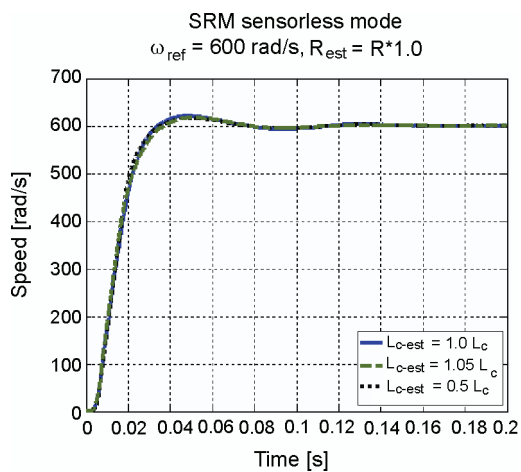

Fig. 5. Real speed during starting into 600 rad/s for poor estimation of motor inductance L_c , motor resistance equal observer's ones

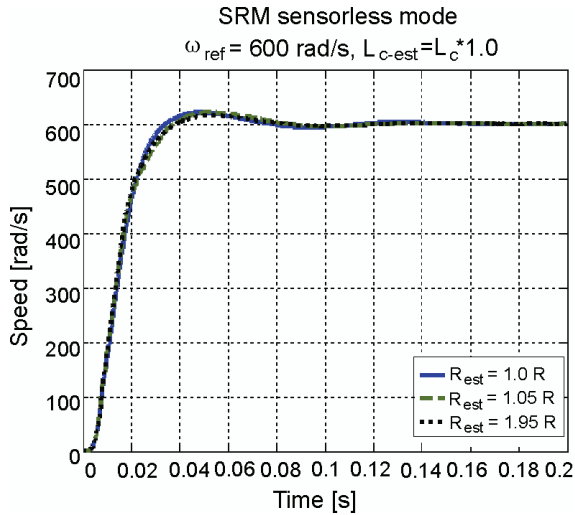

Fig. 6. Real speed during starting into 600 rad/s for poor estimation of motor resistance, motor inductance L_c equal observer's ones

is varying. There is no significant influence into speed waveforms at presented values change range but one can notice the acceptable inaccuracy in resistance estimation for presented method is quite small: $\pm 5\%$. The acceptable range of inaccuracy in estimation inductance L_c is bigger: 50-105% of motor's parameter.

Influence of the observer's parameters variation is more visible at the position error waveforms – Figures 7 and 8. You can notice the change of observer's parameter value may change the sign of position error. Rough position error waveforms are caused by hybrid calculation method of equation (11) – voltages are integrated by hardware (variable switching period) although the currents are integrated by software (constant calculation period).

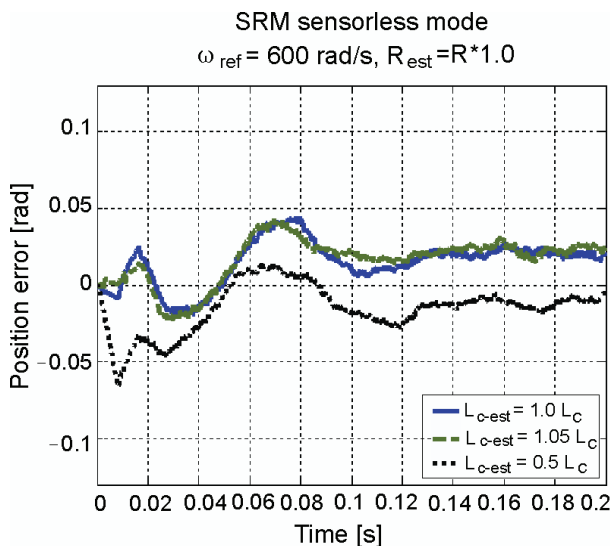

Fig. 7. Position error during starting into 600 rad/s for poor estimation of motor inductance L_c , motor resistance equal observer's ones

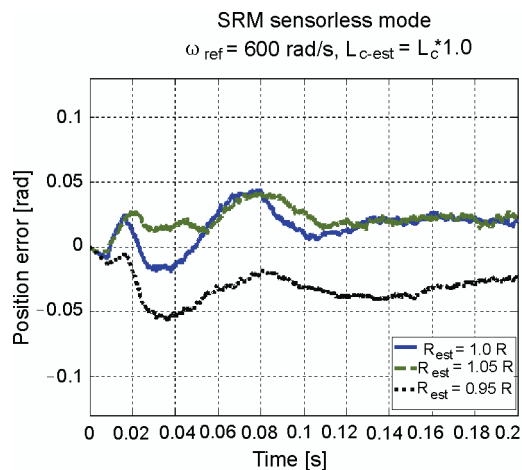

Fig. 8. Position error during starting into 600 rad/s for poor estimation of motor resistance, motor inductance L_c equal observer's ones

4. Conclusions

In the paper a SRM's position observer is presented. The hybrid calculation method of the position estimation is modelled and successfully used. This structure gives good accuracy of observation and do not involve high frequency oscillations in observed signals. Due to non-linearity of SRM and usage of hysteresis band current controller, observer parameters should vary depends of motor speed. With prepared set of observer parameters drive works well at medium speed range: up to 600 rad/s. The control loop uses estimated values of position and speed instead measured ones. Even though a high degree of nonlinearity of SRM, the observer generates proper position signal, which can be easy calculated into speed with adequate accuracy. Simulation results gave good recommendation for practical realisation of analysed observer algorithm by means of signal processor.

References

- [1] Burton B., Kamran F., Harley R.G. et al., *Identification and Control of Induction Motor Stator Currents Using Fast On-Line Random Training of a Neural Network*. IEEE Transactions On Industry Applications 33(3) (1997).
- [2] Krishnan R., *Switched reluctance motor drives. Modeling, Simulation, Analysis, Design, and Applications*. CRC Press Boca Raton, London, New York, Washington (2001).
- [3] Maciejuk A., Deskur J., *Modelling of switched reluctance motor drive*. Proc. of Symposium on Electromagnetic Phenomena in Nonlinear Circuits, Maribor, Slovenia, pp. 159-160 (2006).
- [4] Soares F., Costa Branco P.J., *Simulation of a 6/4 switched reluctance motor based on Matlab/Simulink environment*. IEEE Trans. Aerosp. Electron. Syst. 37(3): 989-1099 (2001).
- [5] Urbański K., Zawirski K., *Adaptive observer of rotor speed and position for PMSM sensorless control system*. COMPEL, The International Journal for Computation and Mathematics in Electrical and Electronic Engineering 23(4): 1129-1145 (2004).