

HYDRODYNAMIC AND KINETIC STUDY OF AN ELUTION OF A HIGH VISCOSITY LIQUID FROM THE SAND BED USING ELUENT OF LOW VISCOSITY

Jerzy Sęk^{*}, Mariola Błaszczyk, Michał Bartos

Technical University of Lodz, Faculty of Process and Environmental Engineering,
ul. Wólczajska 213, 90-924 Łódź, Poland

The study was aimed to determine the hydrodynamic of water seepage through a porous bed saturated with different amounts of high viscosity liquids. An attempt was made to describe the process of seepage through beds saturated with oils using the theory of outflow of a liquid from the tank. It was assumed that the discharge coefficient will represent changes of flow resistance during the process. It was found that the dependence of this factor on time is linear. In the second part of this work kinetics of the seepage process was investigated. Dependence of oil concentrations, eluted from the deposit with the flowing water, on time has been evaluated. Thanks to these studies it was possible to determine the effectiveness of an elution of high viscosity liquids from porous beds using water as the washing out liquid.

Keywords: granular bed, porous beds, elution, permeability, kinetic

1. INTRODUCTION

The problems of the flow of liquids through porous media belongs to the fields of a research of chemical and process engineering. One of the aspects of such investigations are the studies of the phenomena of elution of high viscosity liquids from such structures using eluents of low viscosity. Results can be applied in the design of extraction, leaching and filtration processes or soils remediation. They also provide data for mathematical modeling of such multiphase flows.

Bodies with an internal porous structure are materials of natural origin or are products of technological processes. Different kinds of rock and soil belong to the first group, ceramic materials, concrete, foamed plastics belong to the second one. Such porous materials and mainly soils can be saturated with water or different kinds of fluids such as impurities in the form oil derivatives (Izabelska – Mucha D., 2005, Łebkowska M. et al., 1997, Korzeniowska E., 1997). These impurities may appear as a result of large-scale disasters, accidents of tanks, cisterns or pipelines. Soil saturation with oil can also occur as a result of mining processes, processing refineries, accidental spills.

The effects of soil contamination by oil derivative substances pose a direct threat to the environment, as well as for man. Investigations (Surygała J., 2000, Surygała J., 2001) show that the presence of petroleum in the soil adversely affects its physical and mechanical properties. The presence of such compounds in the soil can also lead to disorders in relationships of organic carbon to nitrogen and phosphorus, which interferes with normal development of biological life, and also reduces water capacity of the soil and prevents exchange of air in soil pores.

^{*}Corresponding author, e-mail: jerzysek@p.lodz.pl

Hydrocarbonic pollutants are very often removed from soils and ground layers during remediation processes. Environmental remediation deals with the elimination or neutralization of contaminants and can be the result of biological processes when several types of microorganism or bacteria are used. Remediation (Lowe D.F., et al. 1999, Moldrup P. 1996, Moldrup P., Loll P.: 2000), can be also performed as the result of hydraulic processes including extraction techniques or surfactant enhanced aquifer remediation (SEAR) which involve the injection of pure water or water with hydrocarbon mitigation agents or specialty surfactants into the porous bed to elute petroleum products sometimes in the form of oils with high viscosity.

The spread of organic compounds in the soil takes place in several stages. The first step involves the movement of the oil phase in the unsaturated zone. Such migration of hydrocarbons is a multiphase flow. In the presence of air in soil, and under the influence of gravity, there is a simultaneous movement of hydrocarbons and water in pores. Petroleum substances reach the groundwater capillary zone and form an impregnation layer when their concentration exceeds the retention capacity of soil. Then mobile hydrocarbons in the form of contrails spread horizontally in the pore capillary zone. Spreading surface of oil in the ground is limited by its mass and capillary forces. Along with changes in the groundwater table oil substances may move up or down. In this zone stagnant layer may occur, which is located below the groundwater table.

Investigation of the kinetics of elution of viscous oils from the ground layers is a very important factor for predicting the efficiency of the remediation processes. Usually, despite many techniques developed in the past, the washing out of petroleum substances in the natural environment occurs under the influence of pure water as the washing out solvent and the gravity as the driving force.

Porosity is one of the main parameters characterizing porous or granular beds. The presence of oil in such structure causes their full or partial saturation and one can say that from the viewpoint of flow the real porosity is very low or equal to zero. During elution processes – water flow through the contaminated bed with an oil – more and more of saturating substances are washed out. The result is that the actual porosity increases eventually reaching the value of the dry bed porosity, which means porosity saturated only with an air. It follows from this that the porosity of the bed is dependent on time and therefore we are dealing with flows through the bed of a resistance which changes during the process.

Changes in porosity during the time can also be seen in processes of freezing and thawing of soil, where free spaces may be blocked by lingering ice. The problem was presented in (Bear J. 1993, Derski W. 1964, Derski W., 1965, Seyfried M.S. and Murdock M.D. 1997). Also, natural processes such as consolidation and compaction of soil lead to changes in porosity. Another example of permeability changing with time, and thus the actual porosity may be the blood flow through small veins in the case of a person suffering from arteriosclerosis. However, in this case porosity of the system decreases with time (Wojnar R., 2010).

The paper deals with the problem of gravitational elution of an oil from the tank open at the bottom. Two aspects of this process were investigated. The first one concerned the hydrodynamics of gravitational flow of water as the eluent through the granular bed saturated with a liquid of high viscosity. The second one regarded the kinetics of a removal of the oil from the porous, granular bed during the elution. Such problems are not well described in the literature from the point of view of process engineering.

2. EXPERIMENTAL WORK

Investigations of the elution of oil from the granular bed were performed using apparatus whose scheme is presented in Fig. 1. It consisted of an experimental column made of a glass tube (1) with

internal diameter of 0.09m and a length of 0.55m. Granular material layer (3) of the height $H=0.2\text{m}$ was secured at the top and bottom with layers of mesh and foam of very high permeability (2) to prevent a distortion of the bed during the pouring of liquid. Electronic balance (5) was placed under the apparatus to allow continuous tracking of the seepage processes. The initial height h of the eluent in the tube was 0.35 m. Changes of the h value with time were measured using the linear scale (6).

Yellow sand was used in the experiments as the granular bed. Material was air dried for several days before the experiments. Sieve analysis allowed to obtain several fractions of the material. In the experiments two fractions were used. One with the grain size from 250 to 400 μm and the second one with a grain size from 400 to 630 μm . Porosity of the air only saturated beds was calculated using the values of the bulk density measured experimentally and the density of quartz equal to 2650 kg/m^3 . Standard formula in the form given by Equation (1) was used and results are presented in the Table 1.

$$\varepsilon_d = 1 - \frac{\rho_b}{\rho_s} \quad (1)$$

where:

- ε_d - porosity of the bed saturated only by air, dry bed, [-]
- ρ_b - bulk density, [kg/m^3]
- ρ_s - solid material density, [kg/m^3]

The values of an average diameter for each fraction were calculated as an arithmetic mean using Equation 2 – results are also presented in Table 1.

$$d_a = \frac{d_l + d_u}{2} \quad (2)$$

where:

- d_l - mesh size of the lower sieve
- d_u - mesh size of the upper sieve

Table 1. Porosity of air saturated bed

Fraction of the sand [μm]	Solid material density [kg/m^3]	Bulk material density [kg/m^3]	Average diameter d_a [μm]	Dry bed porosity ε_b
250 ÷ 400	2650	1730	325	0.347
400 ÷ 630	2650	1690	515	0.362

Elution experiments concerned the washing out of the oil from the bed of sand using water as the eluent. Samples of sand were mixed very carefully with an appropriate amount of oil. Sunflower oil was used for this purpose as a model liquid of the appropriate high viscosity. Its density was equal to 925 kg/m^3 and the viscosity was equal to 72 mPas.

Experiments were performed according to the following procedure. A layer of sand was placed in the glass tube and protected with the steel mesh and foam. An appropriate amount of water was poured cautiously over the sand and changes of the level in the tube above sand during the permeation as a function of time were recorded. Every time the same method of filling the tube with sand was applied ensuring that the structure of the bed was very similar during every test. This was confirmed repeating experiments three times for the dry bed and in some cases for the bed mixed with an oil. Acceptable repeatability of the results was obtained.

The second set of experiments concerned the kinetics of the elution process. Samples of oil – water mixture were collected at the discharge of the column with the granular bed at the times corresponding every five centimeters of the lowering liquid level. These mixtures were emulsified using a

homogenizer with an addition of the emulsifying agent Rokacet 07. The concentration of oil in the samples was measured using Turbiscan turbidimeter provided by LabSoft company. The calibration procedure allowed to convert the recorded values of the amount of the scattered light from the instrument into the concentration of the oil. The methodology described above is very efficient and safe and it seems that until now it has not been applied in investigations of this type.

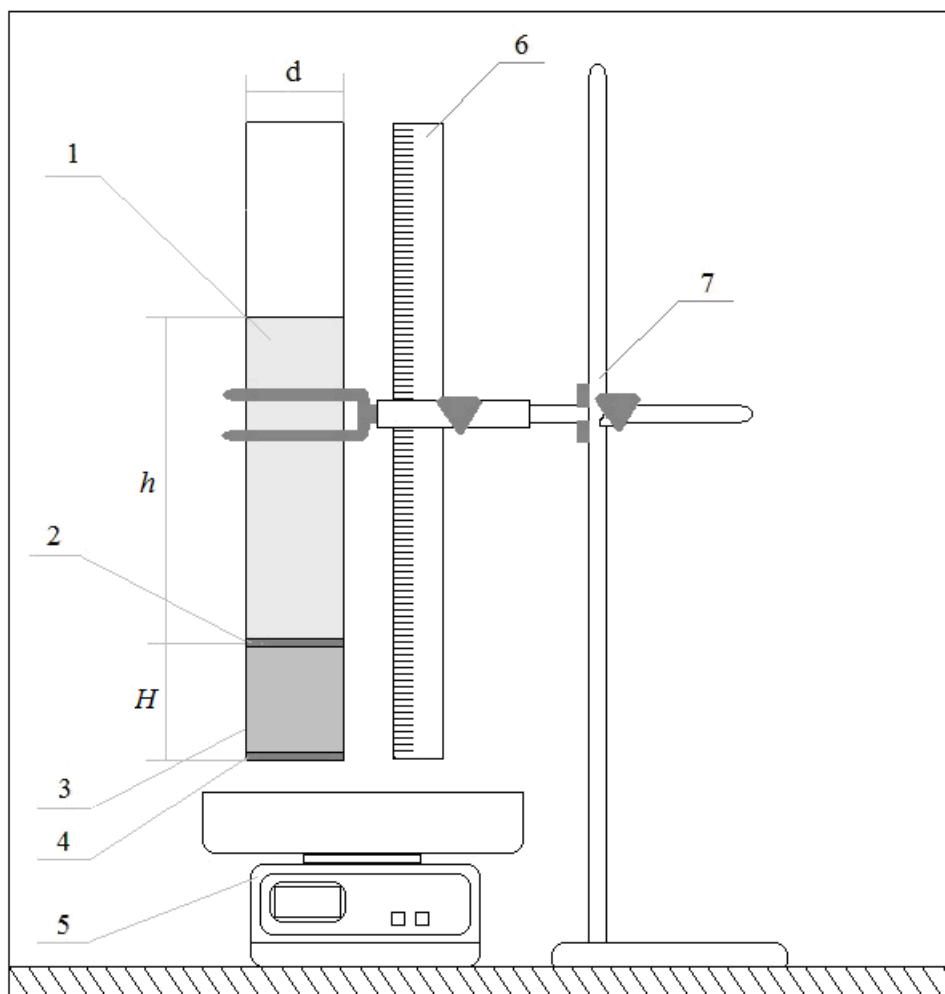

Fig. 1. A schematic view of the experimental apparatus:

1 - glass tube, 2 and 4 - mesh and sponge, 3 – granular bed, 5 – electronic balance, 6 – linear scale, 7 - stand. H - the height of the porous layer, h – the height of the layer of an eluent

3. HYDRODYNAMICS OF ELUTION

During the experiments oil was removed from sand by water. The recorded values of the level of the eluent are presented as the function of time in Fig. 2 and 3. Also dependences of $h = f(t)$ obtained for the dry bed are shown in these figures.

The graphs in Figs 2 and 3 show that the presence of oil in the granular bed substantially affects the speed of seepage of liquid through the solid structure. It may be noted that the final times of water seepage through the bed containing no oil are shortest. These times grow proportionally with the increasing amount of oil in the bed. From the slope of these curves one can deduce velocities of the flow. It can be concluded that they are the highest when there is no oil in the bed and they decrease with the increasing content of that oil. In the case of curves corresponding to the oil content, seepage rate is initially small and grows over time. This may be caused by an increase in the permeability of the bed due to the gradual elution of oil.

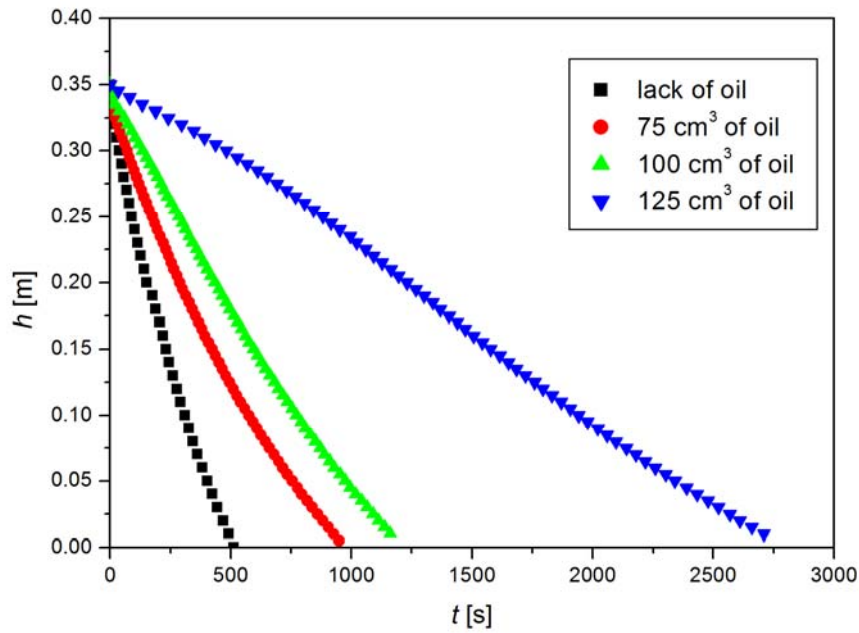

Fig. 2. The dependences $h=f(t)$ for the elution of oil from the granular bed; sand, fraction 250 ÷ 400 μm

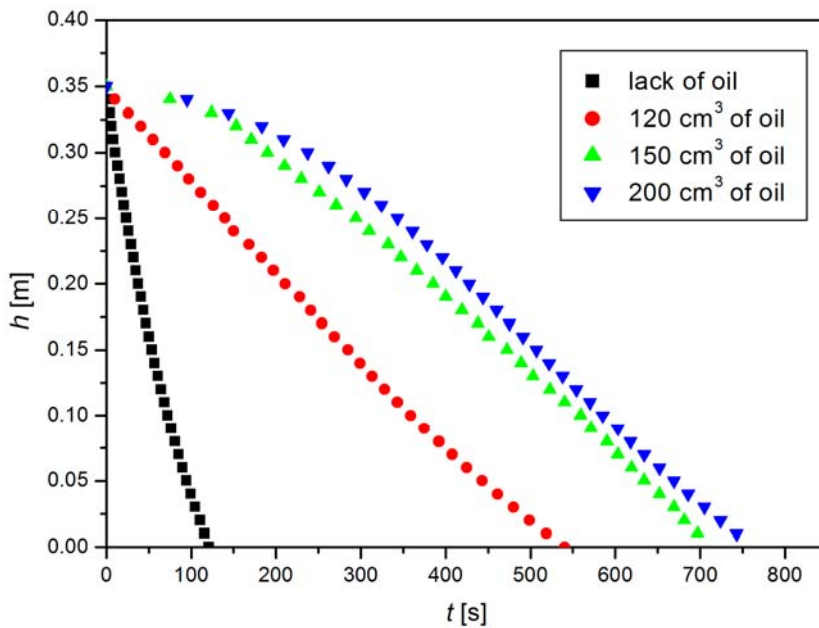

Fig. 3. The dependences $h=f(t)$ for the elution of oil from the granular bed; sand, fraction 400 ÷ 630 μm

It may be also noted that the shapes of curves are different depending on the amount of oil in the bed. When the flow occurs through the bed without oil one can notice that the $h=f(t)$ curves have a concave shape. These curves become gradually straight and even convex. Such changes in the shape of the curves are the result of the initial resistance to flow through the bed. This resistance is growing with an increase of oil volume. The second factor affecting the shape of the elution curves is the kinetics of the removal oil from the bed of sand.

Processes of the flow through porous media are generally characterized using Darcy's law given by the formula (Bear J., Verruijja A., 1987, Strzelecki T. et. al., 2008)

$$v = \frac{Q}{S} = k \frac{h}{l} \quad (3)$$

where:

- Q - a liquid flow rate [m^3/s]
- S - a area of the cross section of the bed, [m^2]
- h - a height of the water above the bed or the a pressure drop along the bed [m]
- l - height of the bed, [m]
- k - permeability of the bed [m/s]

Permeability of the bed k is used as the constant parameter typical for a given kind of ground, soil or another type of porous material.

Darcy's law is a formula which is based on the assumption that flow through the bed is laminar and therefore the flow rate and the pressure drop are directly proportional. It seems that in the situation when gravitational flows occur in beds of high porosity such condition is not necessary fulfilled.

The character of flow in granular beds can be predicted on the basis of values of the Reynolds number calculated using the following formula

$$\text{Re} = \frac{v d_a \rho_w}{\eta_w} \quad (4)$$

where:

- ρ_w - density of a liquid, [kg/m^3]
- η_w - viscosity of a liquid. [Pas]

Data presented in Fig. 2 and 3 allow to calculate the apparent velocities of the liquid migrating through the granular structure. Assuming that it is mainly water with density about $1000 \text{ kg}/\text{m}^3$ and viscosity 0.001 Pas one can calculate, using the Equation (4), the values of the Reynolds number. The results are presented in Fig. 4 – Re as the function of the height of the liquid above the bed.

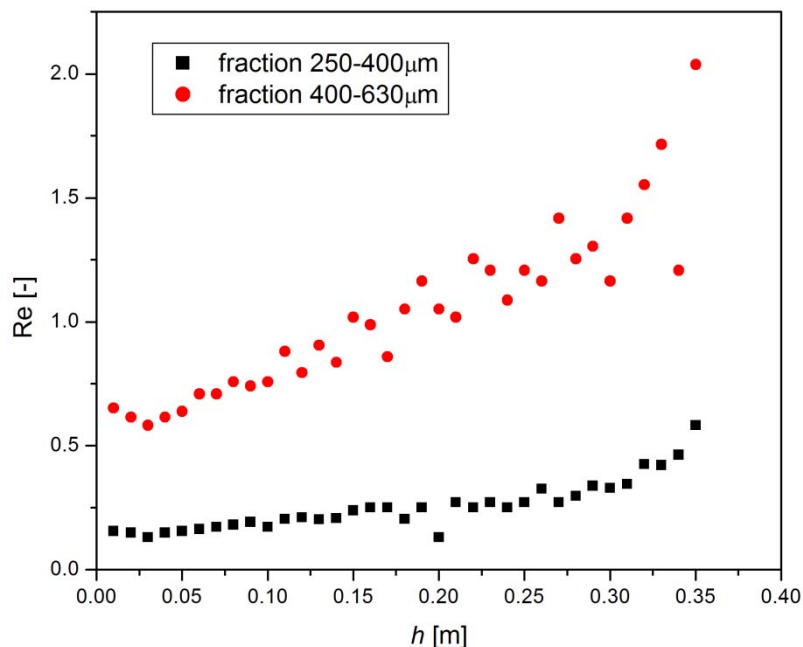

Fig. 4. The dependence of the Re number on the height of the liquid; pure sand

It is generally assumed that flows in granular media preserve their laminar character when values of the Re number are lower than one or ten depending on the source of the literature. One can find in Fig. 4 that the calculated values of the Re number are close to one. Therefore one can think that phenomena characteristic for transitional or turbulent flow are possible in the bed. In such situation the

relation between velocity and pressure drop will not be proportional and the more general concept concerning the rate of flow from the granular bed seems to be necessary. An idea can be proposed here of the replacement of the material constant – bed permeability k with the process parameter. The flow in the bed can be regarded as the flow from the tank with the porous layer at the bottom. The flow velocity from such system can be calculated from the formula

$$v = \varphi \sqrt{2gh} \tag{5}$$

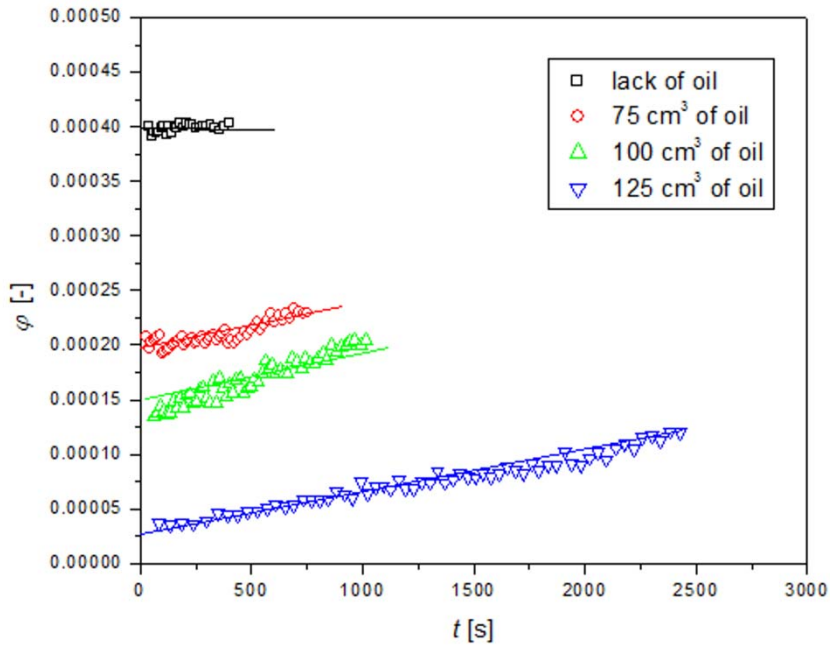

Fig. 5. The dependence of the discharge coefficient on the time of flow; sand, fraction 250 ÷ 400 μm

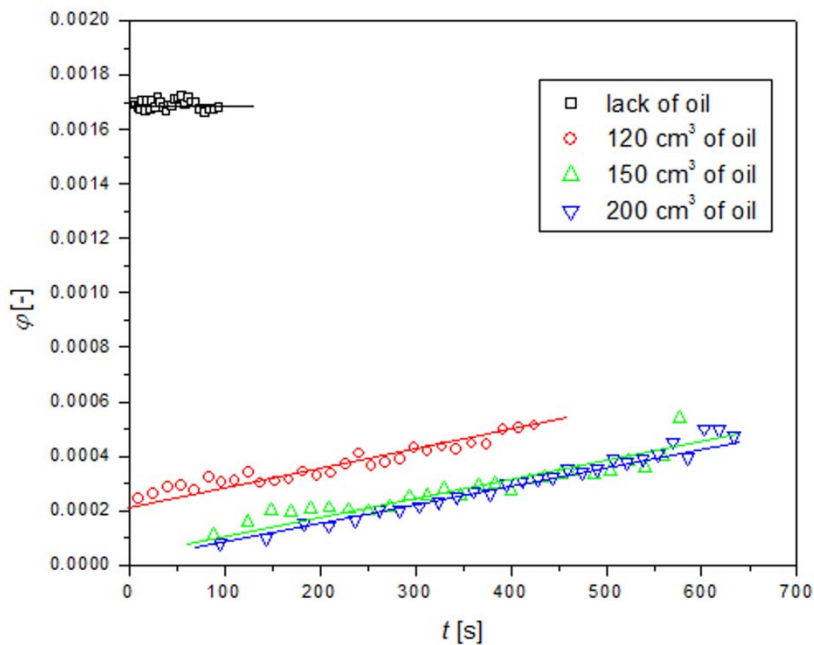

Fig. 6. The dependence of the discharge coefficient on the time of flow; sand, fraction 400 ÷ 630 μm

Parameter φ is known in the literature as the discharge coefficient. It is the process parameter independent of the character of the flow but dependent on the geometry of the opening at the bottom of the tank. Using the calculated values of the velocity v of the decreasing height of the liquid above the

bed and the corresponding values of h the values of φ in Equation (5) have been calculated. In Fig. 5 and 6 the values of the discharge coefficient as the function of time are shown. One can find that the data can be approximated by the linear function

$$\varphi = at + \varphi_0 \quad (6)$$

where a and φ_0 are the parameters of the equation.

The calculated values of the parameters in Equation (6) are presented in Table 2 together with the values of correlation coefficients.

Table 2. Values of a and φ_0

Amount of the oil	a [s ⁻¹]	φ_0 [-]	R ²
Fraction 400 ÷ 630µm			
0	0	0.001718	0.915
120 cm ³	6.167 · 10 ⁻⁷	0.0002254	0.957
150 cm ³	6.209 · 10 ⁻⁷	1.016 · 10 ⁻⁵	0.962
200 cm ³	6.051 · 10 ⁻⁷	7.103 · 10 ⁻⁵	0.983
Fraction 250 ÷ 400µm			
0	0	0.000426	0.906
75 cm ³	5.162 · 10 ⁻⁸	0.000215	0.965
100 cm ³	5.094 · 10 ⁻⁸	0.0001515	0.939
125 cm ³	5.203 · 10 ⁻⁸	2.616 · 10 ⁻⁵	0.988

One can find that for the flow of liquid through the bed without oil the slope of the function $\varphi = f(t)$ is equal to zero. It means that the discharge coefficient has a constant value equal to φ_0 .

4. KINETICS OF ELUTION

The results of the measurements of the concentration of oil in the samples collected at the discharge of the column are presented in Figs. 7 and 8 as the function of the flow time.

It was possible to describe changes of the amount of oil in the samples as the function of the elution time using the following equation

$$C = A \cdot \exp(-k_c t) \quad (7)$$

Formula (7) can be regarded as a kinetic equation of the first order with parameters presented in Table 3 together with the values of the correlation coefficients.

The knowledge of the concentration of oil in the samples allows to calculate the efficiency of elution. For the fraction 250 ÷ 400µm a total of 37.9 cm³ of oil was washed out when the initial amount was equal to 125 cm³. When initially 100 cm³ was in the bed, 19 cm³ was eluted. At 75 cm³ in the bed only 0.28 cm³ was removed. Consequently, a conclusion can be drawn that the process efficiency reached 30.3%, 19% and 0.37% for 125, 100 and 75 cm³ of oil, respectively. For the second fraction 400 ÷ 650µm the amount of eluted oil was equal to 81.38 cm³ for 200 cm³ initially, 80.18 cm³ for 150 cm³ and 29.75 cm³ for 120 cm³ of oil initially in the bed. Hence the efficiency of the process reached 40.69%, 53.45% and 24.75% in the relation to the initial content of oil amounting to 200, 150 and 120 cm³, respectively.

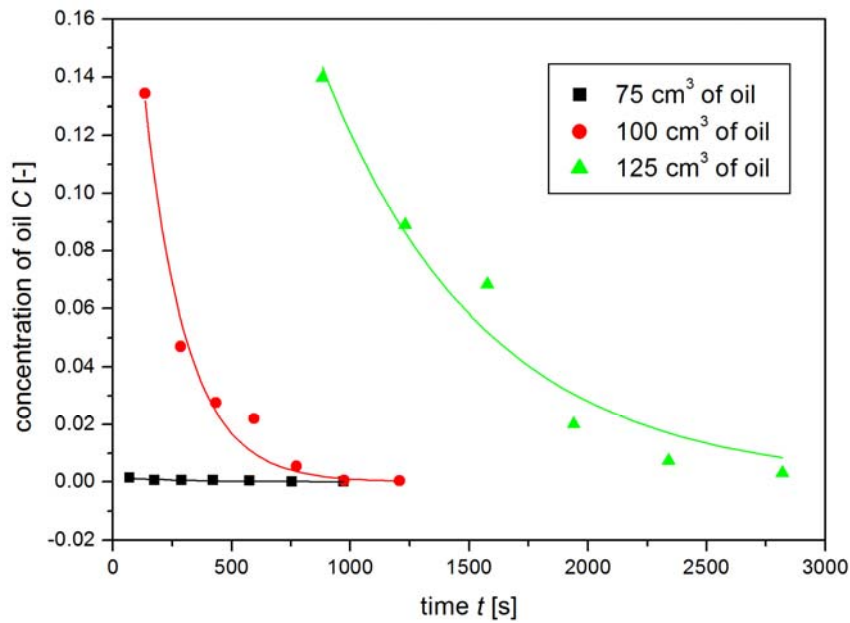

Fig. 7. The dependence of oil concentration in the samples as the function of time, sand, fraction 250 ÷ 400 μm

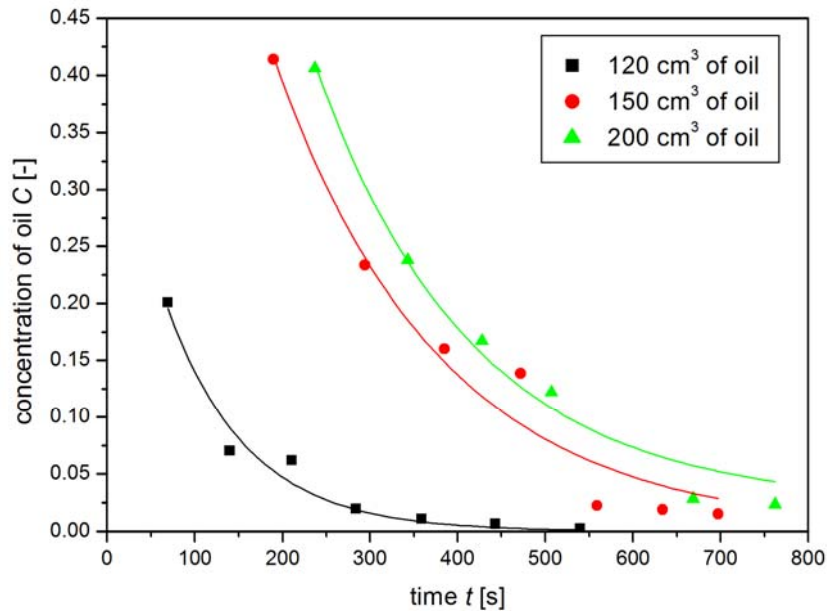

Fig. 8. The dependence of oil concentration in the samples as the function of time; sand, fraction 400 ÷ 630 μm

Table 3. Parameters in the Equation (7)

Amount of the oil	$A [-]$	$k_c [s^{-1}]$	R^2
Fraction 250 ÷ 400μm			
75 cm ³	0.00165	0.00419	0.905
100 cm ³	0.281	0.00562	0.981
125 cm ³	0.521	0.01011	0.964
Fraction 400 ÷ 650μm			
120 cm ³	0.414	0.01085	0.972
150 cm ³	1.17	0.00413	0.968
200 cm ³	1.47	0.00563	0.972

5. CONCLUSIONS

The performed investigations allowed to study from the engineering point of view the phenomena of the elution of liquid possessing high viscosity using the washing out medium of low viscosity. Darcy's law commonly used to study seepage in porous beds was replaced by the concept of the outflow from the tank. At such approach the knowledge of the character of the flow is not necessary. It was found using this idea that the changes of the discharge coefficients are represented by a linear function of the elution time. Also it was possible to describe the kinetics of the washing out process using the first order kinetic equations. The efficiency of the elution process has been also estimated. The results of these investigations can be applied in remediation techniques and for instance in oil recovery from porous structures.

SYMBOLS

A	parameter in the equation (7)
C	oil concentration, -
Q	liquid flow rate, m ³ /s
S	area of the cross section of the bed, m ²
a	parameter in Equation (6)
d_a	average diameter, m
d_i	mesh size of the lower sieve, m
d_u	mesh size of the upper sieve, m
g	gravity acceleration, m/s ²
h	height of the water above the bed or a pressure drop across the bed, m
l	height of the bed, m
k	permeability of the bed, m/s
k_c	parameter of Equation (7)
t	seepage time, s
v	apparent velocity of the flow through the porous bed, m/s

Greek symbols

ε_d	porosity of the bed saturated only by air, dry bed, -
η_w	viscosity of a liquid, Pas
ρ_b	bulk density, kg/m ³
ρ_s	solid material density, kg/m ³
ρ_w	density of a liquid, kg/m ³
φ	discharge coefficient, -
φ_0	parameter of Equation (6)

REFERENCES

- Bear J., 1993. *Dynamic of fluids in porous media*. American Elsevier Publishing Company, INC New York, London, Amsterdam.
- Bear J., Verruij A., 1987. *Modeling groundwater flow and pollution*. D. Reidel Publishing Company, Dordrecht/Boston/Lancaster/Tokyo.
- Derski W., 1964. A method of solving of the system of equations of consolidation theory. *Bull. Pol. Ac.: Tech.* 12, 489-493.
- Derski W., 1965. Equations of the consolidation theory for the case of a source of fluid. *Bull. Pol. Ac.: Tech.* 13, 37-43.

- Izabelska – Mucha D., 2005. Influence of oil pollution on selected geological – engineering properties of clay soils. *Geological Rev.*, 53, 766-769 (in Polish).
- Korzeniowska E., 1997. Evaluation of the oil-contaminated soil in aspect of their usefulness for the purpose of building. *I Conf. Technologies for de-oiling of land, waste, waste water*, PTIE. Gorlice – Wysowa-Zdrój (in Polish).
- Łebkowska M., Muszyński A., Sztompka E., Karwowska E., Miąskiewicz E., 1997. Microbial purification of soil from petroleum-derived ingredients. *I Conf. Technologies for de-oiling of land, waste, waste water*, PTIE. Gorlice – Wysowa-Zdrój, 115 -118 (in Polish).
- Lowe D.F., Oubre C.L, Ward C.H., 1999. *Surfactants and cosolvents for NAPL remediation a technology practices manual*, Lewis Publishers, New York.
- Moldrup P., 1996. Predicting wetting front advance in soils using simple laboratory derived hydraulic parameters. *Water Res.* 30, 1471 – 1477. DOI: 10.1016/0043-1354(95)00277-4.
- Moldrup P., Loll P., 2000. *Soil characterization and polluted soil assessment*, Aalborg University.
- Pastewski S., Hallmann E., Mędrzycka K., 2007. Removal of hydrophobic organic pollutants from soil by surfactants and biosurfactants solutions flushing. *Pol. J. Environ. Stud.*, 16, 386-391.
- Seyfried M.S., Murdock M.D., 1997. Use of air permeability to estimate infiltrability of frozen soil. *J. Hydrology*, 202, 95-107. DOI: 10.1016/S0022-1694(97)00061-9.
- Surygała J., 2000. *Oil pollution in the soil*. Oficyna Wydawnicza Politechniki Wrocławskiej, Wrocław (in Polish).
- Surygała J., 2001. *Crude oil and natural environment*. Oficyna Wydawnicza Politechniki Wrocławskiej, Wrocław (in Polish).
- Strzelecki T., Kostecki St., Żak St., 2008. Modelling of flow through porous media. Dolnośląskie Wydawnictwo Edukacyjne, Wrocław 2008 (in Polish).
- Wojnar R., 2010. Boussinesq equation for flow in an aquifer with time dependent porosity. *Bull. Pol. Ac. Sci.*, 58, 165 - 170.

Received 03 October 2011

Received in revised form 30 November 2011

Accepted 17 December 2011