

A small scale magnetically levitated train for project-based laboratory education

Progression from concept through design and construction to commissioning

GREGOR GLEHN, RÜDIGER APPUNN, KAY HAMEYER

*RWTH Aachen University
Institute of Electrical Machines
Schinkelstraße 4, 52062 Aachen, Germany
tel./fax: +49 241 80 – 97667 / 92270
e-mail: gregor.glehn@iem.rwth-aachen.de*

(Received: 10.09.2015, revised: 20.09.2015)

Abstract: The drive train of a small scale magnetically levitated train reveals the principles of a mechatronic system and offers challenges related to design, construction and control. Therefore, it is used at the Institute of electrical Machines (IEM) of the RWTH Aachen University as a demonstrator for engineering solutions. Instead of being a part of a static predefined student laboratory, the small scale magnetically levitated train is part of dynamic individual student projects. This approach provides the advantage that the students are directly involved in the engineering process and gain motivation out of their personal ideas becoming reality.

Key words: electromagnetic levitation, mechatronics laboratory, linear induction motor, small scale train, education electrical engineering.

1. Introduction

Students should obtain the possibility to strengthen their knowledge through practical experience in order to be better prepared for their working life after graduation. For this, on the one hand engineering students have laboratories at their university or on the other hand internships in the industry. The importance of this practical course content must not be underestimated, because they make up a large part of the allure of engineering. It is usually the case that the laboratories confront all students with the same narrow tasks, for which predefined solutions exist. This usually accounts for a lack in the view of the overall system and the students do not develop a sense of their own solution strategies.

That is why lately more and more project based laboratories are developed. Especially LEGO-mindstorms is very popular for undergraduate students, [1], because of its modularity and plug and play ability. Unfortunately the modularity restricts a deeper understanding of the

overall system and especially the hardware. Only a project that starts from scratch, even offers graduate students the opportunity to fully challenge their creativity.

As a consequence the idea of an individual hands-on student laboratory test bench is born. A drive train, which is composed of different subsystems with mutual dependencies, is chosen as laboratory topic, like in [2]. To encourage the interest for electrical engineering a test bench for a magnetically levitated train with a scale of circa 1:50 provides a playful incentive, [3-5]. The IEM already possesses expertise on magnetically levitated linear drives [6, 7], so that the students can be well supported. It is intended to be used at information events as demonstrator for pupils and visitors, as well as for student mechatronics laboratory.

This test bench is part of a novel approach for student mechatronics laboratory supervision. During an individual project or a final thesis the students are responsible for carrying out the design, construction and operation of the small scale magnetically levitated train. A sustained knowledge in analytical and numerical calculation, manufacturing methods, measurement techniques, rapid control prototyping, electronics and control strategies are necessary to put this idea into practice.

2. Project structure

In the following the tasks for the students to realize the small scale magnetically levitated train are described step by step. All necessary actuators, the attendant power and belonging signal electronics are designed, fabricated, tested and installed by students with the assistance of the institute's mechanical and electrical workshop. The design and construction of the test-bench is largely completed, as can be seen in Figure 1.

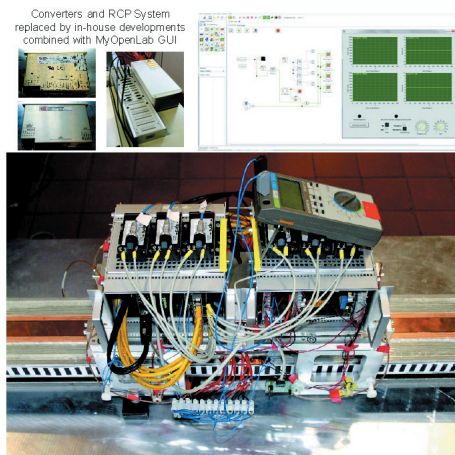

Fig. 1. Progress of small scale magnetically levitated train

Main emphasis is laid on the accomplished milestones achieved by the students, which are summarized in table 1.

Table 1. Timetable of accomplished milestones

Year	Milestone
2009	Basic concept
2010	Design and built up of electromagnetic hybrid levitation actuators
2011	Levitation control with Rapid Control Prototyping System
2012	Design and built up of linear induction motor
2013	Propulsion control with Rapid Control Prototyping System
2014	Self-made electronics
2015	(PC-)Interface for test bench
Future	Control implemented on microcontroller

After a safety briefing and admission to all tools the students are allowed to freely access the laboratories for unattended work and test bench operation. The mechatronics laboratory assignments are laid out, so that the students are able to work simultaneous on different subsystems, more precisely the levitation and propulsion system including the control strategies as well as the associated power and signal electronics. Nevertheless, all subsystems need to meet the pre-defined specifications. The technical data of all subsystems is listed later on.

2.1. Basic structure

At the beginning it started with a general study about the basic concept. The specifications are determined and suitable technology topological are chosen. The dimensions of the magnetically levitated train are set to a scale of circa 1:50. The outcome of that are the dimensions of the train's chassis:

$$\circ \text{Width} = 500 \quad \circ \text{Height} = 250 \quad \circ \text{Depth} = 150 \text{ mm.}$$

The train's chassis is made of aluminum and contains the levitation and propulsion system as well as all electronics. The weight of the train's chassis including load is assumed to be below 20 kg to restrict to necessary levitation force. The propulsion force is not settled, but because of mutual coupling it also depends on levitation force. The arbitrary length of the track is set to 2.8 m to fit on the base plate of the test bench. The track is made of bulk iron with a thin copper plate on top and serves as back iron yoke for the levitation and propulsion system, and for the latter also as short circuit plate. Figure 2 shows the computer aided design model of the train and rail without the electronics next to the built up device.

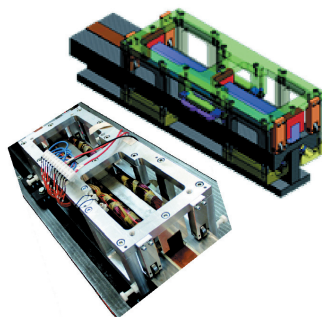

Fig. 2. CAD model and realization of track, chassis and actuators

The linear induction machine of the propulsion system and the hybrid-magnet actuators of the electromagnetic levitation system are discussed together with the electronics in the following subsections.

2.2. Levitation system

The levitation force is provided by electromagnetic levitation actuators. Four actuators are on bottom of the train beneath the track, two in a 45° angle at each side. For this reason the guiding and lifting are coupled. Two additional actuators are on top of the train, one in the middle at each side. Figure 3 shows the topology of the levitation actuators.

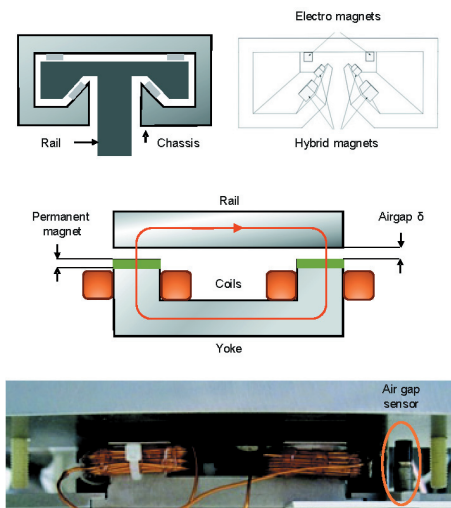

Fig. 3. Levitation actuators

The actuators are U-shaped hybrid magnets, which combine a permanent magnet with an electromagnet, and utilize the track as back yoke. The attraction force caused by the permanent magnets should neutralize the gravitational force at stand still and rated air gap. The attraction force of the electromagnet is adjusted by the amplitude and the polarity of the supplied current. The actuators attraction force as a function of current supply and air gap is calculated analytically with magnetic equivalent circuits and numerically with finite element method. The attraction forces of the actuators are proportional to the square of the current and the inverse square of the air gap as Equation (1) shows.

$$F_{att} = \frac{A_{\delta}}{2\mu_0} \left(\underbrace{\frac{\mu_0 \mu_{rPM} \Theta}{2(h_{PM} + \mu_{rPM} \delta)}}_{Coil} + \underbrace{\frac{B_r h_{PM}}{(h_{PM} + \mu_{rPM} \delta)}}_{PM} \right). \quad (1)$$

Hence, both the current and the air gap needs to be measured. The local air gaps are measured at each actuator with an analog high frequency eddy-current distance meter. The currents are measured at each full bridge converter with an analog current measuring transformer.

The electromagnetic hybrid actuators only produce an attraction force between the train and the track and thus an active control is necessary. The air gap control needs to keep the train stable in five degrees of freedom. Two different air gap control strategies are implemented. An independent control of each air gap and a degree of freedom control with global positioning.

The single air gap control is tested at a special single actor test bench with self-made power and signal electronics. Figure 4 shows the block diagram of a hardware in the loop simulation of the implemented controllers.

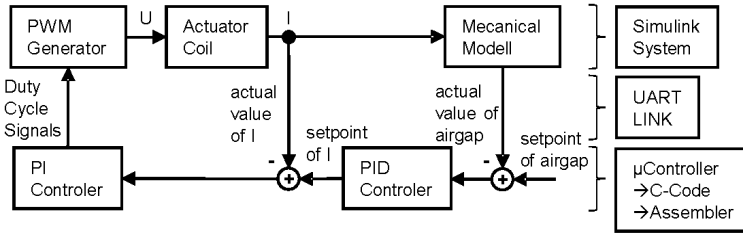

Fig. 4. Block diagram of hardware in the loop simulation

The degree of freedom control is tested on the whole train with commercial converters and a dSpace rapid control prototyping interface. The aim is to achieve the degree of freedom control with self-made electronics, with single air gap control for whole train as staging post. This applies in particular to ensure the real-time capability of the control strategy on the microcontroller.

2.3. Propulsion system

In this section the topology of the linear drive is introduced. A linear induction motor is chosen, because of its simple, robust and cheap construction. However, disadvantages arise in operation, in the form of a strong attraction forces between the drive and rail, which interact with the levitation and complicates the control scheme.

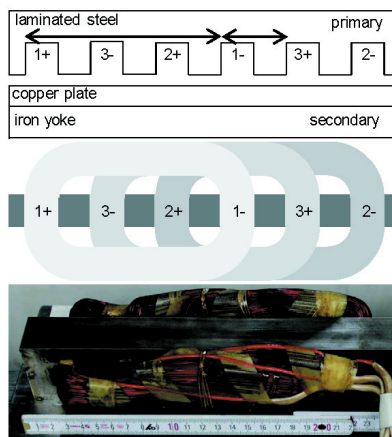

Fig. 5. Linear induction motor topology

The short primary is composed from laminated steel sheets and mounted in the train chassis. It bears a three phase system, which three winding phases are not chorded or distributed over slots. The two pole pairs of the machine are connected in series. The long secondary is a short circuit copper plate at top of the track and the track itself as back yoke. Figure 5 shows the topology of the linear induction motor.

The electromagnetic specifications are determined analytically and the design is developed with parametric finite element simulations. The redraft of the drive is first done analytically with an estimation of the thrust analog to the tangential force of a rotary induction motor. Based on the dimensions of the rough calculation a parametric design study is done. The strong partial differential equation for the magnetic vector potential at quasi static problems, see equation (2), is solved with several implementations of the finite element method. Taking into account the dependencies of the magnetic field of time and movement constitutes a special challenge.

$$\nabla \times \underbrace{\begin{pmatrix} v \nabla \times \mathbf{A} \\ \mathbf{B} \\ \mathbf{H} \end{pmatrix}}_{\mathbf{J}} = \sigma \underbrace{\begin{pmatrix} \text{dynamic} \\ \text{static} \\ -\nabla \phi - \frac{\partial \mathbf{A}}{\partial t} \\ \mathbf{E} \end{pmatrix}}_{\mathbf{J}} \quad (2)$$

The performance characteristic of the drive is depicted by an electrical circuit diagram with lumped parameters, which is derived from common rotary machine models with integrated linear dependencies, see Figure 6. With that the performance characteristic is predictable with a circuit simulation. The necessary lumped parameters can either be measured a posteriori or extracted a priori out of the electromagnetic finite element simulations.

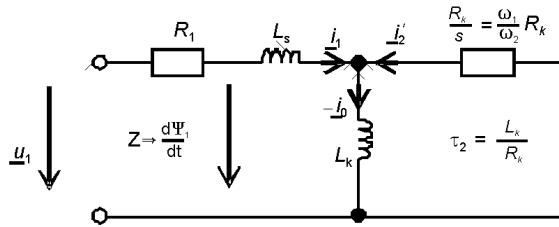

Fig. 6. Linear induction motor circuit diagram

The voltage equation used in time harmonic domain is shown in (3).

$$u_1 = i_1 \mathbf{Z} = R_1 i_1 + \frac{d}{dt} \Psi_1 = R_1 i_1 + \underbrace{j\omega_1 \left(L_s + L_k \frac{1}{1 + j\omega_2 \tau_2} \right)}_{\Psi_1 = Li} i_1 \quad (3)$$

The used equation for the thrust is shown in (4).

$$F_{mec} = \frac{P_{mec}}{v_{mec}} = \frac{p R_2 i_2^2}{2 \tau_{pp} (f_1 - f_2)} = 3 R_2 i_1^2 \frac{1}{\omega_2} \frac{\pi}{\tau_{pp}} \frac{(\omega_2 \tau_2)^2}{1 + (\omega_2 \tau_2)^2} \quad (4)$$

Two different control schemes are analyzed, the open loop Amplitude/Frequency control and the closed loop field oriented control. The open loop control is tested with both rapid control interface including commercial converter and self-made signal and power electronics. The field oriented control is only implemented in Matlab/ Simulink and not yet in operation at the test bench. A closed loop control requires the measurement and feedback of one of the transitory values of acceleration, speed, position. Therefore a linear optical incremental encoder is developed. The acceleration is subject to too much interference and the position is useless for arbitrary linear track.

2.4. Signal and power electronics

Figure 7 shows the housing of the power supply and all electronics, which is mounted on top of the train's chassis. Before the self-made signal and power electronics were ready to use, they were substituted by a dSpace DS1103 PPC Controller Board and CopleyControls converters, in particular one 3-phase inverter Mod. No. 7225X1 and six full bridges Mod. No. 422CE. Additionally a switched-mode power supplies were used.

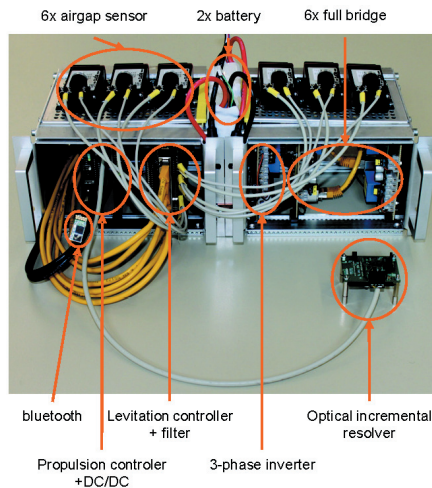

Fig. 7. Housing of power supply and electronics

Figure 8 shows the self-made electronics for the levitation and propulsion system. For signal processing two microcontrollers are used. On the one hand a dsPIC30F4013 with PWM generator TLC5940 is used for the levitation and on the other hand a dsPIC30F2012 for propulsion. To measure the speed of the train, an optical linear encoder has been built out of several individual VCNL4020 sensors from Vshay company. The microcontroller used for propulsion also provides communication via a Bluetooth module with UART interface to a PC. Through a MyOpenLab GUI control signals can be sent and measured signals can be received. Also the propulsion and levitation microcontrollers exchange signals via UART. Analog measuring signals requires noise filter and signal conditioner. For the voltages which are proportional to the measured air gaps even an independent board has been developed.

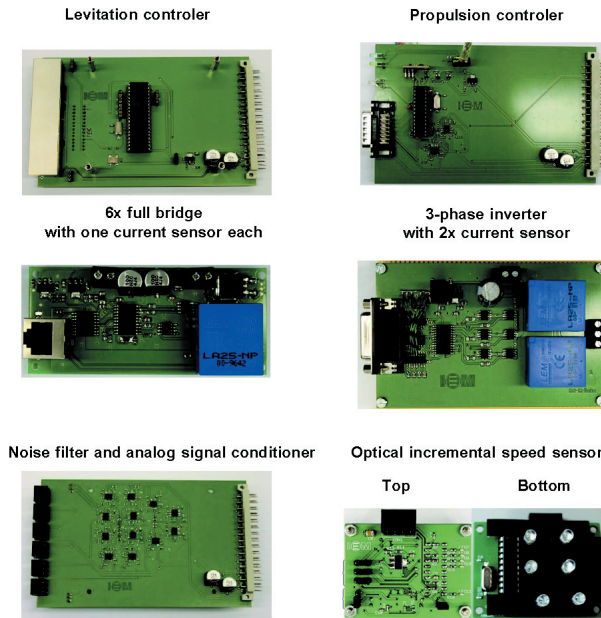

Fig. 8. In-house developed electronic systems

Table 2 shows the specifications of the used power electronics. Particularly successful is the reduction of weight by a factor of 7 and beyond a reduction in losses at rated operation by a factor of 10.

Table 2. Specifications of used three phase inverters

Specification	Copley Controls 7225X1	Three-phase inverter student design	Copley Controls 422CE	Full bridge student design
Input Voltage	24-180 V	15-45 V	24-180 V	15-45 V
Rated Current	10 A	12 A	10 A	8 A
Peak Current	25 A	97 A	20 A	108 A
Weight	680 g	102 g	357 g	52 g

The train is now powered by two rechargeable lithium-ion battery packs with 18.5 V 4400 mA/h, connected in series. The battery voltage is load dependent and differs in a range of 32-42 V. Several DC/DC converter provide different voltage levels for the applied electronics. The air gap sensors require 30 V. The current sensor and the operational amplifier require 15 V. The microcontroller and the optocoupler require 5 V. The low maximum voltage level considerable reduces the risk of injury. Possible short circuit currents are restricted by a fusible cut-out. Possible overvoltage can be intercepted with zener diodes. This is also the reason that the students are allowed to work unattended. The sensors and signal electronics already consume 40 W in idle mode. The power consumption of the entire electronics in nominal operation is more than ten times higher.

2.5. Future tasks

Although the design and construction of the proposed components is finished, we would like to start with their revision. New projects could emerge from the development of self-built electronics for measuring the position of the drive or the air gaps. A technical documentation of the entire system has to be written. However, the focus clearly shifts from the hardware to the software. Particularly the control and interface offer numerous software projects.

The next important steps are to put all subsystems into operation and making them operable via an interface. In addition to the functions that are already available, like basic operation of propulsion and levitation system, more sophisticated options should be available, like specifying a drive cycle or display measurements in real-time.

Beside that the control parameters of the propulsion and levitation system needs to be tuned. New control mechanisms, like sensor-less-control, are applicable. Several control strategies can be compared. Also permanently recurring projects, such as the re-implementation of control schemes and the adaption of their parameters, are also conceivable.

3. Evaluation of education achievements

This section evaluates the educational success of the project. It is underlined what the students have learned and achieved while dealing with the different parts of the project. The students have to work problem-oriented to deal with such an outgrowing complex system. Despite the freedom in the solution approach, the students have to meet specifications. They have to work conscientious, to take all mutual dependencies into account and guarantee a later smooth operation.

3.1. Modelling and measurements

The students derived several kind of models for each sub-system, by using different approaches and level of detail. The students learned about features of engineering design software. For instance, the electromagnetic designs of the levitation actuators and the drive are not only evaluated analytically but also calculated numerically with multiple tools like the institute's in-house finite element package iMOOSE [www.iem.rwth-aachen.de], the open source finite element package FEMM, and the commercial software Ansys.

Matlab / Simulink is applied for modeling and comparison of several control strategies. Moreover, the microelectronic circuit boards are designed in Eagle, programmed in MicroProg with language C and simulated in Falstad circuit simulator or Spice.

In addition, especially the measurement of previously simulated forces is important. For both the levitation and the propulsion individual test setups are created. The levitation force over applied current at constant air gap of each hybrid actuator is checked, the results are shown in Figure 9. The combined force of all actuators best meets the requirements at 1 mm air gap. Figure 10 contains the locked-train thrust with an open-loop control of current and frequency at rated current of 10 A. The Thrust is measured with the device HBM Z6FD 1/10 kg. The measured values show a good agreement with the simulations at higher frequency. The deviation at low frequencies is probably based on the idealization of the finite element simulation, such as neglect of friction.

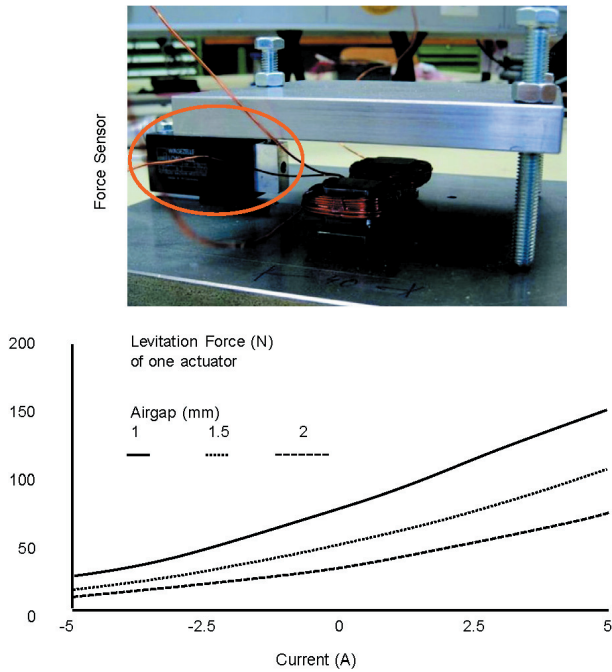

Fig. 9. Levitation force test bench

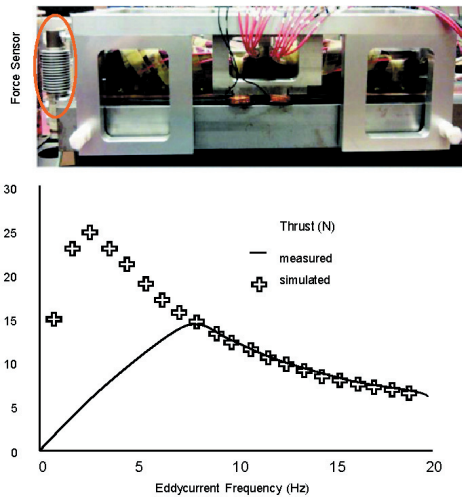

Fig. 10. Thrust test bench

During operation many values have to be measured and evaluated. Table 2 contains the measured quantities and the attendant instruments. Not only electrical values such as current and voltage over frequency are recorded, but also mechanical quantities such as force, acceleration, speed, and air gaps. The students must be able to evaluate the measurements based on

their previous calculations and simulations. Most quantities can be directly measured with multimeters or oscilloscopes. The challenge is to gather all quantities measured with special instruments and integrate them into a unified interface. For this purpose the students initially utilized the rapid control prototyping system dSpace with its interface ControlDesk, which is ultimately replaced by a self-made microcontroller board with MyOpenLab as interface.

Table 2. Measured quantities

Quantity	Measurement device
Current	LEM-Wandler LA 25-NP
Airgap	EPRO PR6423
Acceleration	Freescale MMA 8452Q
Speed	incremental resolver – student design

3.2. Survey

In order to evaluate the project a survey is created which collects the feedback of the participating students. The survey contains over thirty questions that concerns subjects like the concept, the supervision, the organization and personal impressions. In the following, the results of the survey are briefly summarized:

- Concept

The students evaluate the concept of the projects positive. More specific, they found the offered topics interesting and the requirements transparent. The project is structured and remains free of shape. The students possesses the necessary basic knowledge to solve the tasks and meanwhile acquire advanced knowledge.

- Supervision

The supervisor is well rated, too. He is easy to contact, gives useful feedback and responds to comprehensive questions. The projects give the supervisor the opportunity to teach the education content with enthusiasm and therefore motivate the students to introduce their own ideas.

- Organization

The participants of group projects are only master students, but beyond that the train is content of several Bachelor and Master Theses. The elaborations of previous project groups were perceived by the following project groups as helpful. The laboratory workplaces are adequate for independent work. The students have learned to organize themselves and to share their workload. A group size of up to four participants seems to be reasonable. The estimated working time is appropriate for the workload. Most groups spread the workload over the entire semester.

- Personal impression

In most cases the motivation to participate is either interest in the particular student projects topics or a general interest in the institute's topics. The individual projects receive a positive evaluation. The students learned to present their ideas, to hold professional discussions and to document their results. Technical and comprehensive skills have evolved and skills in scientific work expanded. It is particularly pleasing that participating students have consistently fun, they feel a strengthening of their team spirit and like to continue in a similar field of activity. They would re-elect the project against another laboratory and recommend it to their fellow students.

- Suggestion for improvement

Especially in the development of electronics, the students would have liked more support in advance to minimize the number of subsequent revisions. The systems are not always protected from misuse, so that an error in the interconnection sometimes requires time-consuming repairs. Ordering times have occasionally considerably delayed the intended time schedule, so in the future more parts are kept in stock. The used tool chain is not user-friendly because of its diversity of applications. Some functions are insufficiently documented or still missing. A better documentation and more functions will be part of future projects. But the number of utilized tools will be maintained, so that the students learn how to use them.

4. Conclusions

The students achieved to understand and independently develop a complex mechatronic system. The analysis of the survey shows that the students enjoyed their individual projects and therefore gained much motivation. Thus the students have learned to confidently use their knowledge for engineering tasks. The small scale magnetically levitated train project still grants more possibilities for further individual student laboratories.

References

- [1] Behrens A., Atorf L., Schwann R. et al., *Matlab meets lego mindstorms – a freshman introduction course into practical engineering*. IEEE Transactions on Education 53: 306-317 (2010).
- [2] Chu R. H., Lu D.-C., Sathiakumar S., *Projectbased lab teaching for power electronics and drives*. IEEE Transactions on Education 51: 108-113 (2008).
- [3] Appunn R., Herold T., Hameyer K., *Development of a small scale magnetically levitated train as demonstrator for undergraduate mechatronics students*. Proc. Int. Conf. Optimization of Electrical and Electronic Equipment, pp. 1295-1300, (2012).
- [4] Glehn G., Appunn R., Hameyer K., *Parametric design of a linear induction machine for a small scale magnetically levitated train*. Proc. Int. Conf. Linear Drives for Industry Applications, Hangzhou China (2013).
- [5] Glehn G., Appunn R., Hameyer K., *Small scale magnetically levitated train: A novel approach for the mechatronics laboratory*. Proc. Int. Conf. Linear Drives for Industry Applications, Aachen Germany (2015).
- [6] Schmülling B., Effing O., Hameyer K., *State control of an electromagnetic guiding system for ropeless elevators*. Proc. Int. Conf. Power Electronics and Applications, pp. 1-10 (2007).
- [7] Herold T., Pohlmann A., Hameyer K., *Mathematical description and control design for the simultaneous levitation and propulsion of a conveyor vehicle*. Proc. Int. Electric Machines and Drives Conf., pp. 113-118, (2009).