

M. PAĆKO\*, M. DUKAT\*\*, T. ŚLEBODA\*, M. HOJNY\*

## THE ANALYSIS OF MULTISTAGE DEEP DRAWING OF AA5754 ALUMINUM ALLOY

### ANALIZA WIELOOPERACYJNEGO PROCESU TŁOCZENIA STOPU ALUMINIUM AA5754

This work is focused on the multistage deep drawing of AA5754 aluminum alloy box-type part with flange. Both experimental and numerical analysis were performed in this study to predict causes of contraction and cracking occurring in deformed product in respect to the changes of friction conditions on tool-drawn part contact surface. The numerical simulations were performed using eta/DYNAFORM software and LS-DYNA<sup>®</sup> solver. The research showed, that the results of the simulation are in very good agreement with the results of the real multistage deep drawing processes. Moreover, this study showed, that proper conditions of friction on the tool-drawpiece contact surface is crucial for the correctness of the analyzed deep drawing process. Too large friction can restrict the material flow, particularly along the edge connecting the bottom and side-walls of the drawpiece, causing wrinkling and cracking.

*Keywords:* multistage deep drawing, AA5754 aluminum alloy, finite element method, friction conditions

W ramach niniejszej pracy przeprowadzono komputerową analizę wielooperacyjnego tłoczenia skrzynkowej części z kołnierzem ze stopu aluminium AA5754, z wykorzystaniem oprogramowania Eta/DYNAFORM. Celem badań było komputerowe odwzorowanie rzeczywistego procesu tłoczenia oraz próba określenia przyczyn występowania przewężeń i pęknięć w wyrobie pod kątem zmian warunków tarcia na powierzchni kontaktu narzędzia z materiałem wsadowym. Badania wykazały dużą zgodność wyników symulacji z pomiarami eksperymentalnymi. Badania wykazały również, iż zbyt duże tarcie ogranicza płynięcia materiału wzdłuż krawędzi łączącej dno i ściany wytłoczki, powodując nadmierne przewężanie się lub pękanie materiału.

## 1. Introduction

The structural parts of new cars, meeting the rigorous safety and esthetic requirements, have complicated and very often asymmetrical geometries, what requires the necessity of their production to be performed by means of multistage forming. Such processing route, however, involves high production costs connected mainly with expensive metal forming equipment. Nowadays, a design of complex technologies of metal forming is supported by the use of computer software based on finite element method [1, 6]. The application of such software speeds up and facilitates the design, as well as lowers the expenses connected with the preliminary research and with preparing prototypes.

Deep-drawn products are often used for structural elements in automotive industry. This is why deep draw-

ing is one of the most intensively studied metal forming technologies. Moreover, these products, like for example bodies of cars, are very often important both for the safety considerations and for a visual effect of the final product. They also considerably influence the weight of the final products, so wherever the technological requirements are met, the producers of deep-drawn parts search for the materials replacing steels, such as aluminum alloys. The use of aluminum alloys is more complicated, not only due to the higher overall costs of aluminum itself, but also due to its properties, making deep drawing of these alloys more difficult [5-8].

Considering mentioned above aspects, the use of modern software to simulate multi-stage deep drawing of asymmetrical parts of aluminum alloys sheets, as well as to design complex parts of deep drawing tools, is very important, and is discussed in this work.

\* FACULTY OF METALS ENGINEERING AND INDUSTRIAL COMPUTER SCIENCE, AGH UNIVERSITY OF SCIENCE AND TECHNOLOGY, 30-059 KRAKÓW, 30 MICKIEWICZA STR., POLAND

\*\* SOLIDCAD SP. Z O. O., KRAKÓW, POLAND

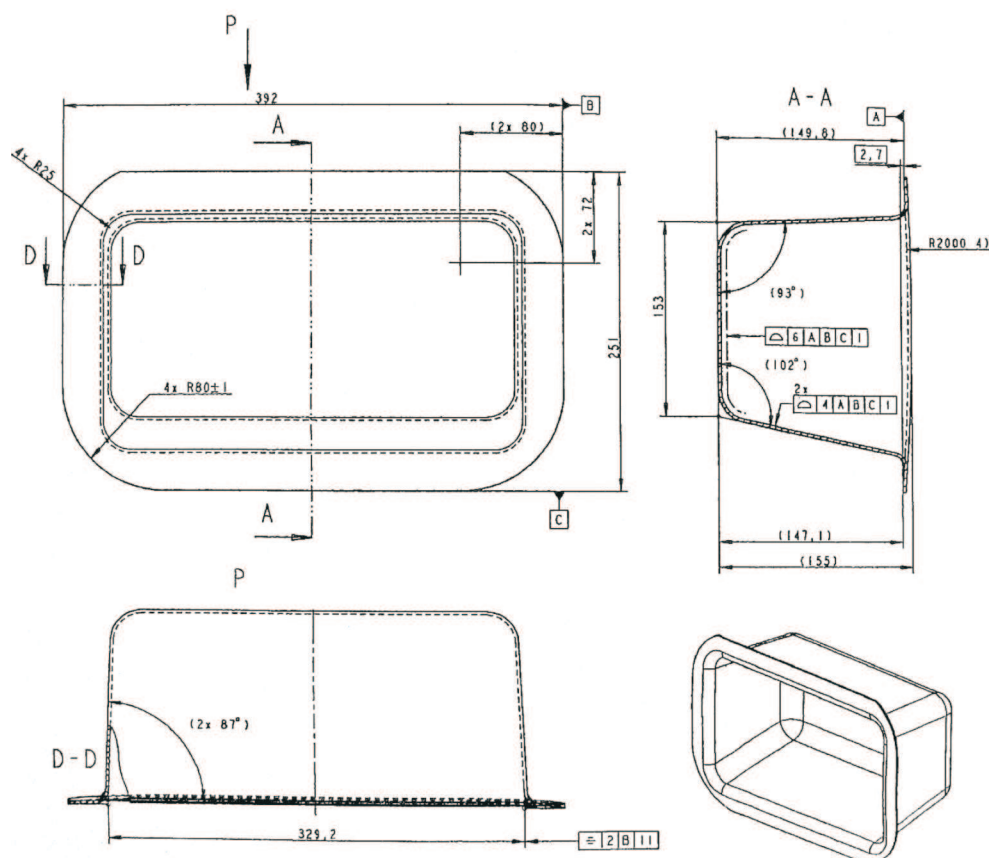

Fig. 1. Geometry of deep drawn material being analysed

## 2. Description of the process and software

**Description of the analyzed forming process.** The analysis of manufacturing of asymmetrical, box-type part made of AA5754 O/H 111 aluminum alloy was the aim of this research. This deep-drawn part was produced by Finnveden Metal Structures for Volvo Trucks. The geometry of this part is shown in Fig. 1.

Manufacturing of this part may be divided into three stages:

- first stage: blanking desired shape from aluminum alloy sheet,
- second stage: multistage deep drawing,
- third stage: cutting the flange off.

Small corner radiuses both on side surfaces and at the bottom of the part, preclude its production in one stage of deep drawing process. Because of this, manufacturing of this part has to be divided into three stages. First stage is deep drawing of flat blank (sheet) with use of blankholder, performed on single-action hydraulic press of a maximum capacity of 240 tons, with use of air cushion. After pre-pressing, double redrawing is performed to reduce corner radiuses and to obtain proper angles of inclination of the side walls. These operations

are performed on single-action hydraulic presses of a maximum capacity of 200 ton.

A blank for the analyzed process is cut off from 2.5 mm thick aluminum alloy sheet. The dimensions of this blank are shown in Fig. 2.

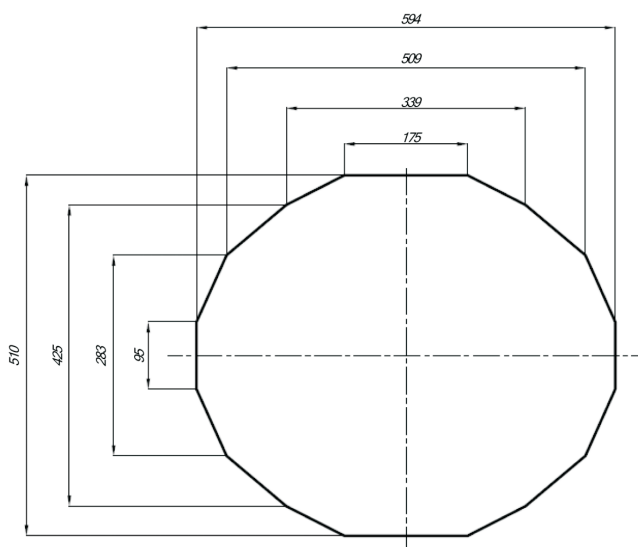

Fig. 2. Geometry of a blank used for deep drawing

Defectiveness of this process is mainly connected with defects occurring during second redrawing of semi-finished product, such as cracks and contraction of the material in the drawpiece corners (see Fig. 3).

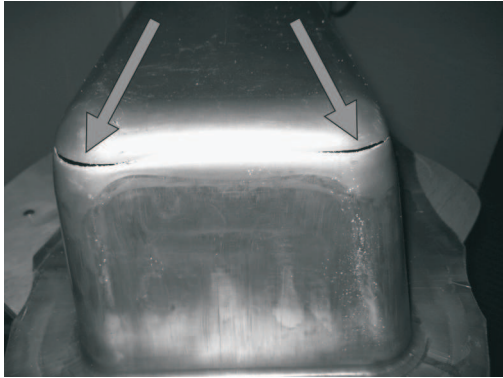

Fig. 3. The areas of contraction and cracking in the analysed draw-piece

**Description of the performed investigation.** The simulation was performed using precise incremental commercial software eta/DYNAFORM based on the explicit dynamic approach. In the finite element simulations, the tooling is considered to be rigid, and the corresponding meshes are used only to define the tooling geometries and are not involved in the deformation calculation. Hence, it is very important to use a sufficiently fine mesh to best represent the tooling geometries. The blank was modeled using the four-node quadrilateral, Belytschko-Tsay element with five integration points through the shell thickness. Contact was modeled using the Coulomb assumption and the condition contact proceeding during stamping was identified by algorithms coded in eta/DYNAFORM system. The real process was modeled by the set of three simulations, each of them being a part of multi-stage deep drawing. Fig. 4 shows the stages of the modeling performed in this research.

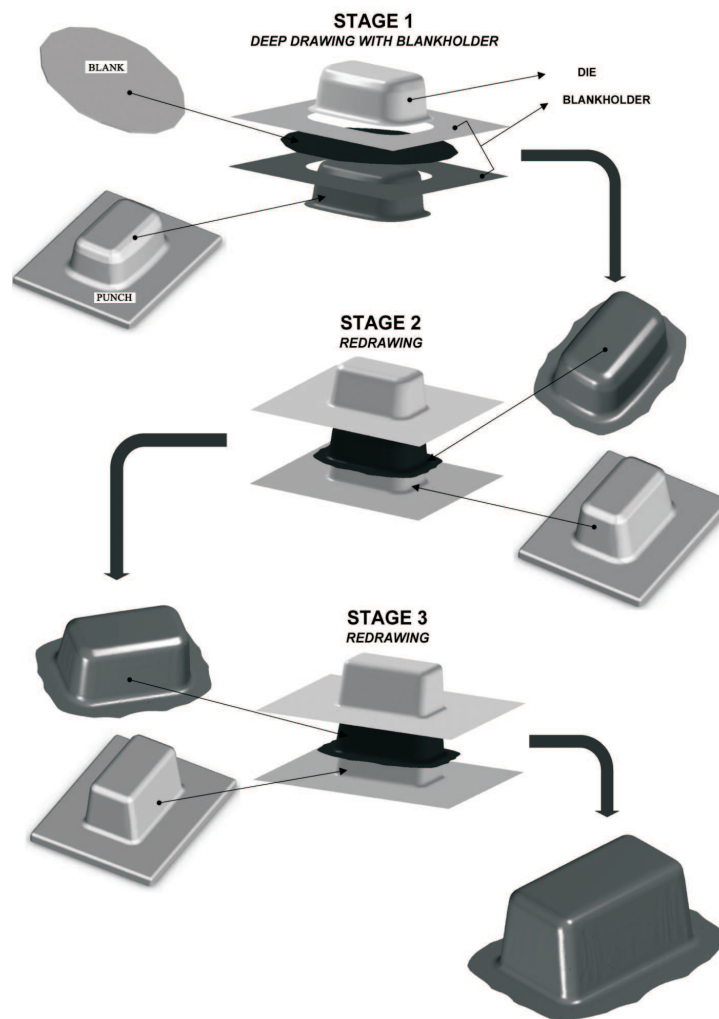

Fig. 4. The stages of the modeling of the analyzed deep drawing process

The files with the data from the given stage of the simulation were imported into the next stage of the simulation, so the properties of the final product were determined by all stages of deep drawing, as it happens during processing in industrial conditions.

The blankholder force ( $F_d = 160$  kN) was determined taking into account thickness to surface ratio of the blank. Unit pressures for aluminum were assumed as  $q = 1$  MPa.

In industrial conditions, a mineral oil is used as lubricant in the first two stages of deep drawing, and a graphite-based grease is used in the third stage. Observations of this process in industrial conditions revealed, that in the third stage of deep drawing the lubricant was not applied correctly. This could result in local increase of the friction coefficient and, in consequence, cause production stops.

To verify assumed thesis of the cause of the material cracking and contraction, several simulations accounting for an increase of the friction coefficient in the third stage of drawing, were performed. The blankholder force and friction parameters used in the simulations are given in Table 1.

TABLE 1  
The simulations parameters used in multi-stage deep drawing

	Simulation			
	A	B	C	D
Stage 1	$F_d = 160$ kN, $\mu = 0.15$			
Stage 2	$\mu = 0, 15$			
Stage 3	$\mu = 0.10$	$\mu = 0.15$	$\mu = 0.20$	$\mu = 0.25$

The AA5754 alloy data – along with its flow curve (Fig. 5) were taken from eta/DYNAFORM software database. A transverse, anisotropic elastic-plastic model

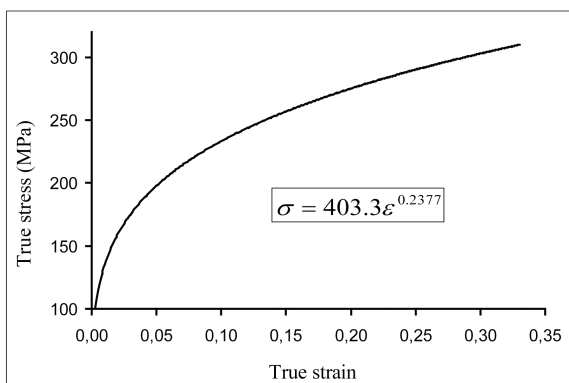

Fig. 5. Flow curve for AA5754 alloy

for the deformed material was assumed in the simulations (No. 37 in the simulation software). Table 2 shows the material data used in the simulations.

TABLE 2  
AA5754 alloy data used in the simulations

Material model: plastic-elastic	
Material: AA5754 alloy	
$\rho$ – density	2.7 g/cm <sup>3</sup>
$E$ – Young's modulus	69 GPa
$\nu$ – Poisson's ratio	0.33
$YS$ – yield stress	101.2 MPa
$R$ – plastic strain ratio	0.77
$n$ – strain hardening coefficient	0.255
$K$ – strength coefficient	403.3

### 3. Results and discussion

**Verification of the correctness of the assumed parameters of simulation.** All the boundary conditions used in the simulations were verified in respect to the conditions of the real process. For this purpose, the analysis of the material thickness in the corners was performed. A schematic representation of the research procedure for obtaining the drawing process parameters is shown in Fig. 6.

In the assumed experimental procedure, three measurements of the material thickness were performed on each of the two symmetrical corners of the drawpiece (Fig. 7 and Fig. 8). The measurements were performed both on the flawless drawpiece and on the drawpiece having visible contractions at the corners. For this purpose, ten points determining a cross-section of drawpiece wall at a given area were defined. Next, the thickness of the material at certain point of the drawpiece was compared with the thickness calculated during simulation, what allowed obtaining material thickness distribution along the cross-section of a corner of drawpiece. Such performed test of the consistency of simulation parameters with the parameters of real deep drawing allowed obtaining results shown in Figures 7 and 8. Thickness distributions at the corners of the drawpiece show, that the results of the simulations are in good agreement with the real deep drawing process. The qualitative character of presented curves is preserved and the differences in contraction do not exceed 10%. It proves, that the simulation parameters were determined correctly and that the simulations are very useful in the analysis of the investigated deep drawing process.

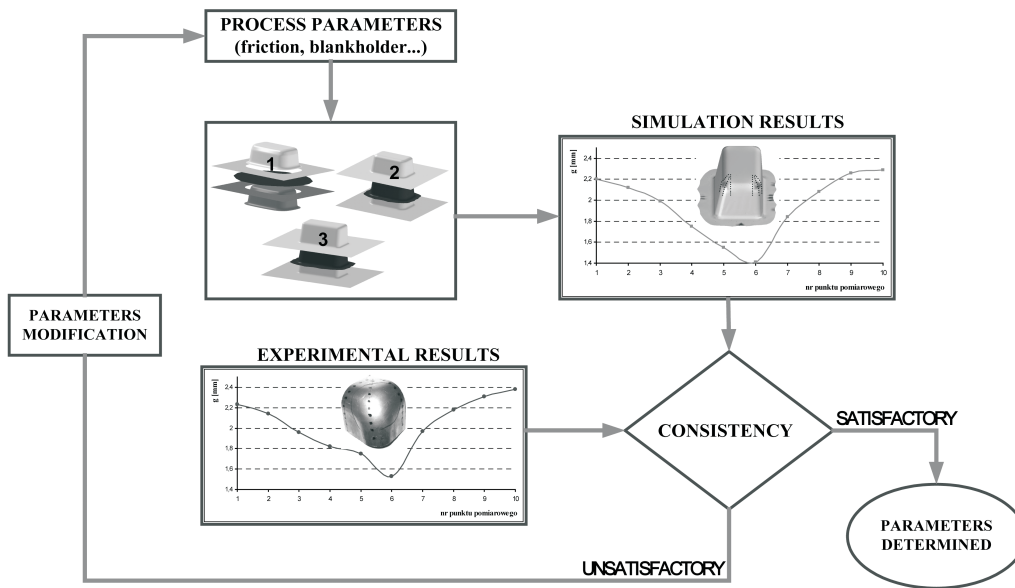

Fig. 6. The research procedure used to determine the process parameters

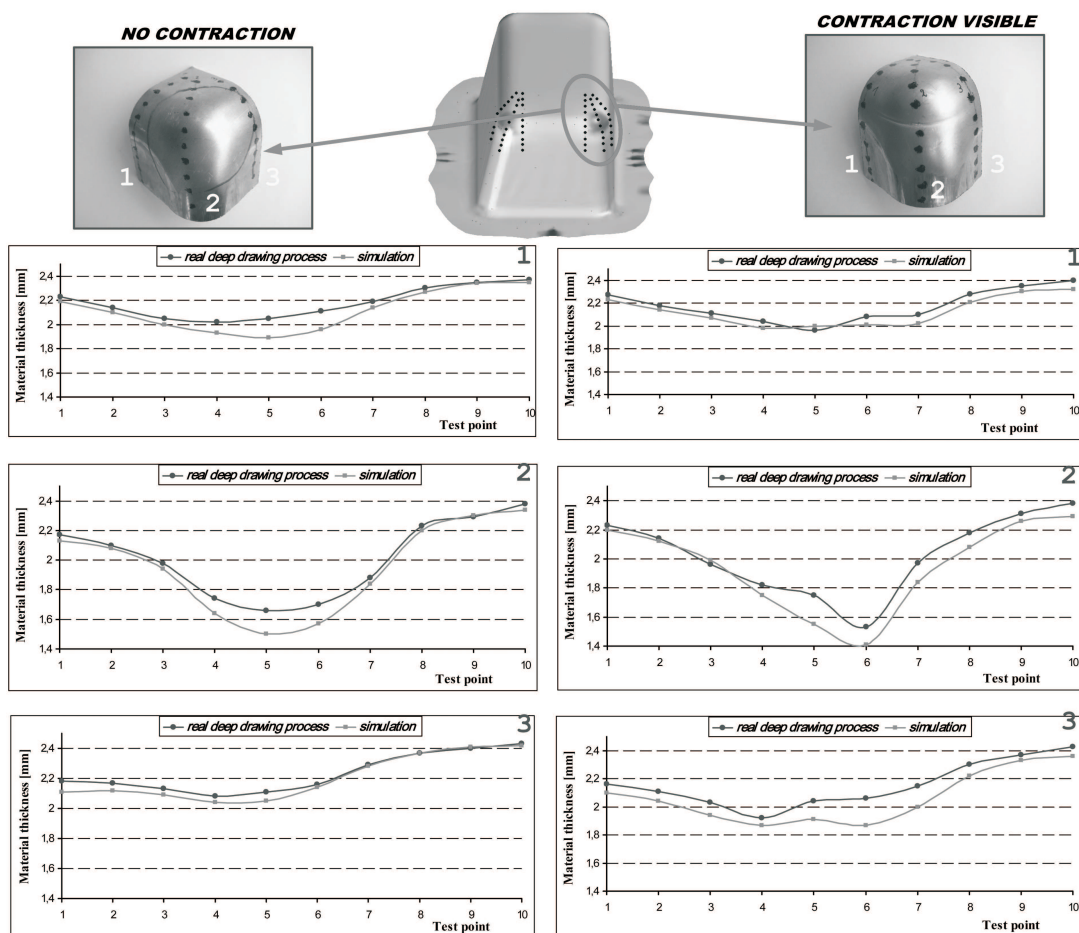

Fig. 7. Comparison of the material thickness distribution at the corners of drawpiece obtained from real deep drawing process and from the simulation

Moreover, the comparison of the material thickness distributions leads to the following conclusions:

- the largest contraction occurs in central areas of the drawpiece corners;
- contraction at the corners in the areas of steep slope of the side wall is greater than contraction at the corners in the areas on the opposite side of the drawpiece (lower angle of the slope of the side wall).

Second observation is particularly interesting, because it shows nonuniformity of the material flow connected with lack of symmetry of the manufactured part. The corners on the side of steeper slope of side walls are privileged areas for contraction and occurrence of crack. This statement is proved by the observation of real process as well as by performed simulations.

A characteristic feature of changes of geometry of semi-finished product during deep drawing process are changes of drawing force. In relation to the punch move-

ment. Fig. 9 shows force-punch displacement relationship for the investigated process. The nature of the force-punch displacement curve in the first stage of drawing indicates, that deformation takes place in the whole forming process, except first millimeters, when the punch approaches the surface of the blank. Initial linear increase of the force results from the increase of stresses in the material up to the moment, when the material flow starts. Till that moment the material deforms elastically.

During the second and third stage, rapid increase of the force can be observed in the final phase of deformation process, what is caused by increasing tools-semi-product contact surface, resulting in greater amount of deformation of the material. The greatest values of drawing force change from 600 kN in the first stage to 1000 kN in final redrawing. This phenomenon results from the increasing strain hardening of AA5754 alloy and from ongoing reduction of drawpiece radiuses.

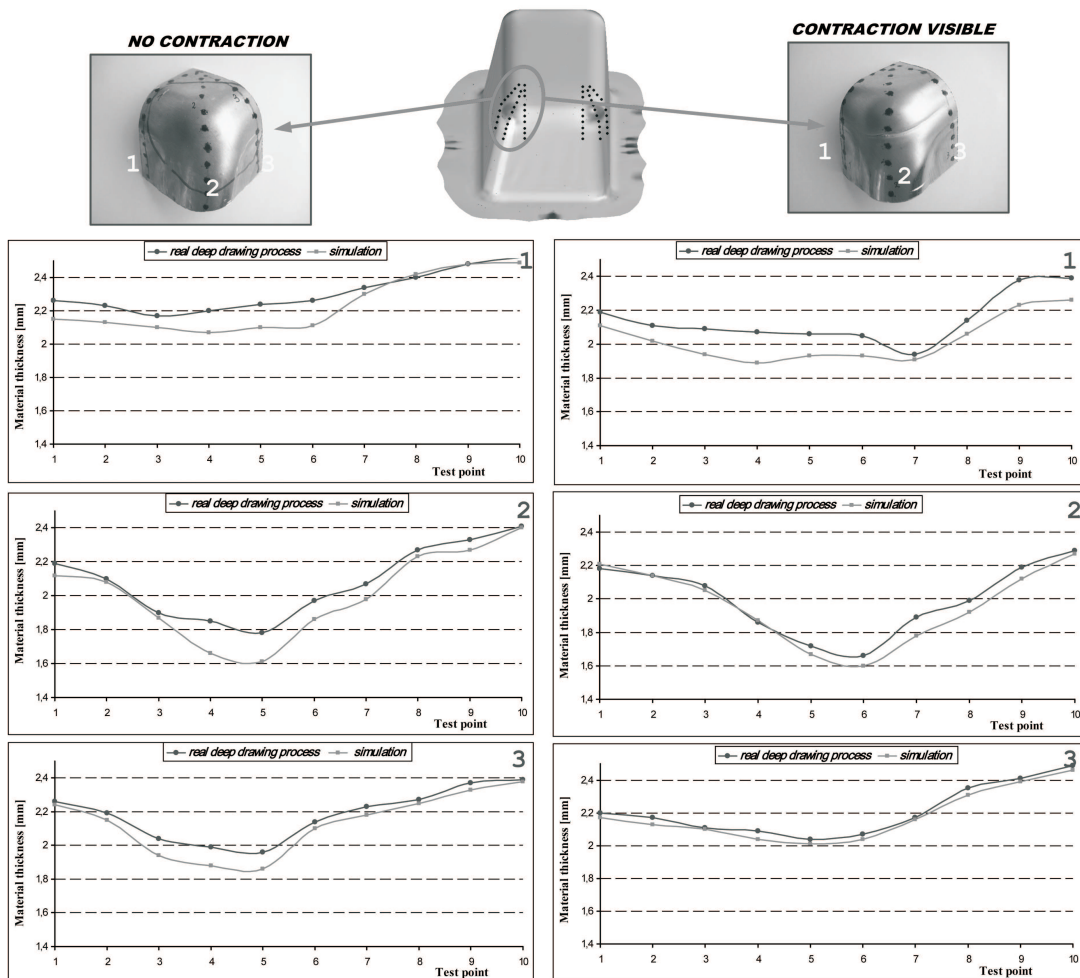

Fig. 8. Comparison of the material thickness distribution at the corners of drawpiece obtained from real deep drawing process and from the simulation

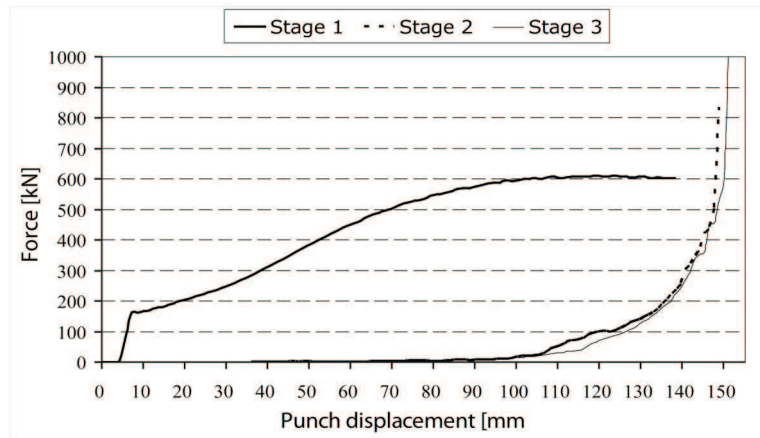

Fig. 9. Deep drawing force in relation to the punch displacement in the modeled process

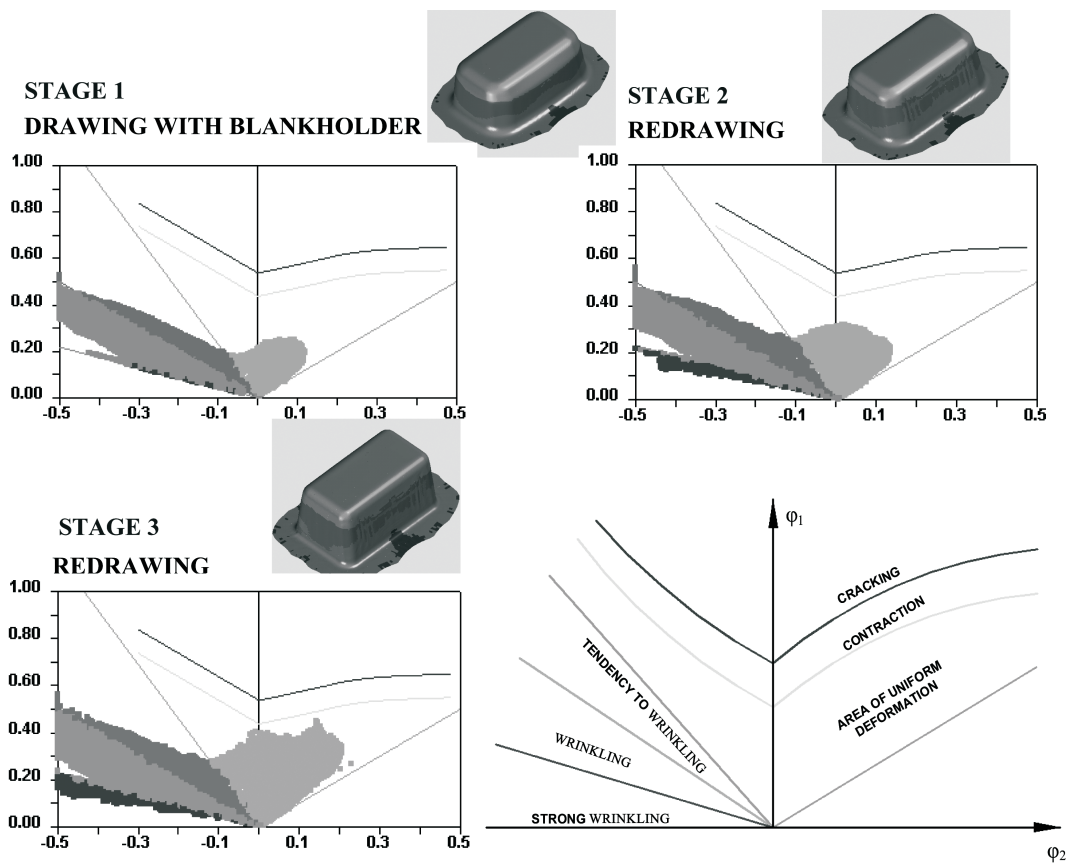

Fig. 10. Forming-limit diagrams (FLD) for all stages of deep drawing of investigated drawpiece

Forming-limit diagrams [7, 8] are strong basis in qualitative analysis of deep drawing process. The diagrams obtained from the simulation software database (for AA5754 alloy) for each drawing stage are show in Fig. 10.

Basing on forming-limit diagrams for the analyzed drawpiece, three areas of deformation can be distinguished: bottom of drawpiece – uniform deformation

area, side surface of drawpiece – the area of some tendency to fold, and flange – strong wrinkling area.

Strains increase in semi-finished product along with particular deep drawing stages, reaching the values close to critical ones causing contraction (stage 3). If the lubrication conditions are not proper, the friction coefficient locally increases, what leads to contraction or even cracking of the deformed material (Fig. 11).

Fig. 11 shows, that an increase of the friction coefficient restricts the flow of the material in the corners of drawpiece causing the material thinning in these areas. Significant changes in forming-limit diagrams may be noticed as shown along with the pictures of real drawing products, proving that the main causes of the material faults in the analyzed deformation process are connected with too high friction coefficient. The faults shown on the pictures of the real products were also revealed during the simulations.

Third stage of deep drawing, conducted according to technological guidelines (friction coefficient equal to 0.1), resulted in obtaining a fault-free product. However, it should be emphasized, that strains in deep-drawn material were very high, reaching the values close to these causing the faults in the material. When the friction coefficient equals 0.15, a contraction of the material occurs on the drawpiece corner at more steep slope of the side wall (right side).

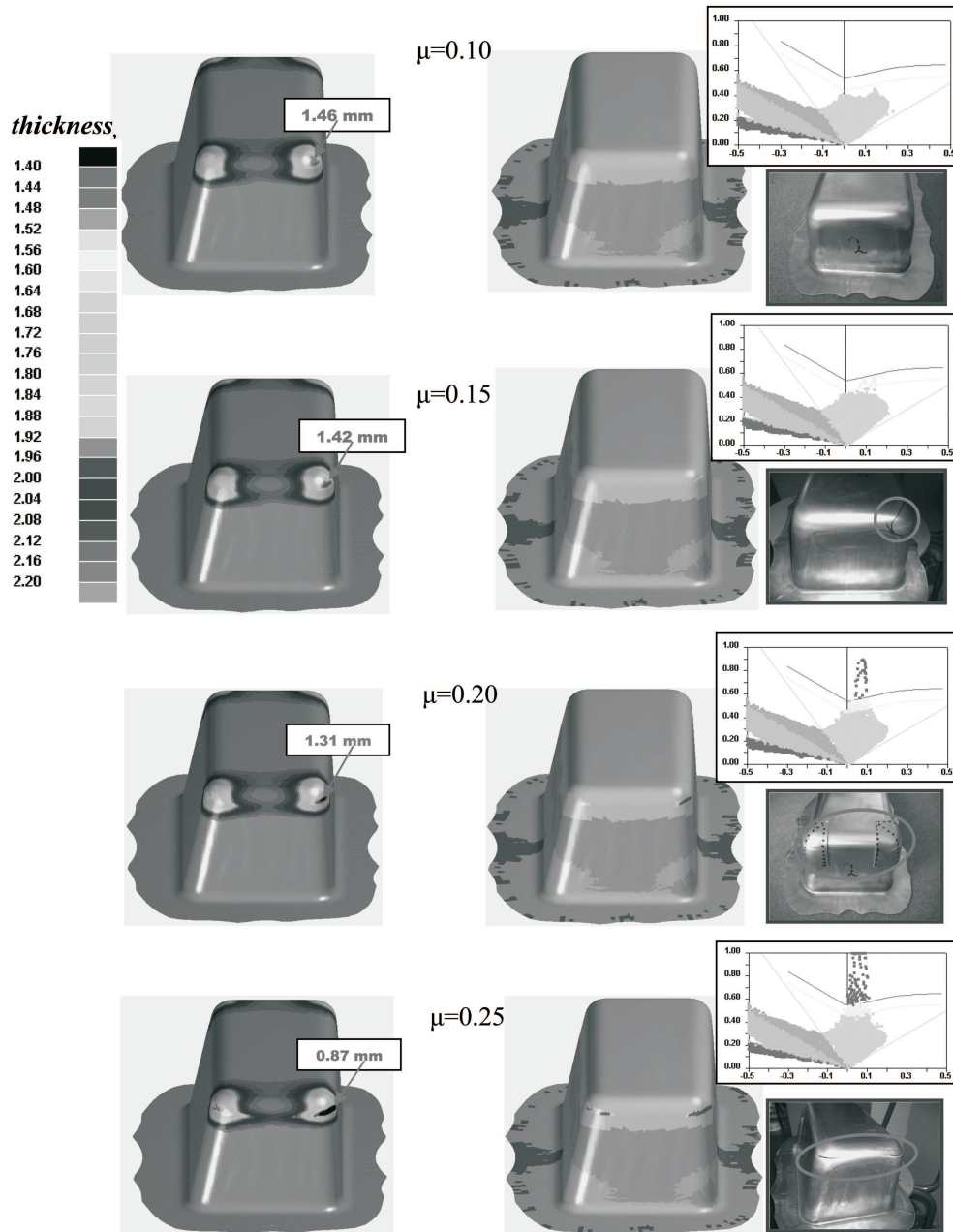

Fig. 11. The comparison of distribution of the material thickness at drawpiece corners along with forming-limit diagrams (FLD) for a finished product (increasing friction coefficient conditions) and with strain distributions (simulation) corresponding to the FLD and with pictures showing cracks occurring in real product



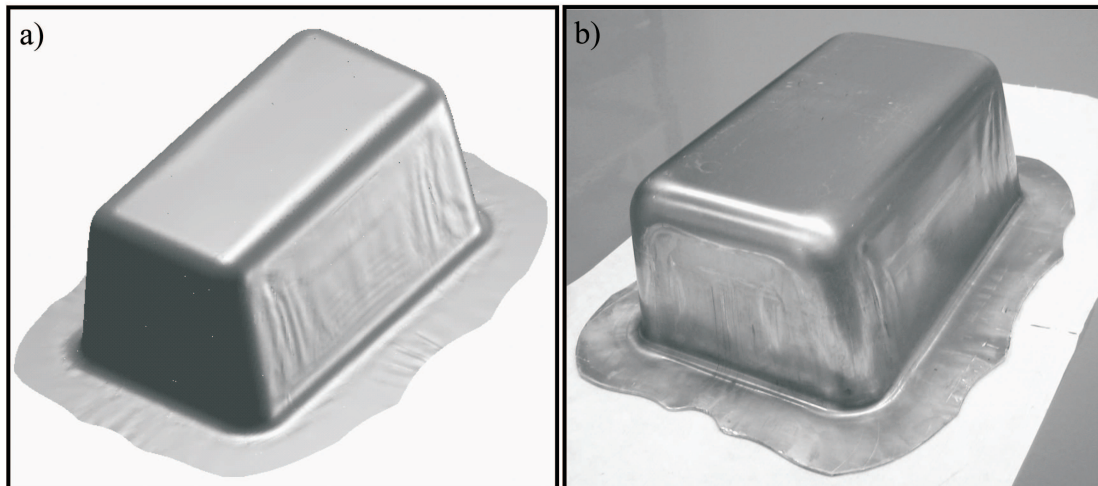

Fig. 12. Folding of the side wall of drawpiece: a) picture obtained from the simulation; b) picture of the real product

At this area, a thinning of the material is significantly greater than that on the opposite side of the drawpiece. Red colour marks the areas where the thickness of the sheet is close to 1.4 mm, which can be recognized as “safe” for the process. The opposite corner of the drawpiece is thicker (0.1 mm more thick) and is fault-free. When the friction coefficient increases (friction coefficient equals 0.20) semi-finished product cracks on the right side, and a contraction appears on the other side of the drawpiece. In this area a thinning is equal to 1.4 mm. At the moment of lubrication film cut-off (friction coefficient equal to 0.25), a bottom of the drawpiece can be detached. The thickness of the material significantly decreases and the area of sheet thinning rapidly increases. Strains exceed a critical value at many areas of a drawpiece causing crack development along shorter side of the bottom of drawpiece.

A wrinkling of mildly inclined side of the drawpiece is particularly interesting. This phenomenon can be observed in real deep drawing process, and its revealing in simulation proves proper selection of boundary conditions (Fig. 12).

The phenomenon of wrinkling of the side wall is very disadvantageous in the analyzed process in respect to significant thinning of drawpiece corners. The elimination of wrinkling by changing the geometries of semi-finished products or by the application of drawing threshold should reduce strains in critical areas of the drawpiece.

Basing on the analysis of the real process it can be stated, that friction coefficient should be precisely controlled during the final stage of deep drawing process

what is essential for obtaining fault-free product. However, even in this case, a safety margin is too small (Fig. 10). Because of this fact, the simulations taking into account smaller friction coefficient in all three stages of the analyzed deep drawing process were performed. A graphite-doped grease was assumed as a lubricant for all deformation stages in these simulations (Fig. 13a).

Greater uniformity of strain distribution in a drawpiece can be observed. It is most probably caused by more uniform material flow on the tool-drawpiece contact surface. Significant change can also be noticed in the first stage of deformation (pre-drawing of flat blank), where strains were significantly smaller. Properly defined blankholder force is essential at this stage of forming. Some changes of the material flow on blankholder-tools-deformed material contact surfaces are connected with modifications of friction conditions on tool-drawpiece contact surface.

The application of lower friction coefficient resulted in lower strains in each forming stage causing an increase of the thickness of the material at its corners (Fig. 14). This enhances a safety margin in the analyzed process and lowers the risk of contraction or cracks to occur.

The thickness of the deformed sheet in the thinnest area increased for only 0.02 mm, what could lead to wrong conclusion, that the improvement of friction conditions insignificantly influences the deep drawing process. But if a thickness distribution in all drawpiece corners is taken into consideration, a decrease of thinning of shorter side-wall of drawpiece can be observed, what is particularly important due to the fact, that this area is the most probable place of cracking.

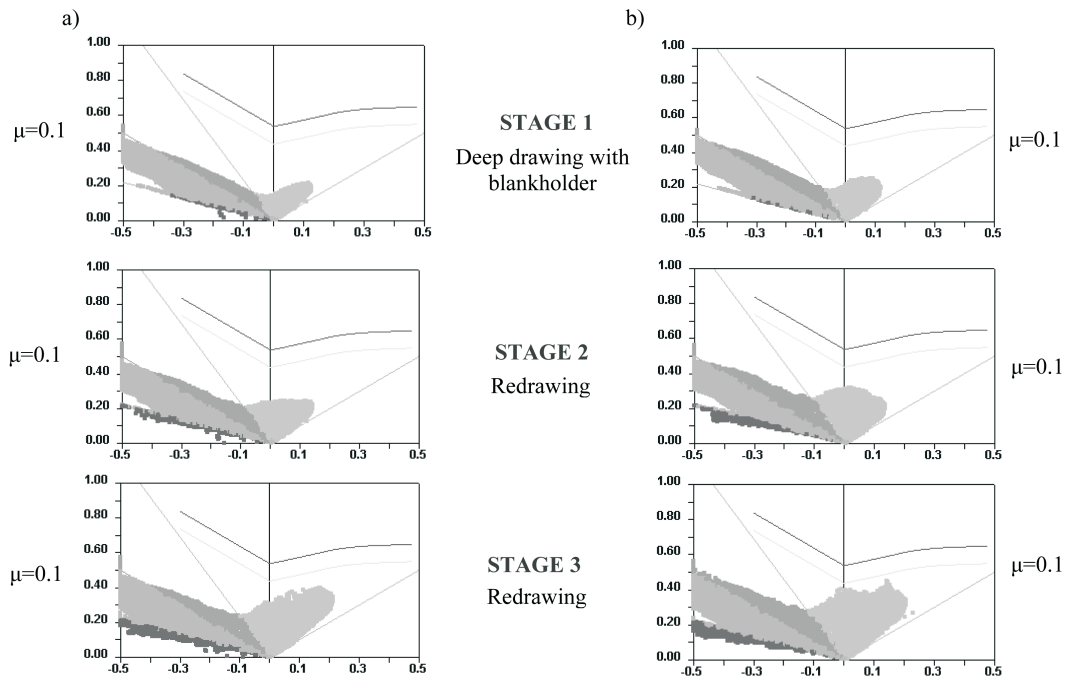

Fig. 13. Comparison of forming-limit diagrams: a) in the simulation of deep drawing (reduced friction coefficient); b) in real deep drawing process

As mentioned above, the first stage of deep drawing (pre-drawing) is very important for the entire process. Properly defined blankholder force, as well as properly specified friction conditions, strongly influence the reduction of flange. A relation between the uniformity of the material flow and its inclination to wrinkling should

be taken into account in proper design of deep drawing process (Fig. 15).

Different friction conditions (Table 1) influenced drawpiece thickness distribution, what was shown in Figure 11 and in Figure 14.

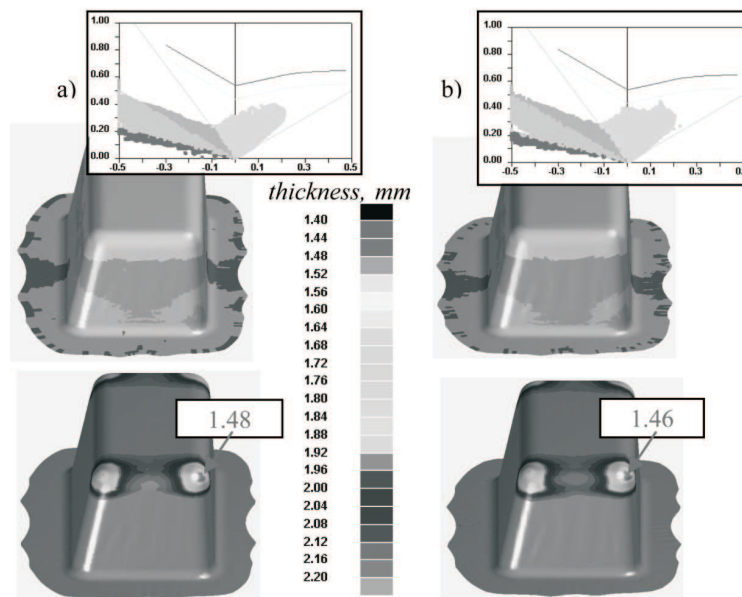

Fig. 14. Material thickness distributions at drawpiece corners along with forming-limit diagrams for a final product: a) simulation of the process (lower friction coefficient applied); b) simulation of real deep drawing process

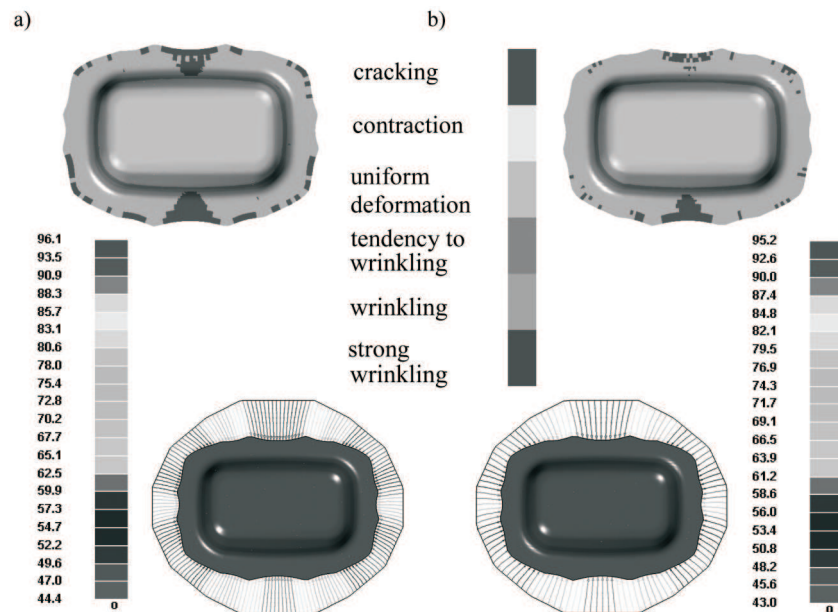

Fig. 15. The influence of flange reduction on the flange wrinkling: a) simulation of deep drawing process (lower friction coefficient applied); b) simulation of real deep drawing process

In the analyzed process lower friction coefficient caused more uniform flow of drawpiece material on blankholder-tools-drawpiece contact surfaces causing greater wrinkling of the flange (Fig. 15). This, however, does not restricts the final product from meeting the quality requirements, because such range of wrinkling is acceptable. The application of lower friction coefficients seems to be very advantageous in the analyzed deep drawing process.

#### 4. Conclusions

Basing on the analysis of multistage deep drawing of a box-type part with flange, made of AA5754 aluminum alloy, the following conclusions can be drawn:

1. The results of the simulation performed using eta/DYNAFORM software are in very good agreement with the results of the real multistage deep drawing processes.
2. Forming-limit diagrams are very important for qualitative analysis of strains at each stage of deep drawing process. In the investigated multi-stage drawing, different areas of the analyzed drawpiece – compared with the results of the numerical simulation combined with forming-limit diagrams – precisely reflect a real behavior of the investigated material in each stage of deformation.
3. The corners of the box-type parts are crucial in respect to the analysis of the investigated deep drawing process. Contraction of the material as well as cracking caused by significant tensile stresses often occur in these areas of a drawpiece.
4. Proper conditions of friction on the tool-drawpiece contact surface is crucial for the correctness of the analyzed deep drawing process. Too great friction can restrict the material flow, particularly along the edge connecting the bottom and side-walls of the drawpiece, causing wrinkling and cracking.
5. Basing on the observations of deep drawing of AA5754 aluminum alloy box-type part in industrial conditions it can be stated, that the friction conditions can be improved both by the application of suitable lubricants and proper selection of the areas of drawpiece to be lubricated. While lubricating the punch, particular attention should be paid to its corners and edges connecting the bottom and side-walls, but also to drawpiece-tools contact surfaces with special emphasis to the areas of side-walls-flange transition. These observations are partly confirmed by the results of the simulations (Figure 11).
6. An increase of drawing force in the consecutive stages of the investigated multistage deep drawing of AA5754 aluminum alloy box-type part can be observed. It is most probably caused by the reduction of the radiuses of drawpiece corners as well as by the reduction of the radiuses of side surfaces. Moreover, great ability of AA5754 to strain hardening also significantly influences drawing force.

### Acknowledgements

The research presented in this study was performed in co-operation with Deep Drawing Division of Finnveden Metal Structures - one of the main suppliers of deep-drawn parts for automotive industry.

### REFERENCES

- [1] S.H. Zhang, K.B. Nielsen, J. Danckert, D.C. Kang, L.H. Lang, Finite element analysis of the hydromechanical deep-drawing process of tapered rectangular boxes, *Journal of Materials Processing Technology* **102**, 1-8 (2000).
- [2] G. Gantar, K. Kuzman, Sensitivity and stability evaluation of the deep drawing process, *Journal of Materials Processing Technology* **125-126**, 302-308 (2002).
- [3] G. Gantar, K. Kuzman, B. Filipič, Increasing the stability of the deep drawing process by simulation-based optimization, *Journal of Materials Processing Technology* **164-165**, 1343-1350 (2005).
- [4] S. Chengzhi, C. Guanlong, L. Zhongqin, Determining the optimum variable blank-holder forces using adaptive response surface methodology (ARSM), *Int. J. Adv. Manuf. Technol.* **26**, 23-29 (2005).
- [5] L. Lang, T. Li, D. An, C. Chi, K. Brian Nielsen, J. Danckert, Investigation into hydromechanical deep drawing of aluminum alloy—Complicated components in aircraft manufacturing, *Materials Science and Engineering* **A499**, 320-324 (2009).
- [6] W. Zhang, R. Shivpuri, Probabilistic design of aluminum sheet drawing for reduced risk of wrinkling and fracture, *Reliability Engineering and System Safety* **94**, 152-161 (2009).
- [7] J. Gronostajski, A. Matuszak, A. Niechajowicz, Z. Zimniak, The system for sheet metal forming design of complex parts, *Journal of Materials Processing Technology* **157-158**, 502-507 (2004).
- [8] J. Gronostajski, Z. Zimniak, A Few methods of analytical calculation of forming-limit curves, *Journal of Materials Processing Technology* **55**, 213-217 (1995).