

ARCHIVES
of
FOUNDRY ENGINEERING



ISSN (2299-2944)
Volume 12
Issue 2/2012

DOI: 10.2478/v10266-012-0071-4

Published quarterly as the organ of the Foundry Commission of the Polish Academy of Sciences

267 – 272

Applications of Monitoring of Electric Power Parameters to Performance Evaluation of a Model Vacuum-Assisted Moulding Installation

E. Ziółkowski*, M. Brzeziński, R. Wrona, K. Smyksy, P. Zyzak

AGH, Foundry Engineering, Department of Foundry Processes Engineering, Reymonta 23, 30-059 Krakow, Poland

*Corresponding author. e-mail address: ez@agh.edu.pl

Received 25-05-2012; accepted in revised form 31-05-2012

Abstract

Vacuum conditions in foundry installations are generated using electric-driven vacuum pumps. The purpose of the experiment is to evaluate the performance of a vacuum-assisted system for compaction of moulding sand basing on registered plots of selected electric power parameters of the power-supplying system of the pumps. Model testing done on an experimental vacuum system installation, power-supplied from a system incorporating the recorders of instantaneous current and voltage values. Following the numerical procedure, the experimental data are analysed to yield mathematical relationships between the variations of the generated vacuum pressure levels and variations of selected electric power parameters. Registered and computed values of selected parameters: instantaneous and RMS voltage and current values, active, reactive and apparent power levels and power coefficient allow for diagnosing the adequacy and reliability of the system operation. According to the authors, the applied monitoring of the power parameters of a vacuum-assisted installation may become an effective and easy practical method of evaluating the performance of such installations, used also in foundry plants.

Keywords: Mechanisation and Automation of Foundry Processes, Electric Power Measurements, Vacuum-Assisted Moulding Processes

1. Introduction

Monitoring of foundry operations executed by machines in foundry plants is a major aspect involved in supervision, control and regulation procedures and in identification of the working condition of machines and installations [1, 2, 3, 4]. The methodology underlying the monitoring programs is well applicable in testing the operation of machines and installations in foundry plants.

The monitoring process involves three aspects:

- process preparation, organising of operation

- realisation; operation and maintenance of the installations (machines, plants) and material handling units in foundry plants where they are used accordingly in the designed and defined manner
- evaluation of the system operation, involving the performance testing of single machines as well as systems of equipment, installations and groups of machines making up the process lines

These systems and their respective components experience variable loads whilst in service. Under variable loading the functional and performance parameters of machines will change and processes taking place in installations involving several

structural components may undergo some changes as well. The quantitative evaluation of applied loading is the field of reliability testing. It is assumed that research data should include the specification data and parameters quoted by manufacturers of foundry equipment and by specialised organisational units within the foundry plants. Reliability and accuracy of the supplied data depend on the actual criteria adopted for the assessment of the condition of the process or system. In the test procedure we have operational parameters at the input and performance parameters at the output, associated with the machine or process conditions.

The operational model may use the following quantities:

- decision variables, which are controllable,
- context-related or independent variables, which cannot be controlled,
- dependent variables, which depend on the applied solution,
- variables and goals used as the criteria in the optimisation procedure

It is readily apparent that some of these quantities are obtained from measurements requiring specialised methods to derive their operational characteristics. The measurement of relevant energy parameters seems most reliable in these applications [5, 6, 7].

2. Principles of the measurement method of electric power parameters and the range of its applications

The above mentioned method was developed at the Chair of Mechanisation, Automation and Design of Foundries at the Faculty of Foundry Engineering, AGH UST [among others 8, 9].

Measurements of electric power parameters are taken with a prototype recorder of instantaneous quantities, designed and fabricated for the purpose of the experiment and shown in Fig 1. The measurement system incorporates a processor CS5451A (Cirrus Logic) having six channels with 24 bit resolution (Fig 2). These channels are used for measuring instantaneous voltage and current levels in each phase of the three-phase installation power-supplying the investigated foundry machines. The main module of the electronic recorder is shown in Fig. 3. The recorder executes 4000 measurements per second, concurrently in each of the six channels. Recorded data are transmitted to the computer via a USB interface (version 2.0). Besides, the newly designed recorder enables the measurements to be taken in foundry machines powered directly from the mains or via inverter systems. The application scheme of the recorder is shown in Fig. 4.

The operation of the instantaneous voltage and current recorder is supported by the computer program developed by the authors. The program establishes the computer-recorder connection, stores the measurement data in its memory, generates visualised plots of instantaneous current and voltage and power levels and executes the scheduled calculations of other electric power parameters using the digital data processing algorithms.

Since the DSP algorithms in the dedicated computer program can be selected, we get a predetermined number of measured RMS values per second, which is a major advantage of this method over conventional measurement systems. Based on the

registered voltage and current levels, the following electric power parameters can be determined:

- RMS voltage and current levels in each phase,
- active, reactive and apparent power levels,
- power coefficients $\cos\phi$ and $\tan\phi$,
- fundamental frequency for the selected run of voltage or current,

All measured signals and those derived by the computer program can be saved and exported to other programs, such as spreadsheets.

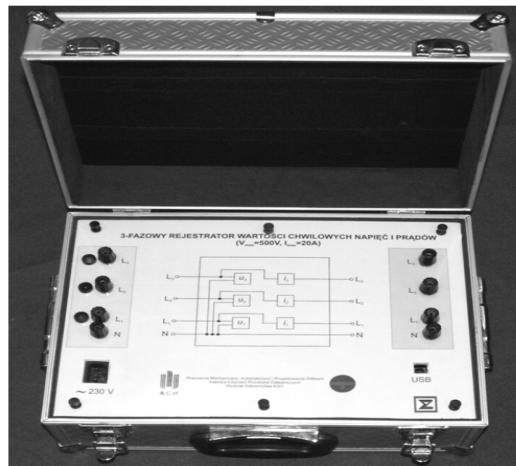

Fig. 1. Recorder of instantaneous voltage and current signals- general view

A major advantage of the recorder is that it can be incorporated in the circuits supplying inverter-controlled electric motors. This feature is unavailable in many commercial systems for power measurements in electric power installations.

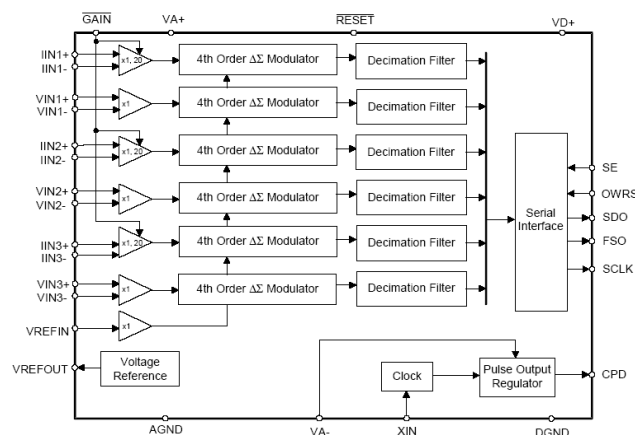

Fig. 2. Block diagram of the system CS5451A (Cirrus Logic) [10]

The usefulness of power measurements in monitoring of foundry processes is demonstrated by laboratory testing done on selected process machines. So far the method and the measurement equipment has been tested when investigating the

mixing processes in paddle, roller and rotary foundry mixers. [8, 11, 12, 13].

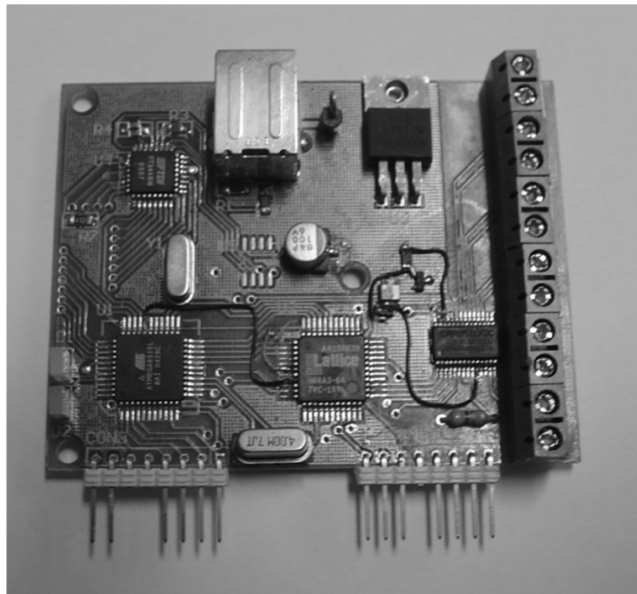

Fig. 3. Electronic module- general view

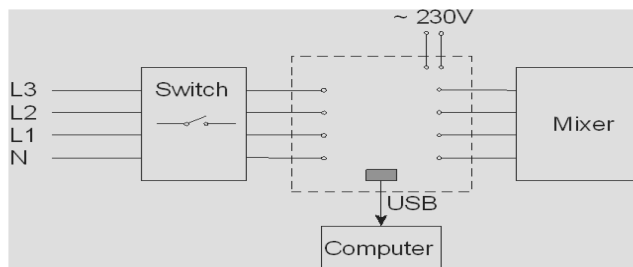

Fig. 4. Application diagram of the instantaneous voltage and current recorder

Tests are now underway covering the moulding sand compaction processes on moulding stands..

One of the processes selected for testing is the vacuum-assisted moulding process.

3. Test facility

The test facility comprises a model constructed by analogy to solutions used in industry, incorporating the following systems:

- a vacuum installation system with moulding chamber as a physical model of a moulding machine,
- measurement system in the vacuum installation,
- measurement data recording system.

The vacuum installation system represents a physical model of a moulding machine comprising:

- a vacuum source: two vacuum pumps with the power ratings 0.18 kW each, connected to the moulding chamber via electromagnetic valves,

- vacuum internal chamber comprising two cylinders 110 and 190 mm in diameter and having the volume $V_1=4.75 \text{ dm}^3$ and $V_2=9.42 \text{ dm}^3$.

These components are connected with a pipe installation and ball valves WKK4a, forming a spatial structure of three chambers having the respective volumes $V_1=4.75 \text{ dm}^3$, $V_2=9.42 \text{ dm}^3$ and $V^3=14.17 \text{ dm}^3$ (sum of V_1 and V_2). This configuration allows for extending the scope of the experimental program, so the influence of the chamber volume on the compaction performance can be investigated without expanding the test stand (Fig 5) [14,15].

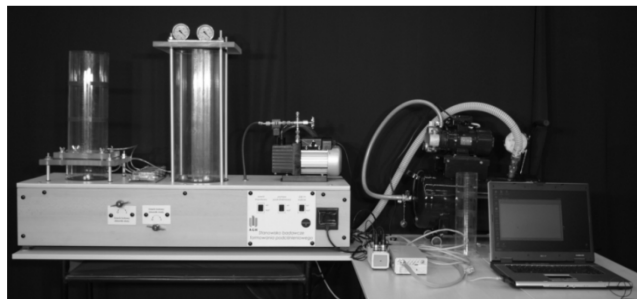

Fig. 5. Model stand for investigating vacuum forming installations [14]

The circuit for measuring the vacuum levels comprises four differential pressure transducers MPX2100, manufactured by Motorola. Analogue signals are further amplified by signal amplifiers MC33272A. Pressure transducers are connected to the vacuum installation via an elastic pipe conduit and are located at four points:

1. The vacuum installation under the impulse valve
2. The chamber under the pattern plate
3. Vacuum tank
4. Moulding chamber

Such configuration allows the pressures to be registered at the key points of the installation.

The recording system incorporates a microprocessor-based digital recorder. This configuration ensures most accurate recording of analogue data from the measurement circuit. Data are sampled at the frequency 300 Hz for each transducer system. The recorder has a number of extensions and seats to enable the remote-control activation of the recording process and real-time data transmission to the computer via the RS232 and USB ports, at variable speed of data transfer [14, 15].

Measurements of electric power parameters in the laboratory conditions are taken with another measurement system incorporating a described above recorder of instantaneous current and voltage levels.

4. Measurements of electric power parameters in the experimental installation

The experimental program involves the measurements of electric power parameters whilst the vacuum is being generated in

the installation connected to two pumps. The vacuum installation comprises two chambers differing in volume. Since the installation is equipped with two vacuum pumps, measurements can be taken in various configurations: pump 1, pump 2 and for two pumps operated concurrently. Plots of instantaneous values of current, voltage and instantaneous power are shown in Fig 6 in two time windows. Instantaneous values are registered in the start-up phase and during the steady-state operation of two vacuum pumps in the large-volume chamber. Registered graphs deviate from the current intensity plots in the supply system, revealing large levels of instantaneous power at the instant the supplying system is activated to power the two pumps. That suggests the necessity to design and use the noise filtering

systems as well as protective elements to be used in the electric supply systems.

Large levels of instantaneous power registered at the instant when the supply system is switched on are also revealed on plots of active power and the generated vacuum levels (Fig. 7). The maximal active power at the instant the supply system is switched on is decidedly larger than power uptake by the pump in the phase of its stable operation.

It is apparent (see Fig. 4) that the variation of the vacuum level causes a change of the active power uptake by the vacuum pump. In the investigated time period, the active power level changes from about 160 W to 172 W, that is by 8-9%. This is a significant change and, when registered, allows for monitoring the vacuum generation process, supported by dedicated algorithms.

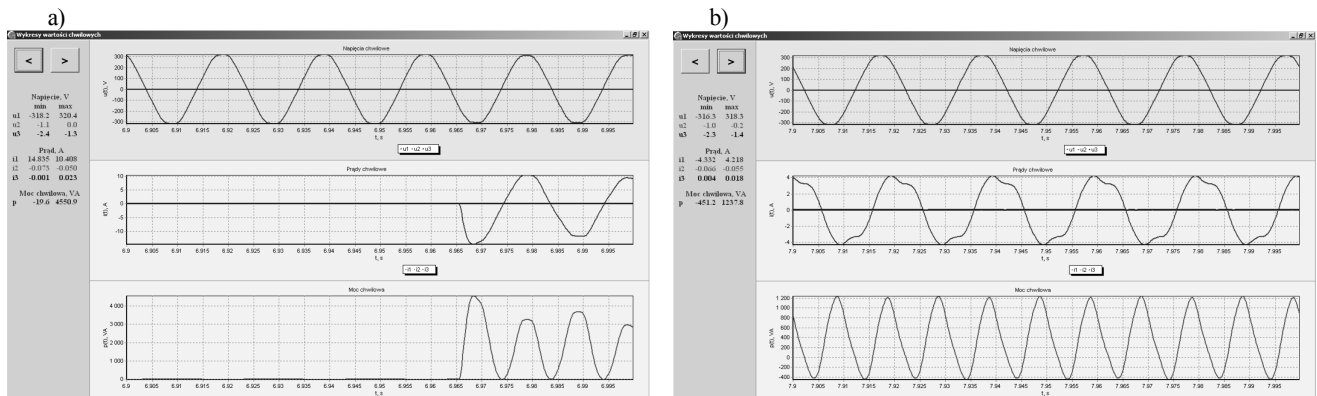

Fig. 6. Registered plots of instantaneous voltage and current intensity levels: a) when power-supply to the two pumps is switched on; b) during the steady-state operation of the two pumps

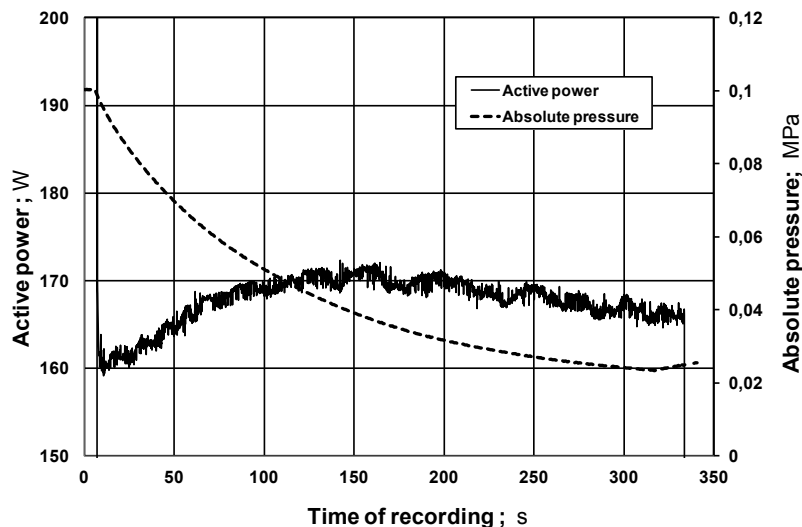

Fig. 7. Active power uptake by the pump 1 and vacuum levels in the experimental installation

Fig. 8 shows the plot of active power registered when vacuum pressure is generated in the supply system, for each pump separately and for two pumps operating concurrently. It can be easily seen that the loading characteristic of the pump 2 changes significantly when a certain level of vacuum pressure is achieved. In the case of the pump 1, this phenomenon is not observed. Though both pumps are single-stage pumps, their operational characteristics will differ, these differences being attributable to their design features and the level of wear and tear.

To eliminate potential malfunctions of the pump 2, a thorough diagnostic procedure is applied. Electric power parameters specific to the pump operation after changes identified by the diagnostic procedure are shown in Fig 9, revealing that the time period after which the pump characteristic is changed becomes much shorter. Besides, the absolute pressure level in excess of which the pump characteristic gets changed is higher, too. It appears that despite the applied diagnostic procedure the effect of the two-stage pump characteristic cannot be eliminated.

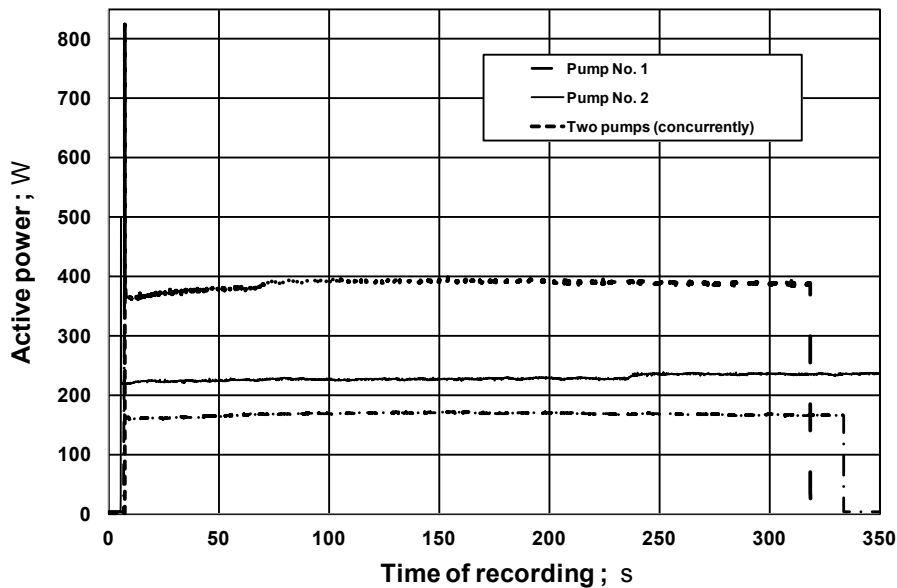

Fig. 8. Active power registered in the course of the vacuum-assisted process

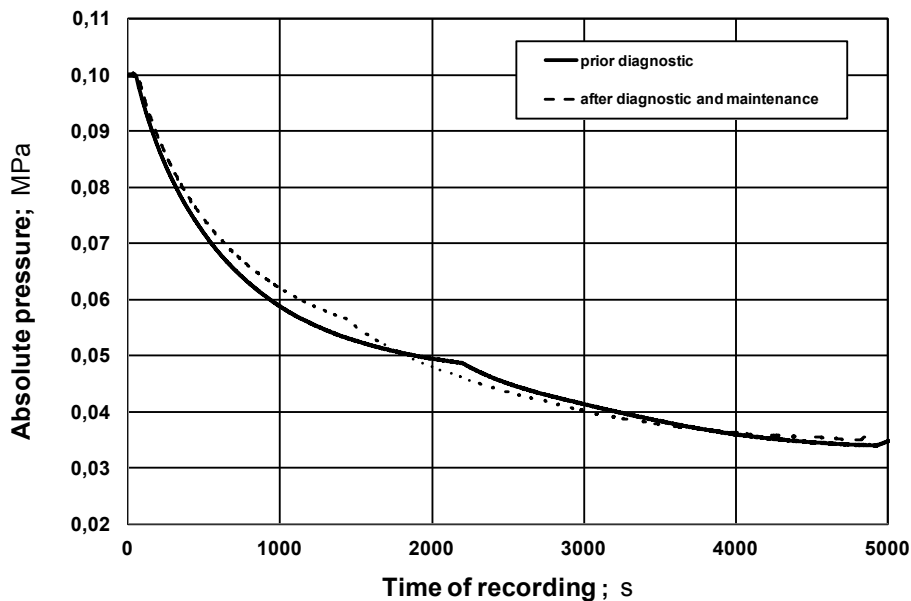

Fig. 9. Vacuum pressure changes prior to and after the applied diagnostic procedure

5. Conclusions

Measurements of electric power parameters and their interpretation confirm the adequacy of the developed method in process monitoring.

Measurements of electric power parameters are actually much easier and more effective than other methods, particularly those involving non-electric quantities. Electric power measurements allow for online control of processes and enable the diagnosis and identification of malfunctions of machines and installations in the process line.

Further research work will merit to develop a mathematical model of a vacuum moulding process. Measurements of vacuum pressures in modelled installations will be supported by electric power parameters measurements in supply systems of the pumps.

Acknowledgements

The research was performed within the grant of MNiSW No. 11.11.170.318-6.

References

- [1] Macioł, A., Wrona, R. & Stawowy, A. (2010). An application of advanced information technology in foundry engineering. *Archives of Foundry Engineering* 10 (2), 83-88.
- [2] Kukła, S. (2011). Maintenance system improvement in cast iron foundry. *Archives of Foundry Engineering* 11 (3), 185-188.
- [3] Kukła, S. (2009). Total productive maintenance on example of automated foundry lines. *Archives of Foundry Engineering*, 9 (3), 71-74.
- [4] Fedoryszyn, A. (2010). Quality stabilisation of synthetic sand containing bentonite in process lines. *Archives of Foundry Engineering*, 10 (3), 143-148.
- [5] Ziółkowski, E., Wrona, R. & Smyksy, K. (2009). Some aspects of monitoring of foundry moulding sands preparation process. *Archives of Metallurgy and Materials* 54 (2), 399-411.
- [6] Fedoryszyn, A. & Rudy, C. (2009). Operating characteristics of turbine mixers based on the analysis of power demand of the mixer's drive. *Archives of Foundry Engineering* 9 (1), 65-68.
- [7] Smyksy, K., Wrona, R. & Ziółkowski, E. (2011). Application of a power quality analyser to the monitoring of sand preparation processes in foundry plants. *Archives of Foundry Engineering* 11 (4), 141-144.
- [8] Wrona, R., Ziółkowski, E. & Smyksy K. (2008). Monitoring of power demand of foundry machinery, using the example of paddle mixers. *Archives of Foundry Engineering* 8 (1), 177-182.
- [9] Ziółkowski, E. (2010). Monitorowanie pracy układów zasilania elektrycznych urządzeń odlewniczych. *Archives of Foundry Engineering* 10 (spec. 2), 169-172. (in Polish).
- [10] www.cirrus.com
- [11] Ziółkowski, E. (2009). Compensation of reactive power in the power-supplying system in a roller mixer in laboratory conditions. *Archives of Foundry Engineering* 9 (3), 227-230.
- [12] Ziółkowski, E. (2009). Investigation of power consumption by a laboratory roller mixer. *Archives of Foundry Engineering* 9 (1), 61-64.
- [13] Smyksy, K., Wrona, R. & Ziółkowski, E. (2010). Analysis of power demand signal in laboratory rotary mixer. *Archives of Foundry Engineering* 10 (2), 151-154.
- [14] Brzeziński, M. (2010). Evaluation of vacuum assisted compaction processes of foundry moulding sand by theoretical and experimental methods. *Archives of Metallurgy and Materials* 55 (3), 763-770.
- [15] Brzeziński, M., & Wrona, R. (2011). Evaluation of automatic vacuum- assisted solution. *Archives of Foundry Engineering* 11 (1), 113-117.