

ARCHIVES
of
FOUNDRY ENGINEERING

 VERSITA

DOI: 10.2478/v10266-012-0107-9

ISSN (2299-2944)
Volume 12
Issue 4/2012

Published quarterly as the organ of the Foundry Commission of the Polish Academy of Sciences

57 – 64

Mechanical Properties of Al-Si-Mg Alloy Castings as a Function of Structure Refinement and Porosity Fraction

M. Hajkowski*, L. Bernat, J. Hajkowski

Division of Foundry, Institute of Materials Technology, Poznan University of Technology,
Piotrowo Street 3, 60-965 Poznan, Poland

*Corresponding author. E-mail address: mieczyslaw.hajkowski@put.poznan.pl

Received 09.07.2012; accepted in revised form 03.09.2012

Abstract

During design of the casting products technology, an important issue is a possibility of prediction of mechanical properties resulting from the course of the casting solidification process. Frequently there is a need for relations describing mechanical properties of silumin alloys as a function of phase refinement in a structure and a porosity fraction, and relations describing phase refinement in the structure and the porosity fraction as a function of solidification conditions. The study was conducted on castings of a 22 mm thick plate, made of EN AC- AlSi7Mg0,3 alloy in moulds: of quartz sand, of quartz sand with chill and in permanent moulds. On the basis of cooling curves, values of cooling rate in various casting parts were calculated. The paper also presents results of examination of distance between arms in dendrites of a solid solution α (DASL), precipitations length of silicon in an eutectic (DISi) and gas-shrinkage porosity (Por) as a function of cooling rate. Statistical relations of DASL, DISi, Por as a function of cooling rate and statistical multi-parameter dependencies describing mechanical properties (tensile strength, yield strength, elongation) of alloy as a function of DASL, DISi and Por are also presented in the paper.

Keywords: Mechanical properties, Silumin, Cooling rate, Structure, Porosity

1. Introduction

Increasing need for castings made out of aluminium alloys and high quality requirements are a reason behind the necessity of having a possibility of prediction the mechanical alloys casting properties resulting from the design and course of the solidification process, as early as on the design and casting process planning stages. Prediction of mechanical properties of alloys in foundry engineering during design of casting and its production technology should be based upon relations of mechanical properties of alloy with relevant parameters of crystalline structure and fraction of gas-shrinkage porosity in

relation with solidification conditions, with determined metallurgical quality of the alloy.

Silumins have a tendency for volume solidification and crystallizing eutectic, forming in temperature lower than eutectic ($\alpha+\text{Si}$), are locally isolated from feeding with the liquid alloy; these factors influence both macro and micro-shrinkage porosity in the casting structure [1, 2]. Hydrogen contained in the liquid alloy forms the gas porosity, which is why gas-shrinkage porosity is usually present in castings of these alloys.

In castings made of a specific silumin, crystalline structure refinement and fraction of porosity are two very relevant factors influencing mechanical properties of the casting.

The literature contains descriptions of relations between the mechanical properties and the structure, between the structure and the solidification conditions [3, 4, 5, 6, 7] and between the porosity and the solidification conditions [8, 9, 10], but there are no detailed descriptions useful for analysis and prediction of mechanical properties with simultaneous consideration of important geometrical parameters of phases in the casting structure and fraction of gas-shrinkage porosity.

Improving mechanical properties of silumin castings by alloy modification with strontium aimed at precipitation of an eutectic silicon in form of a fibrous spherical skeleton has impact on increase of fraction and size of pores in slowly solidifying sites. The pores are not separated from the hydrogen contained in the liquid alloy, so more gases can diffuse to shrinkage pores in slowly solidifying part of the casting [2]. Modification of strontium-modified alloys with titanium and boron causes refinement of dendrites of α solid solution and makes pores in slowly solidifying places smaller and distributed in a larger volume [2].

As it is known, modification of silumins with strontium causes significant increase of mechanical properties, especially the elongation [11, 12, 13, 14, 15], but in castings loaded with fatigue stresses, after some number of cycles, increase of porosity fraction decreases fatigue strength more intensely than improves the refinement of structure [15, 16].

Cooling rate has a significant influence on the structure refinement and also on volume fraction of porosity in the casting [2, 9, 10]. Independently of the chemical constitution of the alloy, efficiency of conducted refining of solid and gas impurities and conducting the modification of precipitations of α phase and silicon in eutectic, increase of cooling rate always causes decrease of the porosity fraction. For example, a casting made of an A356 alloy containing $0,25 \text{ cm}^3/100 \text{ g}$ hydrogen, modified with 200ppm of Ti with cooling rate of 0,9, 8 and 30°C/s has a porosity fraction respectively: 0,7, 0,7 and 0,03% while modified with 600ppm Sr and 200ppm Ti – 1, 0,18 and 0,09% respectively [9].

The aim of the work is a detailed analysis of refinement of main phases of the structure and porosity fraction as a function of cooling rate and also analysis of mechanical properties as a function of refinement of main structure phases and porosity and preparation of statistical relations.

2. Research methodology

The research was conducted on castings of a plate of dimensions shown in the fig. 1a, made out of EN AC- AlSi7Mg0,3 silumin of the following chemical constitution (in %): 7,37Si, 0,34Mg, 0,1Fe, 0,17Ti, 0,01Mn, the rest – Al.

A metallurgical process of alloy preparation was carried out in laboratory resistance furnace K4/13 from Nabertherm company, in a SiC crucible of 4 litres capacity.

Temperature of an alloy during the metallurgical treatment was $720 \pm 10^\circ\text{C}$ and air humidity near the furnace and the mould was $55 \pm 5\%$. The alloy was modified with strontium in quantity of 250 ppm and Ti5B1, also in quantity of 250 ppm of the charge mass. Constant conditions of liquid alloy preparation were applied (covering slag, refining of solid impurities (using “degasal T 200”) and hydrogen: first hydrogen refining using

tablet in quantity of 0,2% charge mass and second hydrogen refining – run-purging with nitrogen using graphite lance in time of 5 minutes).

Refinement of the structure and fraction and distribution of porosity in the casting are dependent on the solidification conditions. The conditions were variable thanks to various mould materials (fig. 1b): moulding quartz sand – P, steel permanent mould – K and application of different materials in the mould (quartz moulding sand and copper chill – PO). The moulds were poured as the sets:

- vertical – 6 sand moulds, 6 sand moulds with chill and 3 permanent moulds),
- horizontal – 3 sand moulds with horizontal chill.

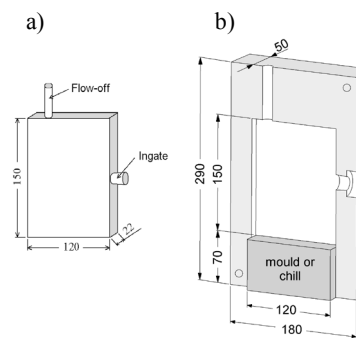

Fig. 1. Dimensions: a) casting used in experiments, b) half of the mould

Conditions of alloy casting solidification were described with cooling rate ($R = \Delta T / \Delta t$, $^\circ\text{C/s}$), determined from self-cooling curves for the range of the $\alpha + (\alpha + \text{Si})$ phase growth – fig. 2 – in locations shown in the fig. 3a.

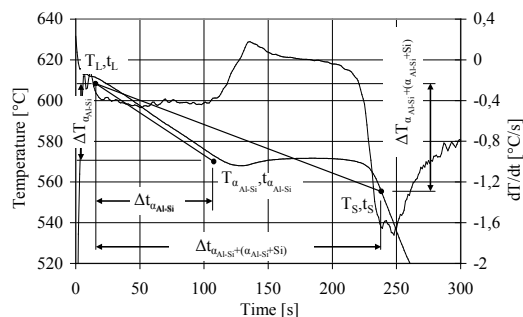

Fig. 2. Method of determining the R value in period of $\alpha + (\alpha + \text{Si})$ phase growth [15], where: T_L , T_S – respectively temperature of liquidus, temperature of end of $\alpha + \text{eut}(\alpha + \text{Si})$ phase solidification, t_L , t_S – respectively time of reaching the liquidus temperature and temperature of end of $\alpha + \text{eut}(\alpha + \text{Si})$ phase solidification

Measurements of temperature for determining the cooling curves were performed using mantle thermocouples NiCr-Ni of 1 mm diameter with additional shield of chrome-nickel steel with 1,7 mm in diameter. Results of temperature measurements were registered on the EURO THERM type 5100 V recorder.

Changing thermal conditions in the casting are a reason of changes in microstructure refinement and volume fraction of porosity. Refinement of α solid solution was described using

an indirect parameter, i.e. average distance between last arms of well developed dendrite parts (at least 4 arms) observed in the microstructure (DASL).

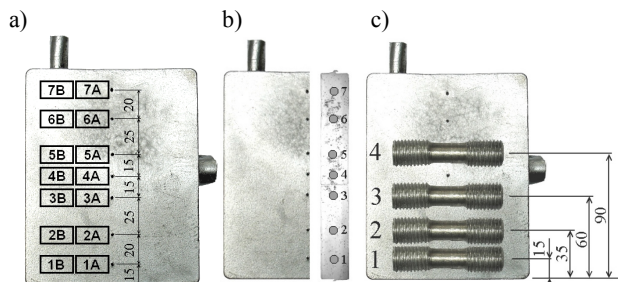

Fig. 3. Locations of temperature measurement and sample cutting for study of the porosity fraction and of sample cutting for: b) structure refinement study, c) mechanical properties study

Eutectic cells refinement (branched spherical silicon skeleton) was described with the greatest lengths of silicon precipitations observed on the microsection in analyzed locations, assuming that this value roughly equals to the cell diameter.

Observations of microstructure and measurements of its geometrical parameters were performed using a polished metallographic specimen, near locations of thermocouple placing (fig. 3b), with the optical NIKON microscope and software for image analysis – ImageJ 1.42q. Checking the chemical constitution of intermetallic phases in the structure was carried out using scanning electron microscope with variable vacuum – Vega Tescan 5135 (the following detectors were used: SE – Secondary Elektron, BSE – BackScattered Elektron), equipped with a system for micro X-ray analysis. Samples for examination were etched with 10% NaOH in time of 5 minutes.

Fraction of porosity was determined basing on measurements of density of individual specimens cut from the casting of the plate in locations shown in the fig. 3a. Surfaces of the samples of dimensions 23x14x12mm were polished with water abrasive paper of granularity 800.

Volume fraction of porosity was calculated using the following equation:

$$\text{Por} = [1 - (\rho_r / \rho_t)] 100, \% \quad (1)$$

where: ρ_r – real density, ρ_t – theoretical density

Theoretical density was calculated considering densities and fractions of particular elements in the studied alloy, while experimental density was determined using laboratory weigher RADWAG with additional module for density study.

Study of mechanical properties: tensile strength, yield strength and elongation were conducted on non-standard samples with measured part dimensions of $\phi 10 \times 10$ mm (samples were cut out of the plate – fig. 3c), using the INSTRON 4483 device. Velocity of stress increase was 10 MPa/s.

The methodology signalized above was elaborated on the base of study presented in [5]. Confirmation of the effectiveness of this methodology and its extensions is described in [17].

3. Study results and analysis

On the basis of the cooling curves (fig. 4) obtained from the temperature measurements in specific locations on the plate casting, shown in the fig. 3a, R values were determined for the

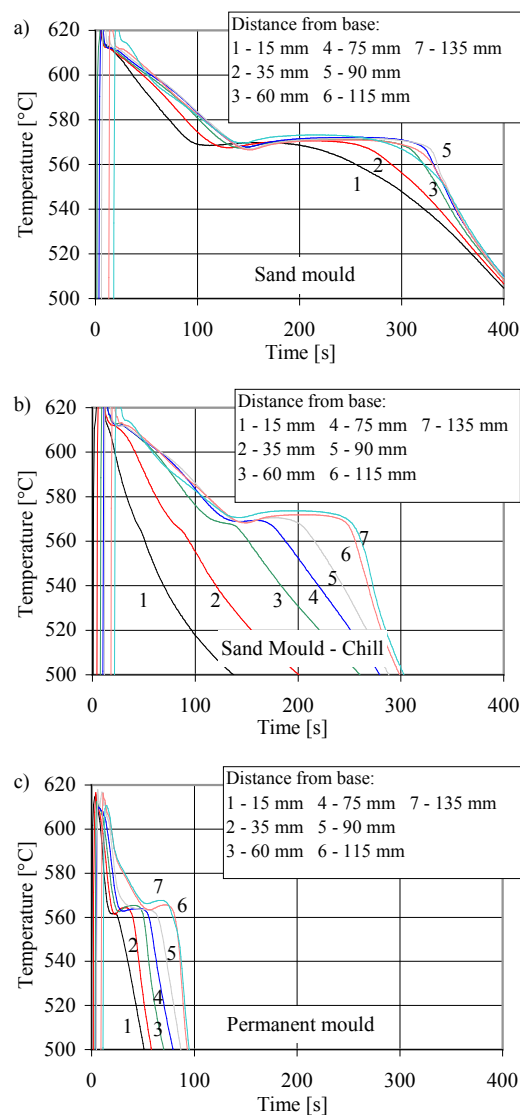

Fig. 4. Cooling curves of the plate casting, made in: a) sand mould, b) sand mould with chill, c) permanent mould

period of α + eutectic mixture (α +Si) phase growth. Change of R values as a function of distance from the base of the cast plate made in moulds of different cooling capabilities (P, PO, K) is presented in the fig. 5.

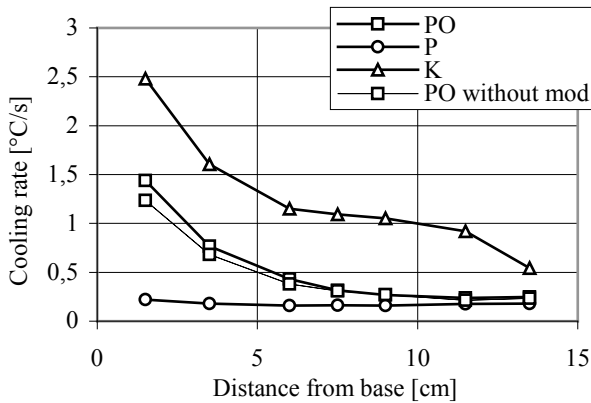

Fig. 5. Change of cooling rate as a function of distance from the plate base

Results of α solid solution refinement study (DASL), as a function of distance from the base of the cast plate, made in examined moulds are shown in the fig. 6 and as a function of R values in the fig. 7. Eutectic mixture refinement – length of silicon precipitations (DISi) as a function of distance from the base of the plate is presented in the fig. 8 and as a function of R – in the fig. 9. Refinement of the solid solution α and silicon in the eutectic is illustrated with an example of 35 mm from the base of the plate, in the fig. 10.

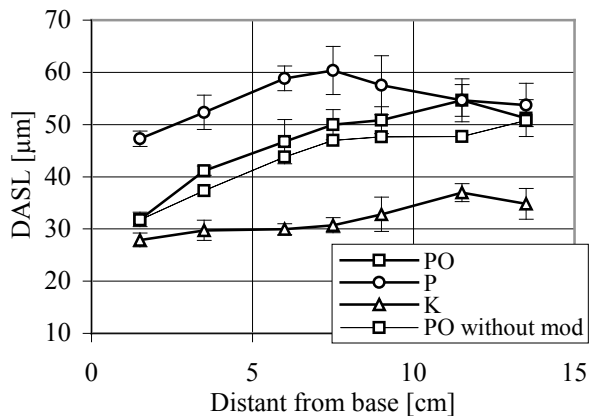

Fig. 6. Change of distance between arms in dendrites as a function of distance from the plate base

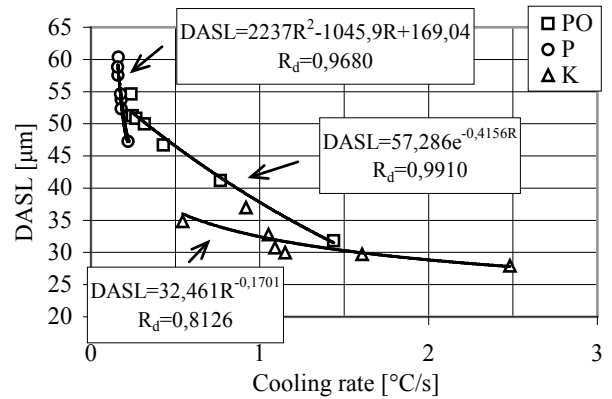

Fig. 7. Change of distance between arms in dendrites as a function of cooling rate

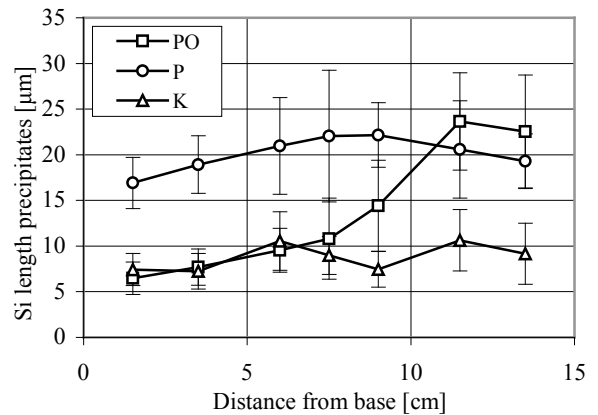

Fig. 8. Change of length of the eutectic silicon precipitations as a function of distance from the plate base

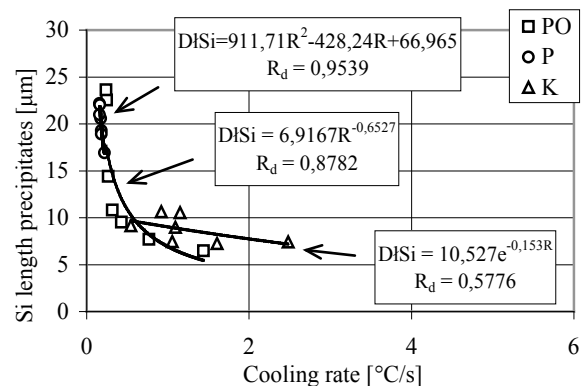

Fig. 9. Change of length of the eutectic silicon precipitations as a function of cooling rate

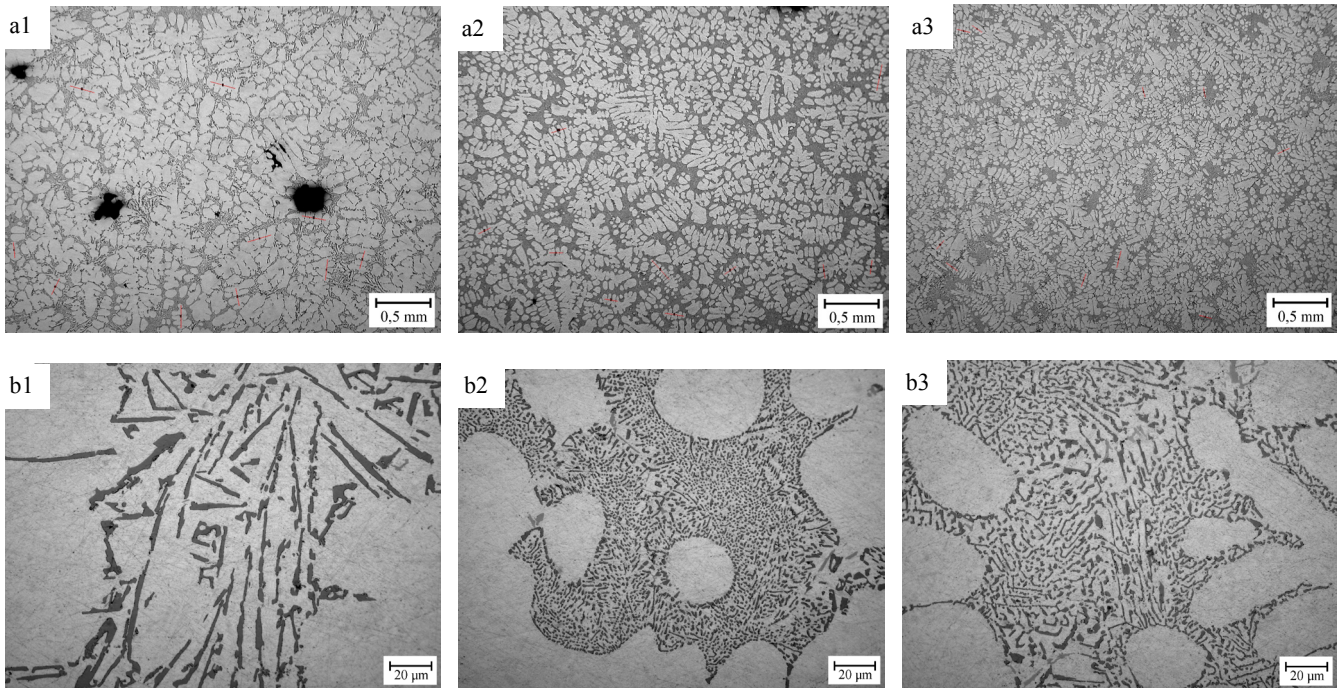

Fig.10. Structure of the main phases in the casting: a) dendrites of the α solid solution, b) eutectic (α +Si) from various moulds: 1-P, 2-PO, 3-K

Results of study of the porosity volume fraction (Por) as a function of distance from the base of the plate casting are presented in the fig. 11 for the central – A – area of the plate (check fig. 3a). Change of porosity fraction as a function of R is shown in the fig. 12.

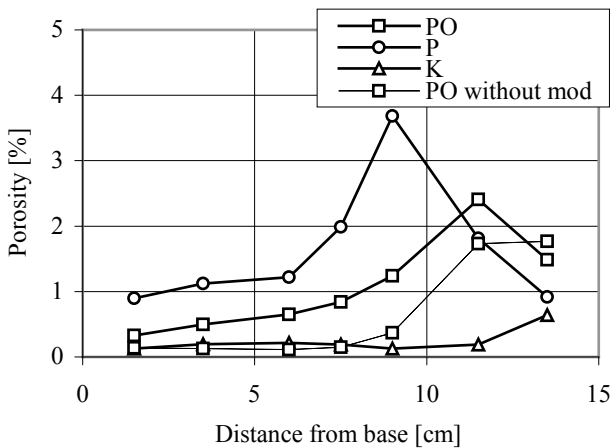

Fig. 11. Change of porosity fraction as a function of distance from the plate base, central area of the plate – A,

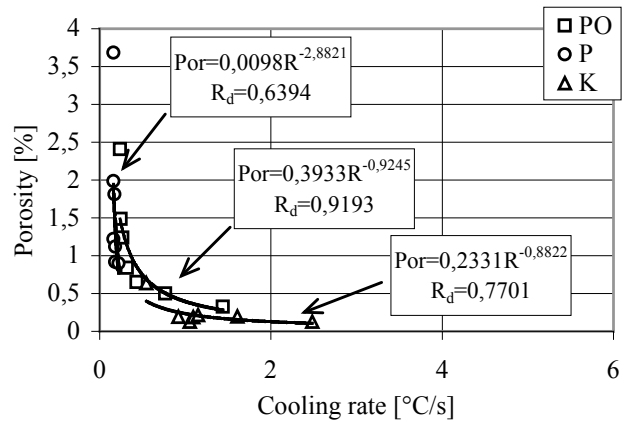

Fig. 12. Change of the porosity fraction in the A area of the casting as a function of R

Illustration of the porosity in castings of the modified alloy from studied moulds and, comparatively, of the unmodified alloy out of PO mould [15] is presented in the fig. 13. Fraction of gas-shrinkage porosity on the surface is lower in the casting out of the non-modified alloy, in comparison with the modified alloy.

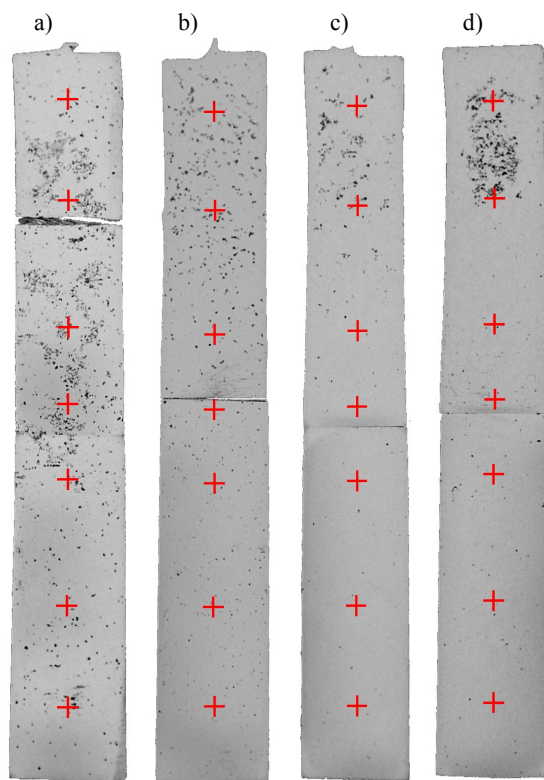

Fig. 13. Porosity on a section of wall of plate casting from different moulds: a) P, b) PO, c) PO unmodified alloy, d) K

In the examined locations of the sand mould casting, as a result of cooling rate reduction $0,22 \div 0,17$ °C/s, there was an increase in values: DASL $47 \div 60$ µm, DISi $17 \div 22$ µm and Por. $0,9 \div 3,7$ %. Application of chill in the sand mould increased range of cooling rate values: $1,45 \div 0,24$ °C/s, which changed the ranges values: DASL $32 \div 55$ µm, DISi $2 \div 24$ µm and Por. $0,4 \div 2,4$ %. The permanent mould casting solidified in a cooling rate range of $2,5 \div 0,55$ °C/s and range values of the parameters variability are: DASL $28 \div 36$ µm, DISi $7 \div 10$ µm and Por. $0,1 \div 0,7$ %.

Relations describing changes in distance between branches in dendrites, length of silicon precipitations and fraction of porosity as a function of cooling rate of castings in a particular mould are presented in the fig. 7, 9 and 12. Relations of mentioned structure parameters as a function of cooling rate from various sets of examined moulds are also important. Relations of these parameters as a function of R for a set of castings from 3 moulds are presented in the fig. 14, correlation coefficient are higher than 0,9.

Shrinkage porosity fraction is also dependent on the other components of the alloy, which form eutectic of lower fusibility than eutectic (α +Si), because during crystallization its are isolated from the feeding. Examination using scanning electron microscope with an X-ray probe has proven that the following phases are present in the structure: β -Al₅FeSi, π -Al₈Si₆Mg₃Fe i Mg₂Si (fig.15).

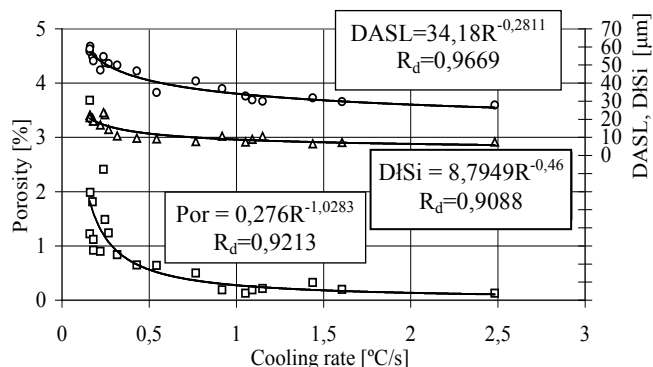

Fig. 14. Change of Por, DASL, DISi as a function of R in castings of sets of P+PO+K moulds

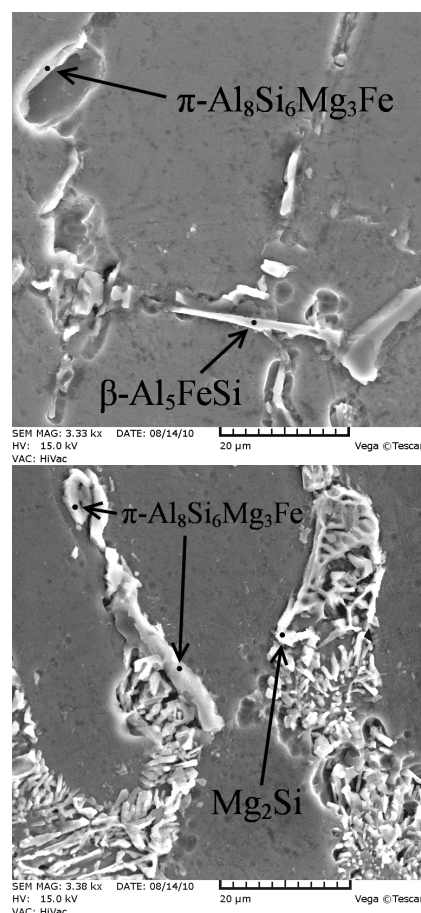

Fig. 15. Intermetallic phases in multi-component eutectic

Results of mechanical properties examination (average from the 4 samples): tensile strength, yield strength and elongation are presented in the fig. 18. Range of variability of mechanical properties of the plate castings made out of the AlSi7Mg0,3 alloy, solidifying in moulds used during the research is wide and equals as following: $R_m = 71 \div 190$ MPa, $R_{0,2} = 59 \div 87$ MPa, $A_1 = 2,5 \div 22$ %.

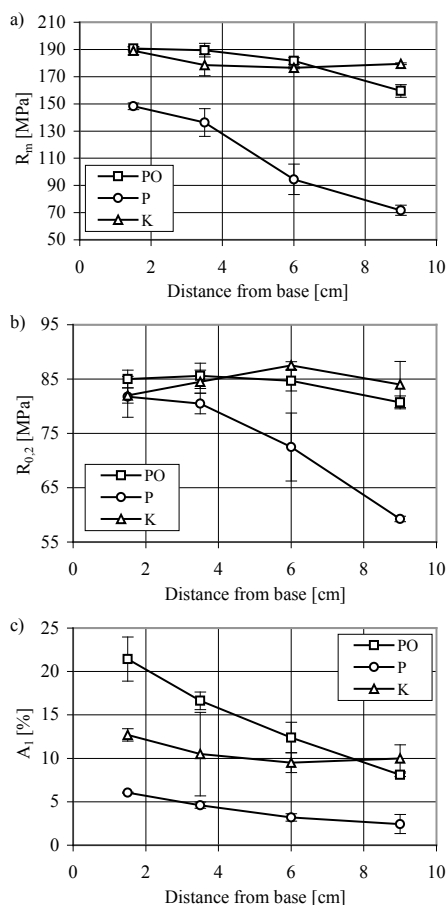

Fig. 16. Mechanical properties of alloy as a function of distance from the plate base: a) tensile strength, b) yield strength, c) elongation

Influence of the structure refinement and the porosity fraction in the sample from the casting from the horizontal sand mould with chill in lower half of the mould, loaded with a bending force was also studied. Two position options were examined: 1 – tensile stress in the casting part from the chill side (DASL=20,2 μm , Por=0,3%) and 2 – tensile stress in the casting part from the moulding sand side (DASL=43,2 μm , Por=0,7%).

Cyclic pulsating load with 13 kN force value and 20 Hz frequency was applied. The sample with $b \times h = 25 \times 17$ mm cross

section, the distance between the supports 100 mm what gives the stress load equal to $\sigma_g = 312,5$ MPa. Option 1 sample with lower value parameters of the structure endured $1,6 \times 10^6$ pulsating bending load cycles and option 2 sample with greater value parameters of the structure endured $0,96 \times 10^6$ pulsating load cycles. Results obtained from the work were used to develop statistical relationships of the porosity fraction, distance between arms in dendrites and silicon precipitations in an eutectic mixture as a function of cooling rate, which were put in the table 1. The results were also used to create multi-parameter relations between the mechanical properties (R_m , $R_{0,2}$, A_1) and refinement of solid solution α , silicon refinement in an eutectic mixture and the fraction of porosity, using multiple regression method. Table 2 presents these relations. They were prepared for castings from different sets of moulds.

Developed relations are helpful for prediction of mechanical properties during design of a casting and conception of its production technology.

Table 1.

Equations describing structure as a function of cooling rate in the moulds

Castings from the moulds	Equations	Correlation coefficient R_d
P	Por = $0,01R^{-2,88}$	0,64
	DASL = $2237R^2 - 1045,9R + 169$	0,97
	DISi = $911,7R^2 - 428,2R + 67$	0,95
PO	Por = $0,39R^{-0,92}$	0,92
	DASL = $57,3e^{-0,42R}$	0,99
	DISi = $6,9R^{-0,65}$	0,88
K	Por = $0,23R^{-0,88}$	0,77
	DASL = $32,5R^{-0,17}$	0,81
	DISi = $10,5e^{-0,15R}$	0,58
P+PO+K	Por = $0,28R^{-1,03}$	0,92
	DASL = $34,2R^{-0,28}$	0,97
	DISi = $8,8R^{-0,46}$	0,91
P+PO	Por = $0,41R^{-0,79}$	0,81
	DASL = $36,6R^{-0,24}$	0,95
	DISi = $7R^{-0,62}$	0,92
P+K	Por = $0,24R^{-1,04}$	0,94
	DASL = $33,3R^{-0,28}$	0,97
	DISi = $9,4R^{-0,42}$	0,96
Por - %, DASL, DISi - μm , R - $^\circ\text{C/s}$		

Table 2.

Mathematical relations describing mechanical properties of castings from different mould sets

Castings from the moulds	Equations	Correlation coefficient, R_d
R_m	P+PO+K: $R_m = 213,1 - 14,3 \text{ Por} + 0,55 \text{ DASL} - 5,3 \text{ DISi}$	0,96
	P+PO: $R_m = 237,6 - 14,1 \text{ Por} - 0,02 \text{ DASL} - 5,0 \text{ DISi}$	0,97
	P+K: $R_m = 247,1 - 16,6 \text{ Por} - 2,24 \text{ DASL} + 0,68 \text{ DISi}$	0,98
$R_{0,2}$	P+PO+K: $R_{0,2} = 84,8 - 7,0 \text{ Por} + 0,15 \text{ DASL} - 0,40 \text{ DISi}$	0,94
	P+PO: $R_{0,2} = 90,7 - 6,8 \text{ Por} + 0,02 \text{ DASL} - 0,34 \text{ DISi}$	0,97
	P+K: $R_{0,2} = 93,3 - 7,6 \text{ Por} - 0,58 \text{ DASL} + 1,2 \text{ DISi}$	0,97
A_1	P+PO+K: $A_1 = 16,8 + 0,75 \text{ Por} + 0,18 \text{ DASL} - 1,3 \text{ DISi}$	0,88
	P+PO: $A_1 = 35,4 + 0,61 \text{ Por} - 0,34 \text{ DASL} - 0,72 \text{ DISi}$	0,98
	P+K: $A_1 = 17,3 - 0,24 \text{ Por} - 0,16 \text{ DASL} - 0,22 \text{ DISi}$	0,98
Por – porosity fraction in %, DASL, DISi - μm , R_m , $R_{0,2}$ - MPa, A_1 in %		

The tests using mechanical simulation systems (Ansys, Comsol) have shown how the properties gradient influences on the safety factor distribution in the casting subjected by chosen load. The tolerance of damage principle was developed and described in [18]. The feasibility of that kind of way on the example of simple shape casting made of AlSi7Mg0,3 alloy with the structure and properties gradient especially created were analyzed.

4. Conclusions

On the basis of the conducted studies and analyses of results obtained the following conclusions can be drawn:

1. Mechanical properties of castings made out of a certain alloy are dependent on several structure parameters. The main structure parameters that need to be considered in the hypoeutectic silumin castings are: distance between arms in α phase dendrites, length of silicon precipitations in eutectic and porosity fraction.
2. Change of porosity fraction in a range of 0,12 to 3,7% has a significant influence on the mechanical properties and is substantially dependent on the cooling rate.

Acknowledgement

The research presented in the paper was partially realized during research grant No. N N507 420636, financed by Polish Ministry of Science and Higher Education.

References

- [1] Caceras, C.H. et al. (1999). The Effect of Cu Constant on the Level of Microporosity in Al-Si-Cu-Mg Casting Alloys. *Scripta Materialia*. 40 (5), 631-637.
- [2] Dash, M. & Makhlof M. (2001). Effect of key alloying elements on the feeding characteristics of aluminum-silicon casting alloys. *Journal of Light Metals*. 1, 251-265.
- [3] Jaquet, J.C. & Hotz, W. (1992). Quantitative Description of the Microstructure of Aluminum Foundry Alloys. *Cast Metals*. 4 (4), 200-225.
- [4] Tensi, H.M. & Högerl J. (1994). Metallographic investigation of microstructure for quality assurance of AlSi-castings. *Metall*. 48 (10), 776-781 (in German).
- [5] Hajkowski, M. (2003). *Forecasting of mechanical properties of the casting made of hypoeutectic silumins on the basis of thermal processes and structural parameters*. Monograph. Publishing House of Poznan University of Technology, Poznań (in Polish).
- [6] Bosi, C., Gragnani G.L. & Tovo, R. (2002). Fatigue Properties of a Cast Aluminium Alloy for Rims of Cars Wheels. *Metallurgical Science and Technology*. 20 (1), 3-8.
- [7] Jácome, P.A.D. et al. (2011). The application of computational thermodynamics and a numerical model for the determination of surface tension and Gibbs-Thomson coefficient of aluminum based alloys. *Thermochimica Acta*. 523, 142-149.
- [8] Irfan, M.A. et al. (2012). Porosity reduction and mechanical properties improvement in die cast engine blocks. *Materials Science and Engineering A*. 535, 108-114.
- [9] Fang, Q.T. & Granger, D.A. (1989). Porosity formation in modified and unmodified A356 alloy castings, *AFS Transactions*. 97, 989-1000.
- [10] Bernat, Ł. & Hajkowski, M. (2010). The porosity of silumin casting solidifying in moulds with various thermal conditions. Chapter in monograph Pietrowski S. (eds.) Optimization trends of the production system in foundries (pp. 7-20). Katowice – Gliwice. Published by Polish Academy of Science, Commission of Foundry Engineering. (in Polish).
- [11] Shabestari, S.G. & Shahri F. (2004). Influence of modification solidification conditions and heat treatment on the microstructure and mechanical properties of A356 aluminum alloy. *Journal of Materials Science*. 39, 2023-2032.
- [12] Ferri, T.V. et al. (2010). Mechanical properties as a function of microstructure in the new Mg-Al-Ca-La alloy solidified under different conditions. *Materials Science and Engineering A*. 527, 4624-4632.
- [13] Hengcheng Liao, Yu Sun, Guoxiong Sun (2002). Correlation between mechanical properties and amount of dendritic α -Al phase in as-cast near-eutectic Al-11.6% Si alloys modified with strontium. *Materials Science and Engineering*. 335, 62-66.
- [14] Pietrowski, S. (2002). Casting of silumin car wheels. *Archives of Foundry*. 2, 210-221 (in Polish).
- [15] Bernat, Ł. (2011). Porosity influence on the mechanical properties of hypoeutectic silumin castings. PhD dissertation, Poznan University of Technology (in Polish).
- [16] Campbell, J. & Harding R.A. (1994). Solidification Defects in Castings. *TALAT Lecture 3207*, University of Birmingham.
- [17] Ignaszak, Z., Hajkowski, J. & Hajkowski, M. (2010). Sensitivity testing practice on pre-processing parameters in hard and soft coupled modeling. *Archives of Foundry Engineering*. 1 (10), 51-58.
- [18] Ignaszak, Z., Popielarski, P., Hajkowski, J. & Prunier J.B. (2012). Problem of acceptability of internal porosity in semi-finished cast product as new trend – “tolerance of damage” present in modern design office. *Defect and Diffusion Forum*. 326-328, 612-619.