

Broadband Input Block of Radio Receiver for Software-Defined Radio Devices

Miroslaw Magnuski, Maciej Surma, and Dariusz Wójcik

Abstract—In the paper a cost-effective input block of the SDR receiver for 0.9 – 2.4GHz frequency band built of capacitive-tuned selective amplifier and broadband Vivaldi antenna is presented. The applied selective amplifier consists of three identical sections of tunable filters and two stages of monolithic broadband amplifiers. The single filter section proposed by the authors, due to its ability to absorb parasitic inductances of varicap diodes, simplifies usage of encapsulated varicap diodes in design of tunable in broad band selective filters dedicated to input stages of the receivers. Moreover, proposed filter section has small variation of in-band insertion loss in comparison to varicap-tuned filters built of coupled transmission lines which are commonly applied in input blocks of the microwave receivers. The described selective amplifier could be easily integrated on a single substrate with the Vivaldi antenna which is a cost effective way of fabrication of the tunable in broad band input block of a receiver that has desired gain, selectivity and directivity of the antenna.

Keywords—software-defined radio, radio receiver, broadband antenna, tuned filter

I. INTRODUCTION

NOWADAYS we can observe trends in development of the RF systems and circuits towards increasing their universality by means of their ability to flexible operation in various frequency bands and with numerous modulations. These aims are achieved due to application of configurable RF circuitry which properties are programmable. Requirements of the reconfigurability are imposed on devices built in the SDR technology [1], [2]. RF devices built in the SDR technology have many of their essential functions, that have been realized so far by analog blocks, such as filtration, modulation, demodulation or signal conditioning realized as effects of algorithms implemented on signal processors or PLD circuits [3]. Therefore some properties of the SDR devices could be easily changed or modified without any circuitry modifications. Ability of reconfiguration of the RF devices without recomposition of their circuitry is the aim of the contemporary RF engineering. However in the RF and microwave SDR devices DSP blocks cooperate with programmable high frequency analog blocks realizing frequency conversion, preselection or filtration and amplification [4]. One of the issues solved in designing of the reconfigurable, tunable in broad band receivers is construction of their antennas and input blocks. Application of the SDR technology simplified construction of single-band tuned receivers which properties such as operating frequency band and selectivity are determined by means of input filter having appropriate electric

All the authors are with the Faculty of Automatic Control, Electronics and Computer Science, Silesian University of Technology, Gliwice, Poland (e-mails: mmagnuski@polsl.pl, msurma@polsl.pl, dwojcik@polsl.pl).

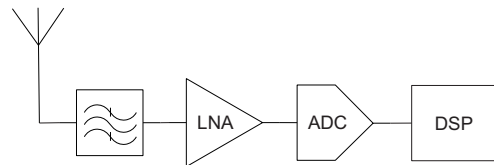

Fig. 1. Simplified block diagram of a single-band SDR receiver

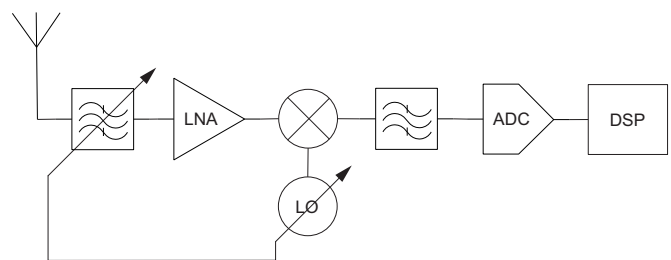

Fig. 2. Simplified block diagram of a broadband SDR receiver

parameters (see Fig. 1). In the tuned in broad band microwave SDR receivers (see Fig. 2) achievement of desired selectivity and dynamics range is related to application of analog signal processing blocks in their front-ends and SDR technology in their IF blocks [5]. In the tuned in broad band microwave SDR receivers, where technique of down-conversion is applied, rejection of image channel could be obtained by application of the tuned input filter. Cost effective tuned input filters are capacitive-tuned devices that utilize varicap diodes as voltage tuned capacitors [6].

In the paper an input block of the receiver consisted of a varicap-tuned selective amplifier and an ultra broadband antenna is presented. Described blocks are designed as parts of the front-end of the SDR receiver, and could be integrated together on a single substrate [7]. Integration of the broadband antenna and tunable input amplifier is a cost effective way of fabrication of the tunable in broad band input block of a microwave receiver that has desired gain, selectivity and directivity of the antenna [8].

II. ELEMENTARY SECTION OF INPUT FILTER

Presently as the tunable filters in input blocks of the RF and microwave receivers filter sections built of resonators made of coupled transmissions lines are commonly applied. In those kind of filters their center frequency is tuned by means of the varicap diodes which capacitance modifies electrical length of resonators. In case of microwave varicap-tuned filters built of the resonators having small equivalent inductances it is

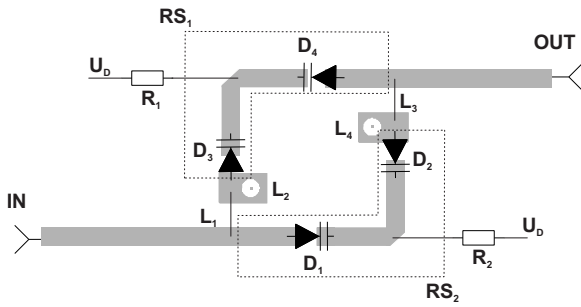

Fig. 3. Printed circuit board with element placement of the single filter block

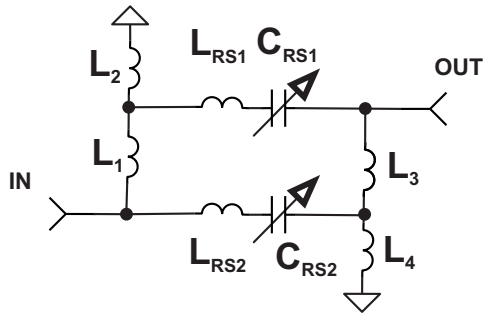

Fig. 4. Simplified schematic diagram of the single filter block

a problem with choice of the suitable varicap diodes which have small lead inductances and appropriate tuning ratio. Other problem existing during tunable filter design is achievement of small in-band insertion loss variation during filter tuning process.

Construction of broadband tunable filter that utilizes encapsulated varicap diodes for application as input filter of a receiver, it is the issue connected with choice of such filter structure that is able to absorb parasitic inductances of the diodes and that has possible small in-band attenuation. Input filter of the receiver that utilize downconversion technique and which has image channel at the frequency lying under operating channel, should have high rejection at frequencies which are lower than its operating frequency. Attenuation at frequencies higher than filter operating frequency is in this case uncritical.

The filter section which satisfies demands described above is depicted in Fig. 3 and Fig. 4 where the printed circuit board and schematic diagram of the filter are presented, respectively. The main elements of the filter are two resonators RS_1 , RS_2 . Each resonator is built of two connected in series varicap diodes and short sections of microstrip lines. The filter operating frequency is tuned by means of the control voltage U_D applied to the diode pairs through R_1 and R_2 resistors. Equivalent capacitance of the resonators is equal to capacitance of connected in series varicap diodes, equivalent inductance of the resonators is equal to connected in series lead inductances of the diodes and inductance of the interconnections within the resonators. Coupling between resonators of the filter is inductive by means of inductors L_1 , L_2 and L_3 , L_4 .

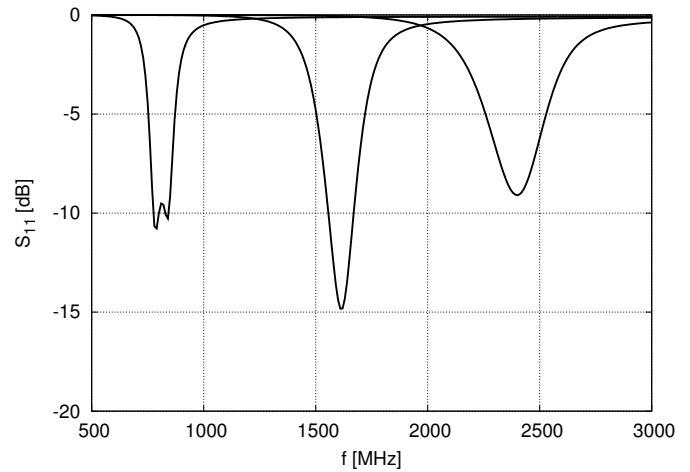

Fig. 5. Reflection coefficient of the single filter block for three centre frequencies. Results obtained from simulation by Microwave Office.

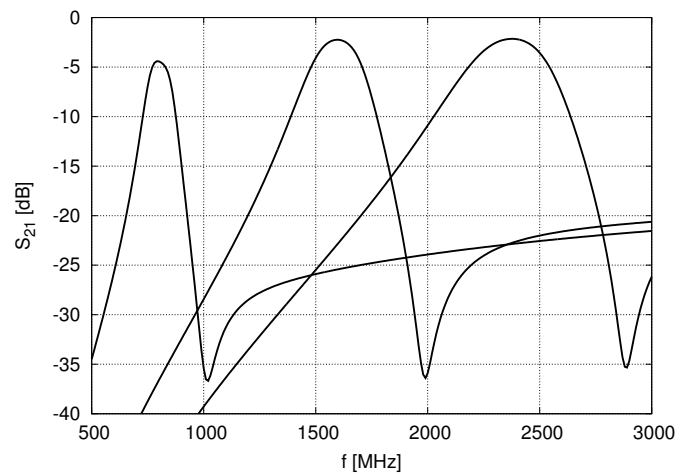

Fig. 6. Transmission coefficient of the single filter block for three centre frequencies. Results obtained from simulation by Microwave Office.

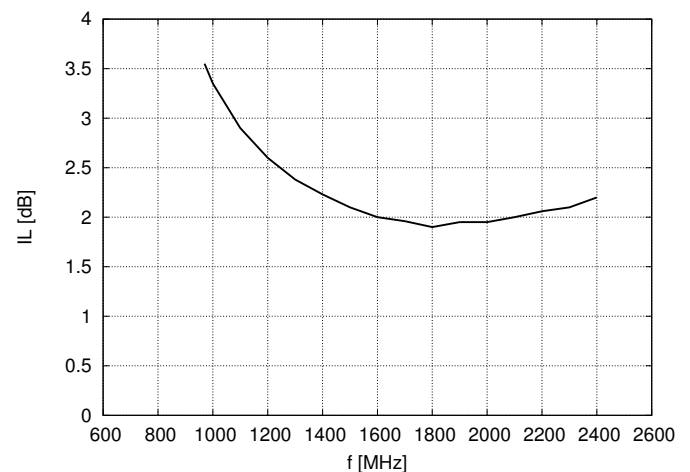

Fig. 7. Simulated insertion loss of the filter versus frequency

The filter behavior in frequency range 0.5 – 3GHz has been investigated by simulation performed with Microwave Office software. For the filter realization varicap diodes 1SV280 have been chosen. The diodes have operating frequency up to

3GHz, capacitance ratio $C(2V)/C(10V)=2.4$, lead inductance 0.5nH and series resistance 0.44Ω. According to simulations, achievement of optimal coupling between resonators leading to good matching of the filter and small variations of its insertion loss in filter tuning process demands that inductors L_1, L_3 and L_2, L_3 should be equal to 1.5nH and 0.3nH, respectively. To achieve appropriate values of inductances L_2 and L_4 , they are fabricated as vias of 0.15mm diameter and 0.7mm high. The inductances L_1 and L_3 are made as short piece of wires of 2mm length.

Behavior of the scattering parameters of the filter section versus frequency is presented for the center frequencies 0.8GHz, 1.6GHz and 2.4GHz in Fig. 5 and 6. Tuning of the capacitance of the varicap diodes from 5.5pF to 0.3pF, approximately, leads to change of filter center frequency from 0.8GHz to 2.4GHz. From S_{21} characteristics the 3dB filter bandwidth varies from 60MHz to 180MHz, accordingly. As it could be noticed from the Fig. 6, propitious upper slope of S_{21} is achieved due to existence of the attenuation pole placed over the center frequency of the filter. Within operating bandwidth, S_{11} is better than -6dB for the whole tuning range and better than -10dB for frequencies from 1.1GHz to 2.23GHz. The values of simulated insertion loss of the filter, shown in Fig. 7, vary from 1.8dB to 3.5dB.

III. REALIZATION OF TUNED SELECTIVE AMPLIFIER

The section of the described bandpass filter has been applied in construction of a tunable selective amplifier dedicated for RF input block of SDR receiver. As it is presented in Fig. 8 the amplifier consists of three identical sections of tunable filters and two stages of monolithic broadband amplifiers ERA1SM. Applied amplifiers have bandwidth of 8GHz and S_{21} of 12dB each.

The practical implementation of the selective amplifier is presented in Fig. 9. The printed circuit board has been

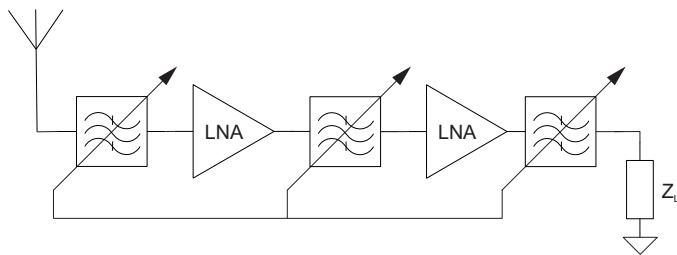

Fig. 8. Block diagram of the tuned selective amplifier

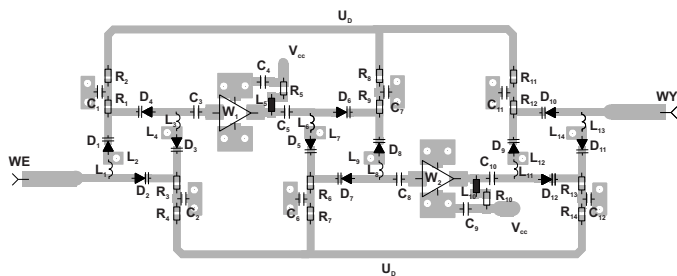

Fig. 9. PCB of the selective amplifier with element placement

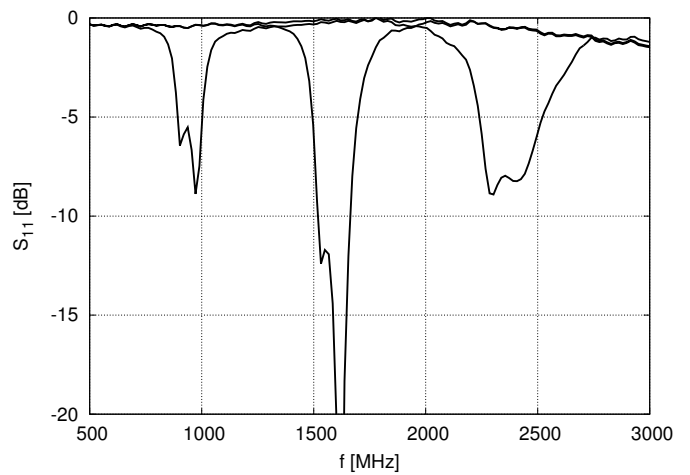

Fig. 10. Measured S_{11} coefficient of the tunable selective amplifier for three selected values of control voltage

fabricated by the authors in 'home-made' way on 0.03 inch thick ARLON AD450 substrate of relative permittivity 4.5 and loss tangent of 0.003. Parameters of the fabricated filter circuit have been measured with the vector network analyzer Agilent N5230A equipped with calibration kit 85052D. The scattering parameters versus frequency are presented in Fig. 10–13. S_{11} parameter measured for center frequency of the amplifier is for the majority of tuning band better than -10dB up to 2GHz and decreases to -6dB for 2.4GHz. S_{22} parameter is for the lowest tuning frequencies about -20dB and increases to -6dB for 2.4GHz. It seems to the authors that more precise fabrication of PCB could improve variations of scattering parameters of the amplifier. Center frequency versus voltage characteristic of the selective amplifier is shown in Fig. 14 and it is typical for the applied varicap diodes. Transducer power gain G_T and available power gain G_A of the amplifier are presented in Fig. 15. The G_T is of 12dB±2dB for center frequencies 900 – 2400MHz. The G_A value is for the lowest frequencies practically equal to G_T and greater by 1dB for the highest frequency. Bandwidth characteristics versus frequency of selective amplifier measured for three levels of attenuation (3dB, 6dB and 60dB) are presented in Fig. 16. Stop-band attenuation of the selective amplifier for frequencies lower than its center frequency is better than 60dB. Attenuation of 60dB is achieved for the highest center frequency of the filter at frequency offset of 600MHz. For the lowest center frequency of the filter the attenuation of 60dB is achieved at the offset of 300MHz. Stop-band attenuation better than 40dB is achieved for frequencies higher than center frequency of the amplifier. This property of the described amplifier makes possible rejection of the image channel better than 60dB in receivers working with down-conversion at frequency band 0.9 – 2.4GHz with IF frequency of 300MHz.

To investigate circuitry linearity, value of the third-order intercept point (IIP3) parameter has been measured. The measurements have been performed with a test set of two E4421B signal generators and FSV30 signal analyzer. As test signal a two-tone signal with 20MHz offset and -20dBm power level was applied. The results are presented in Fig. 17. In the

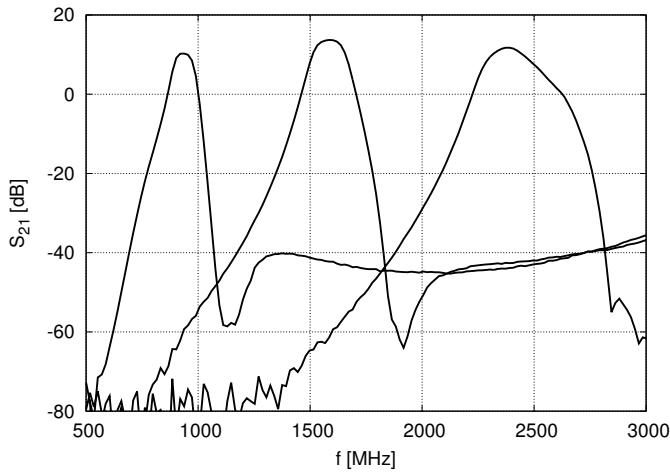

Fig. 11. Measured S_{21} coefficient of the tunable selective amplifier for three selected values of control voltage

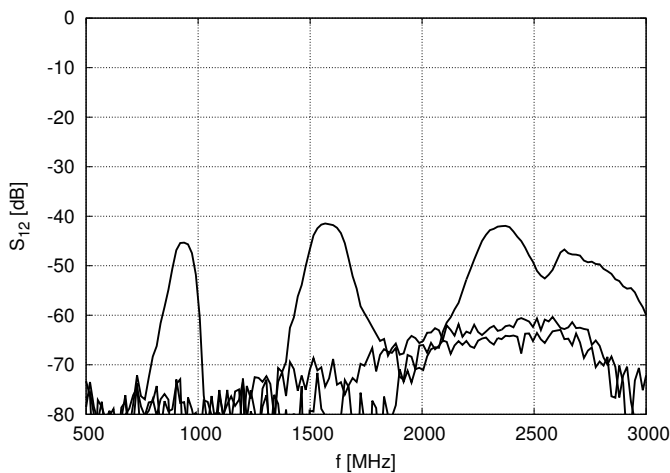

Fig. 12. Measured S_{12} coefficient of the tunable selective amplifier for three selected values of control voltage

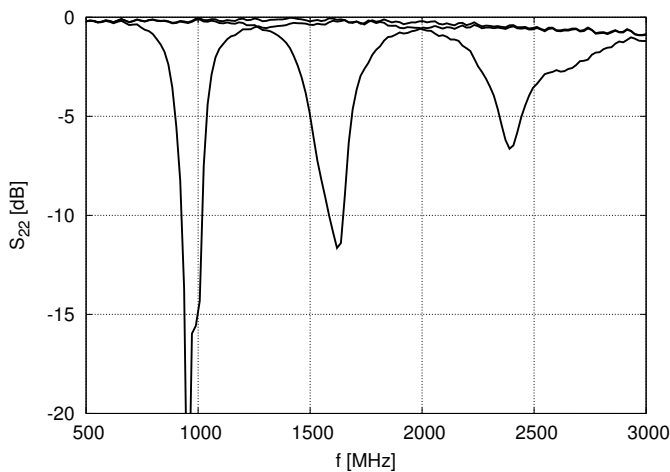

Fig. 13. Measured S_{22} coefficient of the tunable selective amplifier for three selected values of control voltage

frequency range from 1GHz to 2.4GHz, the IIP3 varies from 4.5dBm to 10dBm. For lower frequencies the IIP3 decreases due to lowering of varicap-tuning voltage.

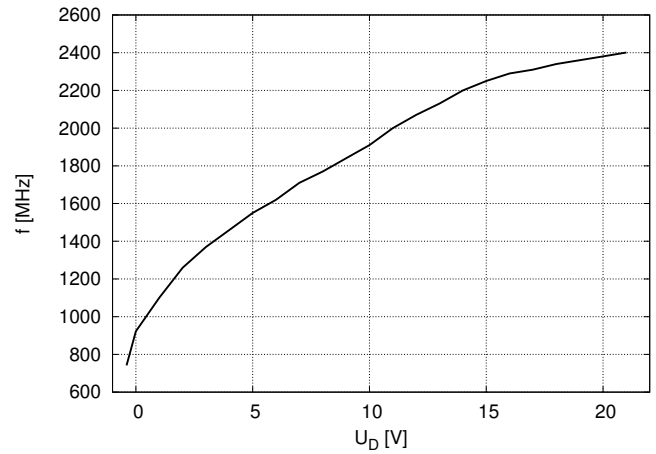

Fig. 14. Measured center frequency characteristic versus control voltage of the selective amplifier

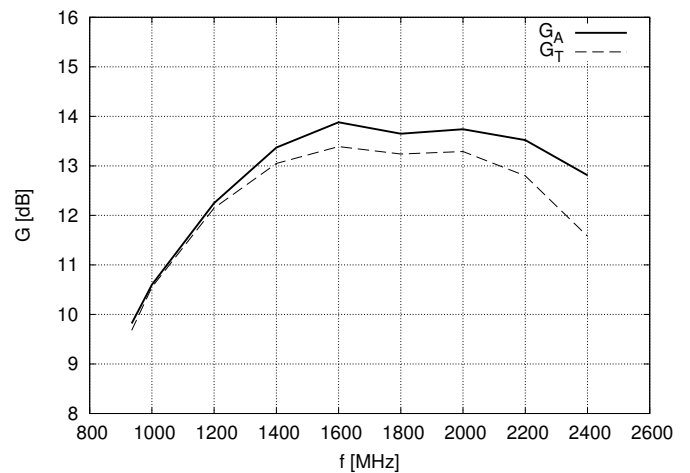

Fig. 15. Measured network gain versus frequency of the selective amplifier

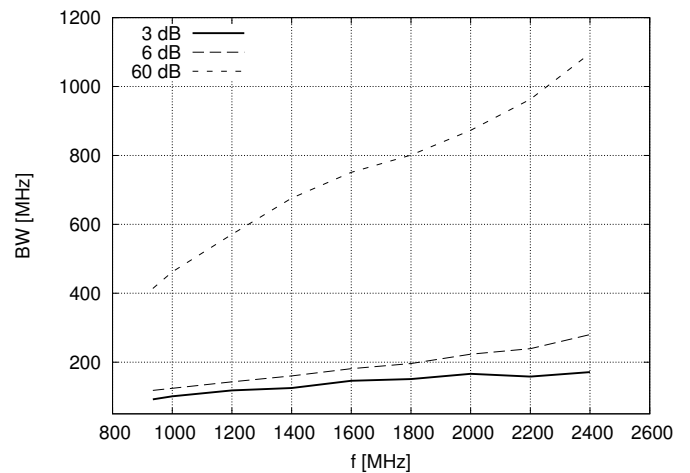

Fig. 16. Measured bandwidth versus frequency of the selective amplifier for three levels of attenuation

IV. COOPERATION WITH ULTRAWIDEBAND VIVALDI ANTENNA

The tuned selective amplifier, described in previous sections, has been connected to the broadband Vivaldi antenna forming

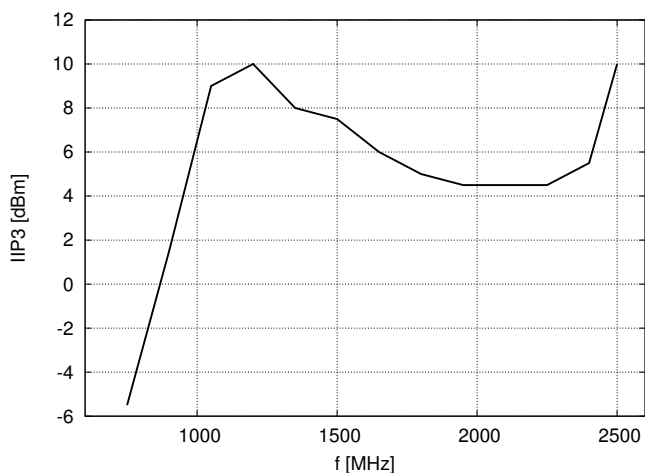

Fig. 17. IIP3 versus operating frequency of the tuned selective amplifier

an active receiving antenna system [9]. The structure of the antenna and its dimensions are shown in Fig. 18. The Vivaldi antenna is made up of two conducting leafs, forming a structure similar to the slot line, for which the separation between the conductors increases exponentially with the distance from excitation point. The antenna can be treated as a broadband impedance matching circuit between slot line feeder and free space. Dimensions of the antenna, in particular the length of the leafs, determine the lower frequency band. Upper frequency band limit depends mainly on the excitation method. The Vivaldi antenna is easy to manufacture in planar technology and can be easily integrated on the same substrate with the electrical circuit of the receiver.

The antenna is fed by 50Ω RG405U coaxial line of length 5cm. Inner conductor of the line is connected to one of the radiator of the antenna and its outer shield – to the other. Ferrite beads placed on the outside of the coaxial cable have been applied as a broadband balun. The excitation point of the antenna has been shifted by 5mm from its end in order to

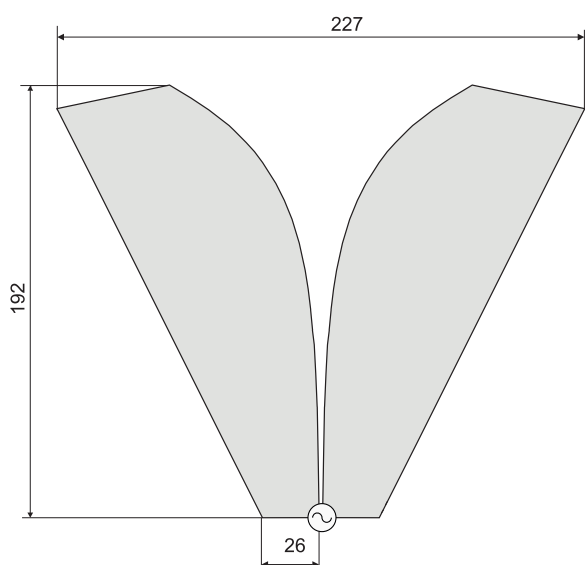

Fig. 18. Geometry of the applied Vivaldi antenna

compensate inductive character of the input impedance. The reflection coefficient Γ_A measured by network analyzer at the input of the coaxial line is presented in Fig. 19. As can be easily observed, Γ_A of the antenna is better than -10dB in $0.8 - 6\text{GHz}$ frequency band, which is absolutely sufficient for the application described in this article. The gain of the antenna versus frequency is presented in Fig. 20. The results have been obtained by simulations by using of CST Microwave Studio.

At this stage of the work the tuned amplifier and the Vivaldi antenna have been made on separate substrates and connected together via coaxial cable. The amount of available power collected by the separated receiving antenna and delivered to the matching load ($Z_L = Z_A^*$) is equal to [9]

$$P_A = A_{er} S = \frac{\lambda^2}{4\pi} G S = \frac{|U_A|^2}{4R_A} \quad (1)$$

where A_{er} is antenna effective area, S is power density of incident field, λ – wavelength, and U_A and R_A states for open circuit voltage of the antenna and real part of its input impedance, respectively. For antenna connected to the tuned selective amplifier, the available power of the active receiving antenna system is [10]

$$P_{LA} = G_A P_A = \frac{|S_{21}|^2 (1 - |\Gamma_A|^2)}{|1 - S_{11}\Gamma_A|^2 (1 - |\Gamma_{out}|^2)} \frac{\lambda^2}{4\pi} G \quad (2)$$

where

$$\Gamma_{out} = S_{22} + \frac{S_{12}S_{21}\Gamma_A}{1 - S_{11}\Gamma_A} \quad (3)$$

By comparison of equations (1) and (2) it can be easily observed that the active receiving antenna system behaves as receiving antenna for which the equivalent gain G_R is equal to

$$G_R = \frac{|S_{21}|^2 (1 - |\Gamma_A|^2)}{|1 - S_{11}\Gamma_A|^2 (1 - |\Gamma_{out}|^2)} G \quad (4)$$

In case of analysis of the tuned selective amplifier it can be assumed that $S_{12} \approx 0$ (see Fig. 12). Thus, (4) can be simplified into

$$G_R = \frac{|S_{21}|^2 (1 - |\Gamma_A|^2)}{|1 - S_{11}\Gamma_A|^2 (1 - |S_{22}|^2)} G \quad (5)$$

The equivalent gain versus frequency is shown in Fig. 21. As can be observed, the gain varies from about 13dBi for the lower frequency range of the system to 21dBi for frequencies close to 2GHz.

V. CONCLUSION

In the paper the input block consisting of the tuned selective amplifier and ultra broadband antenna dedicated to the SDR receiver is presented. Achieved tuning range is 1.5GHz from 0.9GHz to 2.4GHz. The prototype of the selective amplifier has been fabricated by the authors in 'home-made' way on 0.03 inch thick ARLON AD450 substrate. Parameters of the fabricated circuit have been verified by means of measurements. Measured transducer power gain G_T of the amplifier is of $12\text{dB} \pm 2\text{dB}$ for center frequencies 0.9 – 2.4GHz. For lower center frequencies G_T is better than 9dB. Characteristics of available power gain G_A are similar to G_T which proves good

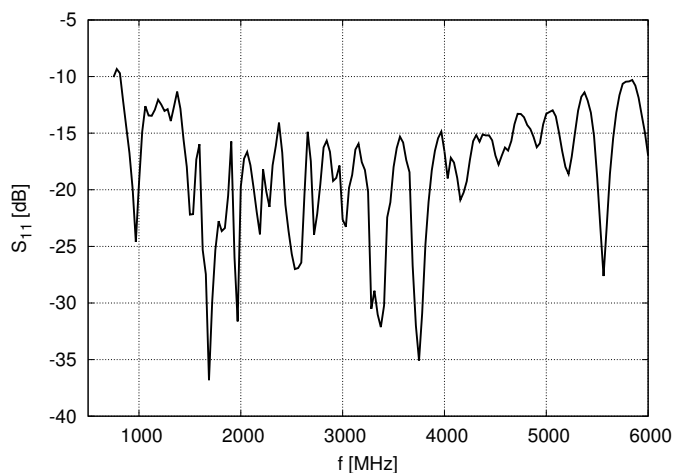

Fig. 19. Measured input reflection coefficient of the Vivaldi antenna

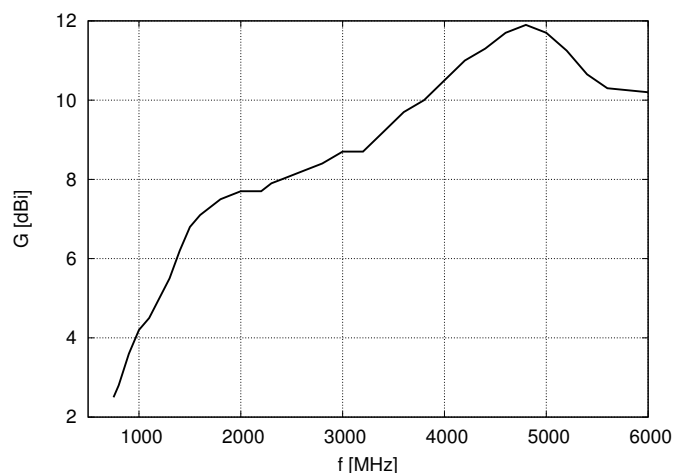

Fig. 20. Gain of the Vivaldi antenna

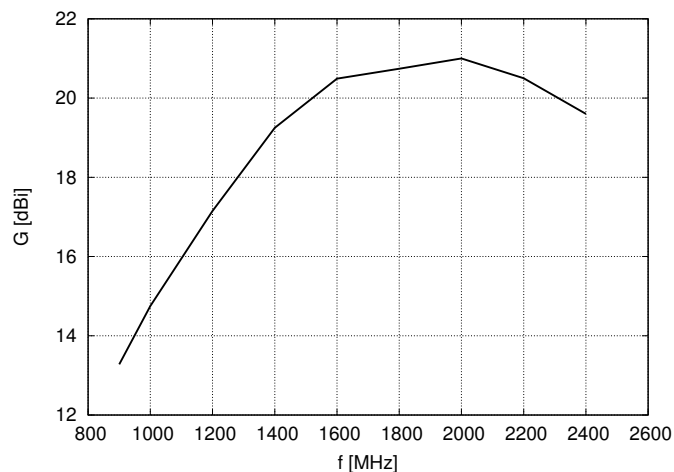

Fig. 21. Equivalent gain of the active receiving system built of the selective amplifier and the Vivaldi antenna

match conditions within the circuit. Stop-band attenuation of the selective amplifier for frequencies lower than its center frequency is better than 60dB for the offset of 600MHz. Maximum center frequency of the selective amplifier 2.4GHz is achieved for 23V of tuning voltage. Due to measurements, linearity of the amplifier is satisfactory. In the frequency range from 1GHz to 2.4GHz, the IIP3 varies from 4.5dBm to 10dBm.

The tuned selective amplifier has been connected to the broadband Vivaldi antenna forming an active receiving antenna system. At this stage of the work the tuned amplifier and the Vivaldi antenna have been fabricated on separate substrates and connected together via coaxial cable. Reflection coefficient of the antenna is better than -10dB in $0.8 - 6\text{GHz}$ frequency band, which is absolutely sufficient for the application described in this paper. The gain of the active receiving antenna system varies from about 13dBi for the lower frequency range of the system to 21dBi for frequencies close to 2GHz.

Integration of the broadband Vivaldi antenna and tunable amplifier designed by the authors seems to be a cost effective way of fabrication of a tunable in broad band input block of the SDR receiver and with supplement of mixer and local oscillator might be turned into a front-end stage.

REFERENCES

- [1] P. Burns, *Software Defined Radio for 3G*, Artech House, Boston-London, 1993.
- [2] P. B. Kenington, *RF and Baseband Techniques for Software Defined Radio*, Artech House, Boston-London, 2005.
- [3] T. J. Roupael, *RF and Digital Signal Processing for Software-Defined Radio. A Multi-Standard Multi-Mode Approach*, Elsevier, Oxford, 2009.
- [4] V. Giannini, J. Craninckx, and A. Baschirotto, *Baseband Analog Circuits for Software Defined Radio*, Springer, Dordrecht, 2008.
- [5] J. Mitola, *The software radio architecture*, IEEE Commun. Mag., vol. 33, pp.26 -38, 1995.
- [6] L. Huang and P. Russer, *Electrically tunable antenna design procedure for mobile applications*, IEEE Trans. Microw. Theory Techn., vol. 56, pp.2789 -2797, 2008.
- [7] M. Kallio, R. Valkonen, K. Stadius, and J. Ryynanen, *A 0.7-2.7GHz Blocker-Tolerant Compact-Size Single-Antenna Receiver for Wideband Mobile Applications*, IEEE Trans. Microw. Theory Techn, vol. 61, pp. 3339-3349, 2013.
- [8] P. S. Hall, P. Gardner, and A. Faraone, *Antenna requirements for software defined and cognitive radios*, Proc. IEEE, vol. 100, pp.2262 -2270, 2012.
- [9] J.D. Kraus, R.J. Marhefka, *Antennas for all Applications*, Mc-Graw Hill, New York, 2002.
- [10] D.M. Pozar, *Microwave Engineering*, John Wiley and Sons, New York, 1998.