

Sampling Rate Impact on the Tuning of PID Controller Parameters

Michał Laskawski, Mirosław Weislik

Abstract—The paper deals with an analysis of automatic control system with continuous and discrete PID controllers. A method of tuning the parameters of the continuous controller is presented, which is optimal according to the ITAE criterion. The behavior of control systems with discrete controllers whose parameters were tuned using the mentioned method are described. The impact of changes in the sampling period of controlled signal on the control quality is shown. Changes of the values of optimal parameters of discrete PID controllers in relation to changes of the sampling rate of controlled signal are characterized.

Keywords—PID controllers, tuning, optimal control, sampling rates.

I. INTRODUCTION

THE general rules of the sampling period selection in control systems use the parameters of the identified controlled system model. The parameters are often: T_{max} - the dominant time constant, L - the transport delay time constant, T - inertia time constant [1], [2]. There are also known rules determining sampling period with respect to the control quality indicators such as: t_s - settling time and t_r - rise time, [2], [3]. These rules allow one to estimate the signal sampling period with respect to the identified controller parameters (T_i - integration time, T_d - differentiation time constant) and are presented in: [2], [4]. All of these rules do not specify precisely what value of sampling period Δt ought to be used. They allow one to only roughly estimate the acceptable value of interval Δt .

For modeling and analysis of discrete control system, it is assumed that the continuous control system is the reference system. It makes it easier to analyze the impact of sampling period of control signal on the control quality of the discrete system and the to choose of the optimal settings of discrete controllers. In the continuous system, the controller constantly monitors the controlled signal (process value) and the reference signal (setpoint value). On the basis of these signals it generates a control signal.

The settings of PI and PID controller are often selected using methods that are designed for continuous controllers [5], [6], [7]. Badly selected continuous controller parameters can cause poor quality of control. The quality of control can deteriorate even more if the selected settings are used with a controller which responds to the input signals periodically, just like discrete controller. To avoid this, the controller parameters are selected using an optimization method taking into account

the sampling period. Such a method was proposed in [8] and it is briefly described in the next section.

II. OPTIMAL SETTINGS OF CONTINUOUS PI AND PID CONTROLLERS

A closed-loop control system with continuous PID controller analyzed in [8] is shown in Fig. 1. It was assumed

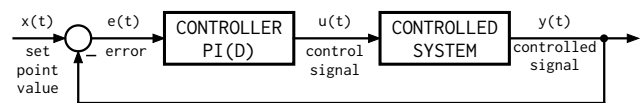

Fig. 1. The diagram of a basic control system with continuous PID controller.

that PID controller has the form:

$$G_{c(s)} = K_c \left[1 + \frac{1}{sT_i} + \frac{sT_d}{\frac{sT_d}{N} + 1} \right] \quad (1)$$

where: K_c - proportional gain, T_i - integral time, T_d - derivative time, N - dimensionless coefficient.

The value of the dimensionless coefficient N is determined by bibliography analysis. Usually the value of the coefficient is in the range of 2 to 30 [9]. It was assumed that $N = 20$ [8].

The dynamics of the controlled system is approximated by a first-order inertial model with transport delay.

$$G(s) = \frac{Ke^{-sL}}{1 + sT} \quad (2)$$

where: K - static gain, T - inertia time constant, L - transport delay time constant.

The model description can map the dynamics of a wide range of industrial processes with satisfactory accuracy. It also makes it possible to model the steady state. The presence of a transport delay allows an approximation of potentially unstable processes.

The ITAE (integral of time-weighted absolute error) was selected as an optimality criterion [10]:

$$ITAE = \int_0^t t |e(t)| dt \quad (3)$$

A. The Tuning Procedure

The procedure for the selection of the optimal settings of PI and PID controllers consists of a few steps.

- First, the proportional and derivative parts of the PID controller are disconnected. For the PI controller, only the proportional part is disconnected.

Leaving the integral part of the controller at this stage of the procedure is a distinctive feature of the method.

It approximates the current system characteristic to the target systems characteristics with PI or PID controllers and facilitates the selection of the optimal controller parameters.

According to the assumption that controlled system can be approximated by model (2) the transfer function of the open-loop control system which consists of connected in series integral controller and model (2) is described by the equation:

$$G_O(s_o) = \frac{TKK_i e^{-s_o\theta}}{s_o(1+s_o)} \quad (4)$$

where: $s_o = sT$, $\theta = \frac{L}{T}$

The module of the spectral transfer function is as follows:

$$|G_O\omega_o| = \frac{KK_iT}{\omega_o\sqrt{1+\omega_o^2}} \quad (5)$$

where: $\omega_o = \omega T$.

- At the next stage of the procedure, the gain of the integral part of the controller is increased to get the closed loop system to border stability. At this stage, the controller ultimate gain K_i and the sustained oscillation angular frequency ω_{osc} of the controlled variable y are assessed.
- On the basis of these parameters and taking into account that $|G_O\omega_{osc}| = 1$ and (5) the time constant T of an approximating model is identified.

$$T = \frac{\sqrt{(KK_i)^2 - \omega_{osc}^2}}{\omega_{osc}} \quad (6)$$

- The coefficient θ is calculated from the equation describing an argument of (5) at the stability border:

$$-\pi = \frac{-\pi}{2} - \arctan(\omega_o\omega_{osc}) - \omega_o\omega_{osc}\theta \quad (7)$$

Taking into account that $\omega_o\omega_{osc} = \omega_{osc}T$ the θ coefficient is described by the equation:

$$\theta = \frac{\frac{\pi}{2} - \arctan(\omega_{osc}T)}{\omega_{osc}T} \quad (8)$$

- The set of equations (9) describe the optimal settings of the PI controller [8].

$$K_c = \frac{10^{\frac{0.49}{\sqrt{\theta}} - 0.67}}{K} \quad (9)$$

$$T_i = (0.0058\theta^2 + 0.31\theta + 0.91)T$$

The optimal settings of the PID controller are described by set of equations 10 [8].

$$K_c = \frac{10^{\frac{0.81}{\sqrt[3]{\theta}} - 0.79}}{K} \quad (10)$$

$$T_i = (0.4\theta + 0.97)T$$

$$T_d = (0.48\sqrt{\theta} - 0.16)T$$

The equations (9) and (10) were obtained using the approximation of the set of PI and PID optimal settings. The least squares method was used in this purpose. The obtained formulas provide acceptable accuracy for $\theta = [0.2, 2]$.

B. The Impact of the Proposed Settings on Control Quality

Examples of step responses of the continuous systems with PID controllers were shown in Fig. 2. The controllers parameters were selected using the Ziegler-Nichols method [5] and the proposed method [8]. The controlled system has a transfer function described by (2) with $\theta = \frac{L}{T} = 0.2$.

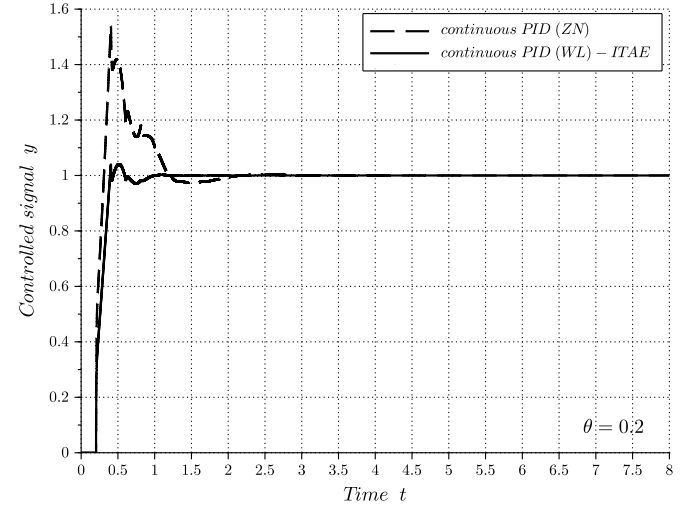

Fig. 2. The transients of the continuous control system with the PID controller.

The use of the proposed method causes a slight increase of the rise time as well as a decrease of the settling time and the overshoot value. The control quality is significantly better than for the Ziegler-Nichols method.

The transients for the proposed method in Fig. 2 have some pulse disturbances. They arise from an interaction between the derivative part of the PID controller and the transport delay of the controlled system.

III. OPTIMAL SETTINGS OF DISCRETE TIME PI AND PID CONTROLLERS

The block diagram of an automatic control system with discretized control signal with sampling period Δt is shown in Fig. 3.

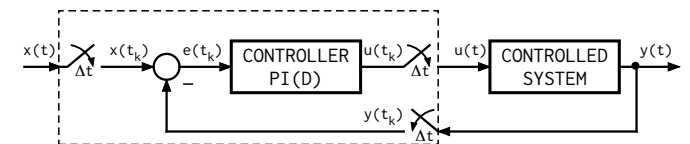

Fig. 3. Discretized automatic control system.

Simulation of the system presented in Fig. 3 requires the separation of the elements that are solved with different periods. The summation node as well as the controller are solved with period Δt . For the continuous part of the system, the model of the controlled system is solved with the step δt . The step δt may be either fixed or variable. It depends on the chosen method of solving differential equations describing the controlled system.

A. An Implementation of the Discrete-time Controller

In SIMULINK environment, the above discrete control system requires two ZOH (zero-order hold) extrapolators, which must be placed before and after the continuous model of the controller (Fig. 4).

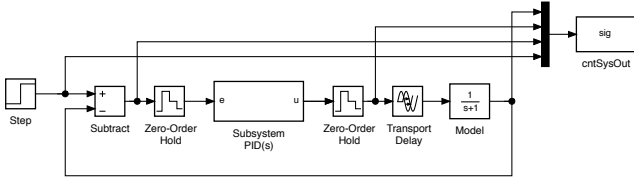

Fig. 4. Diagram of the discrete control system in SIMULINK.

Simulation results show that the insertion of the ZOH extrapolators into the continuous system (Fig. 4) causes system instability, even if the original continuous system was stable and the transient of the controlled signal was optimal.

For the coefficient $N = 20$ the instability occurs even for small values of the period Δt . Optimal settings of the controller (1) which are used with the system of Fig. 4 have to be selected taking into account the sampling period Δt . The problem may be avoided by using the discrete form of the PID controller.

The discrete controller form discussed above was used in control system shown in Fig. 5.

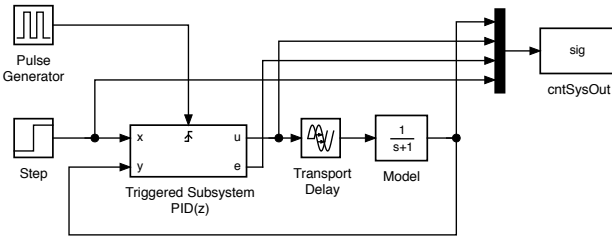

Fig. 5. Diagram of control system with a discrete controller in SIMULINK.

In block diagram in Fig. 5 the controller equations were obtained using the Euler-Forward method [11], which gives the PID controller equation applied to (1). It makes the system in Fig. 5 correspond to the system in Fig. 4. That form of equation of the PID controller is often implemented in control devices [13]:

$$u_k = K_c \left[e_k + \frac{\Delta t S_k}{T_i} + \frac{T_d (e_k - e_{k-1})}{\Delta t} \right] \quad (11)$$

where: $S_k = S_{k-1} + e_k$.

Equation (11) is called the position algorithm. Its SIMULINK diagram is shown in Fig. 6. The block diagram from the Fig. 6 is placed within the Triggred Subsystem PID(z) block in diagram in Fig. 5.

B. Simulation Results

The transients of the output (controlled) signal for the control systems with the continuous (1) controller and with

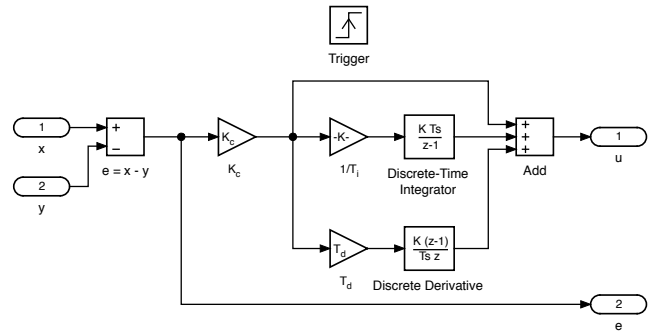

Fig. 6. Position PID algorithm diagram in SIMULINK.

the discrete (11) controller are shown in Fig. 7 for the signal sampling period: $\Delta t = 0.001$. According to the time scaling of the control system, the sampling period Δt is related to the inertia time constant T .

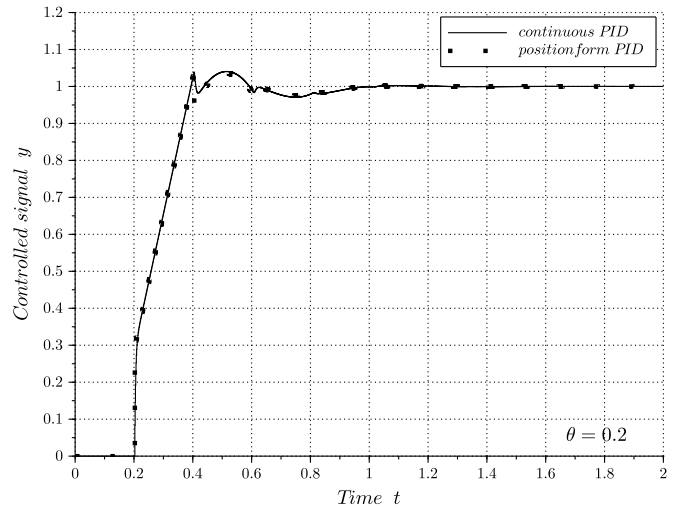

Fig. 7. Transients of the continuous and discrete control system.

Settings for both controllers were calculated from equations (10). The controlled system was defined by the formula (2) with coefficient $\theta = L/T = 0.2$. Transients of the controlled signal obtained from discrete and continuous control systems are very close (Fig. 7). The similar behavior of the continuous (1) and the discrete (11) controllers is observed for a relatively high value of the coefficient N . As was previously mentioned, the value of N is equal to 20. This value of the coefficient N lowers the filtering influence in the derivative component of the continuous controller (1).

The step responses of the control systems with the PI and the PID controllers are shown in Figs. 8 and 9. Simulations were made for various values of Δt . In each simulation the controller parameters were set up to the optimal values calculated for the continuous controller (1). It can be seen that despite the selecting optimal parameters, the increase of the Δt causes loss of the control quality for both types of controllers. The PID controller is more sensitive to the change of Δt (Fig. 9).

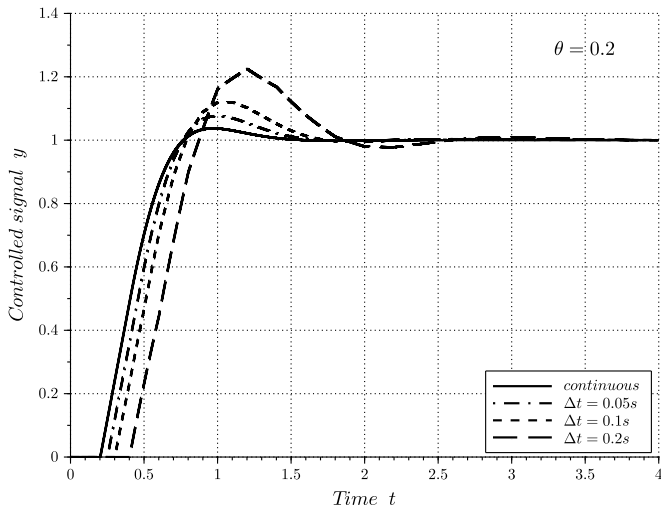

Fig. 8. Transients of the controlled variable in the control system with PI controller for different sampling periods.

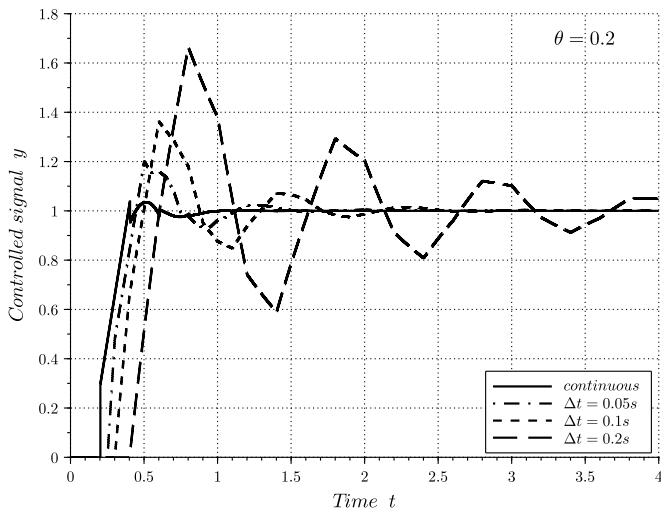

Fig. 9. Transients of the controlled variable in the control system with PID controller for different sampling periods.

C. Influence of the Sampling Rate on the Discrete-time PI Controller Parameters

The Nelder-Mead method was used to find optimal (3) settings of PI controller [12]. Optimal parameters of the PI controller are shown in Fig. 10. The results show the influence of the sampling period of the control signal on the control quality and optimal parameters of the controller. It can be seen that the increase of the sampling period Δt causes the decrease of the optimal value of the proportional gain K_c . Simultaneously, the optimal value of the integral time T_i increases. The system behaves this way for small values of θ . Along with the increase of the coefficient θ , the optimal values of K_c decrease and are almost independent of the sampling period. The optimal values of T_i are more sensitive to the sampling period. It means that for systems with small θ the use of the optimal settings of the continuous controller for the discrete controller requires one to change both of its

parameters: K_c and T_i . For the systems with larger θ only the T_i value ought to be changed.

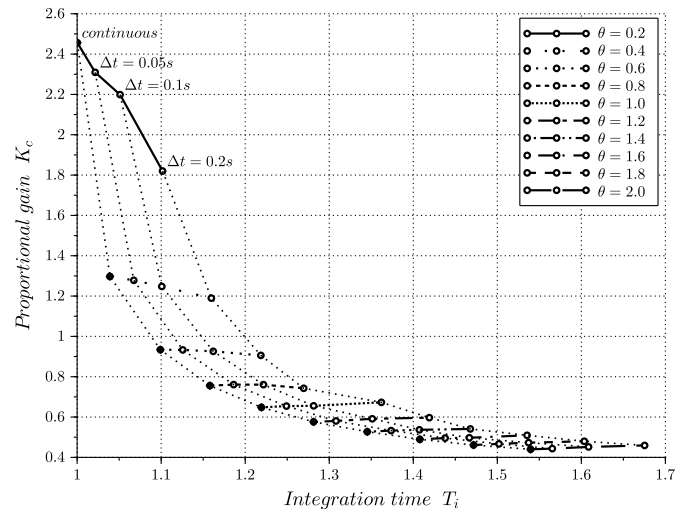

Fig. 10. Optimal parameters of the PI controllers for different values of: the θ coefficient and the sampling period Δt .

The ITAE index optimal values as a function of the sampling period Δt of control signal are shown in Fig. 11. These values correspond to the settings shown in Fig. 10.

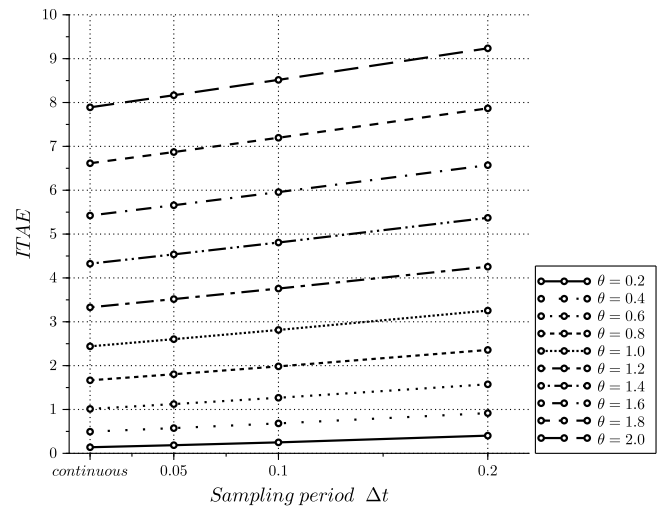

Fig. 11. ITAE optimal values as a function of Δt , for a system with PI controller.

Continuous control systems are characterized by the lowest values of the ITAE index (Fig. 11). The phenomenon occurs for all values of θ . It means that the continuous system gives the best control quality. The use of a discrete controller only degrades the quality of control. The controller responds to the system signals in a periodic manner with the period Δt , therefore a part of information about the control system state between samples is lost. The discrete controller generates the control signal based on the deficient data. It has to lead to a loss of control quality.

The step responses of the system with PI controller are shown in Fig. 12. The controller settings were chosen according to Fig. 10. The controlled system has $\theta = 0.2$.

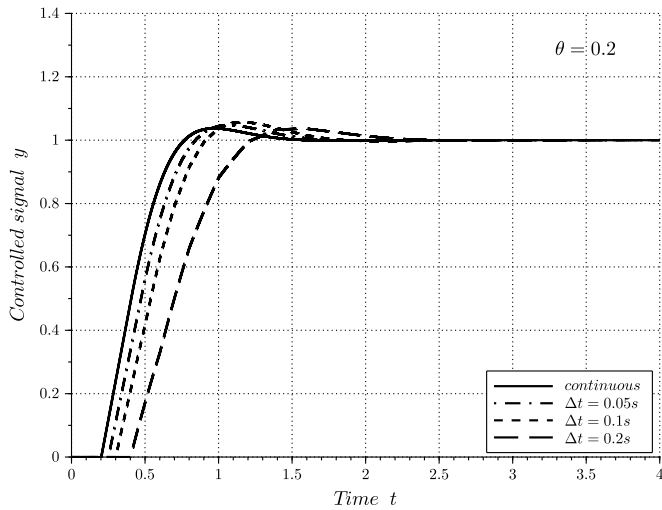

Fig. 12. Transients of the controlled signals of control system with PI controller for optimal settings related to the period Δt .

Plots in Figs. 8 and 12 show that the overshoot was reduced, especially for the system with a large value of sampling period Δt . The rise time was elongated. It causes the slowing down of the transient of the controlled variable. However, the settling time has been improved.

D. Influence of the sampling rate on the discrete-time PID controller parameters

Optimal PID controller settings were identified with use of the Nelder-Mead method. These settings as a function of θ and Δt coefficients are shown in Figs. 13, 14 and 15.

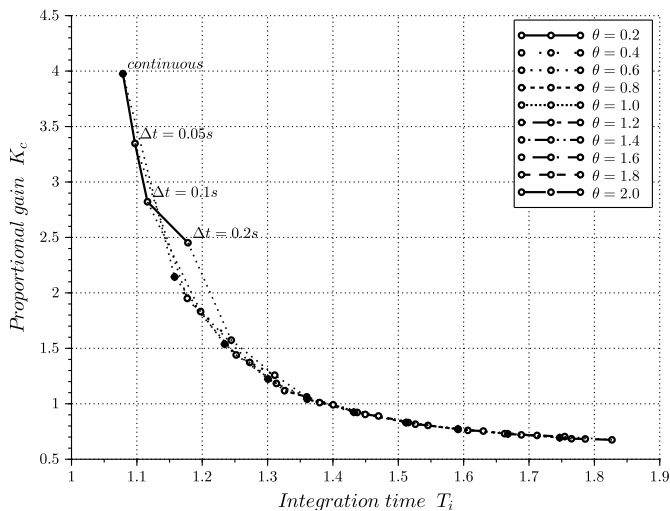

Fig. 13. Optimal values: K_c, T_i of the PID controllers for different values of: the θ coefficient and the sampling period Δt .

As it is shown in Fig. 13 for the small value of θ the optimal value of the proportional gain K_c decreases with the increase of Δt . Simultaneously, the optimal value of integral time T_i increases. The optimal value of derivative time T_d decreases along with an increase in Δt - Fig. 14. It should be noted that for small values of θ the change of T_d is relatively small

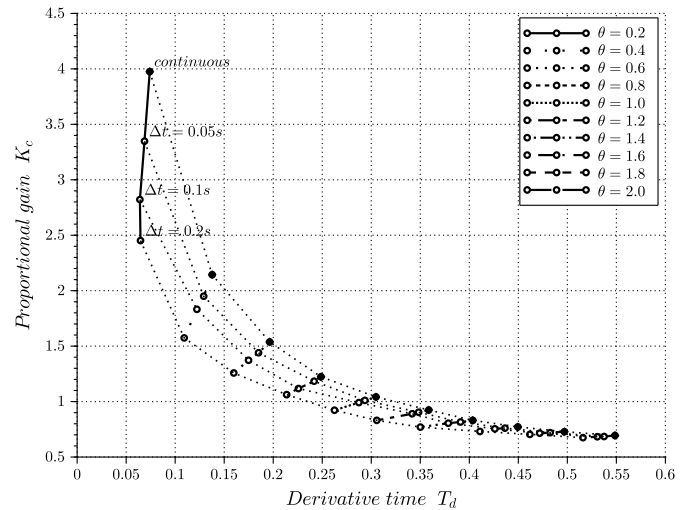

Fig. 14. Optimal values: K_c, T_d of the PID controllers for different values of: the θ coefficient and sampling period Δt .

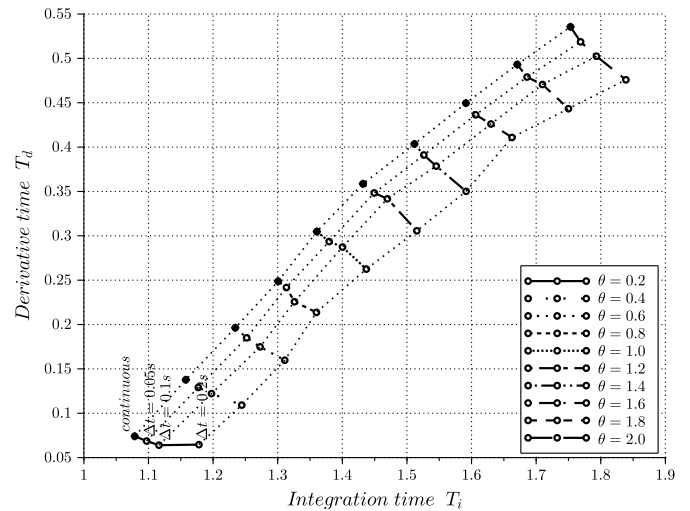

Fig. 15. Optimal values: T_d, T_i of the PID controllers for different values of: the θ coefficient and sampling period Δt .

(Figs. 14 and 15). Along with the increase of θ the range of optimal values of K_c decreases, while the ranges of changes of optimal values of T_i and T_d increase.

It means that for systems with small θ the use of the optimal settings of the continuous controller for the discrete controller requires a significant change of K_c , small changes of T_i and almost no change of T_d . For the systems with larger θ both: T_i and T_d must be changed, while K_c may remain almost unchanged. In relation to the PI controller the control system with use of PID controller is more sensitive to proportional gain K_c (Figs. 10 and 13).

The ITAE index optimal values as a function of the sampling period of the controlled signal for a system with PID controller are shown in Fig 16.

Just as for the system with PI controller the best control quality is observed for continuous control system with PID controller. The use of the discrete controller only degrades control quality. The use of the PID controller improves control

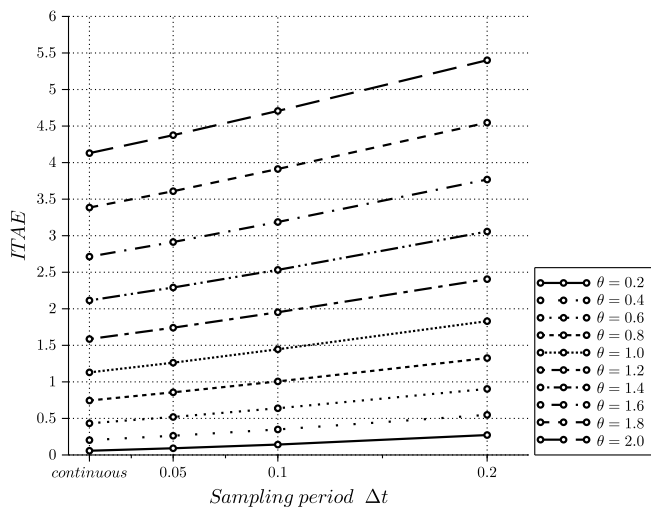

Fig. 16. ITAE optimal values as a function of Δt , for a system with PID controller.

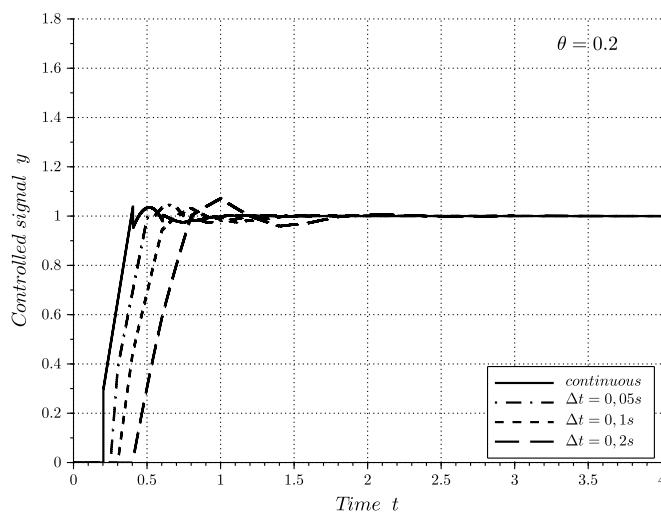

Fig. 17. Step responses of the control system with PID controller for optimal settings related to the period Δt .

quality, especially for the systems with large values of the θ (Figs. 11 and 16).

The optimal step responses of the system with PID controller are shown in Fig. 17. The controller settings corresponding to the values are shown in Figs. 13 and 14. Comparing the plots in Figs. 9 and 17 it can be seen that the control quality has been significantly improved especially

for the systems with large value of the sampling period. The overshoot has been reduced and the settling time became shorter.

IV. CONCLUSION

The settings of the PI and the PID controllers chosen using the authors method [8] allows one to achieve optimal (3) control quality of the controlled system. These settings used with discrete controllers do not provide optimal control quality. The control quality decreases with the increase of the sampling period Δt of the control signal. To maintain the required quality, value correction of the controller settings is needed.

Changes of control quality and the changes of controller settings they require depend on the chosen form of the discrete controller. It was noted that the discrete implementation of continuous controller whose equation was derived using the Euler-Forward method is very sensitive to changes of the control signal sampling rate, especially for the higher values of the N coefficient in (1). Even a small value of Δt may destabilize a system which is stable and optimally tuned with the continuous controller.

REFERENCES

- [1] R. E. Kalman, J. E. Bertram. General synthesis procedure for computer control of single-loop and multi-loop systems. *AIEE Trans*, 1958.
- [2] K. J. Åström, B. Wittenmark. *Computer controlled systems*. Prentice-Hall information and system sciences series. DA Information Services, 1, 1984.
- [3] R. Isermann. *Digital control systems*. Springer-Verlag, 1981.
- [4] H. A. Fertik. *Tuning controllers for noisy processes*. ISA-Trans, 1975.
- [5] J. G. Ziegler, N. B. Nichols. Optimum setting for automatic controllers. *Rochester, N.Y.*, 1942.
- [6] K. J. Åström, T. Häggglund. Automatic tuning of simple regulators with specifications on phase and amplitude margins. *Automatica*, 20(5):645–651, 1984.
- [7] K. J. Åström, T. Häggglund. *PID controllers theory design and tuning*. ISA: The Instrumentation, Systems, and Automation Society, 2, 1995.
- [8] M. Wcislik, M. Laskawski. Nowa metoda doboru nastaw regulatorow PI oraz PID dla modelu Kupfmullera. *Postepy automatyki i robotyki*, 2011.
- [9] A. O'Dwyer. *Handbook of PI and PID Controller Tuning Rules*. Imperial College Press, 2006.
- [10] D. Graham, R. C. Lathrop. The synthesis of optimum response: Criteria and standard forms. *Transactions of the AIEE*, 72(II):273–288, 1953.
- [11] S. Buso, P. Mattavelli. *Digital control in power electronics*. Morgan and Claypool Publishers, 1, 2006.
- [12] R. Matousek, P. Minar, S. Lang, P. Pivonka. Hc12: Efficient method in optimal pid tuning. *Proceedings of the World Congress on Engineering and Computer Science*, 2011.
- [13] B. G. Liptak. *Process Control and optimization*, vol 2 series *Instrument engineers' handbook*. CRC Press – Taylor and Francis Group, 4, 2006.