

B. PŁONKA\*, P. KORCZAK\*, K. REMSAK\*, M. LECH-GREGA\*

## COMPARISON OF STRUCTURE, MECHANICAL AND ELECTRICAL PROPERTIES OF Al ALLOY DIE FORGED PARTS MADE WITH USE OF DIFFERENT STOCK MATERIAL

### PORÓWNANIE STRUKTURY ORAZ WŁAŚCIWOŚCI MECHANICZNYCH I ELEKTRYCZNYCH ELEMENTÓW ZE STOPU Al KUTYCH MATRYCOWO PRZY ZASTOSOWANIU ZRÓŻNICOWANEGO MATERIAŁU WSADOWEGO

The paper presents the results of the die forging tests of a modified EN AW-6101 alloy with the addition of Zr, using two types of the feedstock materials. The first feedstock materials were ingots cast in a vertical semi-continuous process, the second feedstock materials were extruded rods. The die forging process was carried with parameters enabling "on line" heat treatment (T5 temper). For comparison, forgings were also heat treated to the T6 temper and to thermo-mechanical treated to the T8 and T9 temper. Then forgings made from both feedstock materials were characterised in terms of structure, mechanical properties and electrical conductivity.

*Keywords:* Al alloys, electrical conductivity, heat treatment, die forging

W artykule zamieszczono wyniki badań kucia matrycowego, zmodyfikowanego stopu EN AW-6101 z dodatkiem Zr, przy zastosowaniu dwóch rodzajów materiałów wyjściowych. Pierwszym materiałem były wlewki odlewane w technologii półciągłej pionowej a drugim pręty wyciskane. Proces kucia matrycowego realizowano przy parametrach umożliwiających przesycanie wyrobów z temperatury przeróbki plastycznej (stan T5) oraz dla porównania obrabiano cieplnie odkuwki do stanu T6 i cieplno-mechanicznie do stanów T8 i T9. Następnie odkuwki wykonane z obu materiałów wsadowych zostały scharakteryzowane pod kątem struktury, właściwości mechanicznych oraz przewodności elektrycznej.

## 1. Introduction

The growing demand for electricity, and a steady increase of its cost are forcing the search for ever more efficient technologies for power transmission lines. Particular interest are conducting the solutions, which enable increasing the current-carrying capacity and mechanical properties of overhead lines, such as high-temperature conductors, known as high temperature low sag (HTLS) conductors [1,2,3]. But in spite of access to high technologies, still very popular (due to low prices and favourable properties) are wires made of alloys from the 6000 series (mainly 6101 and 6201) [4]. The design of power lines is always a compromise between the cost of the project, the current carrying capacity and the size of transmission losses, and therefore it is so important to keep low resistivity (high electrical conductivity) of the wires (about 31 MS/m for wires made from the 6000 series alloys). At this point it seems pertinent to look more closely at the materials from which the connectors and fittings for power lines are produced. The best solution in this case would be a material of the same electrical conductivity as the wires it connects. Unfortunately it is difficult to combine this feature with another very important feature it should possess and which are the adequate mechanical properties. The consequence of the

above mentioned difficulties is great popularity of alloys such as 6060, 2017 (A) and 6082 used as a material for the manufacture of electrical equipment, while wires are made from alloys in grade 6101 and 6201. The use for power connectors of materials so obviously different as regards their composition must result in problems related with corrosion and decrease of conductivity.

## 2. Test material

Studies were carried out on die forgings made from the EN AW-6101 alloy after modification. The feedstock material consisted of billets casted in a vertical semi-continuous system and of extruded rods [5,6]. The choice of the feedstock for forging was dictated by economic considerations of the technology of making forged components for overhead power lines, since forging directly from cast materials enables elimination of extrusion from the technological process. Forgings made from cast feedstock are less anisotropic than their counterparts forged from extruded rods [7,8]. Moreover, mechanical properties of forgings made from the cast feedstock are comparable with the mechanical properties of forgings made from the feedstock composed of extruded rods, and having more favourable structure can in many cases even exceed these

\* INSTITUTE OF NON-FERROUS METALS, LIGHT METALS DIVISION, 19 PIŁSUDSKIEGO STR., 32-050 SKAWINA, POLAND

properties. The aim of this study was to compare the structure, mechanical properties and conductivity of forgings made of various starting materials mainly in two conditions of the heat treatment, i.e. T5 and T6, and examine the possibility of the use of thermo-mechanical processing to the condition T8 and T9 [9].

Tests were conducted on billets casted at IMN OML Skawina [3] from the EN AW – 6101 alloy of the composition as stated in Table 1. From these billets, two variants of the feedstock for further die forging tests were obtained, i.e. the feedstock extruded and the feedstock cast, all in accordance with the conditions set out in Table 2.

TABLE 1  
Chemical composition of tested materials

Alloy	Fe	Si	Cu	Zn	Ti	Mn	Mg	Cr	Zr
EN AW-6101	0,15	0,71	0,01	0,020	0,015	0,004	0,61	0,001	0,12

TABLE 2  
Casting and extrusion process parameters

Feedstock	Parameters	
Casted	Temperature of liquid metal:	675°C
	Casting mold:	HOT-TOP Ø100mm
	Casting speed:	200 mm/min
Extruded	Temperature of material:	530°C
	Temperature of container:	480°C
	Extrusion ratio ( $\lambda$ ):	22
	Die diameter:	35 mm
	Ram speed:	1,5 mm/s
	Solutioning on the press run out (on-line)	without – option "A" with – option „B"

Figure 1 shows an example of macro-and microstructure of the cast billet and extruded rod with information on the average starting grain size obtained in these materials before die forging. The microstructures in Figure 1 show that the cast ingot has finer grains than the extruded rod. The grain refining effect resulting from the addition of Zr becomes evident only after the plastic working and heat treatment [2,3].

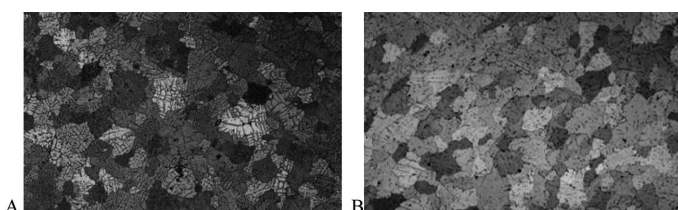

Fig. 1. Macro and microstructure of the cast billet – A (average grain size  $d = 177\mu\text{m}$ ) and extruded rod – B (average grain size  $d = 160\mu\text{m}$ )

### 3. Die forging tests

The feedstock for the forging process in the form of Ø35 mm rod was extruded on a 5MN horizontal press at IMN OML Skawina [10]. Extrusion process was conducted with “on line” solution heat treating – (option “B”), and without it (option “A”). The process parameters are shown in Table 2. The resulting feedstock was forged on a vertical 2,5MN hydraulic press available at IMN OML Skawina [11]. The process parameters are given in Table 3 [4].

TABLE 3  
Billets extrusion process parameters used for forging tests

CASTED FEEDSTOCK (Ø 35x125mm bars machined from Ø 100 vertical casted billets)	
T5 Temper	forging 530°C → solutioning „on line” → aging 180°C/10h
T6 Temper	forging 530°C → solutioning 540°C/2h → aging 180°C/10h
T8 Temper	solutioning „on line” → cold forging → aging 140°C/7h
T9 Temper	solutioning „on line” → aging 180°C/10h → cold forging
EXTRUDED FEEDSTOCK (extruded Ø 35x125mm bars)	
T5 Temper	forging 530°C → solutioning „on line” → aging 180°C/10h
T6 Temper	forging 530°C → solutioning 540°C/2h → aging 180°C/10h
T8 Temper	solutioning 530°C/3h → cold forging → aging 140°C/7h
T9 Temper	solutioning 530°C/3h → aging 180°C/10h → cold forging

To investigate more thoroughly the metal flow behaviour before the forging test, forgings of special shape and different cross-sections were designed (Figures 2 and 3). Photos on Figures 4-5 shows the press with instrumentation during conducting of the tests.

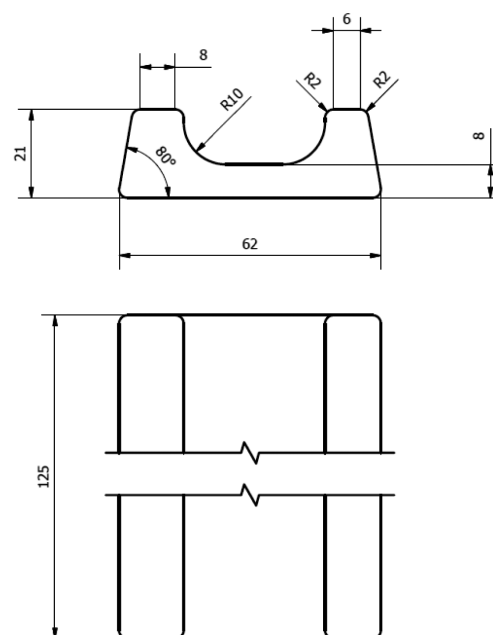

Fig. 2. Test-forging projected in OML Skawina

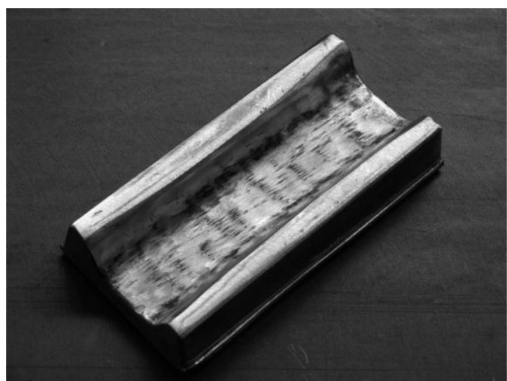

Fig. 3. Forging preformed on OML Skawina hydraulic 250T Press



Fig. 4. Forging set with die forging tools mounted



Fig. 5. Hydraulic press, max force 250T

For the extruded material, the whole research programme was successfully implemented, which means that, for all the heat treatment conditions (T5, T6, T8 and T9) correct forging were obtained, i.e. free from the defects and cracks, and with complete filling of the die impression. On the other hand, from the cast feedstock, correct forgings were obtained only for the T5 and T6 tempers. Trials of cold forging for the condition T8 and T9 ended in failure – the material cracked and did not fill the die impression. The cast material without previous

toughening has proved to be unsuitable for so intensive cold deformation.

#### 4. Results of research

The ready forgings were subjected to structure examinations, revealing the grains by Barker's method. Mechanical properties were determined in static tensile test, followed by electrical conductivity measurements. The resulting microstructures are shown on Figures 6-15.

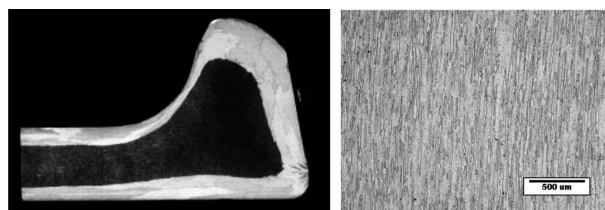

Fig. 6. Macro and microstructures of forgings made from extruded feedstock – T5 temper option „A”

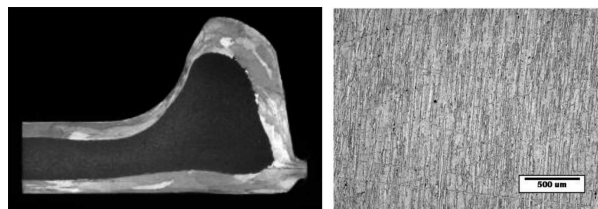

Fig. 7. Macro and microstructures of forgings made from extruded feedstock – T5 temper option „B”

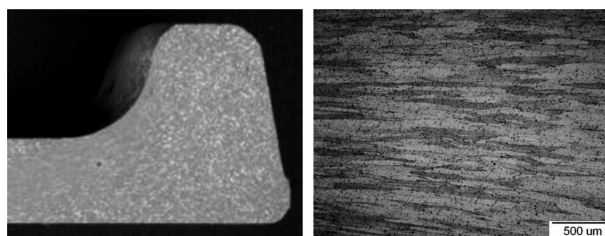

Fig. 8. Macro and microstructures of forgings made from casted feedstock – T5 temper

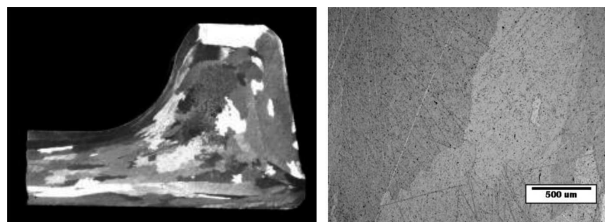

Fig. 9. Macro and microstructures of forgings made from extruded feedstock – T6 temper option „A”

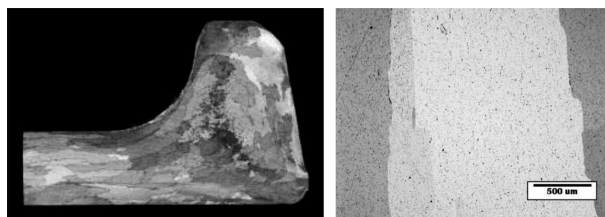

Fig. 10. Macro and microstructures of forgings made from extruded feedstock – T6 temper option „B”

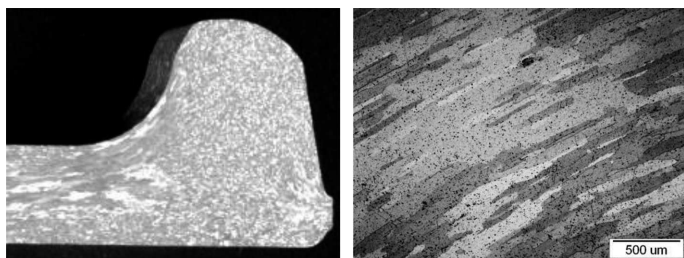

Fig. 11. Macro and microstructures of forgings made from casted feedstock – T5 temper

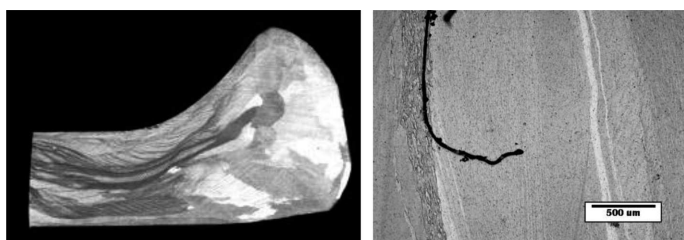

Fig. 12. Macro and microstructures of forgings made from extruded feedstock – T8 temper option „A”

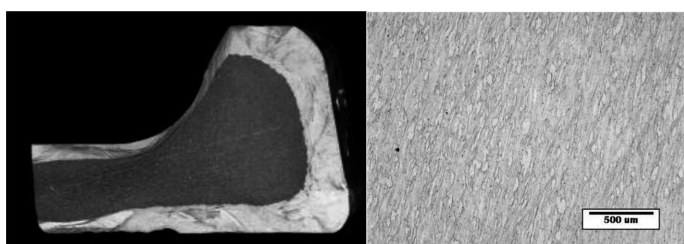

Fig. 13. Macro and microstructures of forgings made from extruded feedstock – T8 temper option „B”

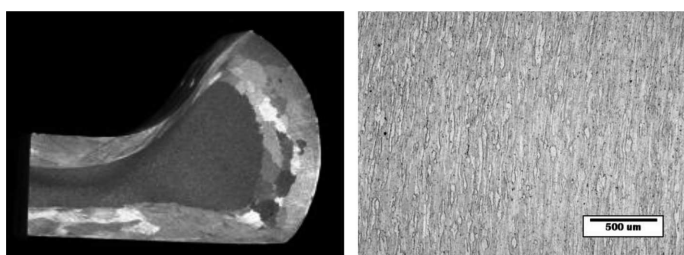

Fig. 14. Macro and microstructures of forgings made from extruded feedstock – T9 temper option „A”

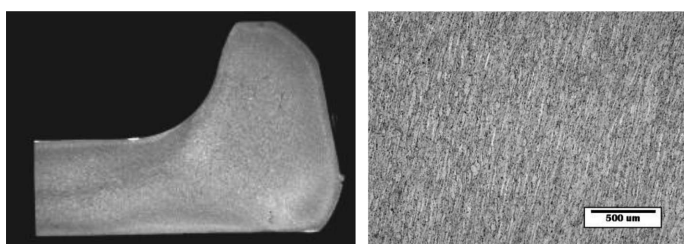

Fig. 15. Macro and microstructures of forgings made from extruded feedstock – T9 temper option „B”

Analysing the images of the obtained structures, it is interesting to note, that the grains show a considerable degree

of growth and there is coarse-crystalline envelope formed on the material extruded and re-heated before forging or solution heat treatment carried out in furnace. A clear coarse crystalline envelope appears in nearly all variants of the extruded rods, even in those that were cooled after the extrusion process on the press run out in a “water wave” (variant “B”) and then re-heated for forging or solution heat treatment. Only in rods extruded, “on-line” solution heat treated on the press run out table (variant “B”), aged artificially and then cold forged (T9 temper), the structure was very fine, homogeneous and without the coarse crystalline envelope. In forgings made from the extruded rods, re-heated after forging for the heat treatment (T6 temper, variants “A” and “B”), the structure recrystallised within its entire volume, and coarse, largely differentiated grains appeared. Similar situation occurred for the T8 temper in variant “A”. The heat treatment conditions involving forging of the material after solution heat treatment (T8 temper) and solution heat treatment carried out from the forging process temperature (T5 temper) with subsequent artificial aging resulted in the structure with high degree of refinement and homogeneity of grains inside forgings, especially when using feedstock that was solution heat treated on the press run out table during the extrusion process –variant “B”.

Forgings made of cast feedstock were characterised by a homogeneous structure without the coarse crystalline envelope typical for extruded rods. Forgings in the T5 temper had finer grains than in the T6 temper which is associated with partial recrystallisation of the material. Generally speaking, disregarding issues related with the presence of the coarse crystalline envelope and comparing only the internal structure, it can be seen that forgings made from cast ingots have the grain size comparable to forgings made from extruded rods heat treated to the T5 temper, while grains are definitely more refined and homogeneous in the T6 temper. In terms of the structure, the best compromise gives the thermo-mechanical processing to the T5 temper using feedstock both cast and extruded.

TABLE 4

Mechanical parameters of forgings

Designation/ option	Extruded feedstock			Casted feedstock		
	R <sub>0,2</sub> [MPa]	R <sub>m</sub> [MPa]	A[%]	R <sub>0,2</sub> [MPa]	R <sub>m</sub> [MPa]	A[%]
T5 / “A”	272	300	16,4	285	305	16,3
T5 / “B”	223	262	15,2	-	-	-
T6/ “A”	266	266	10,9	290	302	9,3
T6 / “B”	270	271	9,9	-	-	-
T8/ “A”	259	363	12,1	-	-	-
T8 / “B”	378	383	14,3	-	-	-
T9/ “A”	415	421	10,3	-	-	-
T9 / “B”	311	318	10,1	-	-	-

Studies of the mechanical and electrical properties clearly demonstrated that the best mechanical parameters were ensured by heat treatment to the condition T8 and T9, while the highest electrical conductivity showed forgings in the T5 temper. Lower conductivity values obtained for cold-forged

parts can be explained by the presence of crystallographic structure defects such as dislocations, vacancies, etc., formed during the forging process and hindering the flow of electrical current. On the other hand, these structural factors are highly desirable when the material hardening effect is required. For similar reasons, in the T5 temper, the conductivity is higher at the expense of lower mechanical properties – here the strain hardening is eliminated as a result of the recovery and dynamic recrystallisation at high temperature, while mechanical properties are shaped by the process of precipitation hardening.

4. Forgings for which the feedstock was cast material after heat treatment were generally characterised by lower elongation and electrical conductivity as compared to forgings made from the extruded rods with similar or even higher mechanical properties.
5. Practically all the applied variants of the thermo-mechanical processing (forging of extruded rods) provided high electrical conductivity (29-31 MS/m).

#### Acknowledgements

The research was carried out under Project No. POIG.01.03.01-00-086/09-01 entitled: "Advanced manufacturing technologies to make functional materials for energy transmission, processing, and storage" co-financed from the structural fund; the project implementation period is 2009-2014.



#### REFERENCES

- [1] T. Knych, M. Piwowarska, P. Uliasz, Arch Metall Mater **56**, 685-692 (2011).
- [2] T. Knych, M. Piwowarska, P. Uliasz, Arch Metall Mater **58**, 145-150 (2013).
- [3] T. Knych, A. M am a l a, P. Uliasz, Hutnik, Wiadomości Hutnicze **70**, 1-2, 46-48 (2003).
- [4] M.H. Mulazimoglu, A. Zaluska, J.E. Gruzleski, F. Paray, Metall Mater Trans A **27A**, 929-936 (1996).
- [5] Z. Zamkotowicz, J. Żelechowski, M. Lech-Grega, J. Senderski, B. Płonka, Polska Metalurgia w latach 2006-2010, Komitet Metalurgii Polskiej Akademii Nauk, p.753-759 (2010).
- [6] J. Senderski, T. Stuczyński, J. Żelechowski, B. Płonka, Z. Zamkotowicz, P. Korczak, Hutnik, Wiadomości Hutnicze **78**, 1, 115-118 (2011).
- [7] S.N. Samaras, G.N. Haidemenopoulos, J Mater Process Tech **194**, 63-73 (2007).
- [8] B. Płonka, A. Kłyszewski, J. Senderski, M. Lech-Grega, Arch Civ Mech Eng **8**, 2, 149-156 (2008).
- [9] J. Senderski, B. Płonka, P. Korczak, J. Kut, K. Remsak, Hutnik, Wiadomości Hutnicze **78**, 1, 113-115 (2011).
- [10] J. Senderski, M. Lech-Grega, B. Płonka, Arch Metall Mater **56**, 475-486 (2011).
- [11] B. Płonka, M. Lech-Grega, K. Remsak, P. Korczak, A. Kłyszewski, Arch Metall Mater **58**, 127-132 (2013).

TABLE 5

Electrical conductivity of forgings

Designation / option	Extruded feedstock	Casted feedstock
	$\sigma$ [MS/m]	$\sigma$ [MS/m]
T5 / "A"	31,0	28,6
T5 / "B"	31,1	-
T6/ "A"	29,0	29,5
T6 / "B"	28,8	-
T8/ "A"	28,8	-
T8 / "B"	29,2	-
T9/ "A"	29,0	-
T9 / "B"	30,1	-

Considering the required mechanical and electrical properties, one has to choose between the high mechanical properties in the T8 and T9 temper and good conductivity in the T5 temper. In terms of the applications in power industry, the best option seems to be the T5 condition ensuring good conductivity combined with satisfactory mechanical properties.

#### 5. Conclusions

1. Studies proved the possibility of using cast feedstock as an alternative to extruded feedstock when making die forged parts of power connectors.
2. The use of extruded alloys resulted in a tendency to the formation of coarse crystalline envelope, which was not present in forgings made from the cast material.
3. Using extruded and heat treated feedstock, (with additional heating in furnace for T6 condition), an intensive grain growth was observed in forgings, which is a highly undesirable phenomenon.