

R. BURDZIK*, T. WĘGRZYN*, Ł. KONIECZNY*, A. LISIECKI**

RESEARCH ON INFLUENCE OF FATIGUE METAL DAMAGE OF THE INNER RACE OF BEARING ON VIBRATION IN DIFFERENT FREQUENCIES

BADANIA WPŁYWU USZKODZEŃ NA SKUTEK ZMĘCZENIA MATERIAŁU BIEŻNI WEWNĘTRZNEJ ŁOŻYSKA NA DRGANIA W RÓŻNYCH CZĘSTOTLIWOŚCIACH

The paper presents results of research on influence of fatigue metal damage of the inner race of bearing on vibration in different frequencies. The active diagnostics experiments were conducted on application of vibroacoustics methods for technical condition monitoring. Provides an overview of materials and process analysis of rolling bearings wear. The bearing damage of the inner race have been simulating. The research was conducted on special research-educational test bench for vibration monitoring for rotaring machinery. For the identification of the symptoms of the defects in the vibration signal the analysis of time realization and frequency transformation of the vibration have been conducted. For the comparison of the vibration of good and damage bearings signals registered for different frequencies have been presented in form of spectrograms and RMS distributions.

Keywords: vibration propagation in materials, material properties, vibroacoustics, wear of ball bearing

W ramach artykułu przedstawiono wyniki badań wpływu uszkodzeń powstałych na skutek zmęczenia materiału bieżni wewnętrznej łożyska na drgania w różnych częstotliwościach. Przeprowadzono szereg czynnych eksperymentów z wykorzystaniem metod wibroakustycznych do monitorowania stanu technicznego maszyny. Przedstawiono przegląd materiałów oraz analizę procesów zużycia łożysk tocznych. Eksperyment przeprowadzono dla uszkodzenia bieżni wewnętrznej łożyska. Badania przeprowadzono na specjalnym stanowisku badawczo-edukacyjnym – maszyny wirującej z monitoringiem drgań. W celu identyfikacji objawów uszkodzeń, sygnały drganiowe poddano analizie w dziedzinie czasu oraz częstotliwości. W celu porównania drgań obudowy dobrego i uszkodzonego łożyska zarejestrowane sygnały dla kolejnych badanych częstotliwości przedstawiono w formie spektrogramów i rozkładów wartości RMS.

1. Introduction

Fatigue causes many kind of damages in technical systems, especially for rotaring machinery. Analysis of vibration related phenomena is a solution commonly applied in Structural Health Monitoring (SHM) systems. One may distinguish between two major approaches to detection and positioning of defects in SHM systems, i.e. global [1] and local [2] methods. Among the said methods, one may also speak of those based on elastic wave propagation. It makes it possible to analyse a broad band of ultrasonic frequencies, i.e. from 0.2 to 30 MHz and higher.

Vibroacoustic diagnostics, based on the analysis of vibration or acoustic signals perceived as residual processes of non-invasive nature, is becoming more and more important in this respect. The scope of its application as well as the applicability of methods in numerous diagnostic systems also results from the capabilities of advanced methods of signal analysis and identification of numerous characteristics of technical condition [3-12].

The vibration phenomenas can be considered for different environment for the proper analysis of propagation and perception [13-18].

2. Research method

The research was conducted on special research-educational test bench for vibration monitoring for rotaring machinery – Vibstand (Fig. 1). The laboratory bench enables testing of application of vibroacoustics methods for applied structural health, usage and condition monitoring. It consists of the mechanical part and the vibration based condition monitoring and diagnostics system. The mechanical part, placed on a stiff support, includes three-phase asynchronous motor with frequency inverters, a gearbox, a shaft supported on two rolling element bearings. The shaft has got a disc with holes designed for imbalance simulation. The diagnostic part is comprised of a full featured condition monitoring system VIBex. The sensors can be mounted in one of the prepared holes or with a magnet,

* SILESIAAN UNIVERSITY OF TECHNOLOGY, FACULTY OF TRANSPORT, 8 KRASIŃSKIEGO STR., 40-019 KATOWICE, POLAND

** SILESIAAN UNIVERSITY OF TECHNOLOGY, FACULTY OF MECHANICAL ENGINEERING, 18A KONARSKIEGO STR., 40-100 GLIWICE, POLAND

in order to measure vibrations in a selected plane in selected construction nodes.

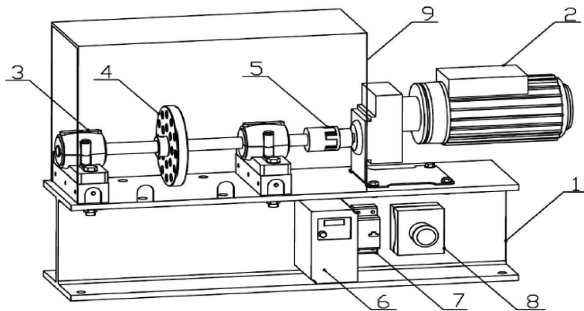

Fig. 1. Research test bench: 1 – support (steel frame), 2 – asynchronous motor, 3 – bearing with casing, 4 – disc with threaded holes, 5 – coupling, 6 – frequency inverter, 7 – electrical fuse, 8 – safety switch, 9 – housing made of organic glass

Measurement system (Figure 2) consisted of NI USB-9233 data acquisition device with signal conditioning and VIS-311 accelerometers. The main parameters of the elements has been presented in Table 1.

TABLE 1
Parametres of VIS-311 accelerometer and NI USB-9233 data acquisition device

VIS-311 accelerometer	
Sensitivity ($\pm 10\%$)	10.2 mV/(m/s ²)
Measurement Range	± 490 m/s ²
Frequency Range (± 3 dB)	0.5 to 10,000 Hz
Resonant Frequency	25 kHz
Broadband Resolution (1 to 10000 Hz)	3434 μ m/s ²
Non-Linearity	$\pm 1\%$
Transverse Sensitivity	$\leq 7\%$
NI USB-9233 data acquisition device with signal conditioning	
Number of channels	4
ADC resolution	24 bits
Type of ADC	Delta-sigma
Input delay (per channel)	25 kS/s
AC voltage full-scale range	± 5 V



Fig. 2. Elements of measurement system

During the research the acceleration of vibration were measurement on casing of bearing in two orthogonal axes. One along the shaft and the second vertical perpendicular. The location of sensors has been depicted in Fig. 3.

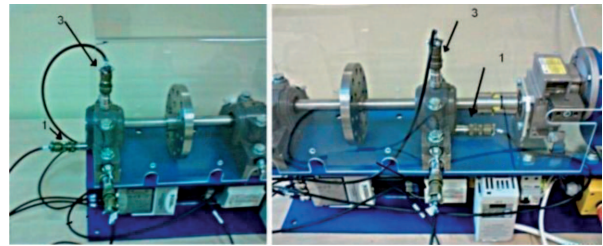

Fig. 3. Location of the sensors

For the purpose of analysis of possibilities of vibroacoustics methods research on influence of fatigue metal damage of the inner race of bearing on vibration the active diagnostic experiments were conducted for different frequencies.

3. Research object – ball bearing

Chosen defect of elements of the machine have been simulating. The defected element was the bearing. Construction of a typical roller bearing is shown in Fig. 4.

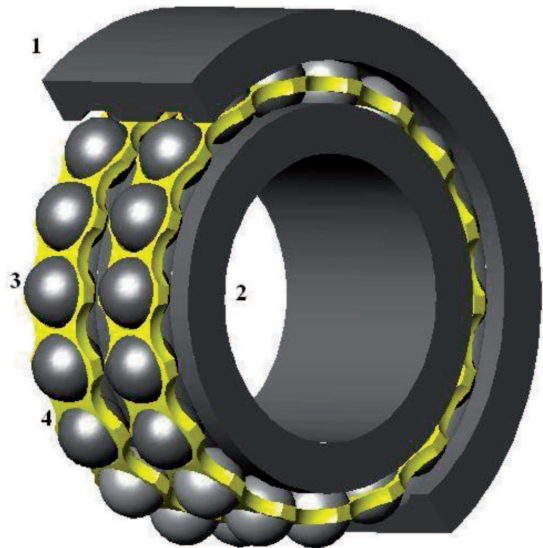

Fig. 4. Roller bearing 1 – outer ring, 2 – inside ring, 3 – rolling elements, 4 – separator

The performance and the possible use of roller bearings depend largely on the used materials in their manufacture. Rings and rolling element bearings are usually made of low-alloy chromium steel of high purity (100Cr6 – about 1% carbon and 1.5% chromium). This steel is normally given a martensitic or bainitic heat treatment during which it is hardened to the range 58-65 HRC. For bearings with larger dimensions used manganese steels (np.100CrMnSi6-4 better temper throughout). For heavily loaded bearings are used in low-alloy steels, nickel and chromium- manganese -chromium -hardened (hard surface abrasion on elastic core). When selecting the material must also take into account such factors as temperature dimensional stability, impact of corrosive media and low noise. In non-metallic materials used in the bearing may be mentioned ceramic materials – silicon nitride (lower weight, a lower coefficient of friction, very low coefficient of thermal expansion, corrosion resistance, paramagnetic properties, and insulating paraelectric).

Working bearing load causes repetitive cyclic pressure on the bearing elements (treadmills inner and outer rings and rolling elements). Fatigue metal surfaces contacting the raceways and rolling elements may lead to separation of the scaly particles of bearing material (so-called “peeling”). Rolling fatigue life determines the number of turns in time to the moment in which the bearing surface starts to peel (determined on the basis of statistical surveys).

The defected element was the bearing. In the one bearing damage of the inner race was done (Fig. 5).

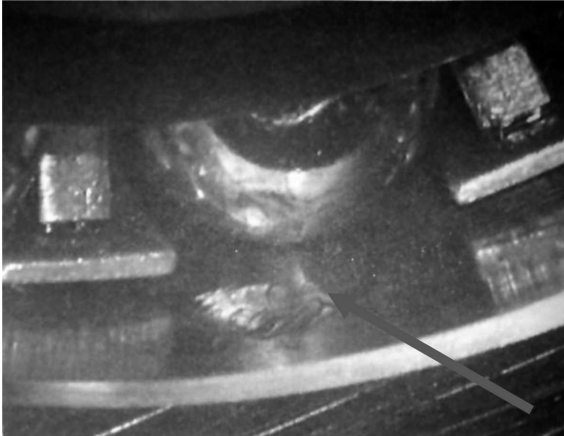

Fig. 5. Damage of the inner race of bearing

System of a rotating machine shaft – bearing – bearing housing – supporting structure is most responsible system reflects the dynamic state of the machine.

Faster bearing damage may be due to causes such as excessive load due to eg. the rotor unbalance or misalignment of shafts connected by couplings. Increased clearances and imbalance of the rotating components result in an increase of bearing vibration energy. As a result of this situation can be induced vibrations by resonance and much higher dynamic load bearing.

4. Ball bearings wear processes

Machines and other equipment in operating are subjected to many environmental factors. The impact of these factors causes changes in the functional characteristics of the equipment and machines. Especially harmful are irreversible processes that cause progressive deterioration of the operating characteristics and degradation of the system. The most important irreversible processes are: tribological wear of kinematic pairs, wear-called creep deformation of the material structure elements (under heavy load appears change of internal stress distribution as well as change in shape and dimensions) and fatigue wear (increase fatigue damage components subjected to dynamic loads) [28].

The wear of kinematic pairs can be characterized as the weight loss in the function of time (Fig. 6). There are three stages. The first stage (I), which occurs while starting the machine and is characterized by increased wear during the grind in of co-acting parts. In the second stage (II) the wear is gradually normalized. The third stage (III) is characterized

by a rapid increase of mass loss, which leads to failure of the element or the whole machine.

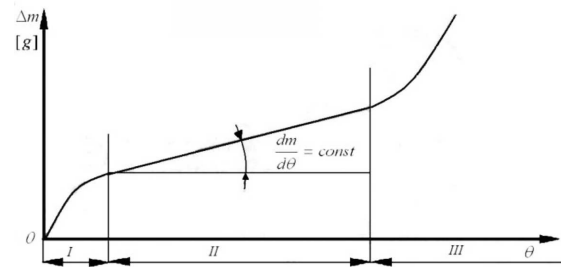

Fig. 6. The process of accumulation of mass losses in kinematic pairs as a function of time

A similar character has the process of changing the dimensions and shape of the creep-induced material (Fig. 7). Changes in this case depends mainly on the temperature and the size of stress. The first phase shows a decreasing relative velocity of plastic deformation ε_p . In the second stage there is constant speed rise $\varepsilon_p / d\theta = \text{const}$. The third stage reveals a very rapid increase in plastic deformation, which leads to the destruction of the element.

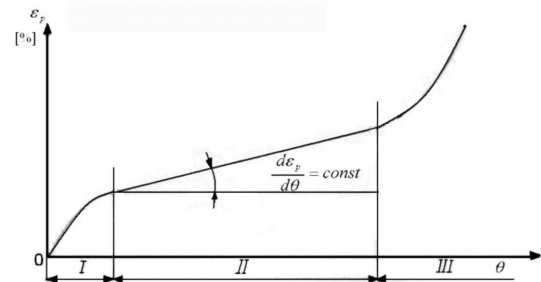

Fig. 7. The qualitative picture of the curve creep loaded machine components as a function of time

Destruction of fatigue is due to the gradual propagation of microcracks (Fig. 8).

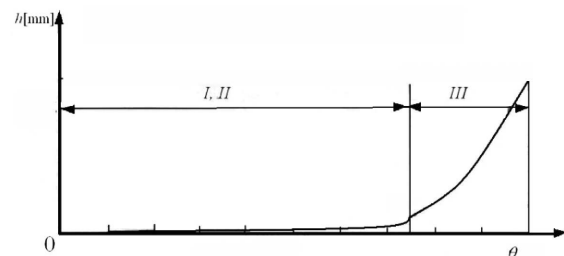

Fig. 8. The depth of fatigue cracks in the material as a function of operating time

These processes are closely related to the vibration levels (arising from the mass loss of plastic deformation, and the fatigue damage). For rolling bearings there is a general quality criterion, which is defined by specific indicators. Some of these indicators become apparent only during the operation, for example, bearing life (assuming correct installation in the machine bearings and lubrication, this ratio can be equated with the quality of brand new bearings). Bearing life is calculated in function of the environment, taking potential contamination hazards into account, and in virtue of the

expected number of cycles of rotation confronted with a combination of radial and axial loads (static and dynamic). This quality depends on the material, method of manufacturing the bearing, as well as its construction. It can be described with the following indicators:

T-is the time of durability in the pre-selected working conditions. Durability of the hypothesis of damage accumulation Miner is inversely proportional to the vibration level, namely: $T \sim V^{-1}$

D- deviation of the instantaneous center of the bearing from the working position can be also described as accuracy. Accuracy is also related to the vibration amplitude: $D \sim V^{-1}$

R are the resistance movement as a torque that is required to maintain a constant selected rotation. While bearing drag torque is directly proportional to the vibration acceleration level: $R \sim V$

V-vibration that generates the bearing (displacement, acceleration, and velocity).

H is the level of noise generated by the the bearing. There is also a relationship that occurs between the level of noise and vibration velocity or acceleration of the outer ring: $H \sim V$.

Thus defining criterion of quality bearings Q as weighted sum of indicators that can be obtained:

$$Q = aT + bD + cR^{-1} + dH^{-1} + eV^{-1} = aV^{-1} + bV^{-1} + cV^{-1} + dV^{-1} + eV^{-1} \quad (1)$$

where a, b, c, d, e determine the weighting factors.

The quality of the bearing determines, therefore, among other things, the level of vibration. Vibration level is determined by factors bearing new materials, design and technology [28].

The purpose of diagnostic tests is to determine the technical condition of the bearings and estimation of the trouble-free operation time. Observing the acceleration can be diagnosed the technical condition of the bearing. Different types of defects determine different vibration frequency. The largest can be observed when the damage is in the inner raceway of the bearing. For a single fault is generated characteristic frequency resulting from the following formula:

$$f = \frac{n}{2} f_r \left(1 + \frac{d}{D} \cos \beta\right) \quad (2)$$

where:

n – number of rolling elements of the bearings for single row,

f_r – Rotational speed which the bearing is mounted,

d – The diameter of the rolling element,

D – The diameter of the circle containing the axes of rotation of the rolling elements,

β – Angle between the axis of the shaft and the axle bearings,

Assuming that the angle of the bearing is relatively small $\beta \approx 1$, and the diameter ratio $d/D \approx 2$, are obtained:

$$f = \frac{n}{2} f_r \left(1 + \frac{1}{2}\right) = \frac{3}{4} n f_r \quad (3)$$

To estimate the frequency of the vibration excitation, it is assumed that the number of defects is equal to the number of rolling elements:

$$f_s = n f = \frac{3}{4} n^2 f_r \quad (4)$$

Noise phase lasts from the new bearings fitted to the creation of the first macro-failure. Broadband noise is a symptom of the vibration of new bearings. As the propagation of vibration damage narrows the band around the natural frequency of the bearing element, optionally the cover. With further job, the losses will reduce the average mass oscillation frequency and will increase and accelerate the peak. When the bearing is working on his clearances become larger, to the extent that the value of vibration acceleration and the average frequency decreases, while the displacement of the pivot as a vibration phenomenon becomes dominant.

During thermal deformation and weight of the bearing losses become so large that they cause a significant increase in resistance to motion, which leads to a substantial increase in bearing temperature during operation.

5. Results of research

For the identification of the symptoms of the defects in the vibration signal the analysis of time realization and frequency transformation of the vibration have been conducted.

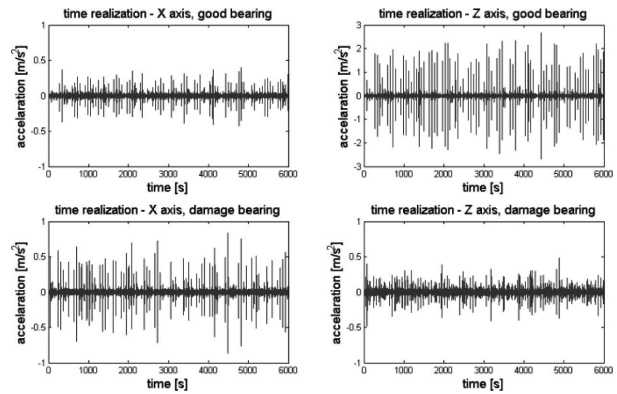

Fig. 9. Comparison of vibration signals registered on casing of good technical condition and damage bearings in X and Z axes (drive shaft – 496 rpm, bearing shaft 177rpm)

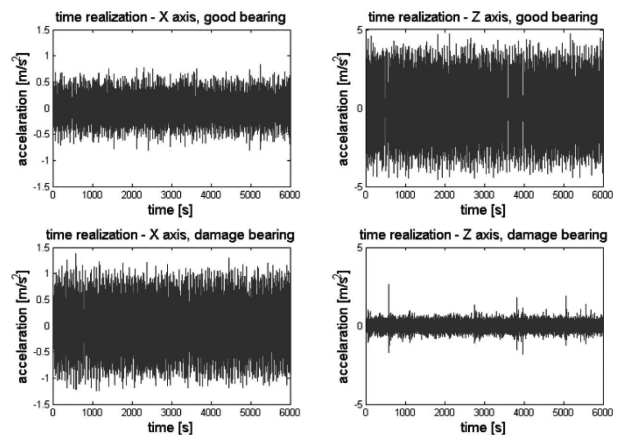

Fig. 10. Comparison of vibration signals registered on casing of good technical condition and damage bearings in X and Z axes (drive shaft – 2296 rpm, drive shaft – 820 rpm)

The paper presents results of vibration measurement during constant frequency (or rpm) states of working. The signals are not perfectly stationary. Thus it is better to observe the signal simultaneously in time and frequency domains [19-21].

For this purpose the spectrograms were determined. Spectrograms computes the short-time Fourier transform of a signal by default, x is divided into segments. During the transformation the Hamming window and noverlap were used. Noverlap is the value that produces 50% overlap between segments.

Results of the vibration registered on casing of good technical condition and damage bearings in two orthogonal axes have been depicted in Figures below.

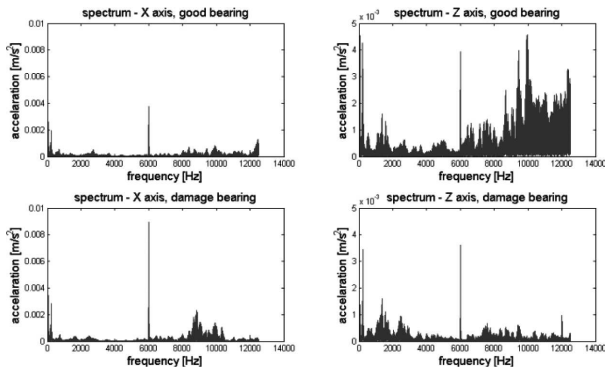

Fig. 11. Comparison of spectrums of vibration signals registered on casing of good technical condition and damage bearings in X and Z axes (drive shaft – 496 rpm, bearing shaft 177rpm)

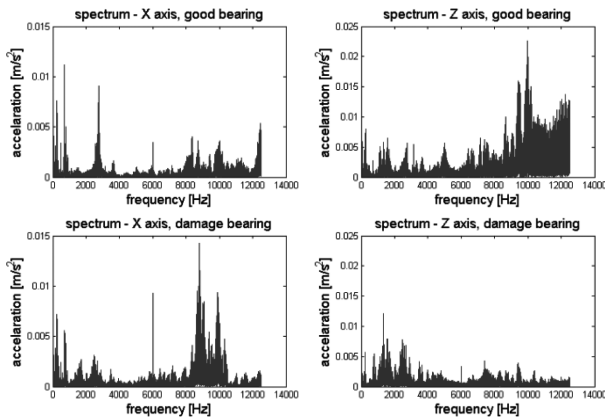

Fig. 12. Comparison of spectrums of vibration signals registered on casing of good technical condition and damage bearings in X and Z axes (drive shaft – 2296 rpm, drive shaft – 820 rpm)

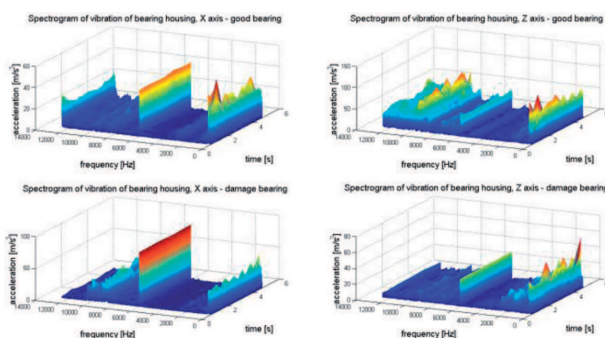

Fig. 13. Comparison of spectrograms of vibration signals registered on casing of good technical condition and damage bearings in X and Z axes (drive shaft – 496 rpm, bearing shaft 177rpm)

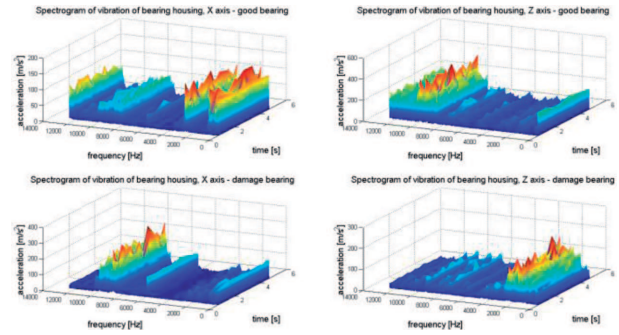

Fig. 14. Comparison of spectrograms of vibration signals registered on casing of good technical condition and damage bearings in X and Z axes (drive shaft – 2296 rpm, drive shaft – 820 rpm)

For the purpose of comparison and analysis of technical condition changes symptoms of vibration signals some comparison have been presented. The changes of the energy of the signal have been compared as the root mean square (RMS) values.

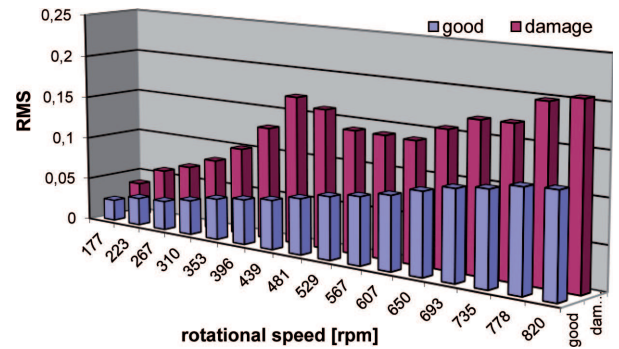

Fig. 15. Comparison of RMS of good and damage bearing in X axis

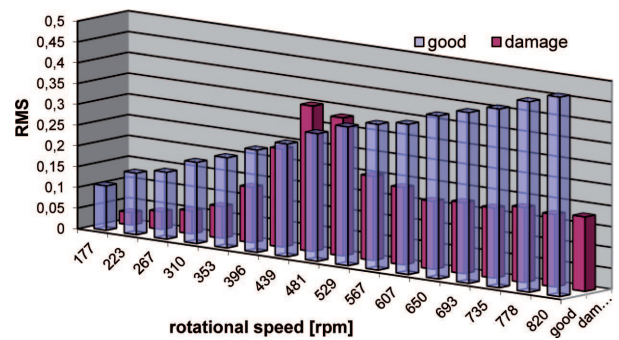

Fig. 16. Comparison of RMS of good and damage bearing in Z axis

6. Conclusions

The paper presents chosen results of active diagnostics experiments on research on influence of fatigue metal damage of the inner race of bearing on vibration in different frequencies. It can be considered as case study on application of vibroacoustics methods for technical condition monitoring. Proper evaluation of the technical condition is possible only for the correct separation of the information in diagnostics signals. If the diagnostic signals are the results of vibration propagation it has to be consider the material properties and the metallurgical process [22-32]. For the vibration signal analysis

it is important to observe signal in time and frequencies domains. For the results of the experiments the presented analysis showed dominant component of the vibration and time of the excitation. It can be observed the increase of the signal for chosen frequency band for the damage bearing. The 2-D time and frequency distributions of the signals shows many of properties of the element. But to improve the sensitivity of the diagnosis the spectrograms transformation of the vibration are much better. It allows observing the changes of the dominant components of the dynamics of vibration during time of operating of machine. Thus the changes of the dominant frequencies can be observed. Comparison of RMS of vibration for increase of rotational speed shows interesting results. For the vibration in direction along the shaft it can be assumed constant increase of the energy of the vibration and higher values for vibration of damage bearing. This trends cannot be confirmed by the results of vibration in direction vertical perpendicular to the shaft. The vibration of the bearing in good technical condition are higher. For the vibration of damage bearing the maximum values of RMS can be observed for rotational speed in range of 400-500 rpm.

REFERENCES

- [1] T. Uhl, The use and challenge of modal analysis in diagnostics, *Diagnostyka* **30**(2), 151-160 (2004).
- [2] M. Jasiński, S. Radkowski, Use of bispectral-based fault detection method in the vibroacoustic diagnosis of the gearbox, *Engineering Asset Lifecycle Management* 651-660 (2010).
- [3] R. Burdzik, Z. Stanik, J. Warczek, Method of assessing the impact of material properties on the propagation of vibrations excited with a single force impulse, *Archives of Materials and Metallurgy* **57**(2), 409-416 (2012).
- [4] C. Cempel, Singular values of symptom observation matrix of a system in operation as indicators of system damage, *Diagnostyka – Diagnostics and Structural Health Monitoring* **4**(60), 27-38 (2011).
- [5] R. Michalski, S. Wierzbiński, An analysis of degradation of vehicles in operation. *Maintenance and Reliability* **1**(37), 30-32 (2008).
- [6] B. Pojawa, Tests of LM2500 naval gas turbine with the objective of determining its operating characteristics, *Diagnostyka – Diagnostics and Structural Health Monitoring* **4**(60), 65-70 (2011).
- [7] A. Grządziela, Modelling of propeller shaft dynamics at pulse load, *Polish Maritime Research* **15** (4), 52-58 (2008).
- [8] T. Figlus, A. Wilk, Comparison of the sound pressure measurement and the speed measurement of the gearbox vibrating surface, *Journal of Transport Problems* **7**(1), 37-42 (2012).
- [9] J. Tůma, J. Šimek, J. Škuta, J. Los, Active vibrations control of journal bearings with the use of piezoactuators, *Mechanical Systems and Signal Processing* **36**(2), 618-629 (2013).
- [10] Z. Lozia, Truck front wheels and axle beam vibrations. 5th Mini Conference on Vehicle System Dynamics, Identification and Anomalies(VSDIA 96), Budapest, Hungary (1996).
- [11] A. Bubulis, G. Reizina, E. Korobko, V. Bilyk, V. Efremov, Controllable vibro-protective system for the driver seat of a multi-axis vehicle, *Journal of Vibroengineering* **13**(3), 552-557 (2011).
- [12] R. Burdzik, Monitoring system of vibration propagation in vehicles and method of analysing vibration modes. J. Mikulski (Ed.) TST 2012, CCIS 329 Springer, Heidelberg, 406-413 (2012).
- [13] R. Burdzik, Research on structure and directional distribution of vibration generated by engine in the location where vibrations penetrate the human organism, *Diagnostyka* **14**(2), 57-61 (2013).
- [14] R. Burdzik, Material vibration propagation in floor pan, *Archives of Materials Science and Engineering* **59** (1), 22-27 (2013).
- [15] J. Korzeb, M. Nader, J. Rózewicz, Review and estimation of traffic generated vibration developed in proximity of Warsaw subway line, 12th International Congress on Sound and Vibration 2005, ICSV 5048-5055 (2005).
- [16] K. Ragulskis, K. Kanapeckas, R. Jonušas, K. Juzėnas, Vibrations generator with a motion converter based on permanent magnet interaction, *Journal of Vibroengineering* **12**(1), 124-132 (2010).
- [17] M. Ragulskis, V. Kravčėnkiene, K. Pilkauskas, R. Maskeliunas, L. Zubavičius, P. Paškevičius, Calculation of stresses in the coating of a vibrating beam, *Journal of Vibroengineering* **11**(4), 707-711 (2009).
- [18] R. Zimroz, W. Bartelmus, T. Barszcz, J. Urbanek, Wind turbine main bearing diagnosis – A proposal of data processing and decision making procedure under non stationary load condition, *Key Engineering Materials* **518**, 437-444 (2012).
- [19] J. Dziurdź, Transformation of nonstationary signals into pseudostationary signals for the needs of vehicle diagnostics, *Acta Physica Polonica A*, **118** (1), 49-53 (2010).
- [20] Z. Dąbrowski, P. Deuszkiewicz, Designing of high-speed machine shafts of carbon composites with highly nonlinear characteristics, *Key Engineering Materials* **490**, 76-82 (2011).
- [21] L. Blacha, G. Siwiec, B. Oleksiak, Loss of aluminium during the process of Ti-Al-V alloy smelting in a vacuum induction melting (VIM) furnace, *Metalurgija* **52** (3), 301-304 (2013).
- [22] B. Oleksiak, G. Siwiec, A. Blacha-Grzechnik, Recovery of precious metals from waste materials by method of flotation process, *Metalurgija* **52**(1), 107-110 (2013).
- [23] G. Siwiec, B. Oleksiak, A. Smalcerz, J. Wiczorek, Surface tension of Cu-Ag alloys, *Archives of Materials and Metallurgy* **58** (1), 193-195 (2013).
- [24] B. Szczucka-Lasota, B. Formanek, A. Hernas, Growth of corrosion products on thermally sprayed coatings with FeAl intermetallic phases in aggressive environments, *Journal of Materials Processing Technology* **164-165**, 930-934 (2005).
- [25] B. Szczucka-Lasota, B. Formanek, A. Hernas, K. Szymański, Oxidation models of the growth of corrosion products on the intermetallic coatings strengthened by a fine dispersive Al₂O₃, *Journal of Materials Processing Technology* **164-165**, 935-939 (2005).
- [26] T. Węgrzyn, J. Piwnik, B. Łazarz, D. Hadryś, Main micro-jet cooling gases for steel welding. *Archives of Materials and Metallurgy* **58**(2), 551-553 (2013).
- [27] A. Lisiecki, Diode laser welding of high yield steel. *Proceedings of SPIE, Laser Technology, Applications of Lasers* **8703**, 22 (2012).
- [28] C. Cempel, The global and partial system condition assessment in multidimensional condition monitoring, *Diagnostyka* **4**(52), 23-34 (2009).
- [29] R. Burdzik, Ł. Konieczny, Research on structure, propagation and exposure to general vibration in passenger car

- for different damping parameters, *Journal of Vibroengineering* **15**(4), 1680-1688 (2013).
- [30] R. Burdzik, Research on the influence of engine rotational speed to the vibration penetration into the driver via feet – multidimensional analysis, *Journal of Vibroengineering* **15**(4), 2114-2123 (2013).
- [31] Ł. Konieczny, R. Burdzik, B. Łazarz, Application of the vibration test in the evaluation of the technical condition of shock absorbers built into the vehicle, *Journal of Vibroengineering* **15**(4), 2042-2050 (2013).
- [32] G. Golański, J. Słania, Effect of different heat treatments on microstructure and mechanical properties of the martensitic GX12CrMoVNbN9-1 cast steel, *Archives of Materials and Metallurgy* **58**(1), 25-30 (2013).

Received: 20 January 2014.