

## THE INFLUENCE OF TEMPERATURE ON ERRORS OF WIM SYSTEMS EMPLOYING PIEZOELECTRIC SENSORS

Janusz Gajda<sup>1)</sup>, Ryszard Sroka<sup>1)</sup>, Tadeusz Zeglen<sup>1)</sup>, Piotr Burnos<sup>1)</sup>

1) AGH University of Science and Technology, Al. A. Mickiewicza 30, 30-059 Krakow, Poland (✉ jgajda@agh.edu.pl)

### Abstract

The paper provides analysis of the influence of temperature on the error of weigh-in-motion (WIM) systems utilizing piezoelectric polymer load sensors. Results of tests of these sensors in a climatic chamber, as well as results of long-term tests at the WIM site, are presented. Different methods for correction of the influence of changes in temperature were assessed for their effectiveness and compared.

Keywords: piezoelectric sensors, temperature influence, temperature error of WIM systems, error correction.

© 2013 Polish Academy of Sciences. All rights reserved

### 1. Introduction

Protection of road infrastructure, prediction of the rate of road pavement deterioration, improvement of road traffic safety and maintaining conditions for fair competition for haulage companies, require monitoring of vehicles' parameters and elimination of overloaded vehicles from the road. Overloading means that the axle, or axle group load or the gross vehicle weight (GVW) exceeds permissible values specified in a given country.

One of the tools for vehicles' mass and axle load control are weigh-in-motion (WIM) systems. The WIM system comprises load sensors placed in the road pavement and oriented perpendicularly to the direction of weighed vehicles motion. Depending on the number of sensors two categories of WIM systems are distinguished: two-sensor or multiple sensor systems. Load sensors co-operate with conditioning systems, measurement data acquisition and computer systems. Aiming for high effectiveness of detection and elimination of overload vehicles from roads has lead to development and large-scale implementation of WIM systems.

The idea of WIM systems operation is measuring dynamic loads exerted by a moving vehicle wheels on the road pavement and sought static loads, as well as gross vehicle weight estimation [1].

There are several factors which may affect piezoelectric WIM sensors' accuracy such as vehicle speed, vehicle class, wheel path, pavement temperature, soil moisture etc. As a result, piezoelectric sensors have different performances in different parts of the world such as the U.S., Poland, Australia, Africa etc., since these locations have different climates and temperature patterns to which the sensors respond differently [2].

The accuracy of weighing results collected in WIM systems, influences the effectiveness of elimination of overload vehicles from roadways. It also influences the quality of assessment of road pavement strength, repair planning (depending upon the mass of the transported load), development of traffic models and evaluation of economic parameters computed for, e.g. statistical purposes.

Aiming for improving the WIM systems accuracy, enforced by the above requirements, justifies research into this field to answer the question: which factors disturb the accuracy of weighing?

The prevailing opinion is that the major source of errors are vertical oscillations of a vehicle passing through a WIM site. This phenomenon is illustrated in Fig. 1 which shows the dynamic component of a single axle load, with respect to the static load of this axle, of a vehicle moving over a good road at a speed of 80 km/h. As follows from the figure, in the worst case (WIM system equipped with a single line of load sensors), the weighing relative error can amount to even 40%.

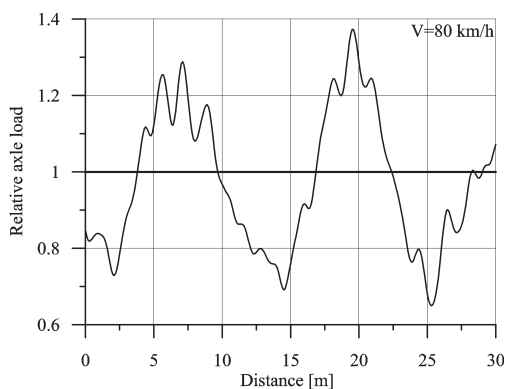

Fig. 1. Relative changes in the vehicle instantaneous axle load at the speed of 80 km/h.

Oscillations of the weighed vehicle are the factor limiting the WIM system weighing accuracy, which is independent (or it depends to only a small extent) on the load sensors' design.

There is, however, an interrelation between the type of pavement in which the sensors are installed and the influence of weather factors, such as humidity and temperature changes, the sensors' type and technology of their manufacturing. The effect of these factors should be analyzed individually for each WIM site taking into consideration the materials used for pavement construction at the installation site [3].

The evaluation verified that the piezoelectric quartz sensor technology has the best weight measurement accuracy and insensitiveness to temperature change. However, this performance comes at a higher cost than the other sensors.

Research is being directed to improve the other sensors' performance with inexpensive auto-calibration or compensation methods based on temperature measurements.

This work provides an analysis of the influence of temperature on changes in the parameters of piezoelectric sensors manufactured by Measurement Specialties Inc. (MSI) and vehicle weighing errors arising from these changes [3],[4].

Further reasons for addressing this issue, apart of high sensitivity of piezoelectric sensors to temperature changes, are:

- low awareness among WIM system users of the system limitations and the necessity to exercise considerable caution when interpreting weighing results acquired from systems having no temperature correction,
- the possibility of temperature effect correction.

## 2. Technologies utilized in WIM systems

For the purpose of improving static weight estimation of WIM systems, many new types of sensors, such as Fiber Optic Sensors and strain gauges have been developed in WIM applications. Simultaneously there is an evolution in the technology of piezoelectric weigh-in-motion sensors. There is an industry movement away from encapsulated sensors with more emphasis on unencapsulated WIM sensors. Many countries are replacing the Thermocoax/Vibrocoax WIM sensors with Brass Linguini (BL) sensors marketed by Measurement Specialties Inc. These new BL sensors required a smaller groove to be cut in the pavement and typically produce a higher output [5]. However, traditional pressure sensors such as piezoelectric sensors, bending plates and load cells still play very important roles in this technology [6].

Piezo-ceramic, piezo-polymer and piezo-quartz sensors are three widely used piezoelectric sensors:

1. Roadtrax<sup>®</sup> Brass Linguini<sup>®</sup> (BL) axle polarized polyvinylidene fluoride (PVDF) WIM sensor made by Measurement Specialties, Inc. (MSI) [4]. The sensor and method of its installation are depicted in Fig. 2.
2. Piezolor<sup>®</sup> type PE polarized ceramic WIM sensor made by Electronique Contrôle Mesure [7];
3. Lineas<sup>®</sup> quartz piezoelectric Type 9195E WIM sensor made by Kistler Instrumente AG [8].

These sensors are different in shape, dimension, cost and sensitivity to environmental conditions.

a) scheme of the wheel – sensor interaction,

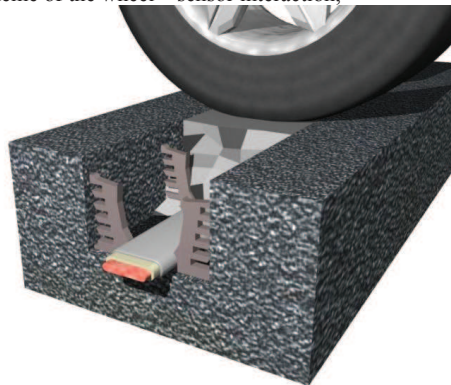

b) sensor during the installation process.

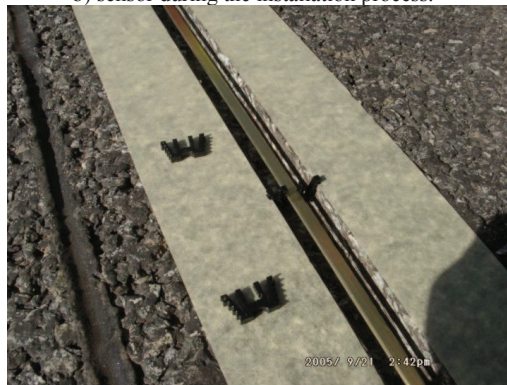

Fig. 2. The MSI Roadtrax BL load sensor:

The relatively low cost of piezoelectric polymer sensors is the reason for their popularity and widespread application in WIM systems. This in turn justifies scientific research and engineering aimed at improving the accuracy of WIM systems utilizing such sensors [6].

### 2. Piezoelectric polymer sensor and its model

Due to the method of installation of piezoelectric polymer sensors, the road pavement takes part in transferring the vehicle wheel load onto the sensor (Fig. 2a). This fact considerably influences metrological properties of WIM systems employing these sensors. A continuous

voltage signal at the sensor output is generated during the time interval when a vehicle wheel rolls over the sensor. In the measuring system employing a piezoelectric polymer sensor the signal is shaped, sampled and converted to digital form. An exemplary load signal  $U_s$  is shown in Fig. 3. When passing through the sensor and the conditioning system the signal undergoes deformation. The extent of the  $U_s$  signal deformation depends on parameters of both: the sensor and the conditioning system. Signals  $U_o$  at the conditioning system output, corresponding to different sensor capacity  $C_s$  values, are depicted in Fig. 3.

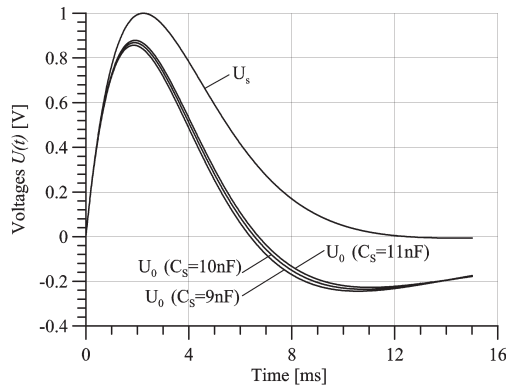

Fig. 3. Exemplary waveforms of the load signal from piezoelectric polymer sensor.

The equivalent circuit (model) of a piezoelectric polymer sensor with the input part of conditioning system is shown in Fig. 4 [3]. It takes into account the sensor capacity  $C_s$ , serial resistance  $R_s$ , parallel resistance  $R_{DC}$ , the “perfect” source  $U_s$  and the input resistance of the sensor conditioning circuit  $R_i$ .

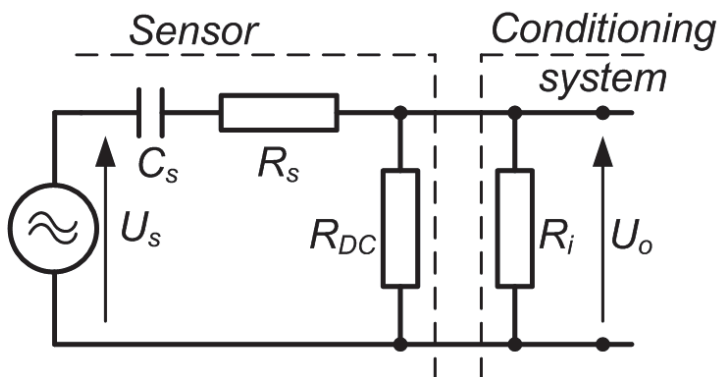

Fig. 4. The equivalent circuit (model) of a piezoelectric polymer sensor and the input part of conditioning system waveforms of the load signal from piezoelectric polymer sensor.

In order to compute the axle load value  $W$  the signal  $U_o$  is processed according to algorithm (1) provided by the sensor manufacturer.

$$W = k \cdot V \cdot \tau \cdot \int_0^{\tau} U_0(t) dt \tag{1}$$

where:

- $\tau$  – the signal duration time (when  $U_0(t) > 0$ ),
- $k$  – calibration coefficient,
- $V$  – vehicle speed.

Since the equivalent parameters of the input part of the measuring system are constant, and their adverse impact can be to a large extent limited during the measurement path calibration, the equivalent parameters of the sensor itself undergo changes due to environmental factors. Particularly important is the influence of the sensor operating temperature.

Changes in the dielectric constant of the sensor material versus temperature, as determined by the sensors manufacturer, are shown in Fig. 5. [4]. It follows that with changes in temperature the sensor capacitance is changing and, consequently, the output signal waveform also undergoes changes (Fig. 3).

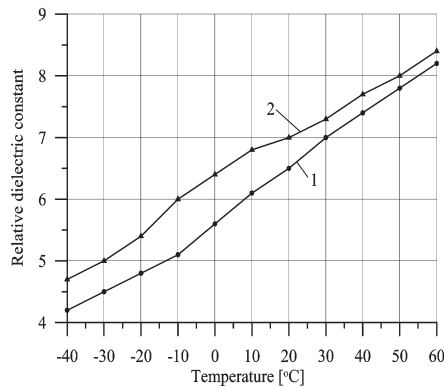

Fig. 5. Dielectric constant of piezoelectric polymer sensors' material versus temperature; measurement results at the frequency of : 1 - 1kHz, 2 - 10kHz.

The strong influence of temperature on the weighing error in WIM system employing piezoelectric polymer sensors is also emphasised in the paper [6]. The results presented confirm that the polymer sensor and the ceramic sensor are considered to be temperature sensitive, while the quartz sensor is designed to be insensitive to temperature. The ceramic sensor is most sensitive to pavement temperature, the polymer sensor is less sensitive to temperature compared with the ceramic sensor, and the quartz sensor seems to be independent of temperature. However the temperature change in the range from 10.2°C to 36.7°C causes the 40.7% changes in GVW estimates based on the polymer sensor signal (see Table 1).

Similar conclusions were reached by the authors of papers [9, 10, 11, 12, 13], who investigated the behavior of MSI sensors installed in both the asphalt and concrete pavements.

This problem is also addressed in [14]. The paper describes the laboratory and field tests of the Roadtrax BL sensor manufactured by MSI. During these tests the effect of pavement temperature on the output signal of the sensors installed in asphalt concrete was also examined. In general, all of the examined Roadtrax BL sensors showed an increase in signal amplitude with increased pavement temperature. The coefficient described this relationship expressed in volts per degree Celsius is as high as 0.162. With the data obtained during these tests it was not possible to tell if the increase in amplitude is from a decrease in pavement stiffness or due to temperature affecting the thermal properties of the sensor.

Table 1. Average GVW [kg] estimation at different pavement temperatures [6].

Time	Average temperature	MSI	
		GVW	Error
8:00-8:30	10.2°C	2077	-25.3%
9:00-9:30	15.8°C	2427	-12.7%
10:00-10:40	22.2°C	2767	-0.5%
11:30-12:15	29.0°C	3039	9.3%
13:00-13:45	34.4°C	3239	16.5%
14:30-15:00	36.7°C	3207	15.4%
15:30-16:00	35.1°C	3189	14.7%
16:25-17:30	31.6°C	3012	8.3%

From the point of view of constructors and users of WIM systems utilizing piezoelectric sensors it is however essential to answer the question how the sensors dependence on temperature affects weighing errors, and is this influence the sole one? The goal of this work is to answer both these questions. The basis for seeking the answer are experimental tests of sensors in a climatic chamber and results of several years' observation at the WIM test site equipped with piezoelectric polymer sensors.

### 3. Experimental investigation

The primary objective of experimental investigation was determining the influence of temperature on changes of the piezoelectric sensor equivalent parameters and, consequently, on change in the accuracy of weighing results (simulation tests using the sensor model). Experiments were carried out in a climatic chamber and at the WIM test site installed on a roadway.

Under climate conditions prevailing in Poland, the changes in the road pavement temperature, measured at the depth of several centimetres, are usually contained in the range of  $-15 \div +50^\circ\text{C}$  (Fig. 6). However, the occurrence of exceptionally cold days, when air temperature drops below  $-35^\circ\text{C}$  at night, and the pavement temperature below  $-20^\circ\text{C}$ , cannot be excluded.

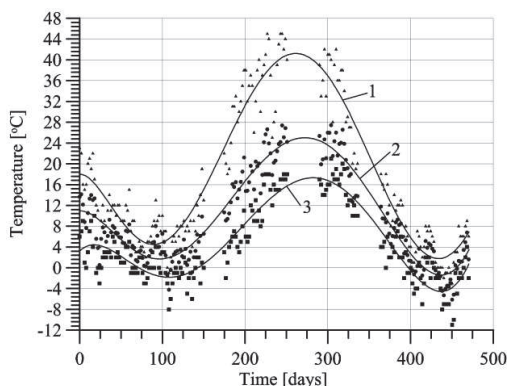

Fig. 6. Changes in the pavement temperature in the south of Poland during a 16-month period. 1 – maximum daily temperature, 2 – average daily temperature, 3 – minimum daily temperature.

Tests carried out in the climatic chamber allowed determining the influence of temperature on the sensor capacitance  $C_s$  and dissipation factor  $\text{tg}(\delta)$  given in formula (2). The measurements were made for two sensors of the same type. In the first case only the sensor was placed in the chamber, whereas in the second case the sensor with the cable connecting it to the measuring system. The measurement results of the sensor equivalent parameters are shown in Figure 7 (characteristics of the sensor) and Figure 8 (the sensor with connecting cable). The measurements were performed over the temperature range from  $-30^\circ\text{C}$  to  $+50^\circ\text{C}$ , according to the requirements of standard [1].

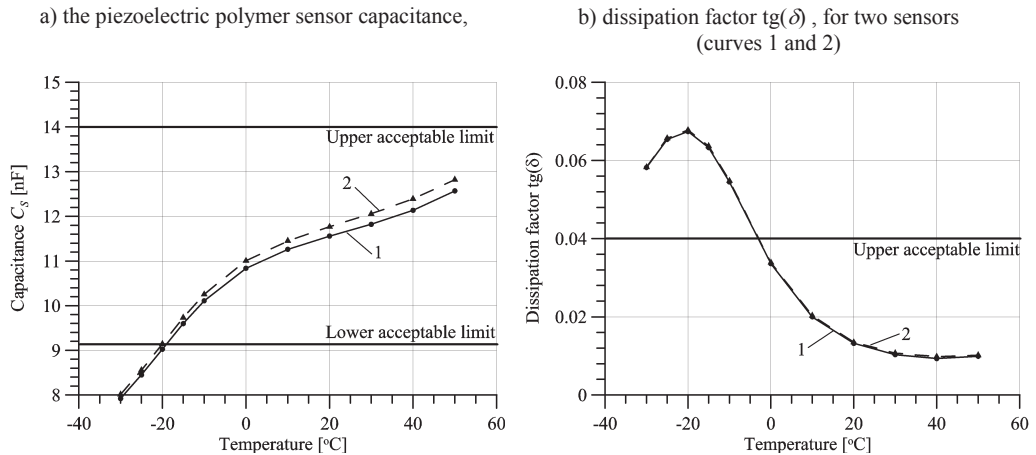

Fig. 7. The influence of temperature on:

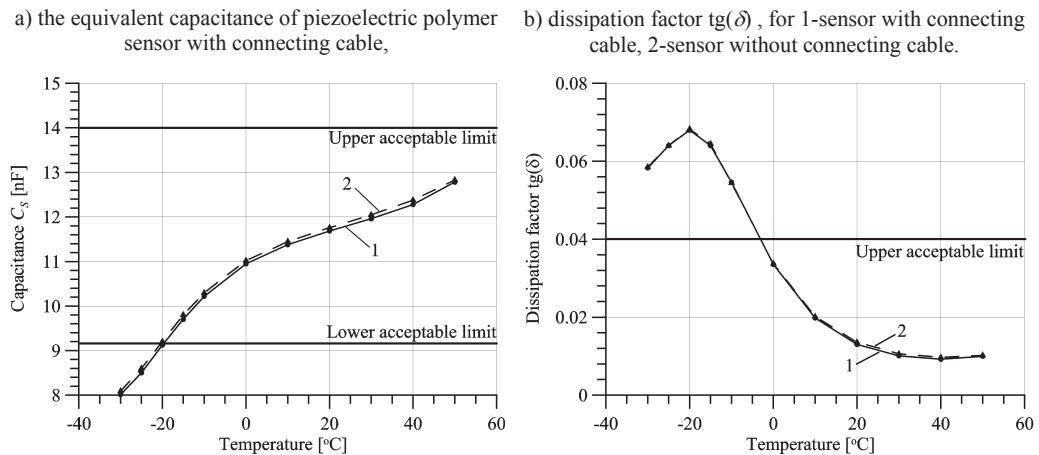

Fig. 8. The influence of temperature on:

#### 4. Discussion

Two conclusions can be inferred from characteristics shown in Figures 7 and 8. Firstly, the source of changes in the model parameters is the sensor itself. Cables connecting the sensor with the measuring system do not contribute significantly to this effect. Secondly, under the



influence of low temperatures the sensor equivalent parameters exceed limits of changes permitted by the sensor manufacturer.

But for a user of the WIM system equipped with piezoelectric polymer sensors the answer to a different question is essential: how large will be weighing error due to observed changes in the sensor equivalent parameters, even if they are contained within the permissible interval of changes?

The values of the resistance  $R_S$  for different temperatures can be computed from the equivalent circuit shown in Figure 4 using relation (2), assuming the resistance  $R_{DC}$  value remains constant, equal to  $100\text{M}\Omega$  and utilizing the results of the capacitance  $C_S$  and dissipation factor  $\text{tg}(\delta)$  measurements:

$$\text{tg}(\delta) = \frac{1 + (\omega C_S)^2 R_S (R_S + R_{DC})}{\omega R_{DC} C_S} \quad (2)$$

where:  $\omega$  is the angular frequency at which the sensor parameters were measured.

Thus to each temperature value there correspond three values of the sensor equivalent parameters  $[C_S, R_S, R_{DC}]$ . For calculation purposes a constant resistance value  $R_i = 1\text{M}\Omega$  of the measuring system input part was taken.

Simulations were carried out for the circuit from Figure 4 excited with the input signal  $U_s$ , while the circuit response  $U_0$  was computed. For various temperatures of the sensor different waveforms of the output signal  $U_0$  were obtained. Figure 3 shows several examples of waveforms with indicated corresponding values of the capacitance  $C_S$ .

Signals  $U_0$  were processed according to algorithm (1) yielding weighing results  $W$  for specified parameters of the algorithm and a given temperature value. The weighing error arises from the difference between the actual sensor temperature value and the reference temperature value at which the WIM system was calibrated (the reference temperature was  $+20^\circ\text{C}$ ). The relative value of error is computed from relation (3).

$$\text{relative error} = \frac{W - W_0}{W_0} \cdot 100\% \quad (3)$$

where:

$W_0$  - the result of processing according to algorithm (1) for temperature  $+20^\circ\text{C}$ .

The plot of error (3) versus the sensor temperature is shown in Figure 9. As follows from this characteristic the temperature rise of  $20^\circ\text{C}$  over the reference temperature results in a weighing error of about 4%. At extremely low temperatures this error may be contained within the range 10-20%.



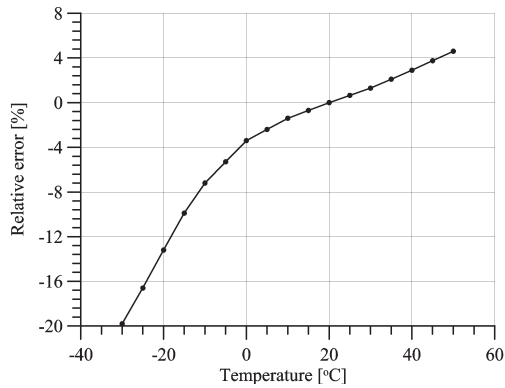

Fig. 9. The weighing error in the WIM system equipped with piezoelectric polymer sensors, arising exclusively from a change in the sensor parameters due to a change in temperature.

Load sensors are installed in the asphalt or concrete road pavement. Regarding the method of installation it should be presumed that the pavement mechanical properties, and specifically their changes with temperature, could also influence the correctness of weighing. This influence can only be evaluated in the way of on-site experiments carried out at the WIM site.

Figure 10 shows the relative error of the result of weighing a reference vehicle versus temperature over the range of temperature changes from  $-10^{\circ}\text{C}$  to  $+30^{\circ}\text{C}$ . The WIM site was installed in asphalt. The changes in the error value are the total effect of changes in the sensor parameters and in asphalt rigidity.

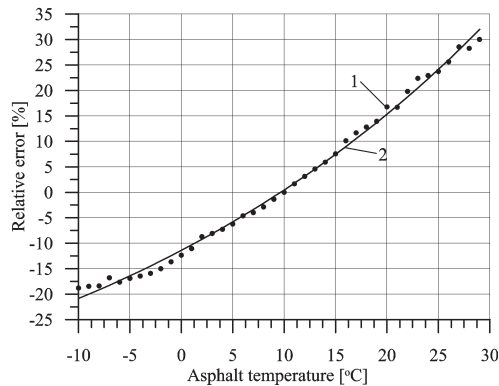

Fig. 10. The relative error of weighing a reference vehicle at different temperatures on WIM site installed in asphalt. 1 – experimental results, 2 – the model characteristic.

The results shown in Figure 10 (points 1) can be described with good accuracy by the model in the form of (4) [11] (curve 2).

$$C_T(T_a) = k_T \cdot 10^{w_r(T_a)} + b_T \quad (4)$$

where:

$T_a$  – asphalt temperature [ $^{\circ}\text{C}$ ],

$k_T = 0.4659$  – gain factor,

$w_T = 0.0098$  – sensitivity factor,  
 $b_T = 0.4199$  – offset.

Coefficients  $k_T$ ,  $w_T$ ,  $b_T$  depend on the asphalt components and should be determined separately for each site.

The knowledge of the model (4) enables online correction of the weighing error but it requires continuous measuring of the road pavement temperature at a depth similar to that at which the load sensors are installed. As follows from Figure 10 the relative weighing error in a WIM system where such correction has not been implemented may attain even 30%.

Fig. 11 shows the WIM system error versus temperature after the correction based on the model (4), of weighing results shown in Fig. 10.

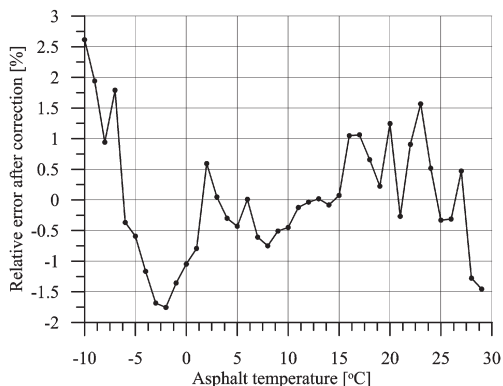

Fig. 11. The relative error of weighing in the WIM system after correction based on the model (4).

Nevertheless determination of the model (4) for a given WIM site is time-consuming and costly. Thus an alternative approach can be adopted that consists in calibration of WIM site at several selected temperatures, distributed uniformly over the range of temperature changes typical for the WIM system location.

Figure 12 shows the WIM system errors after temperature correction based on the calibration results for three temperature values (-10°C, +10°C and +30°C) and five temperature values (-10°C, 0°C, +10°C, +20°C and +30°C). As seen from the figure, the five-point calibration yields better results than the model (4) that covers the entire range of temperature changes.

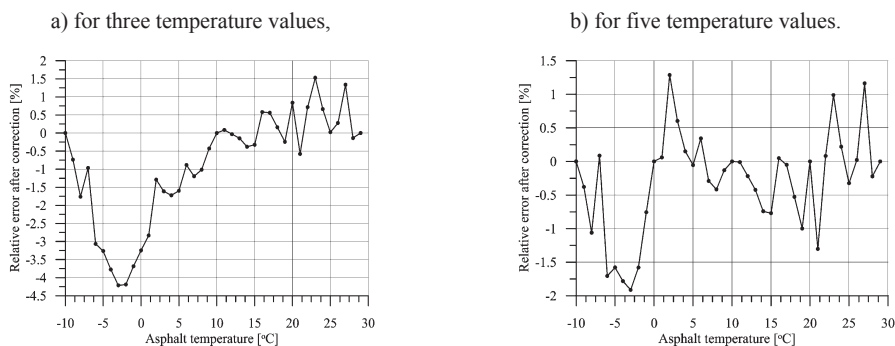

Fig. 12. The relative error of weighing in the WIM system after correction based on calibration:

## 5. Conclusions

The research results confirmed a considerable influence of temperature on vehicle weighing errors in a WIM system utilizing piezoelectric polymer load sensors. The errors arise from changes in parameters of both the sensor itself and the asphalt pavement in which the sensors are installed.

Under the climate conditions in Europe a value of the weighing error caused by a change in parameters of the sensor itself may attain up to 20%. For WIM sites installed in an asphalt pavement this error will be even greater and can attain 30%.

Maintaining acceptable metrological properties of WIM systems utilizing piezoelectric polymer sensors requires temperature correction of weighing results. The necessary condition for the correction effectiveness is continuous measurement of the pavement temperature at the depth at which load sensors are installed and experimental determination of the model that describes the dependence of weighing results on temperature for the given WIM site. Nevertheless a reliable determination of such model requires long-term site tests.

A simpler, yet equally effective solution is to perform WIM system calibration for several (3÷5) temperature values, uniformly distributed over the seasonal temperature changes interval, typical for the WIM system location. This allows limiting the weighing errors related to changes in the pavement temperature to  $\pm 2\%$  (what means that the relative error of weighing result  $W$  in the WIM system can be decreased even 10-fold after such correction).

The errors of vehicle weighing related to the influence of temperature are determinate (systematic) errors and, therefore, they cannot be effectively reduced by means of increasing the number of sensors in the system (unlike the errors arising from vertical oscillations of a passing vehicle). The only effective solution for this problem is to employ an appropriate correction.

## Acknowledgements

This work was supported by the Polish Ministry of Science and Higher Education funds in 2010 – 2013.

## References

- [1] ASTM International, 2009. Standard Specification for Highway Weigh-In-Motion (WIM) Systems with User Requirements and Test Methods. Designation: E 1318 – 09
- [2] Koniditsiotis, C. 2000. Weigh-in-Motion Technology, Austroads Incorporated, Sydney, Australia.
- [3] Gajda, J., et al., 2012. Analysis of the Temperature Influences on the Metrological Properties of Polymer Piezoelectric Load Sensors Applied in Weigh-in-Motion Systems. Proceedings of IEEE International Instrumentation and Measurement Technology Conference. Graz, pp. 772-775.
- [4] Roadtrax BL Traffic Sensors. 2001. Measurement Specialties Inc, Sensor Products Division.
- [5] Szary P.J., Maher A. 2009. Implementation of Weigh-in-Motion (WIM) Systems. Final report. FHWA-NJ-2009-001.
- [6] Jiang, X. 2009. Improvements in Piezoelectric Sensors and WIM Data Collection Technology. Innovations in Pavement Monitoring and Evaluation. Session of the 2009 Annual Conference of the Transportation Association of Canada, Vancouver, British Columbia
- [7] <http://www.ecm-france.com/gb/doc/index.php>
- [8] Kistler, 2011. Weigh-In-Motion, Lineas® WIM Sensor with Quartz Technology.

- [9] Papagiannakis, AT. et al., 2001. Laboratory and Field Evaluation of Piezoelectric Weigh-in-Motion Sensors. *Journal of Testing and Evaluation (JTE)*. Volume 29, Issue 6.
- [10] Papagiannakis A.T., Johnston, E.C., Alav, S. 2001. Fatigue Performance of Piezoelectric Weigh-in-Motion Sensors. *Transportation Research Record: Journal of the Transportation Research Board*. Volume 1769, pp. 87-94
- [11] Burnos P. 2008. Auto-calibration and temperature correction of WIM systems. *HVParis2008 – ICWIM5 : proceedings of the International conference on Heavy Vehicles : 5th International Conference on Weigh-in-Motion of Heavy Vehicles*. eds. Bernard Jacob [et al.]; Wiley, pp. 437–446.
- [12] Burnos, P., et al., 2007. Accurate weighing of moving vehicles. *Metrology and Measurement Systems*. vol. 14 no. 4, pp. 507–516.
- [13] Gajda, J., et al., 2007. Accuracy analysis of WIM systems calibrated using pre-weighed vehicles method. *Metrology and Measurement Systems*. vol. 14 no. 4, pp. 517–527.
- [14] HITEC, 2001. Evaluation of Measurement Specialties, Inc. Piezoelectric Weigh-In- Motion Sensors. Technical evaluation report, CERF Report: #40587.