

Z. GRONOSTAJSKI*#, M. KASZUBA*, H. PASCHKE**, T. ZAKRZEWSKI***, G. ROGALIŃSKI***

IMPROVEMENT OF TOOLS DURABILITY BY APPLICATION OF HYBRID LAYER OF NITRIDED/PECVD COATING.

POPRAWA TRWAŁOŚCI NARZĘDZI POPRZEZ ZASTOSOWANIE WARSTW HYBRYDOWYCH AZOTOWANIE/PECVD

In the process of die hot forging the tools are subjected to three main factors leading to their destruction: the intensive thermal shocks, cyclically variable mechanical loads and intensive friction. The above mentioned factors causing destruction in the process of hot forging and warm forging concern mainly the surface of tools. Hybrid technique nitrided/PECVD belong to the latest methods of modifying the properties of the surface layer. In the paper the application of this technique for forging tools of constant velocity joint body is presented. The durability of the new tools is much better than the tools applied so far.

Keywords: forging, tools, nitride, PVD, CVD

W procesach kucia matrycowego na gorąco narzędzia poddawane są działaniu trzech głównych czynników powodujących ich niszczenie, tj. intensywnym szokom cieplnym, cyklicznie zmiennym obciążeniom mechanicznym oraz intensywnemu tarcia. Wymienione czynniki powodują zniszczenie głównie warstwy powidzeniowej narzędzi, dlatego poszukuje się nowych metod podnoszących trwałość tej warstwy. Jednym z rozwiązań jest stosowanie technologii hybrydowych azotowanie/PECVD. W pracy przedstawiono zastosowanie takich warstw na narzędzia do kucia przegubów homokinetycznych. Badania wykazały, że narzędzia z warstwami hybrydowymi mają większą trwałość niż dotychczas stosowane.

1. Introduction

Durability of the tools used in the process of hot forging is mainly affected by the conditions of forging process, design and implementation tools, the proper heat treatment adequate to the selected tool material, shape preform, etc [1-3].

In the process of die hot forging the tools are subjected to three main factors leading to their destruction: the intensive thermal shocks, cyclically variable mechanical loads and intensive friction. In the process of the hot forging of steel in order to reduce the flow stress the formed material is heated up to 1000 ÷ 1200° C. The temperature of the tool in the surface layer heated by deformed material may periodically reach a value up to 800° C, then the tools are intensively cooled also in a cyclic way [4-6].

The above mentioned factors causing destruction in the process of hot forging and warm forging concern mainly the surface of tools [7, 8]. Therefore, the modifications of surface properties of forging tools are the most effective way to improve their durability. Design of properties of the tools' surface is possible due to the development of surface engineering methods and application of multilayer [9 -12].

From among the many techniques of increasing the durability of the surface of engineering materials the following are of major practical importance:

- physical vapour deposition (PVD) and
- chemical vapour deposition (CVD) [13].

Hybrid techniques

Research on hybrid surface treatment methods, carried out in many research centres, has resulted in the development of hybrid techniques combining two or more surface engineering processes. Owing to the combination and interaction of different processes one can obtain surface layer properties unattainable if the techniques were used separately [14, 15].

Hybrid layers of nitrided layer/PVD or CVD coating type

Hybrid techniques belong to the latest methods of modifying the properties of the surface layer. The best results in improving the durability of forging tools are achieved using hybrid techniques which combine thermal treatment methods and one of the PVD or CVD techniques. This technology enables one to impart proper service properties to a surface and to form a barrier which will effectively limit the effect of harmful factors.

* WROCLAW UNIVERSITY OF TECHNOLOGY, INSTITUTE FOR PRODUCTION ENGINEERING AND AUTOMATION, 5 IGNACEGO LUKASIEWICZA STR., 50-371 WROCLAW, POLAND

** FRAUNHOFER INSTITUTE FOR SURFACE ENGINEERING AND THIN FILMS, EBERHARDSTRASSE 12, D-44145 DORTMUND

*** GKN DRIVELINE OLEŚNICA, 18 POLUDNIOWA STR., 56-400 OLEŚNICA, POLAND

Corresponding author: zbigniew.gronostajski@pwr.wroc.pl

The most commonly used hybrid systems are of the nitrided layer/PVD or a CVD coating type. The multilayer systems consist of a properly prepared substrate (a nitrided layer) and a properly matched adhesion coating produced on the surface of the substrate. The nitrided layer alone would not sufficiently protect the surface layer of the tools against harmful factors, such as thermal shocks, intensive friction and heavy mechanical loads. The primary function of the nitrided layer is to increase the substrate's hardness and resistance to plastic deformation. This protects the hard PVD or CVD coating against the loss of its adherence to the substrate. PVD and CVD coatings effectively insulate the substrate from external harmful effects during service. Fig. 1 illustrates the function of the particular components of such a hybrid layer [16, 17].

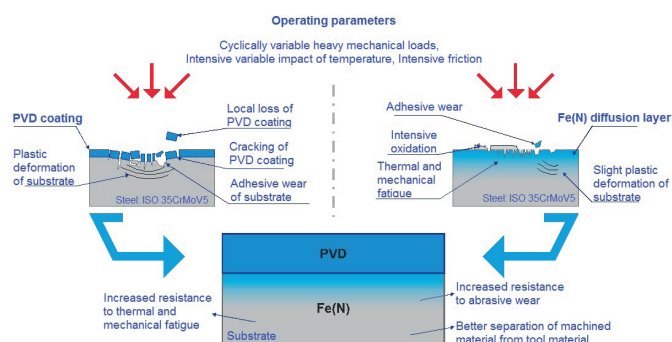

Fig. 1. Functions of particular components of hybrid layer of nitrided layer/PVD coating type [15]

Thanks to the interaction between the two structural components, i.e. the nitrided layer and the PVD or CVD coating, a surface layer with properties unattainable using each of the techniques separately is obtained [18].

The primary objective of this study was to improve the life of dies used in a second operation on the precision forging constant velocity joint (CVJ) body through the use of a hybrid systems of the nitrided layer/PECVD and describing and classification of devastating mechanisms occur in these dies.

2. Description of the process

The constant velocity joint body (CVJ body) transmit torque from the gearbox to the front wheel (Fig. 2).

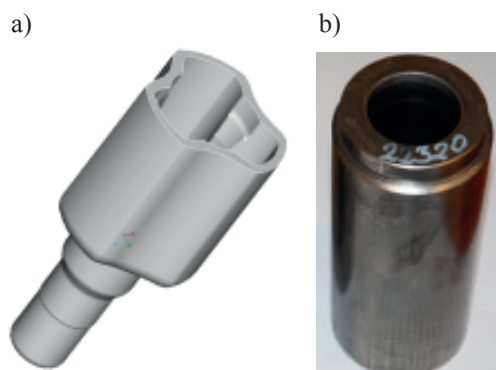

Fig. 2. Constant velocity joint body a) forging b) tools

The hot forging of the CVJ body consists of several operations. In considered processes there were four forging operations. In the first process the arched die and perform with diameter of 55 mm and height of 76.45 mm were used and in the second process the conical die and perform with diameter of 50 mm and height of 91.75 mm were applied. A scheme of the tools and preforms for different operation is shown in Fig. 3. The second operation is the most crucial as regards the durability of tools therefore it was analyzed in the paper. The process is described in more detail in [17, 18]. Operational studies of the dies used in the second operation of forging a CV joint were carried out in industrial conditions in the GKN Driveline Polska in Oleśnica.

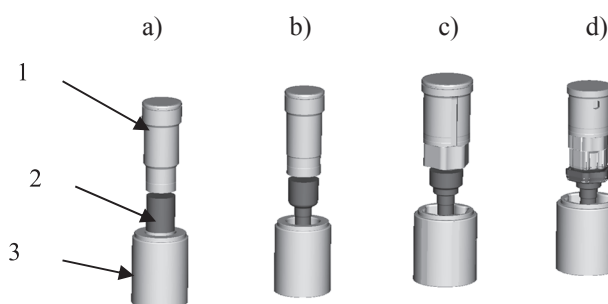

Fig. 3. Schematic of tools used in investigation of successive operations : 1 – punches, 2 – preforms, 3 – dies

The tools made of UNIMAX steel currently used in the forge, after 7044, 8731 and 17054 forgings and tools with hybrid layer after 5000, 23078 forgings were studied. The irregular number of forged units was determined by the forge's production plans. The tools were withdraw from production after 17054 forgings for UNIMAX steel currently used and after 23078 forgings for tools with hybrid layer due to worn out. After these amounts of pieces the forging failed the quality control of dimensions and surface appearances.

Since the number of the studied tools is small it is difficult to draw conclusions about how the wear mechanisms change with the number of forgings, but one can identify the dominant mechanisms in the whole process.

Research methodology

In order to determine wear in the particular places on the tools a GOMATOS II optical scanner was used. Unfortunately, one of the scanner's limitations is that it cannot be used to measure deep holes. Therefore prior to the scanning of the worn out tools the latter were cut in two in order to reveal their inner surfaces (Fig. 4a).

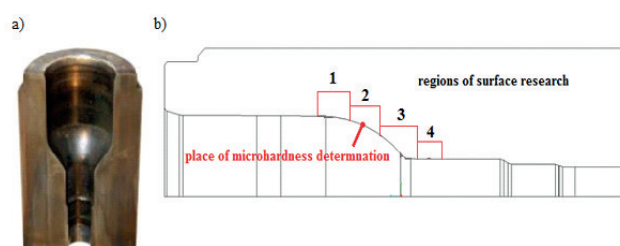

Fig. 4. The tools a) half of die and b) Longitudinal section of die with marked places where microhardness and structure of the working surfaces were analysed

The data acquired from the scanned objects (the scanned working surfaces of the dies used to forge CV joints) were compared with the original shape of the tools prior to work. A CAD model was used the reference model. The results, in the form of colour maps showing deviations relative to the nominal dimension (the CAD model) were analysed.

The microhardness HV 0.1 were determined in the point marked by red in the Fig. 4b whereas the structure of the working surfaces of the tools were examined using a TESCAN VEGA 3 scanning electron microscope in 4 regions.

3. Researched results

3.1 Analysis of die wear mechanisms in second operation of forging constant-velocity joint made of UNIMAX steel without hybrid layers

Fig. 5 presents the results of scanning the tools after a specified number of forged units with comparison with CAD model.

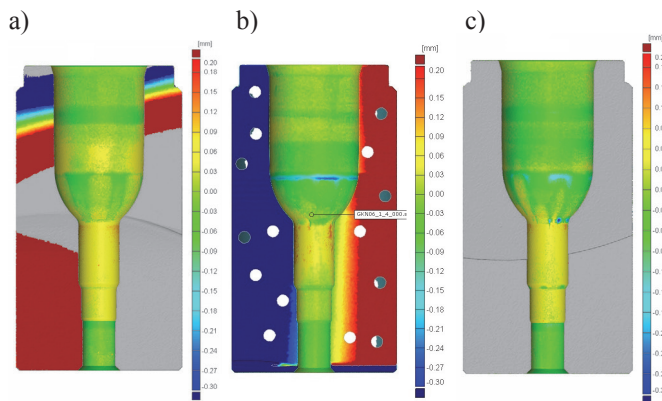

Fig. 5. Comparison of scanned images of die after a) 7044 b) 8371 and c) 17054 forgings with CAD model

No significant geometrical material loss was found of the die after 7044 forgings. After 8371 forgings the heaviest wear of the die was found to occur in the place of transition of the cylindrical part into the arched part where the so-called step forms. In addition, in the part where the forging's leg is formed one can discern traces of material (possibly oxides of the material being formed and remnants of the lubricant) adherence (Fig. 5b). Similarly as after 17054 forgings, one can see traces of wear on the die in the place of transition of its cylindrical part into its arched part, but the amount of this wear is smaller (fig. 5c). In the area of the first reduction in cross section also traces of longitudinal cracks are visible. The cracks will be described in detail later in this work. The measurements performed by means of the optical scanner showed that regardless of the number of forged units, the heaviest wear occurs in the place where the reduction in cross section begins, i.e. in the place of transition of the die's cylindrical part into its arched part. The heaviest wear in this area was found to occur in the die used to forge 8371 pieces. This was due to the fact that this die was characterized by the lowest hardness (Fig. 6). Moreover, material adherence in the part in which the forging's leg is formed was observed for all the tools regions of surface research

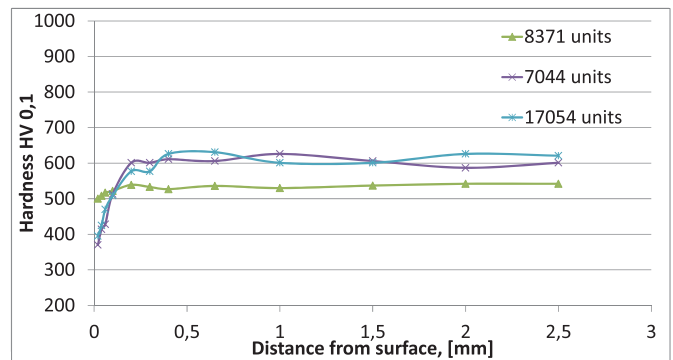

Fig. 6. Profiles of HV 0.1 microhardness on longitudinal cross section of tools

Description of changes in surface layer

After the forging of 7044 units a single large crack and a network of fine cracks (extending mainly circumferentially) with small spalls are visible in area 1 (Fig. 7a). In the die after 8371 forging cycles a “step” forms in the area of transition of the circular part into the arched part (fig. 7b), which is confirmed by measurements performed using the optical scanner. Wear in this place amounts to about 0.2 mm. Moreover, above and below the “step” one can see a network of fine cracks running circumferentially. The die's surface in this area after the forging of 17054 pieces is covered with a layer of oxides, which makes examination difficult (Fig. 7c), but the network of fine cracks is still visible.

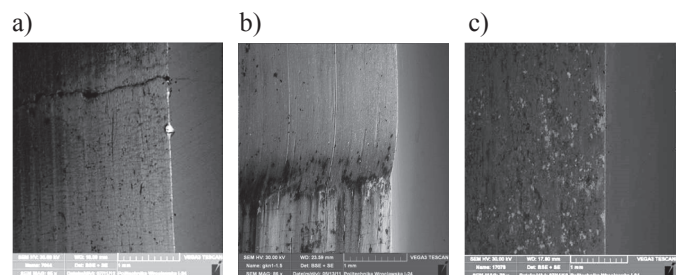

Fig. 7. Working surface in area 1 of dies after forging: a) 7044 units, b) 8371 units, c) 17054 units

A network of fine cracks (mainly circumferential) is also visible in area 2 (Fig. 8).

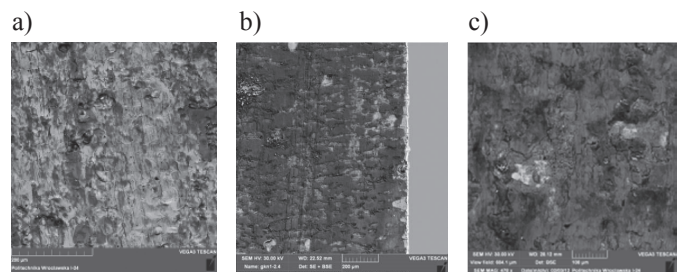

Fig. 8. Working surface in area 2 of dies after forging: a) 7044 units, b) 8371 units, c) 17054 units

In the place where the reduction in cross section is largest (area 3) a longitudinal crack, caused by the heaviest circumferential stresses, appears already after the forging of 7044 units (Fig. 9a). Similar cracks as for the die after the

forging of 7044 pieces are observed for the die after 8731 cycles (Fig. 9b). A network of cracks typical for thermomechanical fatigue (fig. 9c) appears below the radius of reduction. As the number of forged units reaches 17054 units, the material weakens, which results in the development of cracks and the formation of grooves along the longitudinal cracks on the surface of the die (fig. 9d).

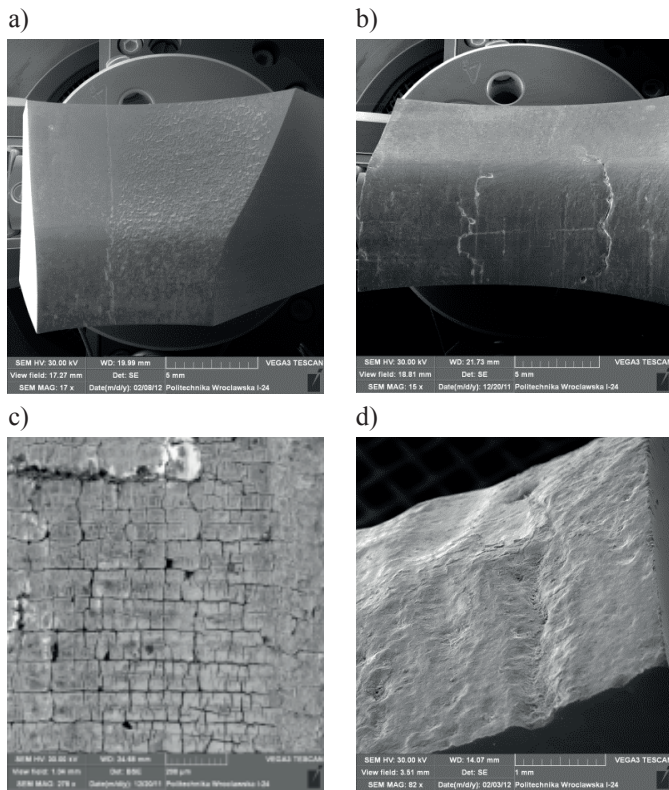

Fig. 9. Working surface in area 3 of dies after forging of: a) 7044 units, b) 8731 units, c) and d) 17054 units

Below the radius of reduction in the cylindrical part (area 4) after 7044 forgings a network of fine thermomechanical cracks (Fig. 10a) is visible. On the cross section one can also discern a single longitudinal crack, which probably developed in area 3 and grew larger with the number of die work cycles. The die's surface in this area looks similarly after the forging of 8731 units: a network of thermomechanical cracks and a distinct longitudinal crack filled with scale are visible (Fig. 10b). After 17054 forgings the die's surface in this area is covered with a thick layer of oxides whereby the network of cracks is poorly visible. Grooves form along the longitudinal cracks (Fig. 10c).

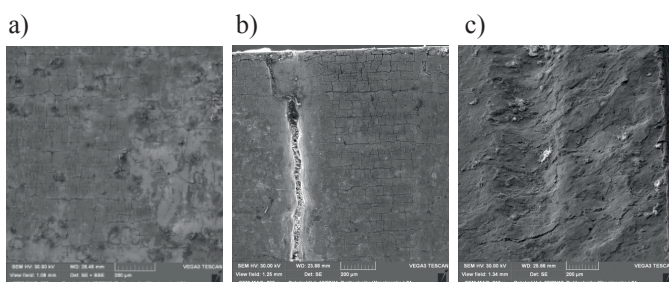

Fig. 10. Working surface in area 4 of dies after forging: a) 7044 units, b) 8731 units and c) 17054 units

The studies have shown mechanical fatigue, thermomechanical fatigue and to a lesser degree abrasive wear to be the dominant destructive mechanisms in the dies used in the second operation of forging the CV joint housing.

As a result of the cyclical changes in temperature in the course of forging the surface layer of the die alternately expands and contracts which leads to the development of a network of thermal cracks. Under cyclically changing mechanical loads the network expands into a network of thermomechanical cracks, visible in nearly all the examined areas.

The network of thermomechanical cracks contributes to stress concentration, which combined with cyclically changing large circumferential stresses in the die may lead to mechanical fatigue and damage of the latter. Also the presence of scale contributes to the growth of cracks. Scale in a crack may act as a "wedge". This wear mechanism is most intensive in area 3 where the largest reduction in the cross section of the forging and the greatest hoop stresses occur.

The material loss determined by scanning the tools, and the microscopic examinations show that in comparison with the other destructive mechanisms, abrasive wear is very small. Only in area 1 abrasive wear results in the formation of a "step". It has also been found that abrasive wear is a secondary mechanism relative to the other destructive mechanisms, e.g. to the formation of grooves along cracks developing as a result of thermomechanical fatigue. The material in these areas is weakened and the hard oxides formed as a result of high-temperature oxidation act as an abrasive whereby ever larger grooves form in the next cycles.

The studies have unequivocally shown that abrasive wear is not the dominant mechanism in the investigated process, which to some extent contradicts the generally held view according to which abrasive wear dominates in hot and semi-hot forging processes.

3.2 Analysis of die wear mechanisms in second operation of forging constant-velocity joint made of UNIMAX steel with nitrided/PECVD coating.

In order to increase the resistance of the dies to mechanical fatigue, thermomechanical fatigue and abrasive wear, they were coated with a hybrid layer of the nitrided layer/PECVD coating type.

The effect of the hybrid layer of the nitrided layer/PECVD coating type on the durability of dies used in the second operation of forging the CV joint housing was studied by carrying out operational tests. Dies made of steel UNIMAX, in their original shape, coated with a hybrid layer of the nitrided layer/PECVD coating type were tested.

The hybrid layer applied to the tested tools had been designed and produced in the Fraunhofer Institute for Surface Engineering and Thin Films in Germany. The multilayer coating is based on Ti-B-N and it was produced using the PN 100/150 device made by RÜBIG. Procedure is described in [19]

Fig. 11 shows a SEM image of the coating, which consists 25 Ti-TiBN-TiB₂ layers with an overall thickness of about 2-3 μm and a hardness of 3200-4200 HV0.005. Moreover, the coating is characterized by thermal stability in a range of 500-700°C.

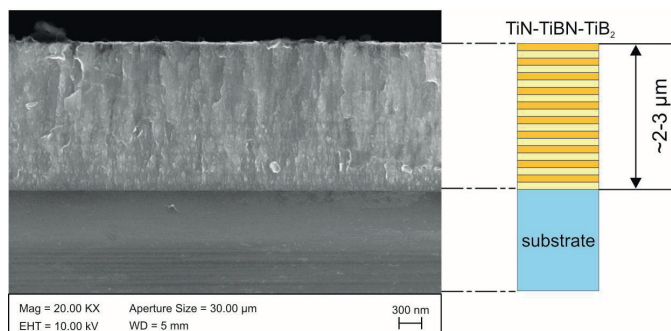

Fig. 11. Image of applied coating

Assessment of hybrid layer effect on durability of tested tools

The tools coated with the hybrid layer of the nitrated layer/PECVD coating type were subjected to operational tests in the industrial conditions of the GKN Polska in Oleśnica. In the operational tests, the tools coated with the hybrid layer were used to forge 5000 and 23078 units.

Results of scanning the tools with applied hybrid layer

The measurements of the tools performed using the optical scanner were confirmed by the macroscopic examinations which showed very small wear of the tools coated with the hybrid layer after the forging of 5000 units (Fig. 12a). Material adherence occurs, but it is much less intensive than in the case of the previously analyzed tools without the hybrid layer.

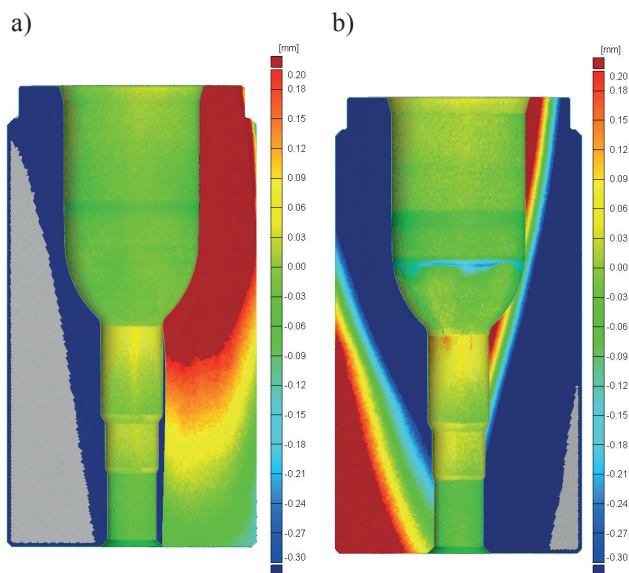

Fig. 12. Comparison of scanned images of die after a) 5000 and b) 23078 forgings with CAD model

After the forging of 23078 units a material loss in the place of transition of the cylindrical part into the arched part is clearly visible (a "step" forms there) (Fig. 12b). The wear in this place is not uniform on the whole circumference and it is considerably smaller than in the case of the dies without the coating. Nonuniform wear can also be noticed below the "step" on the die's arched part. This form of wear is probably due to the nonuniform lubrication and cooling of the die.

Traces of material adherence are visible below the first reduction step. For a smaller number of forgings material adherence did not occur.

According to the microhardness distributions for the dies with the hybrid layer, there is no significant decrease in microhardness during the whole process [Fig. 13].

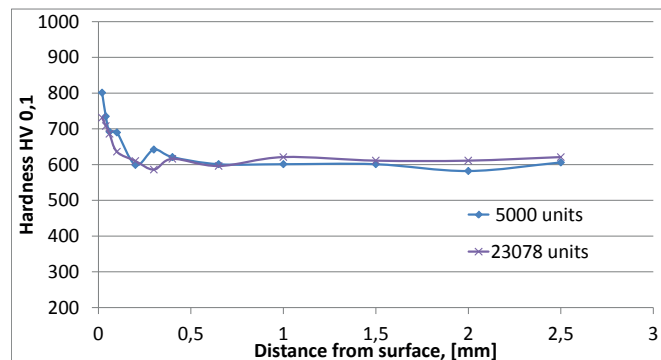

Fig. 13. Profiles of microhardness HV 0.1 on longitudinal section of tools coated with hybrid layer

Description of changes in surface layer of dies coated with hybrid layer

After the forging of 5000 units one can notice irregular fine cracks and shallow longitudinal cracks in area 1 (Fig. 14a). The fine cracks occur only in the circumferential direction.

After 23078 forging cycles a distinct "step" is visible in the place of transition of the circular part into the arched part (Fig. 14b). The "step" is also visible in the surface scan. Under a larger magnification short fine circumferential fractures, concentrated mainly along cracks become visible (Fig. 14c). One can suppose that they are thermal fractures caused by the cyclic changes in die temperature in the neighbourhood of cracks, i.e. where the Ti-B-N coating (constituting a thermal insulation) was damaged.

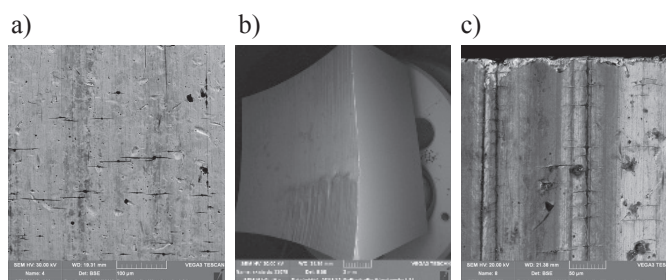

Fig. 14. Working surface in area 1 of dies with hybrid layer after forging: a) 5000 units, b) and c) 23078 units

After the forging of 5000 units traces left after finishing are visible in the arched part (area 2). After the forging of 23078 units the traces left after finishing are no longer visible (Fig. 15c). The grooves left after finishing are the place of initiation of fine circumferential cracks appearing already after 5000 forging cycles (Fig. 15b). In the course of further operation the size and number of cracks increase (Fig. 15d). The cracks on the surface of the tools coated with Ti-B-N do not form a typical network of thermomechanical cracks, characteristic of the previously studied uncoated tools.

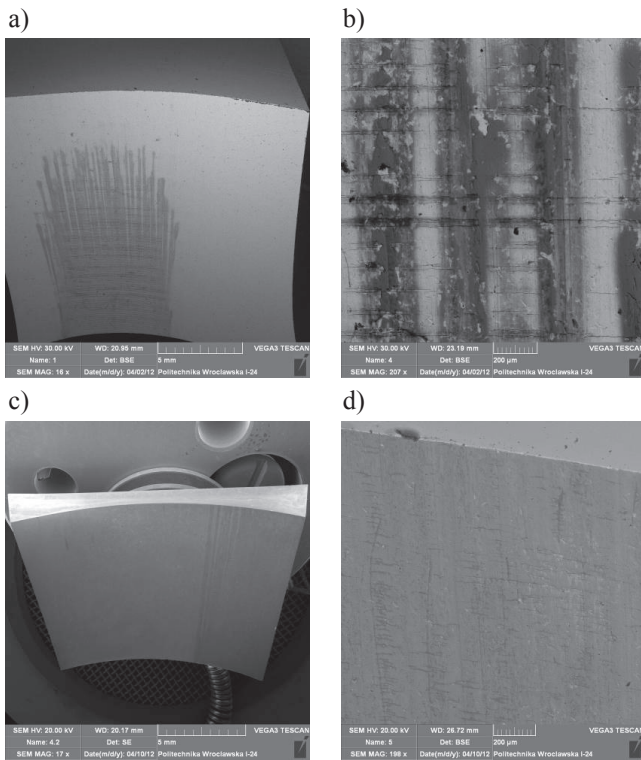

Fig. 15. Working surface in area 2 of dies with hybrid layer after forging: a), b) 5000 units, c), d) 23078 units

After the forging of 5000 units traces left after machining are visible in area 3 above the radius of reduction (Fig. 16a). Despite the coating's high resistance to high-temperature oxidation, after 23078 forging cycles a layer of oxides forms on the surface of the die, making observation difficult. After 5000 forgings, a network of typical thermomechanical cracks begins to form within the radius of reduction and below it (Fig. 16b). Under a larger magnification the circumferential cracks which appeared earlier become visible. New cracks originate from them in the longitudinal direction, later forming a dense network of thermomechanical cracks (Fig. 16c). The network of cracks grows larger with the number of forged units. After 23078 forgings deep circumferential cracks are visible on the die's longitudinal section (Fig. 16d). The cracks are straight (not inclined in the direction in which the deformed material flows) which indicates the absence of plastic deformations of the die's surface layer. As a result of material weakening and the action of cyclically variable large circumferential stresses the longitudinal cracks grow larger. This is accompanied by the spalling of the material in the vicinity of the cracks (Fig. 16e, f).

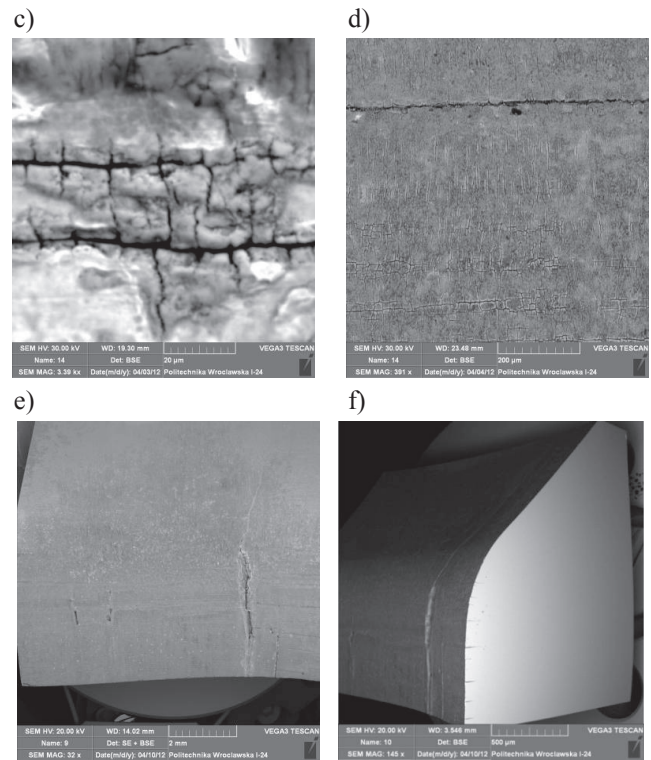

Fig. 16. Working surface in area 3 of dies with hybrid layer after forging: a), b), c), d), 5000 units, e), f), 23078 units

Regardless of the number of forgings, the surface in area 4 of the dies looks similar and shows no traces of wear (Fig. 17). Only on the sample cut out from the die after 23078 forgings one can see a longitudinal crack, which probably originates in area 3.

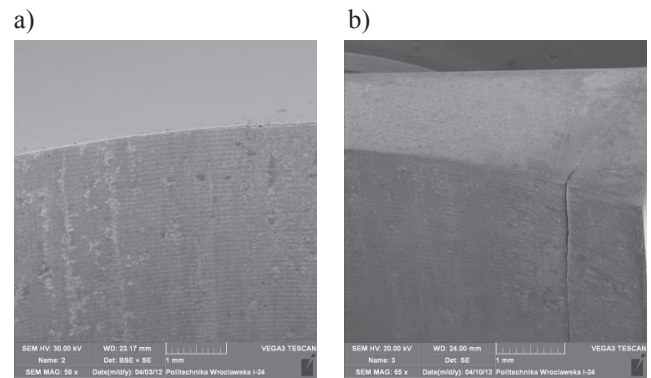
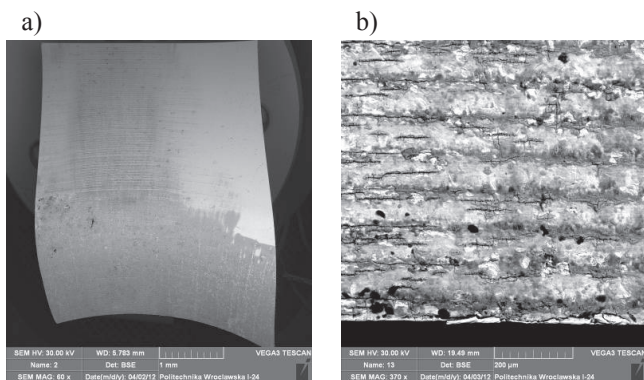

Fig. 17. Working surface in area 4 of dies with hybrid layer after forging: a) 5000 units, b) 23078 units.



4. Conclusions

The material loss determined by scanning the tools, and the microscopic examinations show that in comparison with the other destructive mechanisms, abrasive wear is very small. Only in area 1 abrasive wear results in the formation of a "step". It has also been found that abrasive wear is a secondary mechanism relative to the other destructive mechanisms, e.g. to the formation of grooves along cracks developing as a result of thermomechanical fatigue. The material in these areas is weakened and the hard oxides formed as a result of high-

temperature oxidation act as an abrasive whereby ever larger grooves form in the next cycles.

The studies have unequivocally shown that abrasive wear is not the dominant mechanism in the investigated process, which to some extent contradicts the generally held view according to which abrasive wear dominates in hot and semi-hot forging processes.

Studies have demonstrated that in the analysis of forging process is difficult to speak separately about each destructive as all mechanisms overlap. However, it seems that the most critical, accelerating other degradation mechanisms is the thermo-mechanical fatigue.

Measurements of the dies coated with the hybrid layer, performed using the optical scanner showed that the dies wear out less than the ones without the hybrid layer. Moreover, material adherence is smaller in the former case. Examinations of the surface layer showed that the destructive mechanisms are less intensive than in the case of the currently used tools. For tools with hybrid layer after the forging of 5000 units traces left after machining are still visible in some areas.

Acknowledgments

This research was carried out as part of project **PBS2/A5/37/2013** funded by the The National Centre for Research and Development.

REFERENCES

- [1] M. Hawryluk, M. Marcinka, G. Misiun, Possibilities of investigating abrasive wear in conditions close to those prevailing in industrial forging processes, *Eksploatacja i Niezawodność – Maintenance and Reliability* **16**, 4, 600-607 (2014).
- [2] Z. Gronostajski, M. Kaszuba, M. Hawryluk, M. Marciniak, M. Zwierzchowski, A. Mazurkiewicz, J. Smolik, Improving Durability of Hot Forging Tools by Applying Hybrid Layers, *Metalurgija* **54**, 4, 687-690 (2015).
- [3] T. Altan, G. Ngaile, G. Shan, Cold and hot forging: fundamentals and application, ASM International (2005)
- [4] E. Doege, R. Bohnsack, Closed die technologies for hot forging, *Journal of Materials Processing Technology* **98**, 2, 165-170 (2000).
- [5] Z. Gronostajski, M. Kaszuba, Hawryluk, M. Zwierzchowski, A review of the degradation mechanisms of the hot forging tools, *Archives of Civil and Mechanical Engineering* **14**(4), 528-539 (2014).
- [6] Z. Gronostajski, M. Hawryluk, J. Krawczyk, M. Marciniak, Numerical modelling of the thermal fatigue of steel WCLV used for hot forging, *Eksploatacja i Niezawodność – Maintenance and Reliability* **15**(3), 129-133 (2013).
- [7] D. Pocięcha, B. Boryczko, J. Osika, M. Mroczkowski, Analysis of tube deformation process In a New pilger cold rolling process, *Archives of Civil and Mechanical Engineering* **14**, 3, 376-382 (2014).
- [8] A.K. Sahoo, S. Pradhan, A.K. Rout, Development and machinability assessment in turning Al/SiCp-metal matrix composite with multilayer coated carbide insert using Taguchi and statistical techniques, *Archives of Civil and Mechanical Engineering* **13**(1), 27-35 (2013).
- [9] L. Major, Wear mechanisms of multilayer TiN/Ti/a-C:H coatings investigated by transmission electron microscopy technique, *Archives of Civil and Mechanical Engineering* **14**(4), 615-6215 (2014).
- [10] K.-T. Rie, Recent advances in plasma diffusion processes, *Surface and Coatings Technology* **112**(1-3), 56–62 (1999).
- [11] J. Adamus, J.M. Lackner, Ł. Major, A study of the impact of anti-adhesive coatings on the sheet-titanium forming processes, *Archives of Civil and Mechanical Engineering* **13**(1), 64-71 (2013).
- [12] E. Ryuichiro, K. Katsuaki, Failure analysis of hot forging dies for automotive components, *Engineering Failure Analysis* **15**(7), 881–893 (2008).
- [13] J.-D. Kamminga, P.F.A. Alkemade, G.C.A.M. Jassen, Scratch test analysis of coated and uncoated nitrided steel, *Surface and Coatings Technology* **177**, 284–288 (2004).
- [14] A. Mazurkiewicz, J. Smolik, A. Zbrowski, J. Kacprzyńska, Innovative technical solutions for evaporation of multilayer coatings by EB-PVD method, *Archives of Civil and Mechanical Engineering* **14**(2), 250-254 (2014).
- [15] J. Smolik, Rola warstw hybrydowych typu warstwa azotowana/powłoka PVD w procesie zwiększania trwałości matryc kuzniczych, *WITE* (2007).
- [16] B. Navinsek, P. Panjan, F. Gorenjak, Improvement of hot forging manufacturing with PVD and DUPLEX coatings, *Surface and Coatings Technology* **137**, 255–264 (2001).
- [17] Z. Gronostajski, M. Hawryluk, M. Kaszuba, et al., Die profile optimization for forging constant velocity joint casings, *Archives of Metallurgy and Materials* **56**(2), 551-558 (2011).
- [18] Z. Gronostajski, M. Hawryluk, M. Kaszuba, P. Sadowski, S. Walczak, D. Jabłoński, Measuring & control system in industrial die forming processes. *Eksploatacja i Niezawodność – Maintenance and Reliability* **13**(3), 62–69 (2011).
- [19] H. Paschke, M. Stueber, C. Ziebert, M. Biströn, P. Mayrhofer, Composition, microstructure and mechanical properties of boron containing multilayer coatings for hot forming tools, *Surface and Coatings Technology* **205**(2), S24–S28 (2011)

